

heatmiser®



Model: **TM-1 / TM1-N**

Model: TM-1 / TM1-N





Table of Contents

Product Image	1
Table of Contents	2
Installation Procedure	3-4
LCD Display	5-6
Operating Modes	7
Setting the Operating Mode	8
Setting the Clock	9
Setting the Communication Number (TM1-N ONLY)	10
Locking the Time Clock	11
Programming 5/2 Day Time Clock Mode	12
Programming 7 Day Time Clock Mode	13 - 14
Setting Countdown Mode	15
Time Clock Override	16
Holiday Programming	17
Factory Reset	18
Wiring Diagrams	19 - 21



Installation Procedure



Do

Mount the time clock at eye level.

Read the instructions fully so you get the best from our product.



Don't

Do not push hard on the LCD screen as this may cause irreparable damage.

This time clock is designed to be flush mounted and requires a back box of 35mm (minimum depth) to be sunk into the wall prior to installation.

Step 1

Carefully separate the front half of the time clock from the back plate by placing a small flat head terminal driver into the slots on the bottom face of the time clock.

Step 2

Place the time clock front somewhere safe.

Terminate the time clock as shown in the diagrams on pages 19-21 of this booklet.

Step 3

Screw the time clock back plate securely into the back box.

Step 4

Clip the front of the time clock back onto the time clock back plate.

1



2



3

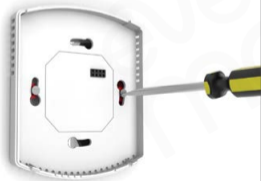

4



1
Sun • Mon Tue Wed Thu Fri Sat

6
00:00h

5
TIMER ON
TIMER OFF

WAKE LEAVE RETURN SLEEP



1. Day Indicator - Displays the current day.
2. Holiday Indicator - Displayed when the programmer is in holiday mode.
3. Program Cycle Indicator - Displayed during programming only to show which period is being altered.
4. Keypad Lock Indicator - Displayed when the keypad is locked.
5. Timer Status - Displays the current status of the timed output.
6. Clock - Digital clock display in 24h format.

M Operating Modes

The time clock has three main operating modes.

MODE	DESCRIPTION
00	5/2 Day Time Clock In this mode, you can program 4 switching times for the weekdays and 4 different switching times for the weekend.
01	7 Day Time Clock In this mode, you can program 4 switching times for each day of the week.
02	Countdown Timer In this mode, the TM1 will activate the output during the countdown period.

The time clock can be used to control various electrical devices in and around your home e.g. lighting, electric towel rails, hot tubs, sauna's etc.







Refer to the manufacturer instructions for wiring to these devices.

Common time clock wiring requirements are shown in the diagrams on pages 19 - 21.



Setting the Operating Mode

To select the mode, follow these steps.



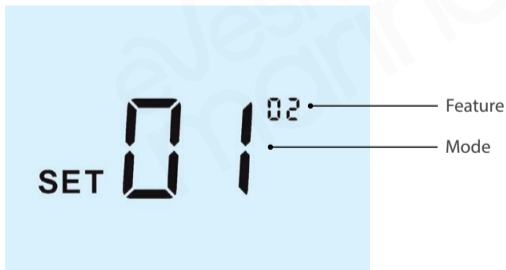





- Press and hold the Power button to turn the time clock OFF 
- Press and hold the Clock button until the display appears as shown below ... 
- Press the Clock button again until you see a small number 02 on screen 
- Use the Up/Down buttons to select the mode you require 
- Press A to confirm settings 
- Press the Power button once to turn the time clock back ON 





Setting the Clock

To set the clock, follow these steps.



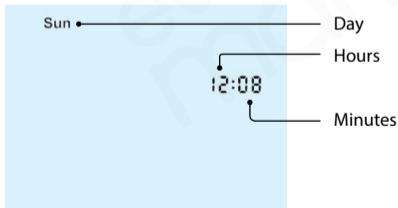

- In Countdown mode, press the Clock button once 
- In either 5/2 or 7 Day mode, press the Clock button twice 
- Use the Up/Down buttons to set the hours 
- Press H to confirm settings 
- Use the Up/Down buttons to set the minutes 
- Press H to confirm settings 
- Use the Up/Down buttons to set the day of the week 
- Press A to confirm settings and return to the main display 





Communication Setting (TM1-N Only)

To set the communications number, follow these steps.

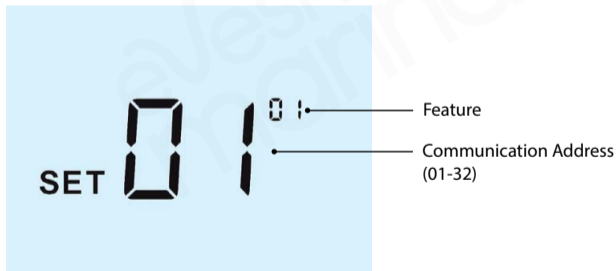

- Press and hold the Power button to turn the time clock OFF 
- Press and hold the Clock button until the display appears 
- The display will appear as shown below showing feature number 01
- Use the Up/Down buttons to set a unique communication address 
- Press A to confirm settings 
- Press the Power button once to turn the time clock back ON 





Locking the Time Clock

The time clock has a keypad lock facility. To activate the lock follow these steps.

- Press and hold the A and Down buttons together for 10 seconds 
- You will see the lock symbol appear on screen 
- To unlock, repeat the steps above until the lock symbol disappears.

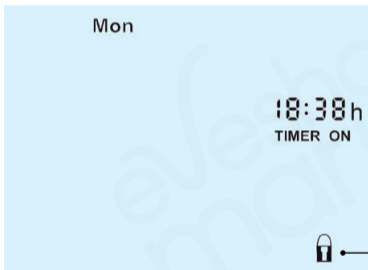









Keypad Lock Indicator

The keypad lock indicator is only visible when the lock is active.

















5/2 5/2 Day Time Clock Mode



To program the switching times, follow these steps.

- Press the Clock button once 
- You will see Mon Tue Wed Thu Fri displayed on screen.
- Use the Up/Down buttons to select the TIMER ON for the WAKE switching period  
- Press H to confirm settings 
- Use the Up/Down buttons to select the TIMER OFF for the WAKE switching period  
- Press H to confirm settings 
- Repeat these steps for LEAVE, RETURN and SLEEP levels.
- For unused periods set the time to -- : -- and the time clock will ignore the setting.
- You will now see Sat Sun displayed on screen and can repeat for the weekend.
- Press A to confirm settings and return to main display 

7 7 Day Time Clock Mode

To program the switching times, follow these steps.

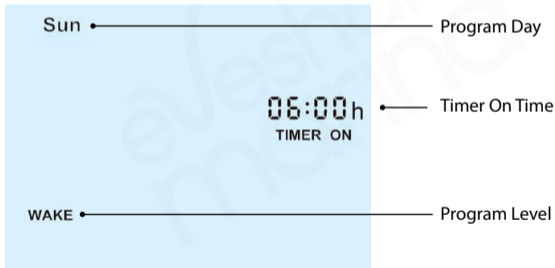

- Press the Clock button once, you will see Mon displayed 
- Use the Up/Down buttons to scroll to the day you want to program  
- Press A to select 
- Use the Up/Down buttons to set the TIMER ON time for the WAKE switching period  
- Press H to confirm settings 
- Use the Up/Down buttons to set the TIMER OFF time for the WAKE switching period  
- Press H to accept display values and confirm settings 
- Use the Up/Down buttons to set the ON time for the LEAVE period  
- Press H to confirm settings 
- Use the Up/Down buttons to set the OFF time for the LEAVE period  
- Press H to accept display values and confirm settings 
- Repeat these steps for the RETURN and SLEEP levels.

- For unused periods set the time to -- : --
- When WAKE, LEAVE, RETURN & SLEEP periods have been programmed, use the Up/Down keys to select the next day to program 
- Press A to accept and repeat the programming steps 
- Press A to confirm settings and return to main display 





Countdown Mode

- Use the Up/Down buttons to set the countdown duration  
- Press A to confirm settings 
- Hold For will appear showing the time left.

When Hold For is displayed on screen, the output will be active.

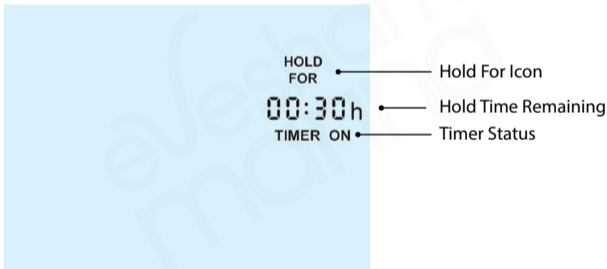

To cancel a countdown period, reduce time to 00:00.



Timer Override

The time clock is able to override its current timer status.

If the TM1 is in the Timer ON mode – pressing A will switch it to Timer OFF **A**

(TIMER OFF will flash to inform you the programmed output has been overridden)

The TM1 will return to the program at the next programmed time.







Holiday

The holiday function allows you to quickly enter a holiday setting.

During a holiday, the time clock will maintain TIMER OFF.

At the end of your holiday, the time clock will revert back to the programmed setting.

- Press H once (you will see the suitcase displayed on screen) 
- Use the Up/Down buttons to enter the number of days holiday 
- Press A to confirm settings 

The display will show a suitcase indicating the time clock is in holiday mode.

Note: A holiday period does not start until 00:00 the next day. For example, if you set a holiday period on Friday for 2 days, Saturday will be counted as the first day and the time clock will revert back to the programmed schedule at 00:00 on Monday.

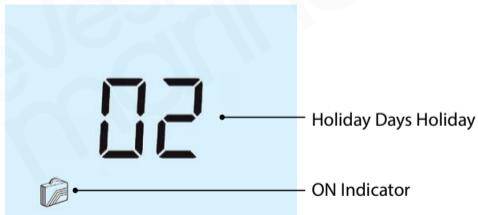



To cancel, follow the same steps but reduce the holiday duration to 00 days.



Factory Reset

The time clock has a reset function to restore all settings to their factory defaults.

To perform a factory reset, follow these steps.

- Press and hold the Power button to turn the thermostat OFF 
- Press and hold the Power and Up buttons together until the LCD powers up. All of the icons will be displayed on screen 
- When the icons have disappeared from the screen, the thermostat has been successfully reset.
- Press the Power button once to turn the time clock back ON 

All icons displayed simultaneously.



Factory reset is complete.

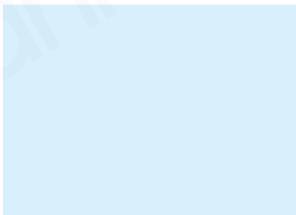



Wiring Diagram - TM1 Switched Live Output

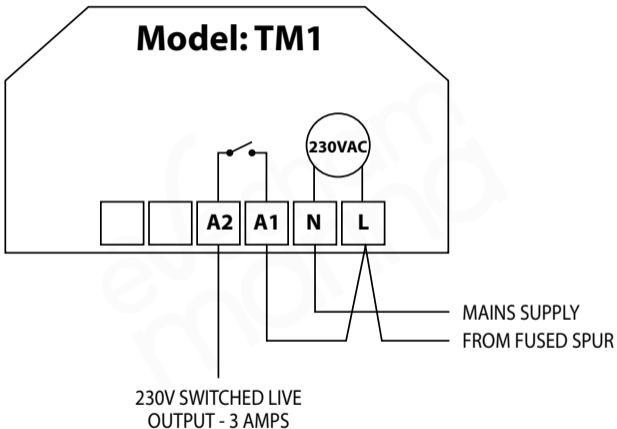



Wiring Diagram - TM1 Switched Output Voltfree

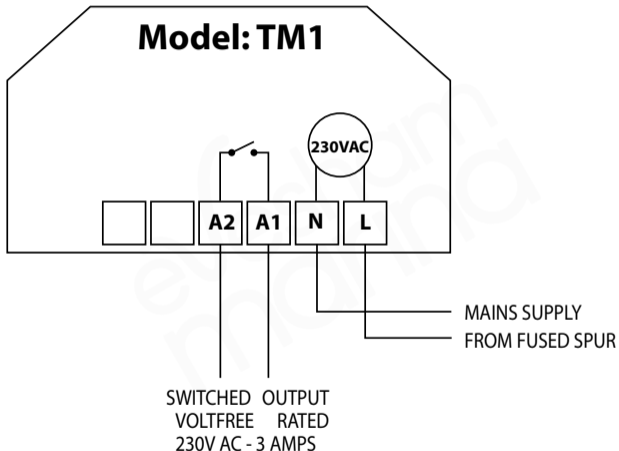



Wiring Diagram - TM1-N to UH8-N

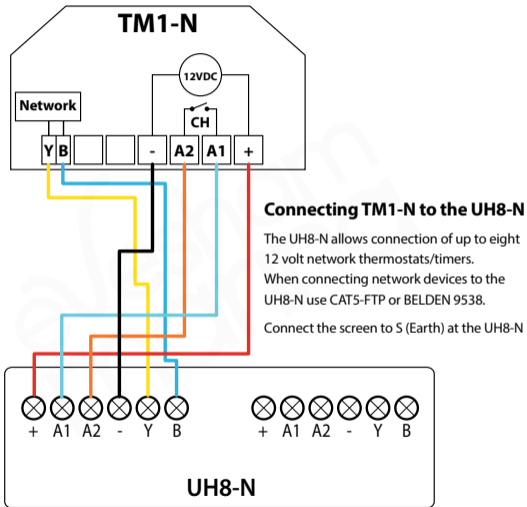



Notes

The time clock can be used to control various devices in and around your home e.g. lighting or towel rails.

Refer to the manufacturers instructions for wiring to these devices.

Common time clock wiring requirements are shown in the diagrams on pages 19-21.

.....

.....

.....

.....

.....

.....

.....

.....

.....

.....

.....

.....

.....

.....

.....

.....

.....

.....

.....

.....

.....

.....



Want More Information?

Call our support team on: +44 (0)1254 669090

Or view technical specifications directly on our website:
www.heatmiser.com



PDF



FAQ



Twitter: @heatmiseruk



Facebook: facebook.com/thermostats