



## 日本山崎 電熱水壺

SANKI Thermo Pot

### 使用說明書

Instruction Manual

SK-P550

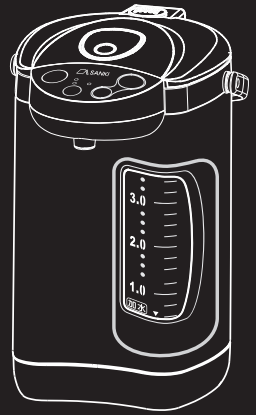

## 01

重要安全事項

Important Safeguards

## 02

產品部件

Part and Accessories

## 03

使用說明

How to use

## 04

清潔與保養

Care and Maintenance

## 05

技術規格

Technical Specifications

## 06

常見故障及處理

Troubleshooting

## 07

重要信息

Important Notices

### 本產品只供家居使用 For House hold use only

- 1 在使用之前請詳細閱讀「使用說明書」及「保用條款」，並妥為保存。  
Please read these instructions and warranty information carefully before use and keep them handy for future reference.
- 2 請必須依照本說明書內之指示安裝及操作。  
The appliance may only be installed and operated in accordance with these instructions for use.
- 3 產品如有任何技術規格更改不作另行通知。  
Specifications, designs and dimensions are subject to change without prior notice.

所有用戶必須於使用本產品前閱讀及了解以下重要安全事項，以免造成傷害或損壞本產品。

All users of the appliance must read and understand these safety precautions before operating to avoid personal injury or damage to the appliance.



**警告**

危險或不安全的使用可能會導致產品損壞，嚴重的人身傷害或死亡。

**Warning**

Hazards or unsafe practices that could result in appliance damage, serious personal injury, or death.

1. 本產品不能由身體、感官或精神有缺陷的人或缺乏經驗與知識的人使用(包括兒童)。除非有負責他們安全的人對其進行監督或指導。  
This appliance is not intended for use by persons (including children) with reduced physical sensory or mental capabilities, or lack of experience and knowledge, unless they have been given supervision or instruction concerning use of the appliance by a person responsible for their safety.
2. 在您連接產品電源之前，請確認本地電壓與產品所標示的電源電壓相符。  
Before plugging in the appliance, check that the electrical rating shown on the rating plate corresponds with your house electricity supply.
3. 必須將電源插頭插入有接地線的電源插座，並確保接地良好。  
T
4. 請勿使用損壞的電源線或電源插頭。手濕時請勿操作電源插頭或產品。  
Do not use a damaged power cord or plug. Do not handle the plug or the appliance with wet hands.
5. 請勿將本產品局部或完全浸泡於任何液體中或對機身澆水，以免引起短路或觸電。  
Never immerse the appliance in water or splash water onto the appliance to avoid risk of short circuit or electric shock.
6. 請不要在無水狀態下進行乾燒，這樣易損壞發熱管。  
DO NOT let the kettle boil dry, this may damage the heating element.
7. 若使用過程中水壺裡水量太少或不小心乾燒時，應及時拔掉電源線插頭。然後冷卻15分鐘，再注入冷水。  
Should you accidentally allow the kettle to operate without water, unplug from the power source immediately, and let the kettle cool down for 15 minutes before refilling with cold water.
8. 使用時，應放置於平穩及兒童不易觸及的地方，以防水壺翻倒傷人或損壞水壺。  
Ensure that kettle is used on a firm and flat surface where the children can't touch, this can prevent from overturning the kettle to damage the person or kettle.
9. 勿將本產品浸入水或其它液體中，以避免發生火災、漏電或危及人身安全。  
To protect against a fire, electric shock or personal injury, do not immerse cord, electric plugs or kettle in water or other liquids.
10. 開水煮沸後，不要接觸壺嘴噴出的蒸氣，也不要急於打開壺蓋，以免被蒸氣燙傷。  
While boiling water, avoid to contacting steam from the spout when water is boiling or just after it has switched off. Do not be anxious to uncover the lid to avoid being scalded by the hot water.
11. 在水壺沒有冷卻下來，需要重新灌水時，打開壺蓋時要小心。  
Be careful when opening the lid for refilling when the kettle is hot.
12. 使用時，不要讓兒童靠近產品拉扯電源線或敲碰水壺，以免被開水燙傷。  
DO NOT let children near the kettle when it is in operation. Do not let children pull on the power cord or touch the kettle to avoid getting scalded.
13. 本產品僅用於煮水，切不可用來裝咖啡、茶、酒精或化學物品。  
This product is only intended for boiling water. DO NOT use it for brewing coffee, tea, alcohol or chemicals.
14. 不要接觸高溫表面，以免被燙傷。  
Do not touch the hot surface to avoid scalding.
15. 當開關處於工作狀態時，不可移動水壺。  
Do not move the unit while the kettle is switched on.
16. 移動裝滿熱水的水壺時，應十分小心，以免被燙傷。  
Extreme caution must be used when moving an appliance containing hot water.

17. 當煮水時，保證壺蓋閉合，不可打開壺蓋，以免燙傷。  
Always ensure the lid is closed and do not lift it while the water is boiling. Scalding may occur if the lid is removed during the brewing cycles.
18. 如果水壺注水太滿，沸水可能噴出，導致燙傷。  
If the kettle is overfilled, boiling water may be ejected and may cause scalds.
19. 應照看好兒童，確保他們不玩耍本產品。  
Children should be under supervision to ensure that they do not play with the appliance.
20. 請勿如下動作，以免損壞電源線或電源插頭。  
Do not damage the power cord or plug as follows.
  - 置於發熱物件附近。Placing near the heating elements.
  - 強行加工、彎曲、扭曲、拉伸。Modifying, bending, twisting, pulling.
  - 將重物放在上面或捆成一束。Putting heavy objects on top, and bundling the power cord.
  - 拔掉電源插頭時，請勿拉扯電源線。Pull on the power cord when removing the plug from the socket outlet.
19. 請勿使用任何酸鹼性溶液噴向本機及清洗機器，以免引起觸電或損傷。  
Never clean the appliance with any acidic or alkaline liquids to avoid electric shock or appliance damage.
20. 請勿將包裝材料(塑料袋、卡紙、發泡膠等)放於兒童可觸及的地方，以免發生危險。  
Keep all packing materials, such as plastic bags, cartons and styrofoam, out of reach of children in order to avoid danger.
21. 如果電源線損壞，必須由授權的服務中心或合格的專業人員進行更換，以免發生危險。  
If the power cord is damaged, it must be replaced by authorized Service Center or similarly qualified person in order to avoid a hazard.
22. 若本產品有任何問題，請勿自行拆卸、修理或改裝，以免造成自身傷害。如要維修，請聯絡本公司或持牌之專業技術人員。  
Any servicing should be performed by an authorized service representative. Do not attempt to disassemble, repair or modify the appliance.
23. 請單獨使用額定值為 220V 的插座。  
Please use an independent socket outlet with the voltage of 220V.
24. 清潔機身及配件前，必先拔掉電源插頭，並待機身內部完全冷卻後方可進行。  
Before cleaning the body and accessories of the appliance, please unplug the power cord. Wait until the interior of the appliance cools down and then clean it.
25. 不能使用蒸汽清潔器。  
Cannot use steam cleaner.
26. 本產品為家用式電熱水壺，請勿用於商業或工業以及其他用途。  
This appliance is designed for household use only. It is not suitable for commercial / industrial use or for any other purposes.
27. 請遠離熱源，如散熱器、火、陽光直射等。  
Keep the appliance away from heat sources, for example, radiators, fires, direct sunlight, etc.
28. 如長期不使用本產品，請拔掉電源插頭並清潔機身，然後放回原包裝以免電器零件受潮或受損。  
When the appliance is not use for a long period of time, please unplug and clean it, then put back into the original packing box to avoid the electrical components being humidified or damaged.

## 警告 Warning :

- 請勿使用其他製造商的任何配件或零件，或非本公司建議之配件或零件。  
Never use any accessories or parts from other manufacturers or that SANKI does not specifically recommend.
- 如果您使用此類配件或零件，保養即會失效。  
If you use such accessories or parts, your guarantee becomes invalid.
- 本產品僅適用於家用。  
This appliance is intended for household use only.
- 如果不注意有關事項，可能會導致產品損壞。  
Failure to observe these cautions may result in damage to the appliance.

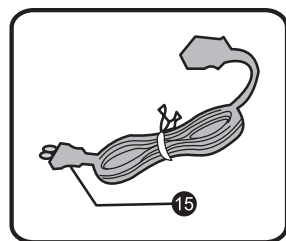
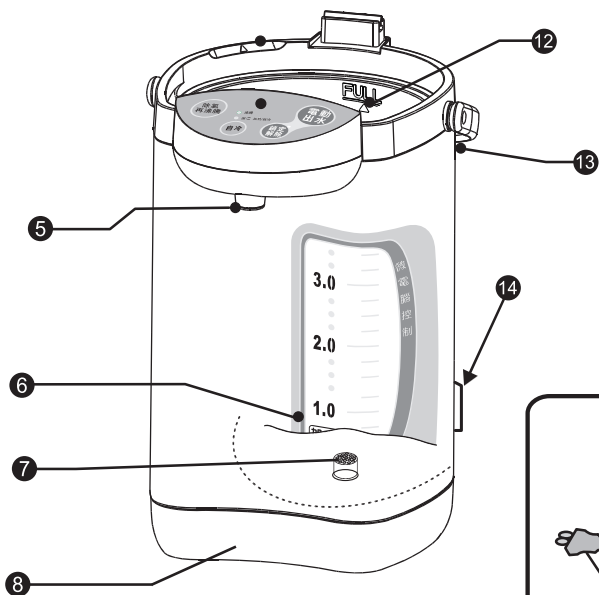
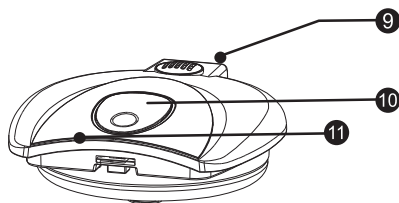
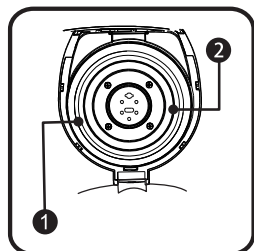

- |          |                  |          |                   |
|----------|------------------|----------|-------------------|
| 1. 內蓋密封圈 | Sealing ring     | 9. 蒸氣口   | Steam vent        |
| 2. 內蓋    | Inner cover      | 10. 開蓋按鈕 | Lid opening lever |
| 3. 進水口   | Water inlet      | 11. 上蓋   | Lid               |
| 4. 控制面板  | Control panel    | 12. 滿水標記 | MAX. water level  |
| 5. 出水口   | Dispensing spout | 13. 提手   | Handle            |
| 6. 水尺    | Water indicator  | 14. 電源插座 | Power plug        |
| 7. 出水過濾網 | Mesh filter      | 15. 電源線  | Power cord        |
| 8. 旋轉底盤  | Rotating base    |          |                   |

## 如何開啟上蓋

### How to open the lid

按開蓋按鈕，向上打開上蓋。  
Press the lid opening lever and open the lid.

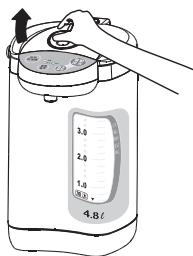

## 如何拆除上蓋

### How to remove the lid

按開蓋按鈕同時斜斜地往上拉，輕壓掙手。  
Pull it up slantwise while pressing the lid lever.

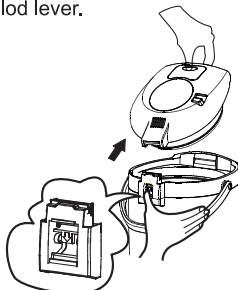

## 如何安裝上蓋

### How to install the lid

將上蓋轉軸安裝於卡槽。  
Install the upper cover shaft in the slot.

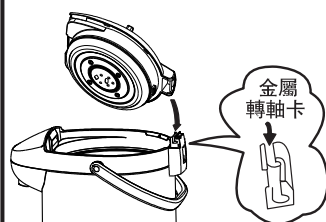

## 控制面板 Control Panel

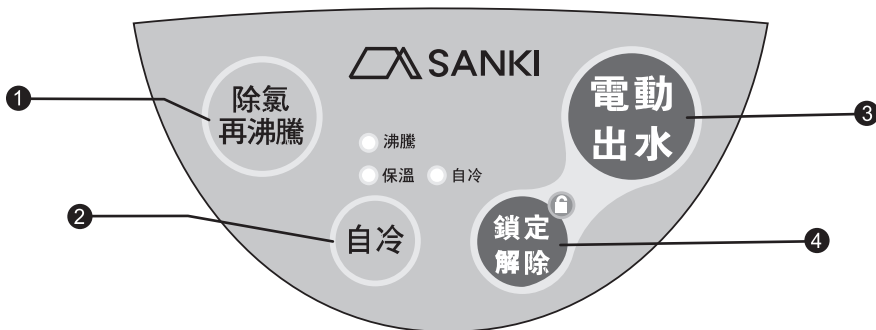

- |    |        |             |
|----|--------|-------------|
| 1. | 除氯再沸騰鍵 | Reboil key  |
| 2. | 自冷鍵    | Cooling Key |
| 3. | 電動出水鍵  | Pour Key    |
| 4. | 鎖定解除鍵  | Unlock Key  |

## 初次使用前注意 First use notice

- 初次使用前，建議先把水壺清潔乾淨，方法如下：  
Before first use of the kettle, clean the kettle according to the following steps:
- 將水壺注入適量的水，不能超過最大水位線，煲滾水後把水全部倒出，如上重複兩次即可使用。  
Fill the kettle with water up to the maximum water level, boil and discard, and repeat it twice.

## 注水 First use notice

- 注水時請勿超過最大水位線，以防沸水濺出。  
DO NOT fill the kettle over the maximum level, in case of water spilling out.
- 開機前，確保壺蓋緊密扣合好。  
Make sure the lid is closed firmly before connecting to power supply.

## 使用步驟 Operation Steps

- 請將電源線插緊在電源插座上，電熱水壺自動進入加熱狀態，加熱指示燈亮起，並於沸騰後進入保溫模式。  
Plug in both ends of the power cord tightly into the appliance and the power socket. The thermo pot will automatically enter the boiling progress. The boiling indicator will light up. The thermo pot will keep warm automatically after boiled.
- 水沸騰後，加熱指示燈會熄滅，保溫指示燈會長亮。  
After boiled, the boiling indicator will be off and the keep-warm indicator will light up
- 自冷功能指保溫功能暫停，電熱水壺會於水沸騰後進入自冷狀態，水溫會漸漸下降至室溫。  
Cooling mode means the keep-warm function is deactivated. The thermo pot will automatically enter the cooling progress. Water will cool down to room temperature gradually.
- 如需重新加熱室溫水，請先確定注水量超過最低水位線，否則應再次注水。  
按下 "除氯再沸騰" 鍵，加熱指示燈亮起。  
Please make sure the water level must above the refill level if you need to reboil the water, otherwise water should be refilled. Press "Reboil" key, the boiling indicator will light up.

## 電動出水 Electric Pump

- 先按 "鎖定解除" 鍵，解鎖指示燈亮起，把手杯放於出水口下方並按 "電動出水" 鍵出水。  
停止按鍵後約 15 秒後，電熱水壺會自動轉為鎖定狀態。  
Press "Unlock" key to unlock the appliance, the unlock indicator will light up. Place the cup under the dispensing spout and press "Pour" key to dispense water. The dispense function will be locked automatically after the key is released for 15 seconds.

清潔或保養產品前，請務必將電源線插頭拔掉。

Before cleaning and maintenance, unplug the power supply.

## 主機及上蓋 Main unit and lid

用濕軟布清潔水壺外表面，再用乾布擦乾即可。

Wipe over the exterior of the kettle with a soft damp.

## 內膽 First use notice

- 用濕海棉清洗。請勿使用去污粉、尼龍刷。

Clean with an wet sponge. Do not use polishing powder and scrub brush.

- 切勿用水直接沖洗或將機身浸入水中清洗。

Do not wash the unit directly with water or immerse the unit into water.

- 長時間不使用時，請拔出電源插頭。

Pull out the power cord when the the cooker will not be used for a long time.

- 切勿使用有機溶劑或苯等化學藥品擦拭。

Do not use organic solvents or any cleaning products that contain chemicals such as Benzene.

## 有關 "水垢" About "Scale"

使用過程中，水中含有鈣質等礦物成分會附於內膽及過濾網上。這稱為"水垢"，對人體無害。

While you are using the appliance, minerals contained in the water (like calcium) can get stuck on the inner container. This is called "scale" and it is harmless.

- 乳白色顆粒狀 (由鈣質產生) Milky-white gritty surface (caused by calcium)

- 白色或閃光的浮游物 (礦物成分的結晶體) White or glittering floating material (crystals of minerals)

- 茶色、灰色、綠色等變色 (塗層上的金屬離子)

Discoloration in the finish like dark brown, gray or green areas (metallic ion)

這些並非內膽本身的變色或腐蝕。

These are not discoloration or corrosion of the inner cotainer itself, nor are they flakes from the fluororesin covering .

## 使用檸檬酸清洗"水垢" Using citric acid to clean

- 將檸檬酸放入內膽內。(約80克)

Put citric acid in the inner container.(Around 80g)

- 加水至最高水位標示，將檸檬酸與水分充分混合後關上上蓋。

Insert water to the MAX water level mark and mix the citric acid with water well. Close the lid.

- 按 "除氣再沸騰" 鍵將水加熱。保溫約一小時後，把水全部倒掉，並用海棉或軟毛刷清洗內膽，然後用水沖洗。

Press "Reboil" Key to boil. Pour all the water out afterkeeping warm for around 1 hour. Clean the inner pot with a soft sponge or soft brush, then rinse by water.

- 請再次注水沸騰並把開水倒掉，以去除剩餘的檸檬酸。

Refill the water to boil again and pour out all water to reomve the remaining citric acid.

型號 Model	SK-P550
型號功率 Model	750W
頻率 Frequency	50 Hz
電壓 Voltage	220V
容量 Capacity	5.5 L
內膽材質 Inner pot material	SUS 304 不鏽鋼
機身尺寸 Product dimension	W220 x D220 x H360 mm
包裝尺寸 Packing dimension	W295 x D295 x H420 mm

\*如有更改，恕不通知 Specifications are subject to change without prior notice.



故障現象 Phenomenon	原因分析 Cause	處理方法 Solution
水有異味 Smell comes from the water	自來水含有消毒用氯氣，導致產生出異味 Tap water contains chlorine smell	可按“除氯再沸騰”鍵清除氯味 Press “Reboil” key to eliminate the chlorine smell
	電熱水壺的封閉包裝會產生輕微異味 The smell comes from the sealed packing	氣味會隨使用次數增加而消失。可使用檸檬片或檸檬酸文放於水中加熱，即可減退異味 The smell will disappear with time. Boiling water with lemon or citric acid to eliminate the smell
水中有白色或閃光物質 White or shiny particles in water	這是“水垢” Water scale of inner pot peeled off	請參考有關“水垢”及使用檸檬酸去除水垢 Please follow the instruction of “Using citric acid to clean” to remove the water scale
出水不暢順 Water dispense is not smooth	出水過濾網被堵塞 The water filter is blocked	用軟毛刷清洗過濾網 Clean the filter with a soft brush
水自動流出 Water dispenses automatically	注水超過最高水位指示線 Water is filled above the MAX water level	減少內膽水量低於最高水位指示線 Pour water out until water level is below the MAX water level
不能煲水 The appliance cannot boil water	未有連接插頭 The plug us not connected securely	重新連接插頭 Re-connect the plug properly

儘管本公司或其生產商受知會，在任何情況下本公司或其生產商將不須就任何聲明、承諾及保證的索償而負責及不會向客戶或第三方承擔任何因使用或未能使用此產品所帶來直接的、非直接的、非專業的、特殊的、偶然的、間接的、有代表性的或其他任何損傷的責任（包括但不限於身體的損傷、財產的損失、公司盈利的損失、公司運作受中斷）。在任何情況下本公司或其生產商所承擔之責任將不會超過此產品之購買金額。

IN NO EVENT SHALL OUR COMPANY OR THE SUPPLIER BE LIABLE TO YOU OR ANY OTHER PARTY FOR ANY DIRECT, INDIRECT, GENERAL SPECIAL, INCIDENTAL, CONSEQUENTIAL, EXEMPLARY OR OTHER DAMAGES ARISING OUT OF THE USE OR INABILITY TO USE THE PRODUCT (INCLUDING, WITHOUT LIMITATION, DAMAGES FOR INJURY, LOSS OF PROPERTY, BUSINESS PROFITS, BUSINESS INTERRUPTION) OR FROM ANY BREACH OF WARRANTY, EVEN IF OUR COMPANY OR SUPPLIER HAS BEEN ADVISED OF THE POSSIBILITY OF SUCH DAMAGES. IN NO CASE SHALL OUR COMPANY OR SUPPLIER'S LIABILITY EXCEED THE AMOUNT YOU PAID FOR THE PRODUCT.

產品如有任何技術規格更改不作另行通知。

Specifications, designs and dimensions are subject to change without prior notice.

## 環境保護 Environmental Tip

請勿將您的產品與其他家用廢棄物共同丟棄。

Never dispose of your product with other household waste.



請了解當地電子及電器廢棄物的垃圾分類相關法規。

Please inform yourself about the local rules on the separate collection of electrical and electronic products.

正確處理廢棄產品有助於避免對環境和人類健康帶來負面影響。

The proper disposal of your old product helps to prevent potentially negative consequences on the environment and human health.



[www.sanki.hk](http://www.sanki.hk) 日本山崎電器(國際)有限公司

## 產品保用條款及細則

自購買產品日期起12個月之內(註1)，日本山崎將為香港及澳門客戶提供免費保用服務。本保用須受下條款及細則約束：

1. 貴戶於購買產品後可享有一年原廠保用，客人只需於把收據及送貨單(如有)電郵至 [csd@sanki.hk](mailto:csd@sanki.hk) 即可。
2. 用戶於享用免費保用時，必須出示購買發票正本(或其他購機證明)以確認資料，否則本公司有權拒絕提供任何保修服務。
3. 未能出示購買發票正本者，將不獲免費維修服務。
4. 本保用只限產品在一般正常使用情況下方為有效。
5. 在合理情況下，本公司有權選擇維修或更換配件或其損壞之部份一件。
6. 本公司由購買日起一年內提供免費保用服務。於保用期內，如需要更換零件，本公司酌情並另作收費。
7. 保用期內，大型電器產品(註2)將由日本山崎認可技術人員免費上門維修(註3)；其他小家電則須由用戶自行運送至本公司維修中心進行維修，相關運輸費用由用戶負責。
8. 下列情況下，用戶之保用資格將自動失效：
  - 一 購買發票有任何非認可之刪改
  - 一 產品經非本公司認可之第三者改裝或加裝任何配件一機身編號被擅自塗改、破壞或刪除
  - 一 產品被轉售或轉讓予他人
  - 一 保用登記資料不正確或更改後未有通知本公司
9. 保用範圍並不包括：
  - 一 上門安裝、檢驗、維修或更換零件之人工及一切運輸費用(大型電器上門維修除外)
  - 一 非隨機配件或任何輔助裝置(如塑膠或損耗件等)(註4)
  - 一 人為損壞(如不當電源供應、非本公司認可之安裝、不依說明書指示操作、疏忽使用等)
  - 一 因天然災害或人意外造成之任何損壞(包括運輸及其他)
10. 如因產品故障而導致貴戶有任何直接或間接損失，本公司一概不負任何賠償責任。
11. 此保用只於香港特別行政區及澳門特別行政區通用。
12. 保用期後，用戶可就其擁有之日本山崎產品(註5)參加續保計劃，繼續享用本公司提供的保修服務。
13. 任何條款如有更改，本公司均不作另行通知。
14. 日本山崎保留一切爭議之最終決定權。

註1: 工商用途產品如無合約訂明，保用期一律為三個月(購買日期起計算)。

註2: 大型電器產品包括消毒碗櫃、嵌入式雙頭電磁爐、抽油煙機及電熱水爐及空調等，其他產品則屬小家電。

註3: 香港之上門維修只限港島、九龍及新界市區。東涌、馬灣、愉景灣、離島等偏遠地區則須額外收取交通費用。

註4: 個別產品的配件定義與範圍，請參閱網上說明。

註5: 參加續保計劃費用按產品而定，詳情可向維修部門查詢。本公司保留接納所有續保計劃申請之權利。

日本山崎電器(國際)有限公司

新界葵涌打磚坪街16-24號有利工業貨倉大廈11樓A室

電話：(852) 3563 6728

傳真：(852) 2401 2162

電郵：[csd@sanki.hk](mailto:csd@sanki.hk)

澳門哪吒廟街斜巷19號地下

電話：(853) 2876 7760

電郵：[csd@sanki.hk](mailto:csd@sanki.hk)

## Product Warranty Terms & Policy

Within 12 months(note 1) from the date of original purchase, Sanki will provide maintenance service on this product free of charge for Hong Kong and Macau customers. This warranty is subject to the following terms and conditions:

1. This warranty is not valid until Customer's registration information is returned to and received by our Service Centre within 10 days of purchase via one of the following methods:
  - Email the receipt and delivery note to [csd@sanki.hk](mailto:csd@sanki.hk).
2. Customer must present original purchase invoice at the time of service. We reserve the right to reject any service request if Customer fails to provide a valid proof of purchase.
3. Customer who fails to present original purchase invoice will be disqualified for free warranty.
4. The product must be used for its dedicated purposes under normal operations.
5. Sanki will, in its discretion within reason, repair or replace any defective part.
6. Sanki Electrical Appliance (international) Limited ("Sanki") will provide one year warranty service to product commencing from the day of purchase. During the warranty period, service fee may be charged for replacing parts.
7. During warranty period, large appliances(note 2) will receive free on-site service(note 3) by a Sanki-authorized technician. Other free-standing products should be brought or couriered to our Customer Service Centre for free maintenance service. Customer must be responsible for all related transportation costs.
8. Free warranty service will not be provided in circumstances listed below:
  - purchase invoice is modified by unauthorized party
  - product is repaired or modified by unauthorized party, or unauthorized parts are installed
  - serial number is modified, damaged or removed from the product ownership of product is transferred
  - warranty information is incorrect or not updated
9. Warranty service does not cover:
  - labour costs for on-site installation, check-up, repair, replacement of parts and other transportation costs incurred (except for on-site service on large appliances)
  - any accessory or peripheral not supplied with product (e.g. plastic or normal wear part, etc.)(note 4)
  - product failure caused by misuses (e.g. incorrect voltage, improper installation, operation not complied with user manual, negligence, etc.)
  - damages caused by accidents of any kind (including transport and others)
10. Sanki is not accountable for any direct or indirect loss incurred by the failure of product.
11. Warranty service is valid in Hong Kong SAR and Macau SAR only.
12. After warranty period, customer may continue to enjoy Sanki warranty service by joining our Warranty Renewal Scheme(note 5).
13. Warranty terms and conditions are subject to change without notice.
14. In case of any disputes, Sanki reserves all rights for final decision.

Note1: For products used in a commercial or industrial setting, unless stated otherwise in a legal contract, warranty period is limited to 3 months only (starting from the date of purchase).

Note2: "Large Appliances" include Dish Sterilizer, Built-In Induction Cooker (Double-Burner), Range Hood, Water Heater & Air-Conditioner etc. The other products would be considered as "Free-standing Appliances".

Note3: For Hong Kong customers, free on-site service is available in Hong Kong, Kowloon & New Territories only. Extra charges may be applied to locations in Tung Chung, Ma Wan, Discovery Bay, outlying islands and remote areas.

Note4: For definition and details of accessories and peripherals of each product, please refer to online checklist.

Note5: The cost of Warranty Renewal Scheme depends on the different products, please contact us via email to confirm the details. Sanki reserves the right of acceptance for the application of Warranty Renewal Scheme.

Sanki Electrical Appliance (International) Limited

Flat A, 11/F, Mercantile Industrial And Warehouse Building,  
16-24 Ta Chuen Ping Street, Kwai Chung, N.T.

Tel: ( 852 ) 3563 6728

Fax: ( 852 ) 2401 2162

E-Mail: [csd@sanki.hk](mailto:csd@sanki.hk)

No.19 Calçada das Verdades, Macau

Tel:( 853 ) 2876 7760

E-mail: [csd@sanki.hk](mailto:csd@sanki.hk)