

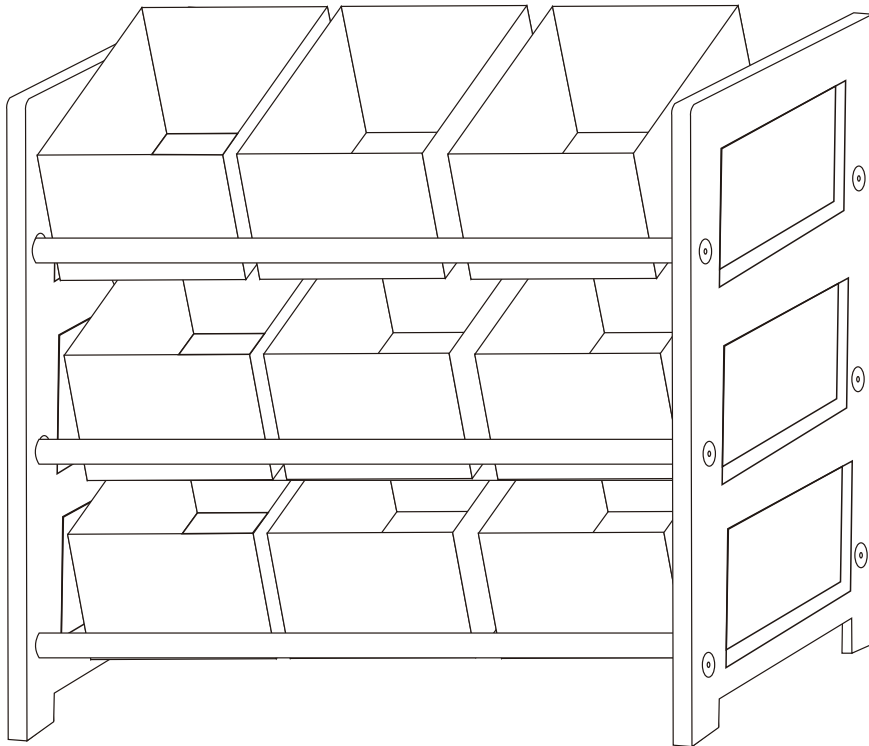

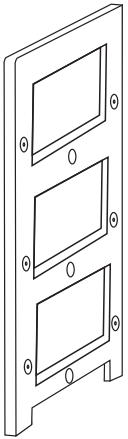

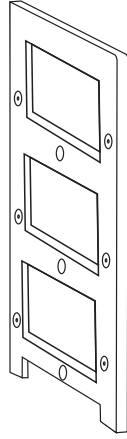



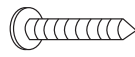

MOBEL 9 BIN STORAGE 九格儲物檯
ITEM CODE (產品編號) : 355302
ASSEMBLY INSTRUCTION 組裝說明書

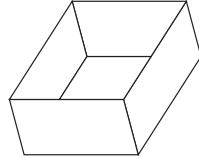
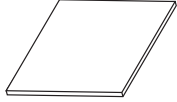

PARTLIST 配件

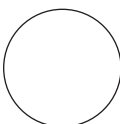
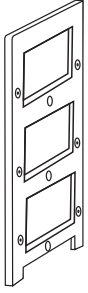
A	B	C	a	b
				
1pc	1pc	6pcs	12pcs	12pcs
		D	E	F
				
		3pcs	9pcs	9pcs

1
a

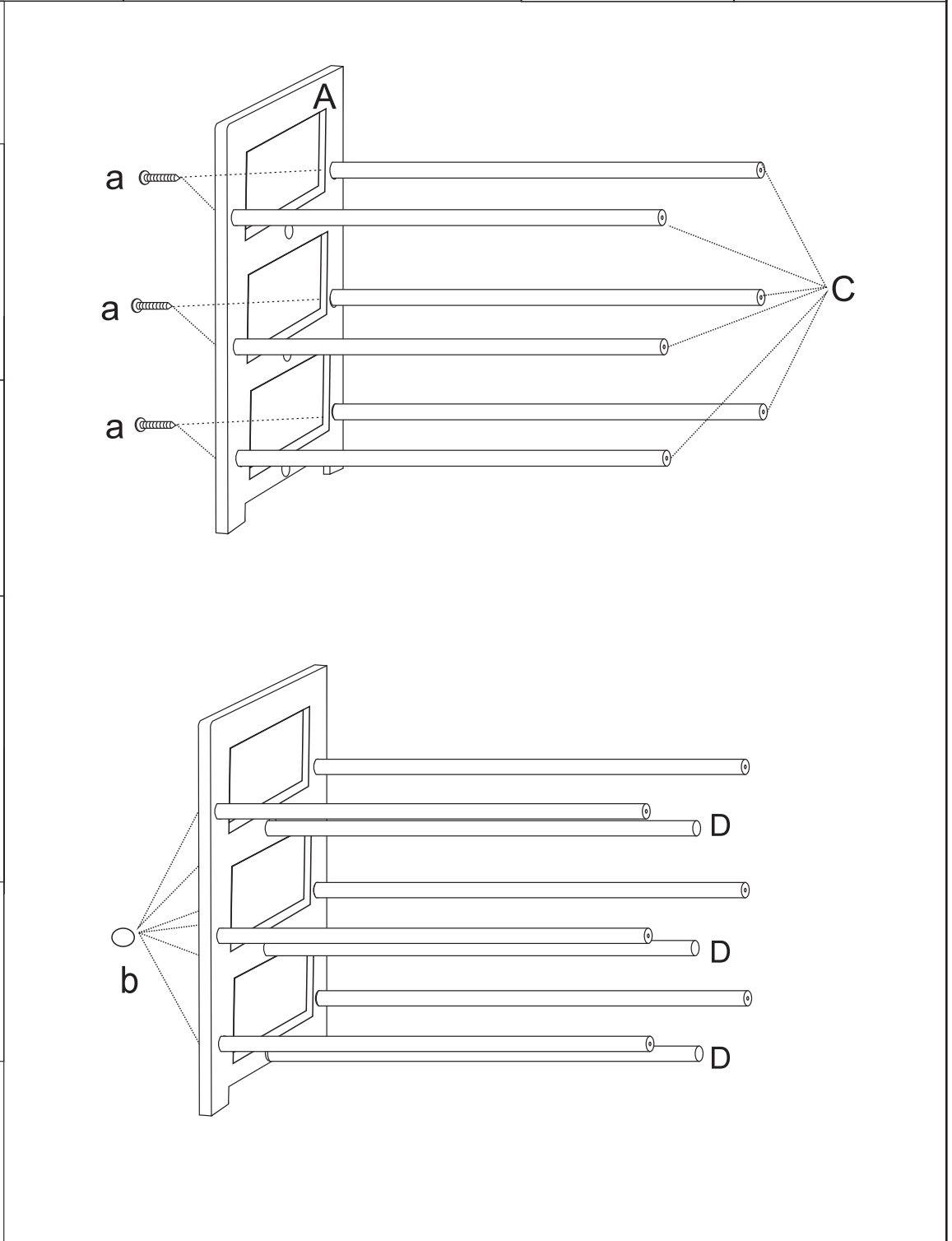
6pcs
b

6pcs
A

1pc
C

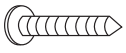
6pcs
D

3pcs



2

a



6pcs

B

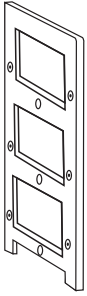

1pc

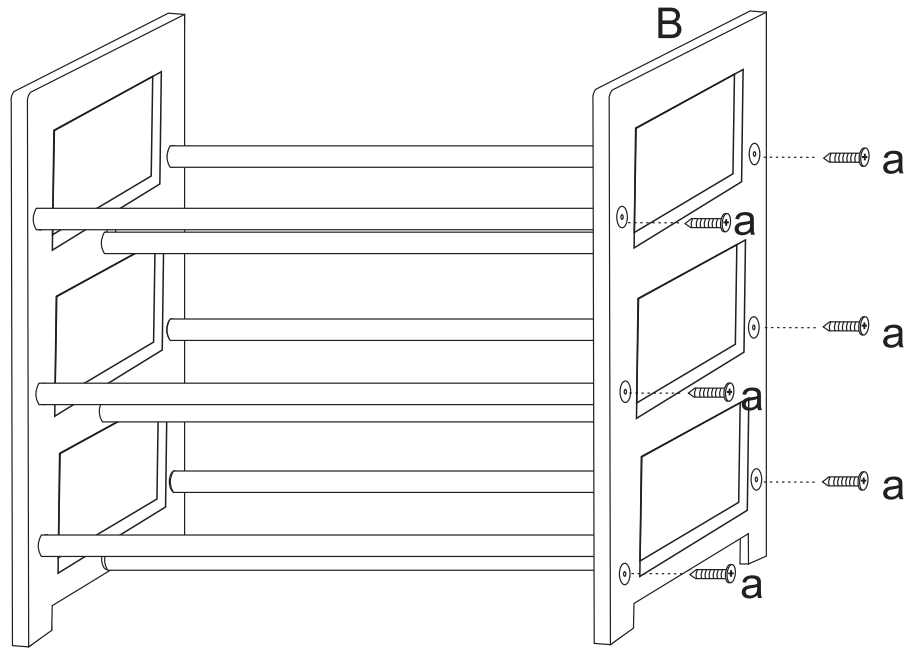

3

E

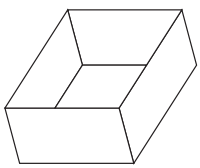

9pcs

F

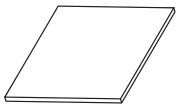

9pcs

b

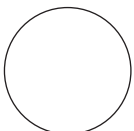

6pcs

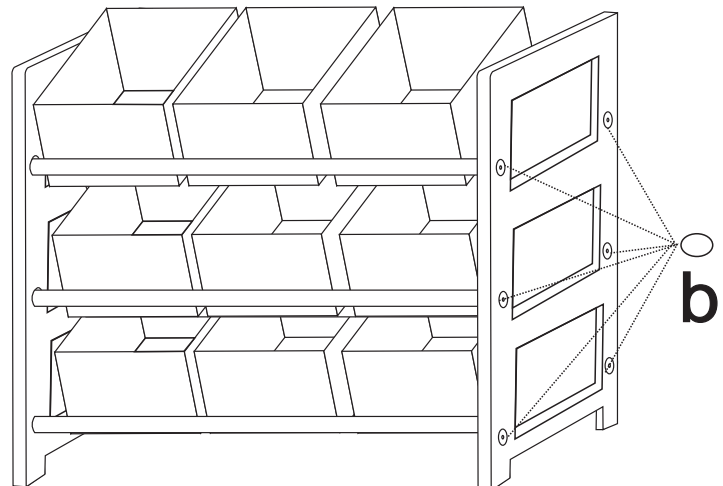
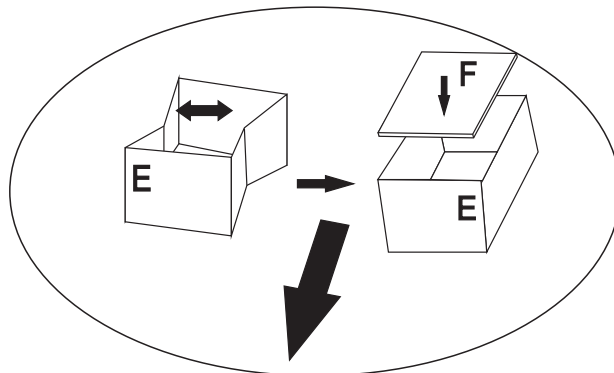

WARNING! DANGER TO LIFE AND RISK OF ACCIDENT FOR INFANTS AND CHILDREN!

警告！ 嬰兒和兒童的生命構成危險和風險！

Never leave children unsupervised contact with the packaging material. There is a danger of suffocation.
切勿讓兒童在未監督的情況下與包裝材料接觸。會有窒息的危險。

During installation, keep children away from the area in which you are working.
The contents of this package include many small screws and small parts.
These small parts could be inhaled or swallowed and cause a danger to life.
在安裝過程中，請讓孩子們遠離您工作的地方。
該包裝的物品中包括許多小螺釘和小零件。這些小零件可能被吸入或吞嚥並危及生命。

Cautions 注意事項

Make sure all parts are present before starting the assembly of your furniture.
開始組裝家具之前，請確保所有零件都存在。

One / Two people are required to assemble this item.
需要一/兩人組裝該物品。

For larger items, make sure you have enough space to safely assemble your product.
對於較大的物品，請確保您有足夠的空間安全地組裝產品。

For better protection of your furniture, we recommend placing your product on a protected surface during assembly to prevent damage.

為了更好地保護您的家具，我們建議您在組裝家具過程中，將家具放在平整的表面上以防止損壞。

During assembly, please take care not to over-tighten the fasteners as this may damage the product.
在組裝過程中，請注意不要過度擰緊緊固件，因為這可能會損壞產品。

Assemble this product on a flat, solid and even surface.
將本產品組裝在平坦，牢固且平坦的表面上。

Do not stand on the product. Do not use the product as a stepladder.
請勿站在本產品上。請勿將本產品用作梯子。

Do not lift or move the product if it is supporting any object. 當產品在負載東西時，請勿抬起或移動產品。

This product is intended for domestic and indoor use only. 本產品僅供家庭和室內使用。

The item is not a toy or a climbing apparatus. Ensure all people especially children, do not climb up on the item or lean against it. The item may fall over.
該物品不是玩具或攀爬設備。確保所有人尤其是兒童，不要爬上或倚靠在物品上。該項目可能會掉下來。

Do not knee on any part of the product during assembly.
在組裝過程中，請勿跪在產品的任何部位。

Do not load the product with a weight of more than 15 kg, otherwise there is a risk of injury and / or damage to the product. 請勿將重量超過 15 公斤的產品裝入本產品中，否則有造成人身傷害和/或損壞產品的危險。

Maximum load: 5 kg per layer.

最大負載：每層 5 公斤。

Care and Maintenance Recommendation for your furniture.

家具保養和保養建議

Check the bindings from time to time and tighten them if necessary.

不時檢查裝訂線，必要時將其擰緊。

When not in use, always store the product clean and dry at room temperature. Only clean the product with a damp cloth and wipe dry afterwards.

在不使用時，請在室溫及清潔乾燥的環境下存放產品。僅用濕布清潔產品，然後擦乾。
請勿使用研磨劑，溶劑和漂白劑清潔產品。

Do not drag or pull your furniture.

請勿拖動或拉動家具。

After use the product for a period of time, please check on the product every time before use.

使用產品一段時間後，請在使用前每次檢查產品。

The English version of the above shall prevail whenever there is a discrepancy between the English and Chinese versions.

以上內容的中英文文本如有歧異，概以英文文本為準。

Please retain the instruction manual for future reference.

請保留說明書以備將來參考。

產品由【置好價】出售

Manufactured for and distributed by 「置好價」 Spot On Dealz

Website: www.spotondealz.com.hk

Telephone: (852) 2117 1881

Made in China 中國製造