

## Wall-mounted Type ESS Battery

TW-WM51200-HWB TW-WM48200-HWB  
TW-WM51100-HWB TW-WM48150-HWB  
TW-WM51150-HWB TW-WM48100-HWB

### Feature

- \* Using lithium iron phosphate core technology, high safety, 80% DOD charging and discharging under standard conditions, more than 6000 cycles.
- \* High integrated analog front end, isolated power circuit.
- \* Integrated serial port IC, high voltage accuracy ( $\leq 20\text{mV}$ ), high current accuracy ( $\pm 2\% @ \text{FS}$ )
- \* 4-way battery temperature detection ( $\leq 2^\circ\text{C}$ ), SOC estimation function, SOH estimation function.
- \* Short circuit protection function, adjustable overcurrent protection, multiple sleep and wake-up modes, low power consumption.
- \* Dual RS485 communication, parameter adjustable setting, buzzer alarm function, LED status indication function, charging equalization function.
- \* Temperature range of battery:  $-20\text{--}60^\circ\text{C}$ .
- \* Support parallel (up to 15 groups) application expansion.

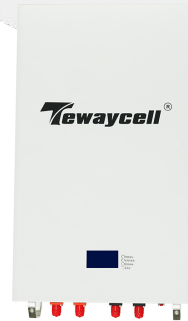

### Application

Standby power supply and household energy storage.  
Solar and wind energy systems.



## Catalogue

1	Safety tips .....	2
1.1	Preface .....	2
1.2	Safety disclaimer .....	2
1.3	Description of safety matters .....	2
2	Product description .....	3
2.1	Product dimension .....	3
2.2	Product details .....	4
2.3	Electrical schematic diagram .....	5
3	Technical specifications .....	5
4	BMS characteristics.....	7
4.1	Instructions for LED lights .....	7
4.1.1	SOC capacity indicator.....	7
4.1.2	Status indicator.....	8
4.2	Boot and sleep mode .....	9
4.3	Communication area .....	9
5	Description of parallel connection.....	11
5.1	Parallel Connection Diagram.....	11
5.2	Communication line parallel diagram.....	11
5	Operating instructions .....	13
5.1	Operating instructions of the display screen .....	13
5.1.1	Introduction of LCD Display .....	13
5.1.2	Boot screen .....	13
6	Product list and tools .....	18
6.1	Product packing lists .....	18
6.2	Prepared tools and instruments .....	19
7	Instruction manual .....	20
8	Application.....	23

Add: Building A, Xinida Industrial Park, Junzibu Village, Guanlan Stree, Longhua District , Shenzhen, Guangdong  
TEL :0755-23225527

FAX:0755-23225537



# 1 Safety tips

## 1.1 Preface

Thanks for choosing Topway New Energy power wall battery. In order to make you better use and maintain this product, please read the user manual carefully before use.

The features of this product are as follows:

1. Adopt brand new lithium iron phosphate cell; Higher security; In the standard state, 80% DOD charge-discharge  $\geq 6000$  times cycle;
2. Highly integrated analog front end; Isolating power supply circuit;
3. Integrated serial port IC, high voltage accuracy ( $\leq 20\text{mV}$ ), high current accuracy ( $\leq 2\% @ \text{FS}$ );
4. Four-channel battery temperature detection ( $\leq 2^\circ\text{C}$ ), SOC estimation function, SOH estimation function;
5. Short-circuit protection function, adjustable overcurrent protection, a variety of sleep and wake up mode, low power consumption;
6. Dual-port RS485 communication, parameter adjustable setting, buzzer alarm function, LED status indicator function, with charge balance power;
7. Wide temperature range:  $-20^\circ\text{C} \sim 60^\circ\text{C}$  ;
8. Parallel connection (up to 15 groups) application expansion is supported, but serial connection is not recommended.

## 1.2 Safety disclaimer

When installing, using and maintaining this product, users must read this chapter carefully and follow the safety precautions required in this chapter. Any injuries and losses caused by illegal operation are not related to our company.

➤ **NOTE:** It is strictly forbidden to dismantle the case if

**Non-professionals, and no warranty service will be provided after.**

## 1.3 Description of safety matters

1. Keep the battery out of the reach of children and babies;
2. Do not put the battery in the oven or other similar equipment;
3. Do not remove the product label;
4. Do not try to open the battery pack;

Add: Building A, Xinida Industrial Park, Junzibu Village, Guanlan Stree, Longhua District ,Shenzhen, Guangdong  
TEL :0755-23225527

FAX:0755-23225537

5. Do not be exposed to the environment above 60°C(300F);
6. Do not short-circuit the positive and negative terminals of the battery with wires or other metal objects. Do not transport or store batteries with metal objects;
7. Do not expose the battery to direct heat or flame. Do not use or store batteries near fire or high temperature;
8. Do not immerse the battery in water, salt water or any other liquid or make it wet;
9. Do not pierce the battery with any sharp object, knock it with a hammer or similar device, step on it, fall it or get strong vibration;
10. Do not use the battery if it is damaged or deformed;
11. If the battery produces odor, smoke or abnormal heat, please stop using it immediately;
12. If the battery liquid leaks and comes into contact with your eyes, please don't rub your eyes, and immediately rinse them with plenty of water before seeking medical assistance.

## 2 Product description

### 2.1 Product dimension

Model	Size(L*W*H)
TW-WM-51200- 100A- HWB	742*420*235mm
TW-WM-48200- 100A- HWB	
TW-WM-51150- 100A- HWB	
TW-WM-48150- 100A- HWB	
TW-WM51100- 100A- HWB	642*400*185mm
TW-WM48100- 100A- HWB	

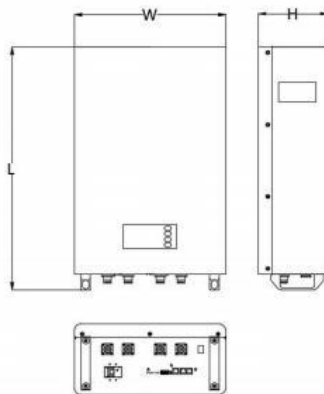

Add: Building A, Xinida Industrial Park, Junzibu Village, Guanlan Stree, Longhua District ,Shenzhen, Guangdong  
 TEL :0755-23225527

FAX:0755-23225537

## 2.2 Product details

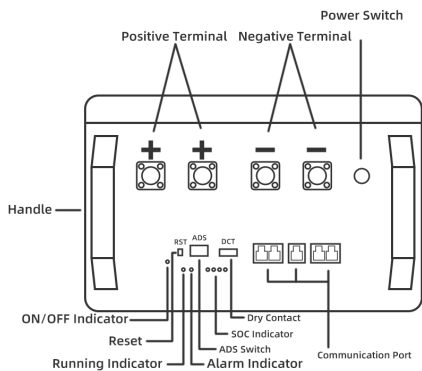
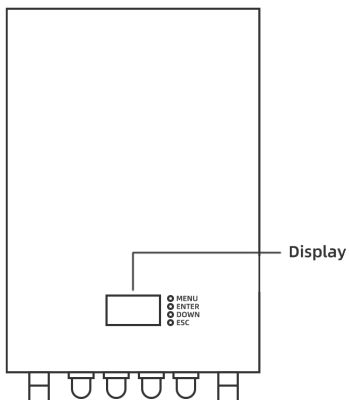

Add: Building A, Xinida Industrial Park, Junzibu Village, Guanlan Stree, Longhua District ,Shenzhen, Guangdong  
 TEL :0755-23225527

FAX:0755-23225537

## 2.3 Electrical schematic diagram

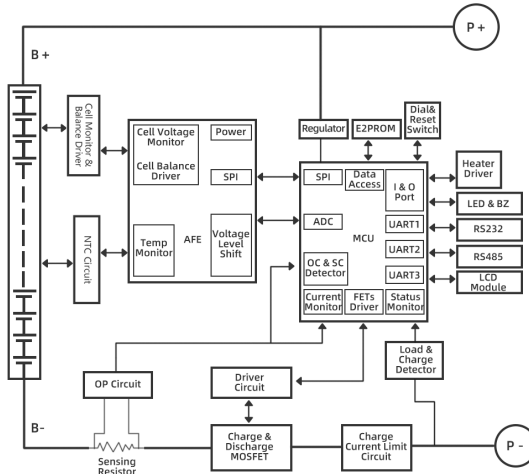

## 3 Technical specifications

Table 1 Technical specification table

No.	Project	Specifications					
1	Model	TW- WM 51200- 100A - HWB	TW- WM 51150- 100A - HWB	TW- WM 51100- 100A - HWB	TW- WM 48200- 100A - HWB	TW- WM 48150- 100A - HWB	TW- WM 48100- 100A - HWB
2	Nominal capacity	200Ah@ 0.2C	150Ah@ 0.2C	100Ah@ 0.2C	200Ah@ 0.2C	150Ah@ 0.2C	100Ah@ 0.2C
3	Nominal voltage	51.2V			48.0V		
4	Charging voltage	56.8-57.6V			53.2-54.0V		

Add: Building A, Xinida Industrial Park, Junzibu Village, Guanlan Stree, Longhua District ,Shenzhen, Guangdong  
TEL :0755-23225527

FAX:0755-23225537



5	Operating voltage	43.2V~58.4V			40.5V~54.75V		
6	Charging standard current	40A	30A	20A	40A	30A	20A
	Fast charging current	80A					
7	Standard charging mode	At a temperature of 25°C, charge to 58.4V with a constant current of 0.2C, and then change continuously with a constant voltage of 58.4V until the current is not greater than 0.02C.			At a temperature of 25°C, charge to 54.75V with a constant current of 0.2C, and then change continuously with a constant voltage of 54.75V until the current is not greater than 0.02C.		
8	Maximum charging current	100A					
9	Maximum discharge current	100A					
10	Charging temperature	0°C to 45°C (32°F to 113°F) @60± 25% relative humidity					
11	Discharge temperature	-20°C to 60°C (-4°F to 140°F) @60± 25% relative humidity					
12	Storage temperature	-20°C to 60°C (-4°F to 140°F) @60± 25% relative humidity					
13	Line joint	120A Self- Locking Fitting Quick Release Connector					
14	Net Weight Approx	86kg	70kg	51kg	82kg	67kg	49kg
15	Communication protocol	RS485 、 RS232 、 CAN					
16	Support inverter brand	Growatt 、 Deye 、 Goodwe 、 Voltronic 、 Sofar 、 VICTRON 、 Megarevo 、 SRNE 、 PYLON 、 Luxpowertek 、 Sorotec 、 SMA 、 GINLONG 、 MUST 、 TBB 、 STUDER					

Add: Building A, Xinida Industrial Park, Junzibu Village, Guanlan Stree, Longhua District ,Shenzhen, Guangdong  
 TEL :0755-23225527 FAX:0755-23225537

# 4 BMS characteristics

## 4.1 Instructions for LED lights

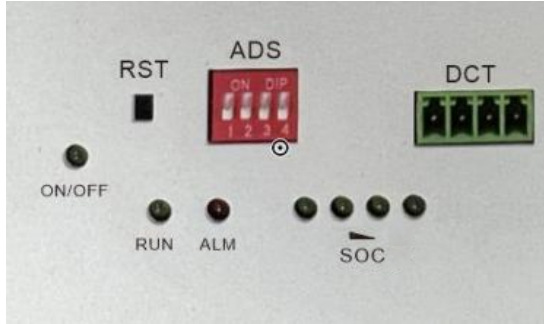

Picture 3 Battery indicator lamp

Four green capacity indicators, a red alarm indicator, a green running indicator and a switch indicator.

### 4.1.1 SOC capacity indicator

Table 2 SOC indicator status table

Condition		Charge				Discharge			
Capacity indicator lamp		L1	L2	L3	L4	L1	L2	L3	L4
power (%)	0~25%	Flash 2	OFF	OFF	OFF	ON	OFF	OFF	OFF
	25~50%	ON	Flash 2	OFF	OFF	ON	ON	OFF	OFF
	50~75%	ON	ON	Flash 2	OFF	ON	ON	ON	OFF
	75~100~	ON	ON	ON	Flash 2	ON	ON	ON	ON
Running indicator light		ON				Flash 3			



## 4.1.2 Status indicator

Table 3 Status indicator status table

Status	Warning/Normal/ Protection	ON/ OFF	Run	Alert	LED Battery Level Indicator				explain
		•	•	•	•	•	•	•	
Shut down	Sleep mode	ON	OFF	OFF	OFF	OFF	OFF	OFF	Light off
Standby	normal	ON	Flash 1	OFF	According to the electricity indication				standby mode
	warning	ON	Flash 1	Flash 3					Module low voltage
charge	normal	ON	ON	OFF	According to the power indicator ( the maximum LED of the power indicator flashes 2)				The maximum power LED flashes (flash 2),and the ALM does not flash during the overshoot.
	warning	ON	ON	Flash 3					
	Overcharge Protection	ON	ON	OFF	ON	ON	ON	ON	If there is no mains supply, the indicator turns to standby
	Temperature, over current, failure, protection	ON	OFF	ON	OFF	OFF	OFF	OFF	stop charging
discharge	normal	ON	Flash 3	OFF	According to the electricity indication				
	warning	ON	Flash 3	Flash 3					
	UVLO	ON	OFF	OFF	OFF	OFF	OFF	OFF	Stop discharge
	Temperature, over current, short out, reversed polarity ,FAIL-SAFE	ON	OFF	ON	OFF	OFF	OFF	OFF	Stop discharge
Invalid		OFF	OFF	ON	OFF	OFF	OFF	OFF	Stop charging and discharging

Table 4 LED flashing description

Flashing mode	ON	OFF
Flash 1	0.25s	3.75s
Flash 2	0.5s	0.5S
Flash 3	0.5s	1.5s

## 4.2 Boot and sleep mode

Sleep mode: the battery will be in sleep mode if any of the following conditions are met

1) The battery or battery pack over discharge protection lasts for 30 seconds and is not released.

2) Press the power on / off button for 3 seconds and release.

3) The minimum voltage of the battery is lower than the "sleep voltage" setting in the setting, without charging and discharging.

4) Standby for more than 24 hours without charging and discharging.

5) Switch to the upper computer for sleep manually.

Wake up: the battery will exit sleep mode if any of the following conditions are met

1) Charger is plugged in;The charger voltage is greater than 48V.

2) Press the power on / off button for 3 seconds and release.

3) Plug in the communication cable and open the upper computer software (not available if it is under over discharge protection).

Note: if over discharge protection is enabled, the battery will be in sleep mode. The battery will wake up automatically every 4 hours and turn on the charge / discharge MOS. If charging is available, the battery will be charged, otherwise it will return to sleep mode. If it has been awakened 10 times but cannot be charged, the battery will not wake up again automatically.

## 4.3 Communication area



Picture 4 Communication interface diagram

1. RS232: BMS can communicate with upper computer through RS232 interface, so as to monitor various information of battery, including battery voltage, current, temperature, status and battery production information, etc. the default baud rate is 9600bps.
2. RS485: with dual RS485 interface, you can view the information of pack. The default baud rate is 9600bps. If it is necessary to communicate with the monitoring equipment

Add: Building A, Xinida Industrial Park, Junzibu Village, Guanlan Stree, Longhua District , Shenzhen, Guangdong

TEL :0755-23225527

FAX:0755-23225537

through RS485, the monitoring equipment is used as the host, polling data according to the address, and the address setting range is 1 ~ 15.

3. CAN: CAN communication, baud rate 9600bps.
4. RS485 and CAN: The user can communicate with the inverter through these two interfaces.
5. RS485 add RS232: The users can connect to the computer through these two interfaces.
6. DCT: Dry contact interface.
7. Rst: reset button.
8. ADS: dial switch

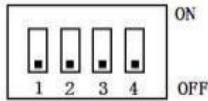

### 9. Interface diagram

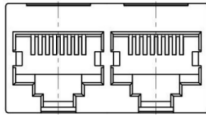

CAN and RS485 interface



Dry contact

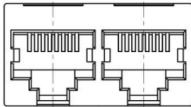

Parallel communication port

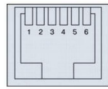

RS232 communication interface

### 10. Definition of electrical interface

RS232 -- 6P6C vertical RJ11 plug	
RJ11 pin	Definition Description
2	NC
3	TX(Single board)
4	RX(Single board)
5	GND

Table 1RS485 and CAN Interface

RS485 - 8P8C vertical RJ45 socket		CAN - 8P8C vertical RJ45 socket	
RJ45 pin	Definition Description	RJ45 pin	Definition Description
1、8	RS485- B1	9、10、11、14、16	NC
2、7	RS485-A1	12	CANL
3、6	GND	13	CANH
4、5	NC	15	GND

Add: Building A, Xinida Industrial Park, Junzibu Village, Guanlan Stree, Longhua District ,Shenzhen, Guangdong

TEL :0755-23225527

FAX:0755-23225537

Table 2 Parallel communication port

RS485 - 8P8C vertical RJ45 socket		RS485 - 8P8C vertical RJ45 socket	
RJ45 pin	Definition Description	RJ45 pin	Definition Description
1、8	RS485- B	9、16	RS485- B
2、7	RS485-A	10、15	RS485-A
3、6	GND	11、14	GND
4、5	NC	12、13	NC

## 5 Description of parallel connection

### 5.1 Parallel Connection Diagram

If parallel batteries are required, connect the wires according to the diagram , maximum support for 15 batteries in parallel



Picture 2 Parallel connection diagram

### 5.2 Communication line parallel diagram

The signal line connected to the inverter should use RS485 communication line or CAN communication line. If it is necessary to use batteries in parallel :

Add: Building A, Xinida Industrial Park, Junzibu Village, Guanlan Stree, Longhua District ,Shenzhen, Guangdong  
 TEL :0755-23225527 FAX:0755-23225537

- ① RS485 cable shall be used to connect the parallel communication port. Refer to the communication line parallel diagram;
- ② The address of the battery needs to be set. Refer to the dial switch setting table for address setting,

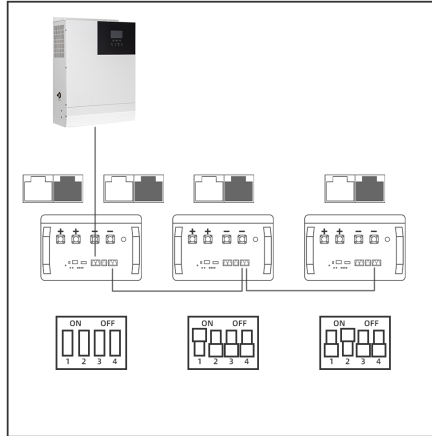

Figure 2 Communication line parallel diagram

Table 3 The Dial Switch Setting Table

Address	Dial switch position			
	#1	#2	#3	#4
0	OFF	OFF	OFF	OFF
1	ON	OFF	OFF	OFF
2	OFF	ON	OFF	OFF
3	ON	ON	ON	OFF
4	OFF	OFF	ON	OFF
5	ON	OFF	ON	OFF
6	OFF	ON	ON	OFF
7	ON	ON	ON	OFF
8	OFF	OFF	OFF	ON
9	ON	OFF	OFF	ON
10	OFF	ON	OFF	ON
11	ON	ON	OFF	ON
12	OFF	OFF	ON	ON
13	ON	OFF	ON	ON
14	OFF	ON	ON	ON
15	ON	ON	ON	ON

Add: Building A, Xinida Industrial Park, Junzibu Village, Guanlan Stree, Longhua District ,Shenzhen, Guangdong

TEL :0755-23225527

FAX:0755-23225537

# 5 Operating instructions

## 5.1 Operating instructions of the display screen

### 5.1.1 Introduction of LCD Display



Button Description:

**MENU:** enter the management system.

**ENTER:** enter the submenu.

**DOWN:** moves the cursor down or to the next page.

**ESC:** returns to the previous one

### 5.1.2 Boot screen



Battery protection status:

Overvoltage: OV

Low voltage: LV

Overtemperature: OTt

Low temperature: IT

Over current: OC

Short circuit: SC

Note:when the battery is protected,the corresponding protection status will be displayed; otherwise,the protection status will not be displayed as the protection state.

1 Press "MENU" to enter the main menu

Note:">" indicates that there is a submenu. Press"enter" to enter the submenu



Analog Info	>>
BMS Status	>>
Para Setting	>>
Sys Setting	>>

Add: Building A, Xinida Industrial Park, Junzibu Village, Guanlan Stree, Longhua District , Shenzhen, Guangdong

TEL :0755-23225527

FAX:0755-23225537

2 Move the cursor to Analog info and press enter



Pack V	
Im	
Temperature	»
Cell Voltage	»
CellCapacity	»

Move the cursor to "temperature" and press "enter" to check the battery temperature information, then press "down" to turn the page



T1	XX°C
T2	XX°C
T3	XX°C
T4	XX°C
PCB-T	XX°C
ENV-T	XX°C

Move the cursor to "cell voltage" and press "enter" to check the battery voltage information, then press "down" to turn the page



Cell 01	xxxxmV
Cell 02	xxxxmV
Cell 03	xxxxmV
Cell 04	xxxxmV
Cell 05	xxxxmV
Cell 06	xxxxmV
Cell 07	xxxxmV
Cell 08	xxxxmV
Cell 09	xxxxmV
Cell 10	xxxxmV
Cell 11	xxxxmV
Cell 12	xxxxmV
Cell 13	xxxxmV
Cell 14	xxxxmV
Cell 15	xxxxmV

Move the cursor to "CellCapacity" and press Enter to check the battery capacity information

Add: Building A, Xinida Industrial Park, Junzibu Village, Guanlan Stree, Longhua District , Shenzhen, Guangdong

TEL :0755-23225527

FAX:0755-23225537

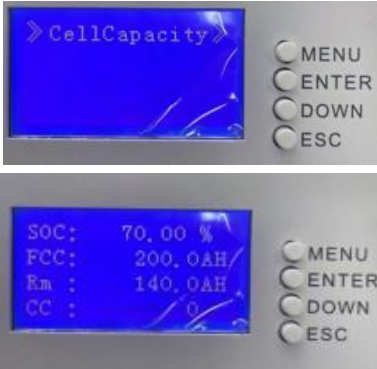

SOC	X%
FCC	XAH
Rm	XAH
CC	0

- 3 Move the cursor to “BMS Status”, press Enter to check the battery status, and press “▼” to turn the page



Status	
Record	»
BMS Status	»



Move the cursor to "Record", then press "Enter" to check the battery alarm information, then press "DOWN" to turn the page.



SCP	
0/UTP	
0CP	
UVP	
0VP	

Move the cursor to "BMS Status", then press "Enter" to check the battery protection information, and then press "DOWN" to turn the page.



UV	Y/N
UVP	Y/N
OC	Y/N
OT	Y/N
OTP	Y/N
OV	Y/N
OVP	Y/N
SCP	Y/N
Failure	Y/N

Move the cursor to "Para Setting" and press "Enter" to check the gyroscope information, then press "▼" to turn the page.

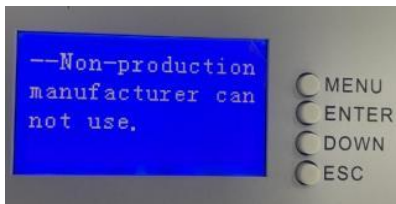

- 4 Move the cursor to "Sys Setting", then press Enter to check the version information, and then press "▼" to turn the page.

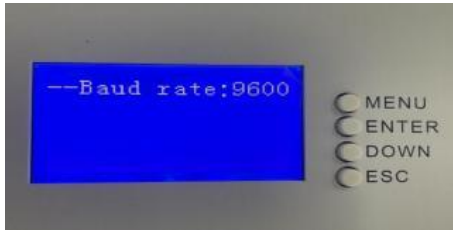





- 5 Hibernation and activation functions

After 1 minute of button-free operation in normal operation, the display will turn off (backlight only), and pressing any button while the screen is off will allow the screen to light up and function normally.





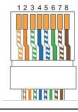







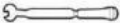

## 6 Product list and tools

### 6.1 Product packing lists

Home energy storage system series power supply has been strictly inspected before delivery, but may be damaged in transit, therefore, after unpacking the box, please check whether the following items are complete, confirm the model, capacity, input voltage and output voltage, and whether the specified content when ordering; If anything abnormal or inconsistent occurs, please contact the distributor as soon as possible.

	Picture			Description	Qty
Home energy storage battery					1 pieces
Product manual					1 pieces
Positive/ negative connector plug					Positive/ negative each one
Hexagon socket screw				screws that connect the battery to the protective plate	4 pieces
Signal line(Optional)	CAN	Connect inverter	RJ45		4-CAN- H 5-CAN- L
	RS485	Connect inverter	RJ45		1、 8- RS485- B 2、 7- RS485-A

## 6.2 Prepared tools and instruments

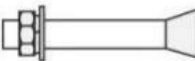
Type	Tools and instruments		
erecting tools			
			  
			
Personal protective tool			
			
Materials required for installation		Expansion screw (M8×50) 9pcs	

## 7 Instruction manual

1. Use hammer drill to drill 9  $\Phi 12$  through holes in the wall. The depth of each hole must be at least 60mm.

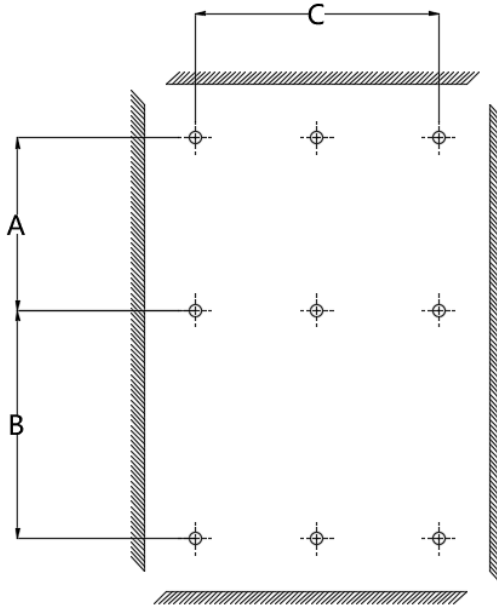

model	TW-WM51200-100A-HWB TW-WM48200-100A-HWB TW-WM51150-100A-HWB TW-WM48150-100A-HWB	TW-WM51100-100A-HWB TW-WM48100-100A-HWB
A(mm)	170	170
B(mm)	225	225
C(mm)	200	240

Add: Building A, Xinida Industrial Park, Junzibu Village, Guanlan Stree, Longhua District ,Shenzhen, Guangdong  
 TEL :0755-23225527

FAX:0755-23225537

2. Install the outer hanging plate on the wall and tighten it with 9pcs M8\*50 Expansion screw.

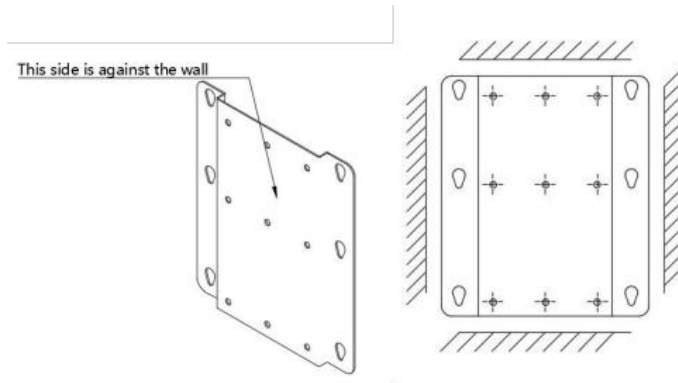

3. Hang 6pcs screws on the rear of the battery, attach the battery to the external mounting plate, and tighten the screws.

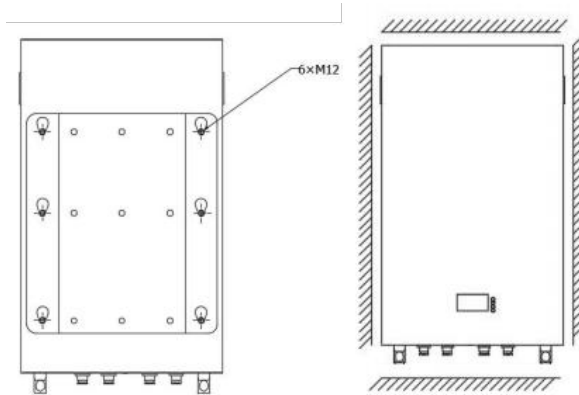

	TW-WM51200-100A-HWB	TW-WM51100-100A-HWB
	TW-WM48200-100A-HWB	TW-WM48100-100A-HWB
Screw	TW-WM51150-100A-HWB	
	TW-WM48150-100A-HWB	
	M12×20mm	M8×20mm

4. Plug the plug of the positive connector onto the positive pole of the battery, and then plug the plug of the negative connector onto the negative pole of the battery. The other end is connected to the inverter

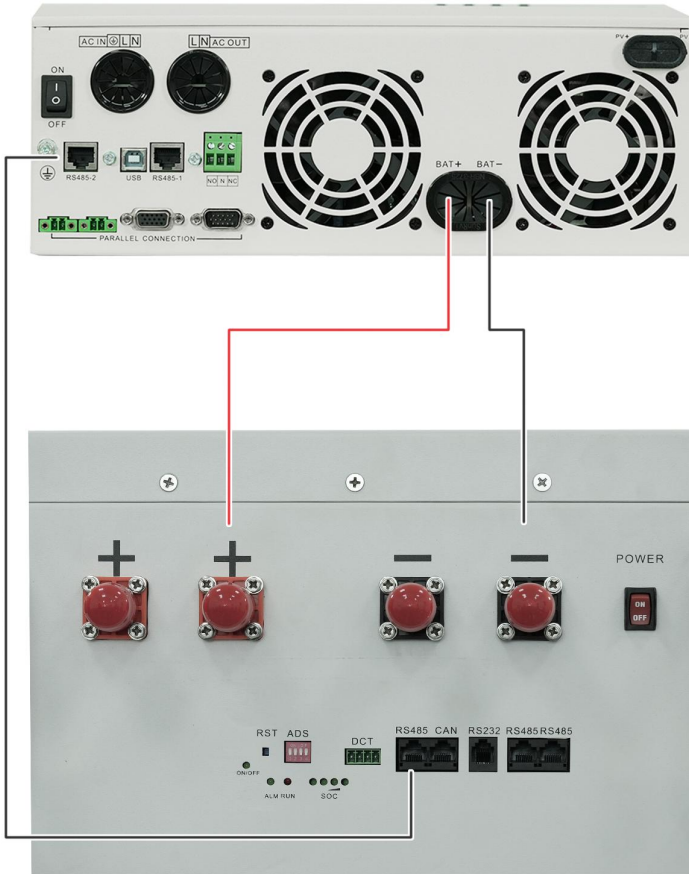

Add: Building A, Xinida Industrial Park, Junzibu Village, Guanlan Stree, Longhua District ,Shenzhen, Guangdong  
TEL :0755-23225527

FAX:0755-23225537

# 8 Application

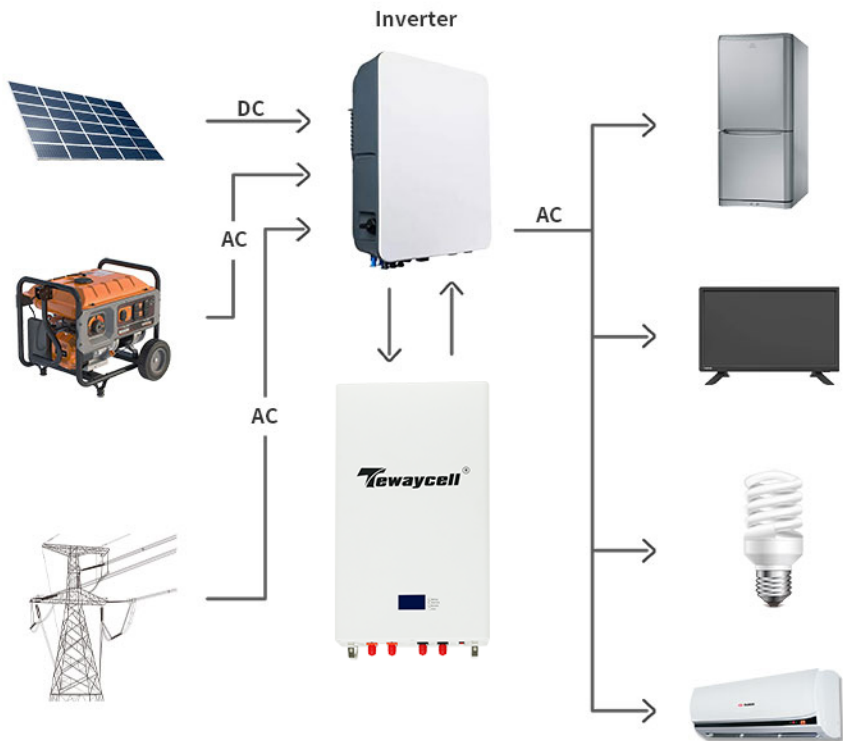

Add: Building A, Xinida Industrial Park, Junzibu Village, Guanlan Stree, Longhua District ,Shenzhen, Guangdong

TEL :0755-23225527

FAX:0755-23225537