

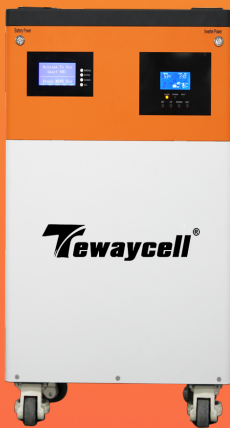

Mobile ESS Battery



AO-MB51100-5KW-EU

Suit for Solar and wind energy systems.

FEATURES

Long life and safety

Vertical industry integration ensures more than 6000 cycles with 80%DOD.

Easy to install and use

Integrated inverter design, easy to use and quick to install. Small size, minimizing installation time and cost compact and stylish design suitable for your sweet home environment.

Multiple working modes

The inverter has a variety of working modes. Whether it is used for main power supply in the area without electricity or backup power supply in the area with unstable power to deal with sudden power failure, the system can respond flexibly.

Fast and flexible charging

A variety of charging methods, which can be charged with photovoltaic or commercial power, or both at the same time.

Scalability

3 units can be paralleled for 3-phase output Maximum support for 6untilin parallel.

Contents

1	Instruction	7
1.1	Range of Application	7
1.2	Meaning of Abbreviations	7
1.3	Symbol Stipulations	8
2	Safety Precaution	8
2.1	Safety Symbols	8
2.2	General Safety	9
2.2.1	<i>Important Notice</i>	9
2.2.2	<i>General Requirements</i>	9
2.2.3	<i>Personnel Safety</i>	10
2.3	Personnel Requirements	10
2.4	Electrical Safety	11
2.4.1	<i>General Requirements</i>	11
2.4.2	<i>Grounding Requirements</i>	11
2.5	Installation Environment Requirements	12
3	Product Introduction	12
3.1	Brief Introduction to Product	12
3.2	System Specification	13
3.3	Model Coding	14
4	Description of All-in-one machine	14
4.1	Appearance Description	14
4.1.1	<i>Dimensions</i>	14
4.1.2	<i>Appearance description of all-in-one machine</i>	15
5	Application Scenarios	20
5.1	Application Scenarios	20
5.1.1	<i>Application Scenarios with Only Mains Power but No Photovoltaic</i>	20
5.1.2	<i>Application Scenarios with Only Photovoltaic but No Mains Power</i>	21
5.1.3	<i>Complete Application Scenarios</i>	21
6	Installation instructions for all-in-one machine	22
6.1	Inspections before Installation	22
6.1.1	<i>Inspection of outer package</i>	22
6.1.2	<i>Inspection of deliverables</i>	23
6.2	Selection of Installation Location	24
6.2.1	<i>Installation Space Requirements</i>	24
6.2.2	<i>Preparation of Tools and Meters</i>	24

7	Electrical Connection	24
7.1	Internal Electrical Connection of All-in-one machine	25
7.1.1	<i>Connecting Power Cord</i>	25
7.2	External Electrical Connection of All-in-one machine	25
7.2.1	<i>Wiring specifications and circuit breaker selection</i>	25
7.2.2	<i>Installation and wiring</i>	26
7.3	Installation and wiring	27
7.3.1	<i>Introduction</i>	27
7.3.2	<i>Precautions for connecting the parallel connecting lines</i>	28
7.3.3	<i>Schematic diagram of parallel connection in single phase</i>	29
7.4	Inspections before Power-On	36
7.5	Power-On of All-in-one machine	36
7.5.1	<i>Capacity Indicator</i>	37
7.6	Operating modes	38
7.6.1	<i>Charging mode</i>	38
7.6.2	<i>Output mode</i>	39
7.7	Inverter LCD Function Description	40
7.7.1	<i>Real-time data viewing method</i>	43
7.7.2	<i>Setup parameters description</i>	44
7.8	Battery LCD Function Description	49
8	System Maintenance	52
8.1	System Power-Off	52
8.2	Routine Maintenance	53
8.3	Trouble shooting	54
8.3.1	<i>Fault Code and Handling Methods</i>	54
8.3.2	<i>Common Faults and Handling Methods</i>	56
8.4	Battery Storage and Maintenance	56
8.4.1	<i>Battery Storage Requirements</i>	56
8.4.2	<i>Requirements for Charging of Battery</i>	57
8.5	Device Cleaning	57
9	Technical Data	58
10	Optional function	59
10.1	Active equilibrium module	59
11	Fire extinguishing function	59

1 Instruction

Thank you very much for choosing the TW-AO series household all-in-one machine system developed and produced by our company. Please read and understand all contents of the Manual carefully before installing and using the product. If you have any suggestions during the use, please do not hesitate to give us feedback.

NOTE: It is strictly forbidden to dismantle the case if Non-professionals, and no warranty service will be provided after.

1.1 Range of Application

The installation and user manual of TW-AO series is applicable to the installation and use of the following products:

No.	Applicable to the countries with 220V mains voltage
1	TW-AO-MB-51100-5KW-EU

The product should be used in compliance with local standards, laws and regulations, because any non-compliance with the use may lead to personal injuries and property loss.

The drawings provided in this Manual are used to explain the concepts related to the product, including product information, installation guide, electrical connection, system debugging, safety information, common problems and maintenance, etc.





The internal parameters of this product have been adjusted before delivery. No internal parameters can be changed without permission. Any unauthorized changes to the settings will invalidate the warranty, and the Company will not be liable for any loss resulting therefrom.

This Manual and other related documents are an integral part of the product and should be kept properly for onsite installation personnel and related technical personnel to consult.

1.2 Meaning of Abbreviations

AC	Alternating Current
DC	Direct Current
PV	Photovoltaic
BMS	Battery Management System
PCS	Power Conversion System
RJ45	Registered Jack 45
SOC	State Of Charge
C	Charge C-rate
RS485	RS485 Communication Interface
CAN	Controller Area Network









1.3 Symbol Stipulations

Symbol	Description
	Indicate a hazard with a high level of risk which, if not avoided, will result in death or serious injuries.
	Indicate a hazard with a medium level of risk which, if not avoided, could result in death or serious injuries.
	Indicate a hazard with a low level of risk which, if not avoided, could result in minor or moderate injuries.
	Warning information about device or environment safety. If not avoided, equipment damage, data loss, performance degradation or other unanticipated results may be resulted in. The "NOTICE" does not involve any personal injuries.

2 Safety Precaution

2.1 Safety Symbols

This product contains the following symbols, please pay attention to identifying.

Symbols	Description
	Observe enclosed documentation
	Danger. Risk of electric
	Danger of high voltages. Danger to life due to high voltages in the All-in-one machine system.
	Hot surface
	CE certification
	Do not touch the product in 5mins after shutdown
	Comply with RoHS Standard
	The All-in-one machine system should not be disposed together with the household waste.





2.2 General Safety



2.2.1 Important Notice

Before installing, operating and maintaining the device, please read this manual first and follow the symbols on the device and all the safety precautions in this manual. The matters indicated with "DANGER", "CAUTION", "ATTENTION" and "NOTICE" in this manual do not represent all the safety matters to be observed, but are only the supplements to all the safety precautions. The company will not be liable for any violation of general safety operating requirements, or any violation of safety standards for the design, production and use of the device. The device must be used in an environment that meets the requirements of the design specifications. Otherwise, the device may fail, and the abnormal device function or component damage, personal safety accident, and property loss arising from this are not covered within the quality assurance scope of the device. When installing, operating, and maintaining the device, the local laws, regulations, and codes shall be followed. The safety precautions in this manual are only supplements to local laws, regulations, and codes. The company shall not be liable for any of the following circumstances.

- The device is not run under the conditions of operating described in this manual.
- The installation and operating environment is beyond the requirements of relevant international or national standards.
- The product is disassembled or changed, or the software code is modified without authorization.
- The operation instructions and safety warnings related with the product and in the documents are not followed.
- Damage of the device is caused by abnormal natural environment (force majeure, such as earthquake, fire, and storm).
- Transportation damage is caused during customer's own transportation.
- The storage condition does not meet the requirements of the product related documents and causes damage.

2.2.2 General Requirements

	<p>Operating when the power is on is strictly prohibited during installation.</p>
	<p>It is strictly prohibited to install, use, and operate any outdoor equipment or cables (including but not limited to transporting equipment, operating equipment and cables, plugging and removing signal ports connected to the outdoor, working at altitude, and outdoor installation) in severe weather, such as thunder, rain, snow, and gale level 6.</p>
	<p>In case of any fire, evacuate the building or equipment area and press the fire alarm bell or dial the fire call. Under any circumstances, re-entry into a burning building is strictly prohibited.</p>
	<p>Under no circumstances should the structure and installation sequence of the device be changed without the manufacturer's permission.</p>
	<p>The battery terminal components shall not be affected during transportation. And, the battery terminal bolts shall not be lifted or transported.</p>

	<p>It is strictly prohibited to alter damage or block the marks and nameplates on the device.</p>
	<p>The composition and working principle of the entire photovoltaic power generation system, as well as the relevant standards of the country/region where the project is located shall be known fully.</p>
	<p>After the device is installed, the empty packing materials, such as cartons, foam, plastics, and cable ties, shall be removed from the device area.</p>

2.2.3 Personnel Safety

- When operating the device, appropriate personal protective equipment shall be worn. If any fault that may lead to personal injury or damage of the device is found, immediately terminate the operation, report to the responsible person, and take effective protective measures.
- Before using any tools, learn the correct method of using the tool to avoid injuries and damage of the device.
- When the device is running, the temperature of the case is high, which may cause burns. Therefore, do not touch the case.
- In order to ensure personal safety and normal use, reliable grounding should be carried out before use.
- Do not open or damage the battery. The electrolyte released is harmful to skin and eyes, so avoid touch it.
- Do not place irrelevant items on the top of the device or insert them into any part of the device.
- Do not place flammable items around the device.
- Never place the battery in the fire to avoid explosion and prevent the personal safety from being endangered.
- Do not place the battery module in water or other liquids.
- Do not short-circuit the battery terminals, because short-circuiting of the battery may cause combustion.

The battery may pose a risk of causing electric shocks and large short-circuit currents. When using the battery, the following precautions should be paid attention to:

- a) The metal objects, such as watch and rings, shall be removed.
 - b) Tools with insulated handles should be used.
 - c) Rubber gloves and shoes should be worn.
 - d) The charging power supply shall be disconnected before connecting or disconnecting terminals of the battery.
 - e) Check whether the battery is accidentally grounded. If the battery is accidentally grounded, remove the power supply from the ground.
- Do not clean the internal and external electrical components of the cabinet with water or detergent.
 - Do not stand, lean or sit on the device.
 - Do not damage any modules of the device.

2.3 Personnel Requirements

- The personnel in charge of installation and maintenance must be strictly trained to understand all safety precautions and master proper operation methods.
- Only qualified professionals or trained personnel are allowed to install, operate and maintain the device.
- The personnel who operate the device, including the operators, trained personnel and professionals, must have special operation qualifications required by the local country, such as

Add: Building A, Xinlida Industrial Park, Junzibu Village, Guanlan Street, Longhua District, Shenzhen, Guangdong

TEL :0755-23225527 FAX:0755-23225537

high voltage operation, working high above the ground, and special equipment operation qualification.

- The replacement of device or components (including software) must be carried out by professionals or authorized personnel.

2.4 Electrical Safety

2.4.1 General Requirements



Before carrying out electrical connections, ensure that the device is not damaged, or an electric shock or fire may occur.



Never install or remove any power cables when the power is on. The electric arcs or sparks may be generated at the moment when the power cable contacts with the conductor, which may cause fire or personal injuries.

- All the electrical connections must meet the electrical standards of the country/region where the project is located.
- The cables prepared by users themselves shall comply with local laws and regulations.
- Special insulating tools should be used in high-voltage operations.
- Before connecting the power cord, ensure that the label identification on the power cord is correct.
- Operations on the device are allowed only five minutes after the device is completely powered off.
- The insulation layer of the cable may be aged or damaged when the cable is used in a high temperature environment. Therefore, the distance between the cable and the heat source must be at least 30mm.
- Cables of the same type should be bundled together. Whereas, the cables of different types should be routed at least 30mm apart, and shall not be wrapped together or crossed.

2.4.2 Grounding Requirements

- When installing the device to be grounded, the protective grounding wire must be installed first; when removing the device, the protective grounding wire must be removed at last.
- It is forbidden to destroy the grounding conductor.
- It is forbidden to operate the device without a grounding conductor installed.
- The device shall be permanently connected to the protective grounding wire. Before operating the device, electrical connection of the device shall be checked to ensure that the device is reliably grounded.

2.5 Installation Environment Requirements

- Do not install or use this product in an environment where the temperature is lower than -10 °C or higher than 50 °C.
- It should be installed in a dry and well-ventilated environment to ensure good heat dissipation performance.
- The product can be installed at a maximum altitude of 2,000m.
- The installation position should be away from the fire source.
- The product should be installed and used away from children and animals.
- The installation position should be far away from water sources, such as faucets, sewer pipes, and sprinklers, to avoid entering of water.
- The device should be placed on a firm and flat supporting surface.
- Do not place any inflammable or explosive items around the device.
- When the device is running, do not block the ventilation vent or heat dissipation system to prevent fire caused by high temperature.



The operation and service life of the all-in-one machine is related to the operating temperature. The all-in-one machine should be installed at a temperature equal to or better than the ambient temperature.

3 Product Introduction

3.1 Brief Introduction to Product

TW-AO is a new generation of household all-in-one machine system with two output specifications of 110V, which can meet the diversified needs of global users.

The brand new topological circuit design is adopted in the power module, which can realize the energy exchange between photovoltaic, mains, battery and loads, and has the function of photovoltaic and mains charging. The photovoltaic charging module adopts the latest optimized MPPT tracking technology, which can quickly track the maximum power point of the photovoltaic array in any environment, and obtain the maximum energy of the solar panel in real time. In addition, MPPT has a wide voltage range. The advanced control algorithm is adopted in the mains charging module to realize the fully-digital double closed-loop control of voltage and current, so the control precision is high and the volume is small. The AC voltage input range is wide, and the input/output protection functions are complete, which can realize the stable and reliable charging and protection of batteries. The inverter module is based on the full-digital intelligent design, adopts the advanced SPWM technology, outputs pure sine wave, converts direct current into alternating current, and is applicable for household appliances, power tools and other AC loads.

The typical topological diagram for application of the system is as follows:

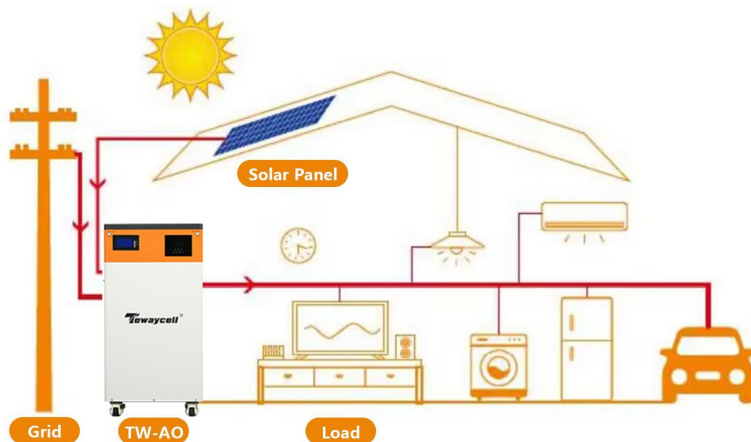

3.2 System Specification

Product mode	Battery Energy	Rated Output Power	Rated Output Voltage (Vac)	Frequency	Charge Current	Max. PV Power
TW-AO-MB51100-5KW-EU	5.12kWh	5000W	230Vac	50Hz	0~100A	4500W

3.3 Model Coding

The model coding of the all-in-one machine battery is as follows:

TW-AO-MB-51100-5KW-EU

① ② ③ ④ ⑤ ⑥

Identifier	Meaning	Value
①	Model	All-in-one
②	Product type	Roller type
③	Battery voltage	51.2V rated voltage
④	Battery capacity	100AH rated capacity
⑤	Inverter power	5KW rated power
⑥	Plug Specification	Europe

4 Description of All-in-one machine

4.1 Appearance Description

4.1.1 Dimensions

Model	Dimensions (L*W*H)
TW-AO-MB-51110-5KW-EU	660.0*450.0*300.0

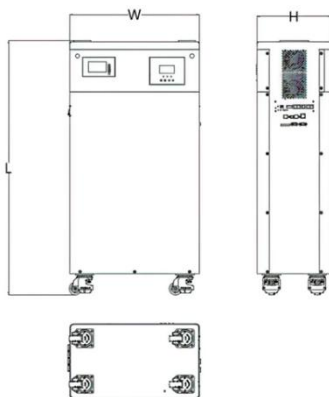

4.1.2 Appearance description of all-in-one machine

Inverter communication interface

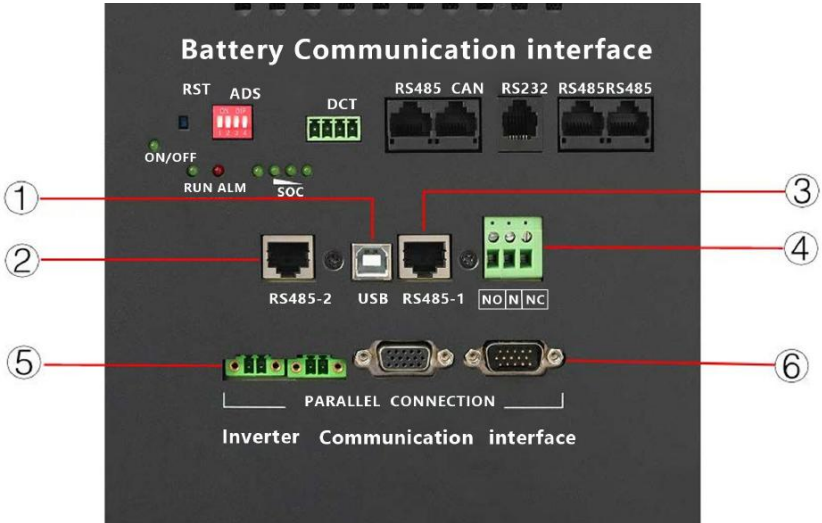

① USB	② RS485-2	③ RS485-1	④ Dry contact
⑤ Current sharing detection		⑥ Parallel communication	

Dry node:

Working principle: This dry node can control the ON/OFF of the diesel generator to charge the battery.

① Normally, the terminals are that the NC-N point is closed and the NO-N point is open;

② When the battery voltage reaches the low voltage disconnection point, the relay coil is energized, and the terminals turn to that the NO-N point is closed while NC-N point is open. At this point, NO-N point can drive resistive loads: 125VAC/1A, 230VAC/1A, 30VDC/1A.

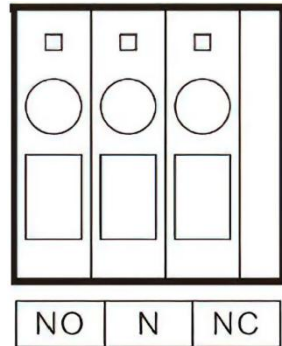

RS485 communication port:

This port is an RS485 communication port

RS485-2 allows direct communication with the optional host computer developed by our company through this port, and enables monitoring of the equipment running status and setting of some parameters on the computer.

As shown in the figure:

RS485-1: Pin 1 is 5V power supply, Pin 2 is GND, Pin 7 is RS485-A1, and Pin 8 is RS485-B1;

RS485-2: Pin 1 is 5V power supply, Pin 2 is GND, Pin 7 is RS485-A2, and Pin 8 is RS485-B2;

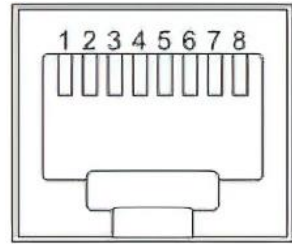

RS485

USB communication port:

This is a USB communication port, which can be used for USB communication with the optional PC host software. To use this port, you should install the corresponding "USB to serial chip CH340T driver" in the computer.

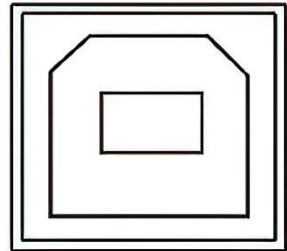

Parallel communication function (parallel operation only)

- This port is used for parallel communication, through which the parallel modules can communicate with each other.
- Each all-in-one machine has two DB15 ports, one for the male connector and the other for the female connector.
- When connecting, make sure to connect the male connector of the inverter with the female connector of the inverter to be paralleled, or connect the female connector of the inverter to the male connector of the inverter to be paralleled.
- Do not connect the male connector of the inverter to its female connector.

Female connector

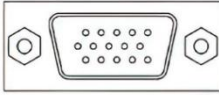

Male connector



Current sharing detection function (parallel operation only)

- a) This port is used for current sharing detection, through which the current sharing of the parallel modules can be detected (parallel operation only).
- b) Each all-in-one machine has two current sharing detection ports, which are connected in parallel. When it is connected to other models to be paralleled, either port can be connected to other models to be paralleled, either port can be connected for convenience. There is no special mandatory wiring requirements

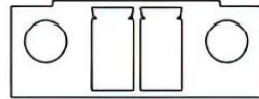

Battery communication interface

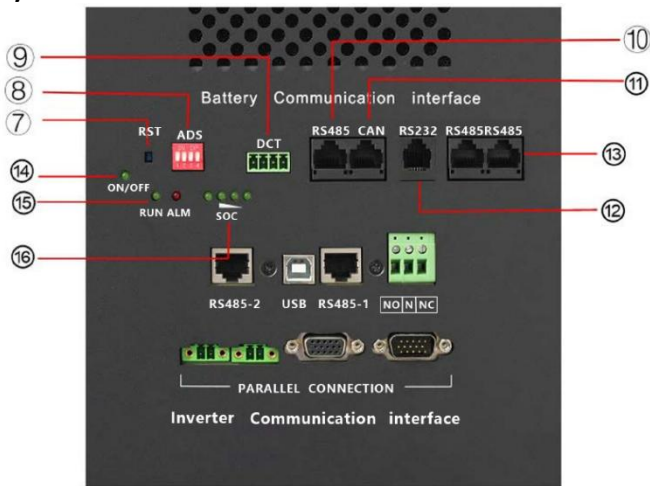

⑦ Reset	⑧ DIP Switch	⑨ Dry contact	⑩ RS485 (Connect inverter)
⑪ CAN (Connect inverter)	⑫ RS232	⑬ RS485 (connect PC)	⑭ LED (ON/OFF)
⑮ LED (RNU/ALM)	⑯ LED (SOC)		

1. RST: Reset button.
2. ADS: dial switch

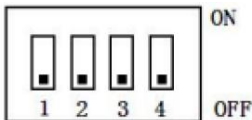

3. DCT: Dry contact interface
4. RS485: with dual RS485 interface, you can view the information of pack. The default baud rate is 9600bps. If it is necessary to communicate with the monitoring equipment through RS485, the monitoring equipment is used as the host, polling data according to the address, and the address setting range is 1 ~ 15.
5. CAN: CAN communication, baud rate 500K.
6. RS232: BMS can communicate with upper computer through RS232 interface, so as to monitor various information of battery, including battery voltage, current, temperature, status and battery production information, etc. the default baud rate is 9600bps.
7. Interface diagram

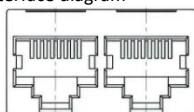

CAN and RS485 interface



Dry contact

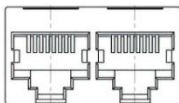





Parallel communication port



communication interface

8. Definition of electrical interface

Number	Communication	Function	Interface Type	Picture	instruction
⑫	RS232	Connect PC	RJ11-6P6C		2-NC 3-TX 4-RX 5-GND
⑩、⑬	RS485	Connect inverter/ paralleling	RJ45-8P8C		1、 8-RS485-B 2、 7-RS485-A 3、 6-GND 4、 5-NC
⑪	CAN	Connect inverter	RJ45-8P8C		9、 10、 11、 14、 16-NC 12-CANL 13-CANH 15-GND
②	RS485-2	Connect battery	RJ45-8P8C		1-5V 2-GND 7-RS485-A1 8-RS485-B1
③	RS485-1	Connect PC/Wifi	RJ45-8P8C		1-5V 2-GND 7-RS485-A2 8-RS485-B2



① Battery Power button	② Battery Display
③ Inverter Power button	④ Inverter Display
⑤ Active Balancer Power button (Optional)	

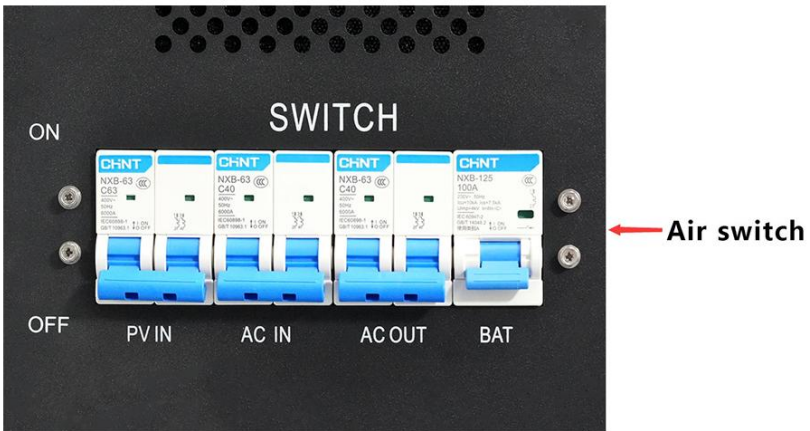

5 Application Scenarios

5.1 Application Scenarios

5.1.1 Application Scenarios with Only Mains Power but No Photovoltaic

When the mains are normal, it charges the battery and supplies power to the loads.

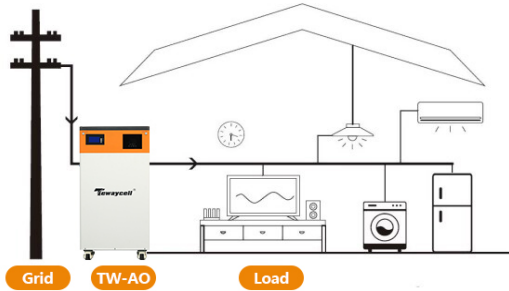

When the mains is disconnected or stops working, the battery supplies power to the load through the power module.

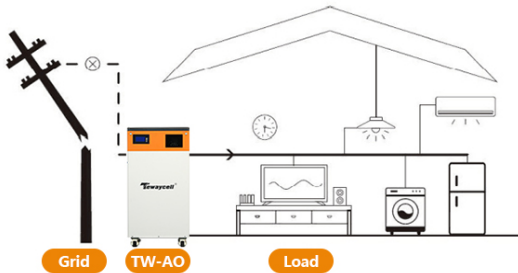

5.1.2 Application Scenarios with Only Photovoltaic but No Mains Power

During the day, the photovoltaic directly supplies power to the loads while charging

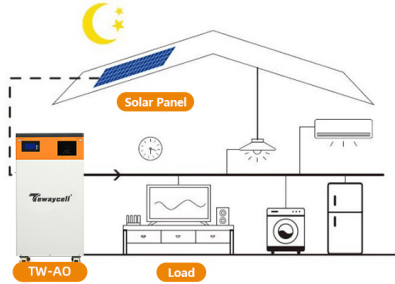

At night, the battery supplies power to the loads through the power module.

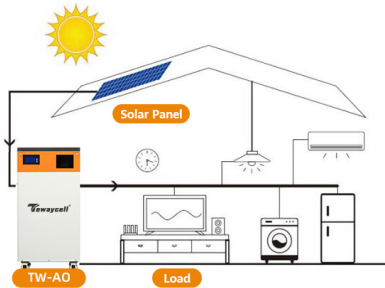

5.1.3 Complete Application Scenarios

During the day, the mains and photovoltaic simultaneously charge the battery and supply power to the loads.

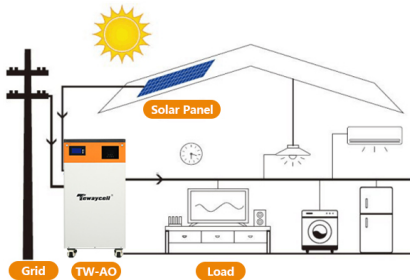

At night, the mains supplies power to the loads, and continue to charge the battery, if the battery is not fully charged.

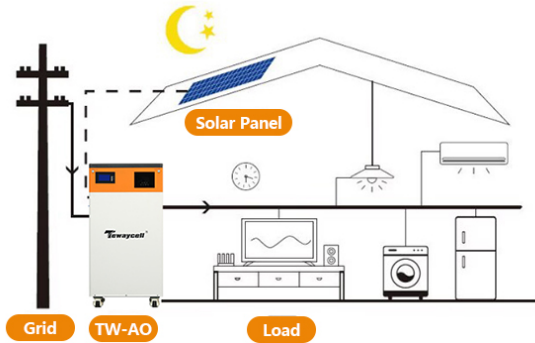

If the mains are disconnected, the battery supplies power to the loads.

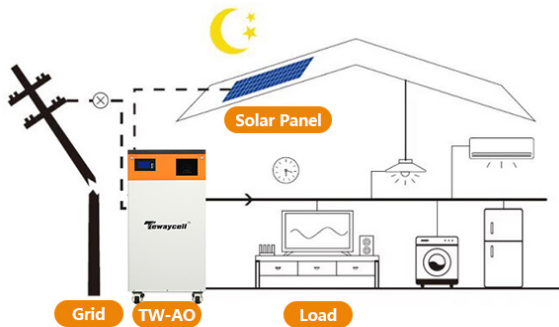

6 Installation instructions for all-in-one machine



6.1 Inspections before Installation

6.1.1 Inspection of outer package

Before opening outer package of the all-in-one machine, check if there is any visible damage on the outer package, such as holes, cracks or other signs of possible internal damage, and check the type of all-in-one machine. If there is any abnormality on the package or model of the all-in-one machine is inconsistent, do not open it and contact us as soon as possible.

6.1.2 Inspection of deliverables

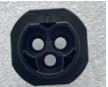
After opening outer package of the all-in-one machine, check if the deliverable is complete and whether there is any visible external damage. If any items are missing or damaged, please contact us.











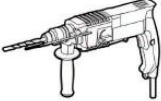



NO.	Picture	Item	Quantity	Specification
1		All-in-one Machine	1	
2		Inverter parallel communication line	1	
3		Inverter parallel communication line	1	
4		Photovoltaic connectors	2	
5		Three hole AC plug	2	
6		Disassembly and assembly tools for solar panel connectors	1	
7		operating manual	1	

6.2 Selection of Installation Location

6.2.1 Installation Space Requirements

When installing the all-in-one machine, certain space shall be left around it to ensure sufficient space for installation and heat dissipation. Determine the installation location; please choose a flat ground as the installation size.

6.2.2 Preparation of Tools and Meters

Types	Tools and meters		
Installation tool			
			  ①  ②
			
Personal protective equipment			
			

7 Electrical Connection



Before electrical connection, please ensure that the switches of the all-in-one machine are in the "OFF" state. Otherwise, the high voltage of the device may cause electric shock.



The operations related to electrical connections must be carried out by professional electrical technicians. When carrying out electrical connections, the operator must wear personal protective articles.

7.1 Internal Electrical Connection of All-in-one machine

7.1.1 Connecting Power Cord

Before connecting the all-in-one machine battery module, ensure that the all-in-one machine battery is not working and the indicator lights on the battery are OFF. Use proper power cord to connect the positive and negative terminals of other batteries or power modules. It shall be noticed that the red cable should be connected to the red terminal (positive battery terminal) and the black cable to the black terminal (negative battery terminal).

7.2 External Electrical Connection of All-in-one machine

7.2.1 Wiring specifications and circuit breaker selection

Wiring and installation must comply with national and local electrical codes. Recommended PV array wiring specifications and circuit breaker selection: Since the output current of the PV array is affected by the type, connection method and illumination angle of the PV module, the minimum wire diameter of the PV array is calculated according to its short-circuit current; refer to the short-circuit current value in the PV module specification (the short-circuit current is constant when the PV modules are connected in series; the short-circuit current is the sum of the short-circuit currents of all PV modules connected in parallel); the short-circuit current of the PV array shall not exceed the maximum input current.

➤ Refer to the table below for PV input wire diameter and switch

Models	Recommended PV wiring diameter	Maximum PV input current	Recommended air switch or circuit breaker type
HFP4850S80-145	10mm ² /7AWG	50A	2P-63A

Note: The voltage in series shall not exceed the maximum PV input open circuit voltage.

➤ Refer to the table below for recommended AC input wire diameter and switch:

Models	Recommended AC input wiring diameter	Maximum PV input current	Recommended air switch or circuit breaker type
HFP4850S80-145	10mm ² /7AWG	40A	2P-40A

Note: There is already an appropriate circuit breaker at the Mains input wiring terminal, so it is not necessary to add one more.

➤ Recommended battery input wire diameter and switch selection

Models	Recommended battery wiring diameter	Rated battery discharge	Maximum charge current	Recommended air switch or circuit breaker type
HFP4850S80-145	30mm ² /2AWG	85A	120A	2P-140A

➤ Recommended AC output wiring specifications and circuit breaker selection

Models	Recommended AC output wiring diameter	Rated AC output discharge	Maximum bypass output current	Recommended air switch or circuit breaker type
HFP4850S80-145	10mm ² /7AWG	30A	40A	2P-40A

Note: The wiring diameter is for reference only. If the distance between the PV array and the all-in-one solar charge inverter or the distance between the all-in-one solar charge inverter and the battery is relatively long, using a thicker wire can reduce the voltage drop to improve system performance.

Note: The above are only recommended wiring diameter and circuit breaker. Please select the appropriate wiring diameter and circuit breaker according to actual situations.

7.2.2 Installation and wiring



AC input / output wiring method:

- ① Prior to AC input/output wiring, disconnect the external circuit breaker and confirm that the wire used is thick enough. Please refer to Section 7.2.1 “Wiring Specifications and Circuit Breaker Selection”;
- ② Properly connect the AC input wire according to the wire sequence and terminal position shown in the figure below. Please connect the ground wire first, and then the live wire and the neutral wire;

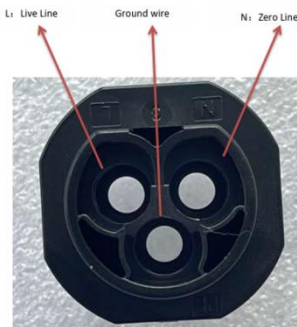

PV input wiring method:

Add: Building A, Xinlida Industrial Park, Junzibu Village, Guanlan Street, Longhua District, Shenzhen, Guangdong

TEL :0755-23225527 FAX:0755-23225537



7.3 Installation and wiring

7.3.1 Introduction

Maximum six all-in-one machines can be used for parallel operation.

When using the parallel operation function, the following connecting lines (package accessories) shall be firmly and reliably connected:

Parallel communication line*1:

Current sharing detection line*1:



7.3.2 Precautions for connecting the parallel connecting lines

1. Battery wiring:

Parallel connection in single or split phase: Ensure BAT + connected to BAT + , BAT -connected to BAT -, and that the connection is correct with the same wiring length and line diameter before power on and start-up, so as to avoid the abnormal operation of parallel system output caused by wrong connection.

2. AC OUT wiring:

Parallel connection in single phase: Ensure L-to-L, N-to-N and PE-to-PE connection for all all-in-one machines, and that the connection is correct with the same wiring length and line diameter before power on and start-up, so as to avoid the abnormal operation of parallel system output caused by wrong connection. For specific wiring, please refer to 7.3.3 Wiring Diagram.

Parallel connection in split phase: Ensure N-to-N and PE-to-PE connection for all all-in-one machines. The L lines of all inverters connected to the same phase need to be connected together. But L lines of different phases cannot be joined together. Other connection precautions are the same as parallel connection in single phase. For specific wiring, please refer to 7.3.4 Wiring Diagram.

3. AC IN wiring:

Parallel connection in single phase: Ensure L-to-L, N-to-N and PE-to-PE connection for all all-in-one machines, and that the connection is correct with the same wiring length and line diameter before power on and start-up, so as to avoid the abnormal operation of parallel system output caused by wrong connection. Meanwhile, it is not allowed to have multiple different AC source inputs to avoid damage to the external equipment of the inverter. The consistency and uniqueness of AC source input shall be ensured. For specific wiring, please refer to 7.4.3 Wiring Diagram.

Parallel connection in split phase: Ensure N-to-N and PE-to-PE connection for all all-in-one solar charger inverters. The L lines of all inverters connected to the same phase need to be connected together. But L lines of different phases cannot be joined together. Other connection precautions are the same as parallel connection in single phase. For specific wiring, please refer to 2.4.4 Wiring Diagram.

4. Wiring of parallel communication line:

Parallel connection in single or split phase: Single-phase or leaky phase parallel connection: The parallel communication line of our company is DB15 standard computer cable with shielding function. In addition, ensure that the parallel communication line of each all-in-one machine is tightened with the end screw of DB15 to avoid the abnormal operation or damage of the system output caused by the disconnection or poor contact of the parallel communication line.

5. Wiring of current sharing detection line:

Parallel connection in single phase: our current sharing detection line is twisted pair. When connecting each all-in-one machine, ensure the "one in and one out" rule, that is, connect the current-sharing line of the all-in-one machine with the current-sharing green port of the all-in-one machine to be connected in parallel (select one port from the two ports, there is no mandatory sequence requirement). The current-sharing ports of all-in-one machine cannot be connected with each other. In addition, ensure that the red and black current-sharing connecting lines of each all-in-one machine are not exchanged manually, and ensure that the lines are tightened with screws to avoid abnormal operation or system output damage caused by abnormal parallel current-sharing detection. See 7.3.3 wiring diagram for specific wiring.

Parallel connection in split phase: The current sharing detection lines of all all-in-one machine connected to the same phase need to be connected together. But the current sharing detection lines of different phases cannot be joined together. Other connection precautions are the same as parallel connection in single phase. For specific wiring, please refer to 7.3.4 Wiring Diagram.

7.3.3 Schematic diagram of parallel connection in single phase

In case of parallel operation with multiple inverters, the schematic diagram of parallel connection is as follows:

a) Two all-in-one machines of the system connected in parallel:

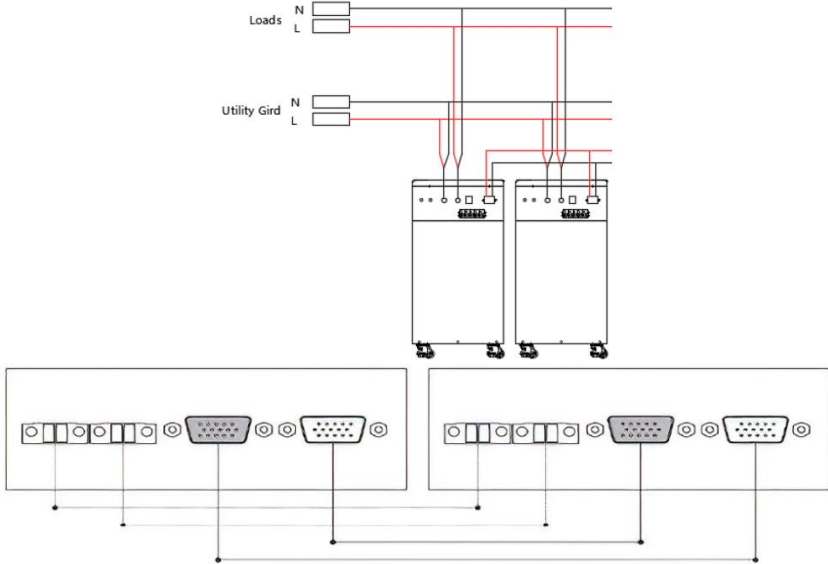

b) Three all-in-one machines of the system connected in parallel:

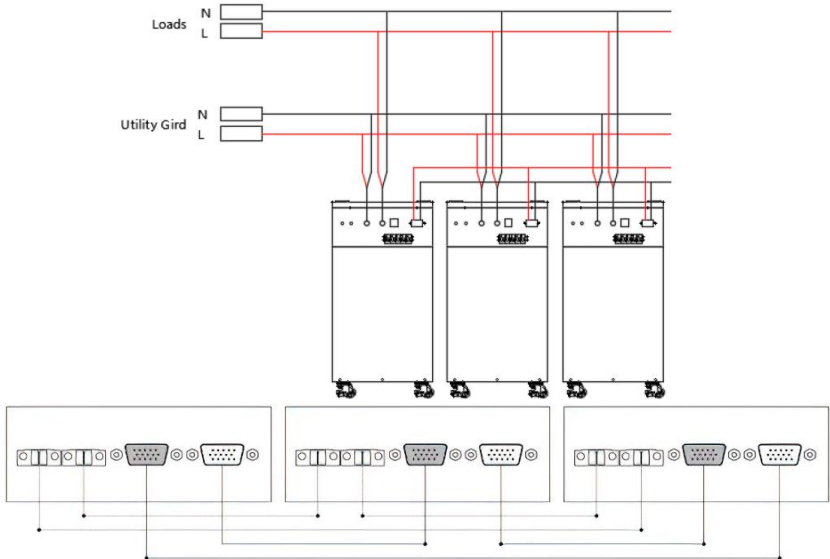

c) Four all-in-one machines of the system connected in parallel:

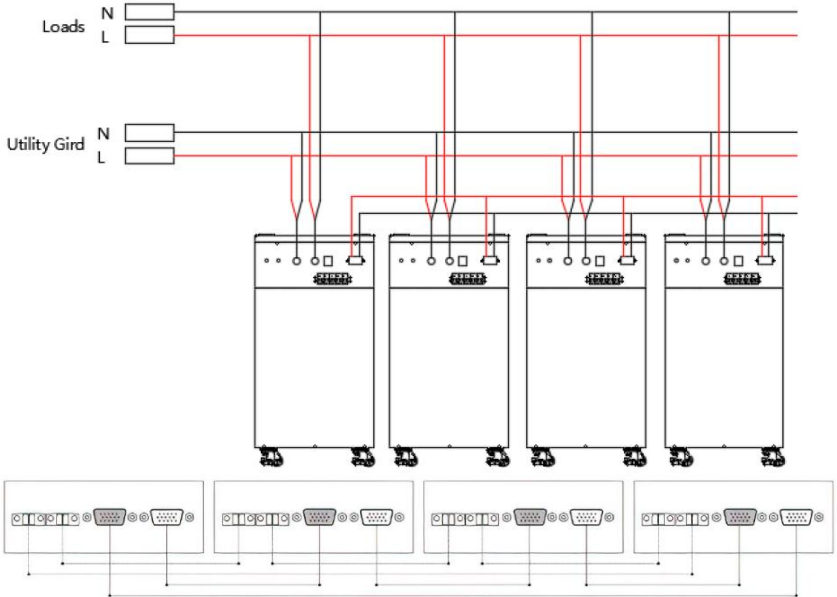

d) Five all-in-one machines of the system connected in parallel:

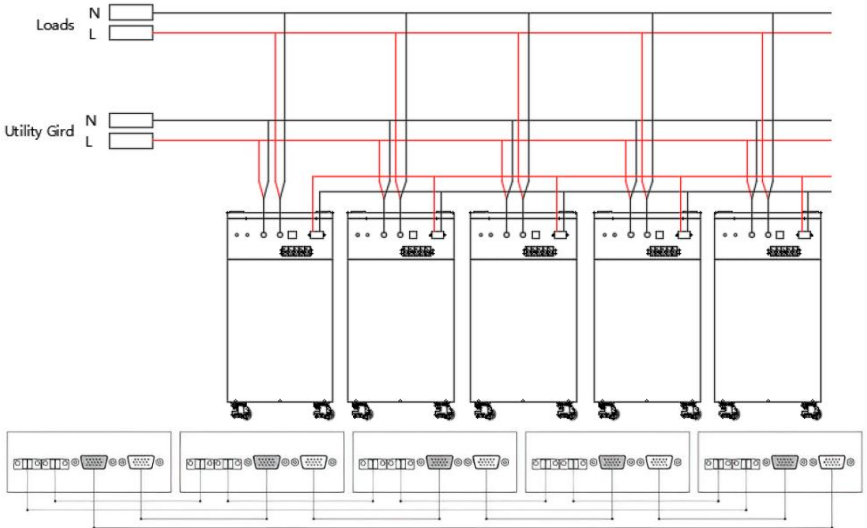

e) Six all-in-one machines of the system connected in parallel:

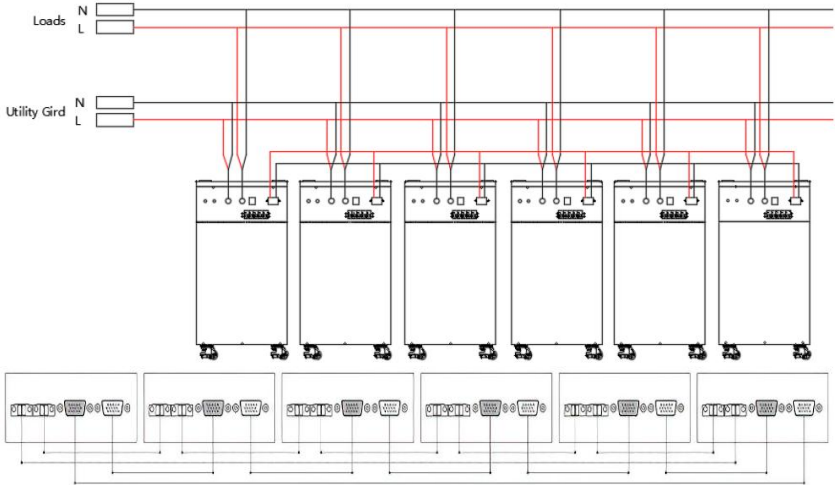

Parallel Operation in three phase:

a) Three all-in-one machines of the system connected in three phase: 1+1+1 system:

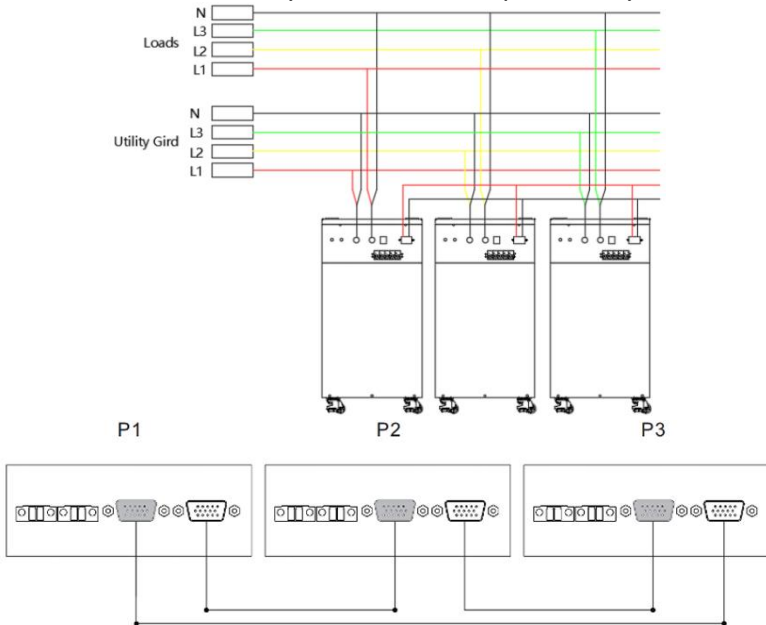

b) Four all-in-one machines of the system connected in three phase: 2+1+1 system:

Add: Building A, Xinlida Industrial Park, Junzibu Village, Guanlan Street, Longhua District, Shenzhen, Guangdong

TEL :0755-23225527 FAX:0755-23225537

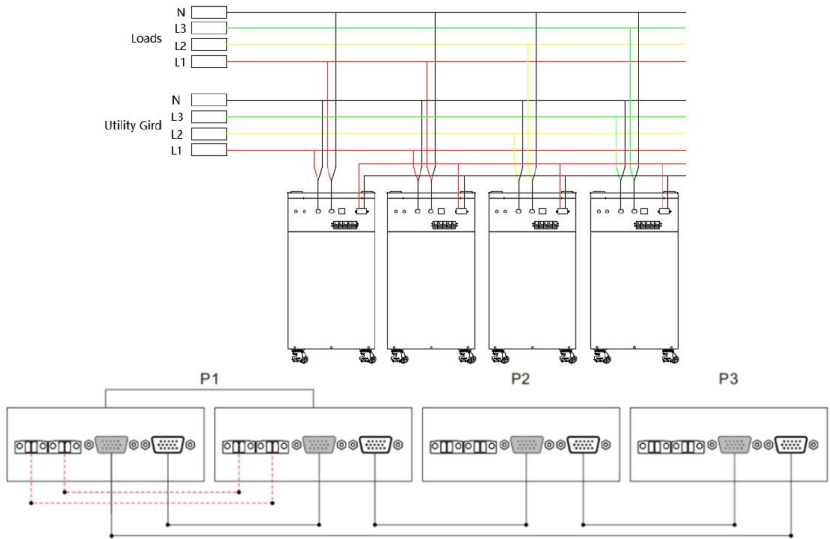

c) Five all-in-one machines of the system connected in three phase: 3+1+1 system:

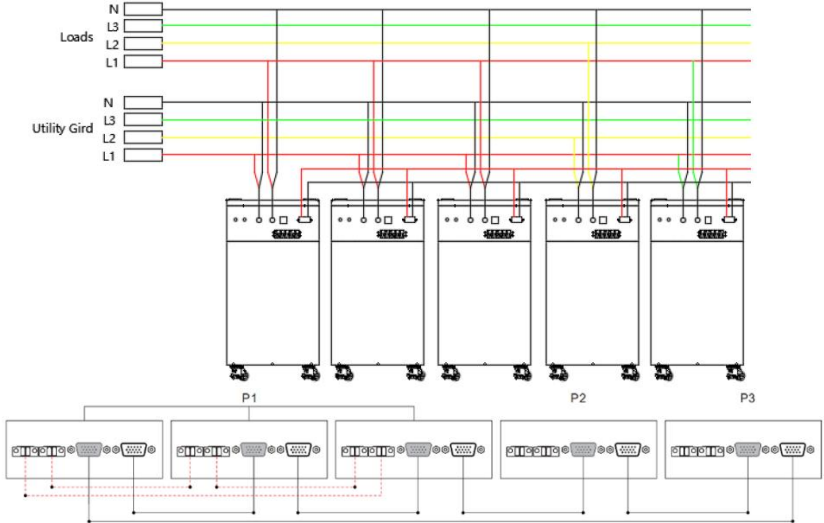

2+2+1 system:

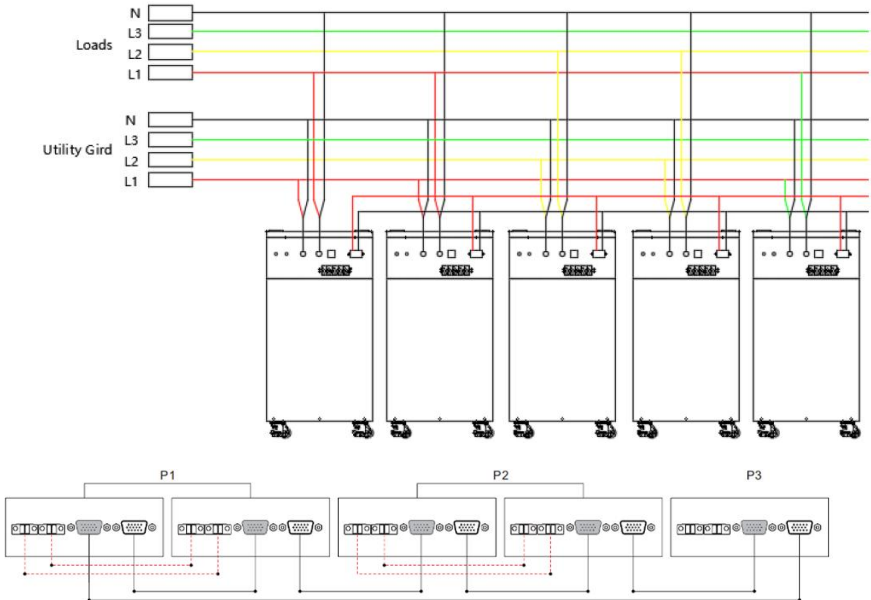

d) Six all-in-one machines of the system connected in three phase: 2+2+2 system:

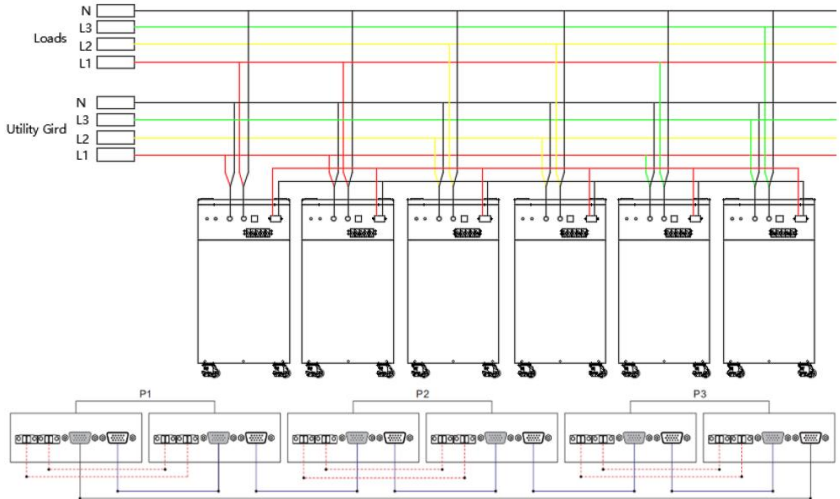

3+2+1 system:

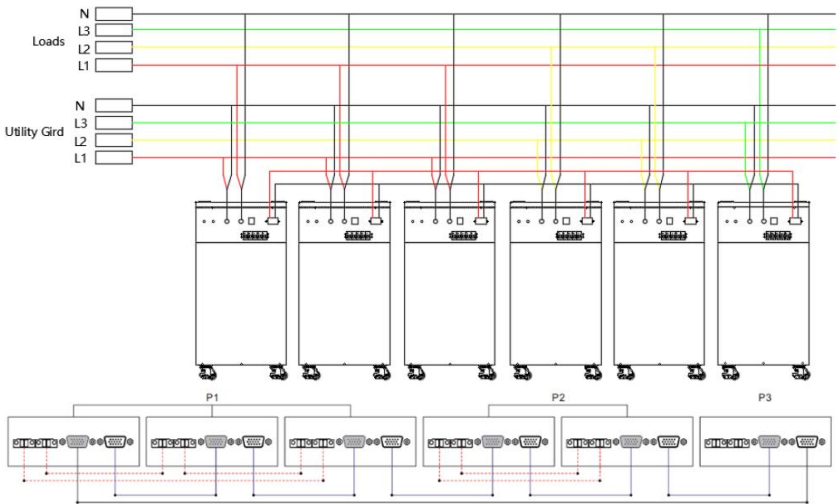

4+1+1 system:

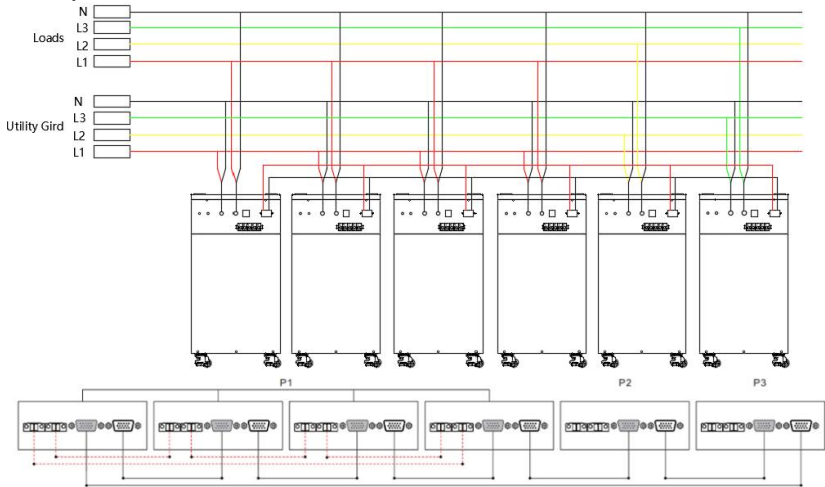

Note:

- Before starting up and running, please check whether the connection was correct to avoid any abnormalities in the system.
- All wiring must be fixed and reliable to avoid wire drop during use.
- When the AC output is wired to the load, it shall be properly wired according to the requirements of the electrical load equipment to avoid damage to the load equipment.
- Settings [38] need to be set consistently or only for the host. When the machine is running, the voltage set by the host shall prevail, and the master will force the rewrite of the other slave machines to keep the same set. Only can be set in the standby mode.
- When using parallel or split phase separation function, the [31] setting items need to be set accordingly.

Parallel Operation in two phase:

When the parameter [38] setting item=120. The [31] setting item:

All connected P1-phase inverters are set to "2P0":

If all connected P2-phase inverters are set to "2P1", the AC output line voltage difference is 120 degrees (L1-L2), line voltage is $120 \times 1.732 = 208\text{Vac}$; Phase voltage is 120Vac (L1-N; L2-N).

If all connected P2-phase inverters are set to "2P2", the AC output line voltage difference is 180 degrees (L1-L2), line voltage is $120 \times 2 = 240\text{Vac}$; Phase voltage is 120Vac (L1-N; L2-N).

Parallel Operation in three phase:

The [31] setting item:

All connected P1-phase inverters are set to "3P1";

All connected P2-phase inverters are set to "3P2";

All connected P3-phase inverters are set to "3P3";

When the parameter [38] setting item=120 for. The AC output line voltage difference is 120 degrees, each line voltage (L1-L2/L1-L3/L2-L3) is $120 \times 1.732 = 208\text{Vac}$; Each phase voltage is 120Vac (L1-N; L2-N; L3-N).

- When the phase sequence is set [31] on the screen, the setting one is turned on to set, and the other machines are turned off. One by one set. Finally, power off and start up again.
- After the system runs, the output voltage is measured correctly, and then the load setting is connected.

7.4 Inspections before Power-On

No.	Inspection items	Acceptance criteria	Validation
1	The all-in-one machine is installed in place	The installation is correct, secure and reliable.	<input type="checkbox"/> Yes <input type="checkbox"/> No
2	The installation environment Meets requirements	The installation space is reasonable and the environment is clean and tidy without any construction	<input type="checkbox"/> Yes <input type="checkbox"/> No
3	The power cord is correctly connected	The positive and negative terminals are connected correctly without any missing.	<input type="checkbox"/> Yes <input type="checkbox"/> No
4	The signal line is correctly connected	The signal line is connected reliably, and there is no wrong position	<input type="checkbox"/> Yes <input type="checkbox"/> No
5	The grounding is reliable	The grounding wire is correctly and reliably connected.	<input type="checkbox"/> Yes <input type="checkbox"/> No
6	The switch of the energy storage battery module is off	All switches connected to the all-in-one machine are in the "OFF" state.	<input type="checkbox"/> Yes <input type="checkbox"/> No

7.5 Power-On of All-in-one machine

1. Turn on the air switch of the all-in-one machine.

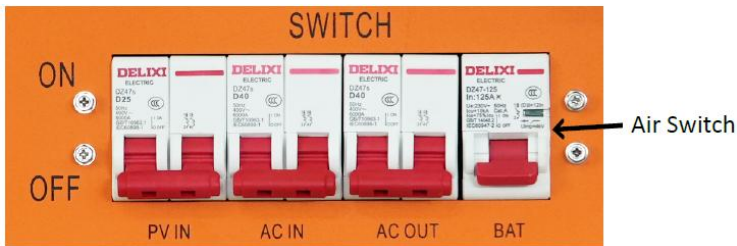

2. After turning on the air switch and confirming, turn on the switch of the all-in-one machine battery module, and then turn on the switch of the inverter.



Add: Building A, Xinlida Industrial Park, Junzibu Village, Guanlan Street, Longhua District, Shenzhen, Guangdong

TEL :0755-23225527 FAX:0755-23225537

3. After the power switch is turned on, the LED indicator will light up or flash. The meaning of the LED indicator is as follows.









System Status	Events	RUN	ALM
POWER OFF	Power Off	OFF	OFF
Steady	Normal	Blinking1	OFF
	Alarm	Blinking1	Blinking3
Charging	Normal	ON	OFF
	Alarm	ON	Blinking3
	High temperature, Over Current	OFF	ON
Discharging	Normal	Blinking3	OFF
	Alarm	Blinking3	Blinking3
	Over Discharge Protection	OFF	OFF
	Over Current, Short Current	OFF	ON

Table 1 LED blinking description

Blinking	LED ON	LED OFF
Blinking1	0.25S	3.75S
Blinking2	0.5S	0.5S
Blinking3	0.5S	1.5S

7.5.1 Capacity Indicator

Capacity indicator LED	SOC
	0~25%
	25~50%
	50~75%
	75~100%
 :LED ON  :LED OFF	

7.6 Operating modes

7.6.1 Charging mode

- a) PV priority: PV module will charge the battery preferentially, and the battery is charged by the Mains only when the PV system fails. During the day, solar energy is fully used to charge, while at night, it converts to the Mains. This can maintain battery level, and is ideal for areas where the grid is relatively stable and electricity price is relatively high.

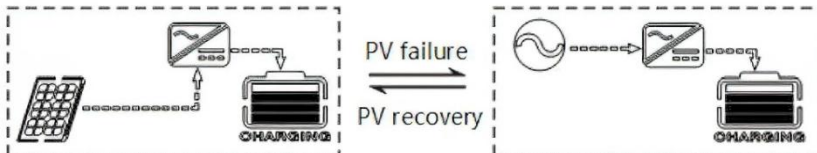

- b) Mains priority: The Mains supply is preferentially used to charge the battery. Only when the Mains fails, the PV charging can be activated.

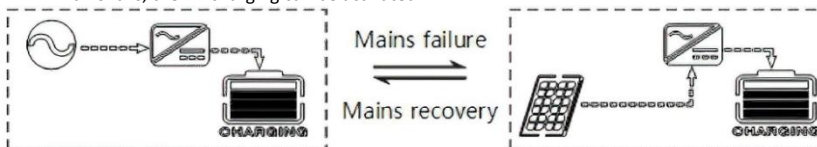

- c) Hybrid charging: PV and mains hybrid charging. PV MPPT charging is a priority, and when PV energy is insufficient, the mains supply supplements. When the PV energy is sufficient again, the mains stops charging. This is the fastest charging mode, suitable for the areas where power grid is unstable, providing sufficient backup power supply at any time.

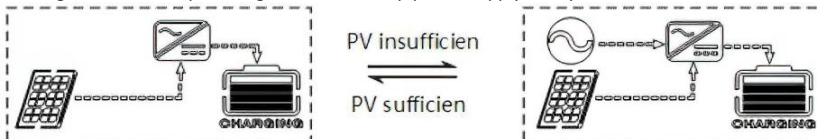

- d) Only Solar (Only Solar): Only PV charging, without Mains charging. This is the most energy-efficient way in which battery is charged only by solar panels, and is usually used in areas with good lighting conditions.

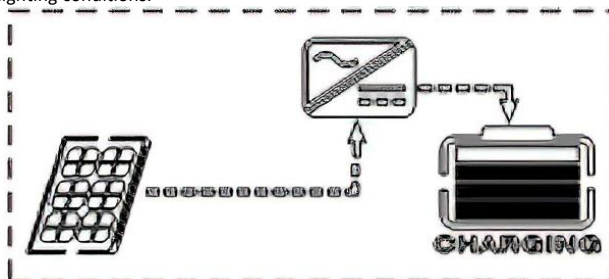

7.6.2 Output mode

➤ PV priority mode:

Switch to mains supply when the PV charging fails. This mode maximizes the use of solar energy while maintaining battery power, suitable for use in the areas with relatively stable grid. Power supply priority: Solar—» Utility—» Battery.

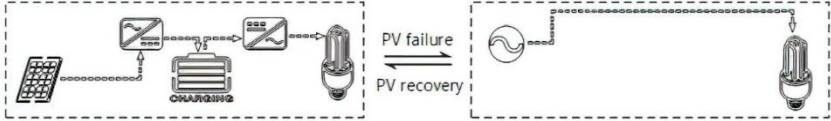

➤ Mains priority mode:

Switch to inverter only when the mains fails (when there was mains power, switch to mains power for charging and power supply). Then, the unit is equivalent to a backup UPS, suitable for areas with unstable grid. Switching does not affect PV charging. Power supply priority: Utility—» Solar—» Battery.



➤ Battery priority mode:

Switch to mains supply only when the battery discharge undervoltage is lower than the set point (item 04). When the charging battery is higher than the set point of (05 setting item), switch to the battery discharge mode. This can cycle the battery charge and discharge. This mode maximizes the use of DC power and is used in the area with stable grid. Switching does not affect PV charging. Power supply priority: Solar—» Battery—» Utility.

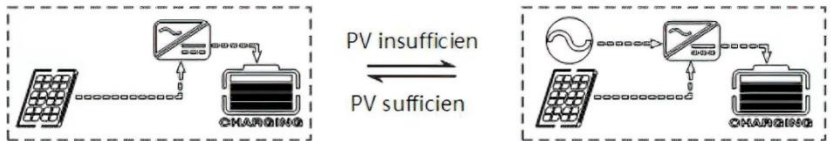

7.7 Inverter LCD Function Description

The operation and display panel is as shown below, including 1 LCD screen, 3 indicators and 4 operation buttons.

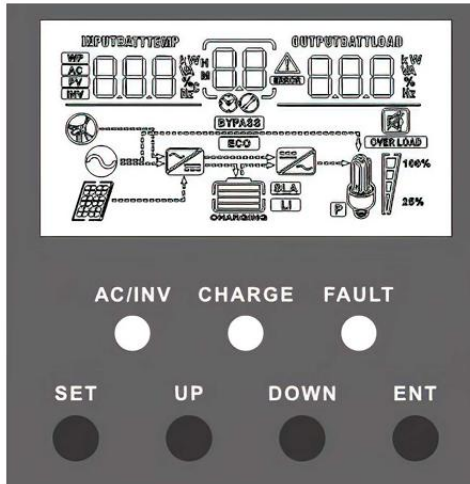









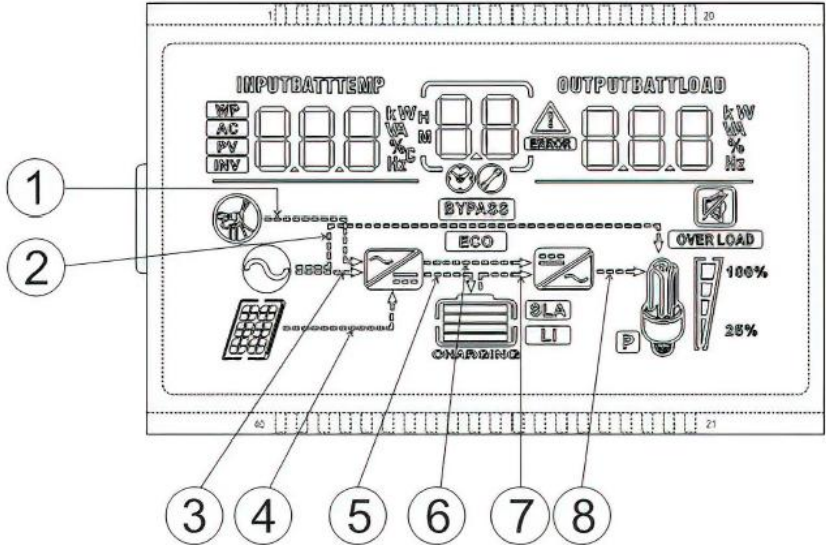



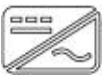



Operation buttons introduction





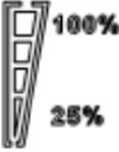











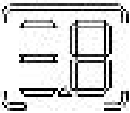

Function buttons	Description
SET	Enter/Exit Settings menu
UP	Previous choice
DOWN	Next choice
ENT	Confirm/Enter Options under the settings menu

Indicators introduction

Indicators	Colors	Description
AC/INV	Yellow	Steady on: Mains output
		Flash: Inverter output
CHARGE	Green	Flash: Fast charging
		Steady on: Floating charge
FAULT	Red	Flash : Fault state



Icons	Functions	Icons	Functions
	Indicates that the AC input terminal has been connected to the grid		Indicates that the inverter circuit is working
	Indicates that the AC input mode in APL mode (wide voltage range)		Indicates that the machine is in the Mains Bypass mode
	Indicates that the PV input terminal has been connected to the solar panel		Indicates that the AC output is in an overload state
	Indicates that the machine has been connected to the battery:  indicates that the remaining battery is 0%~24%;  indicates that the remaining battery is 25%~49%;  indicates that the remaining battery is 50%~74%;  indicates that the remaining battery is 75%~100%.		Indicates the percentage of AC output loads:  indicates that the load percentage is 0%~24%;  indicates that the load percentage is 25%~49%;  indicates that the load percentage is 50%~74%;  indicates that the load percentage is ≥75%

	Indicates that the battery type of the machine is a lithium battery		Indicates that the buzzer is not enabled
	Indicates that the current battery type of the machine is a lead-acid battery		Indicates that the machine has an alarm
	Indicates that the battery is in charging state		Indicates that the machine is in a fault condition
	Indicates that the AC/PV charging circuit is working		Indicates that the machine is in setup mode
	Indicates that the AC output terminal has an AC voltage output		The parameters displayed in the middle of the screen: In the non-setup mode, the alarm or fault code is displayed. In the setup mode, the currently set parameter item code is displayed.
	In parallel operation, this icon indicates that this inverter is the host, which is only valid in parallel mode.		
Parameters display on the left side of the screen: input parameters			
	Indicates AC input		
	Indicates PV input		
	Indicates inverter circuit		
	This icon is not displayed		
	Display battery voltage, battery charge total current, mains charge power, AC input voltage, AC input frequency, PV input voltage, internal heat sink temperature, software version		
Parameters display on the right side of the screen: Output parameters			
	Indicates output voltage, output current, output active power, output apparent power, battery discharge current, software version; in setup mode, displays the set parameters under the currently set parameter item code		
Arrow display			
	The arrow is not displayed		Indicates the charging circuit charging the battery terminal

②	Indicates the grid supplying power to the load	⑥	The arrow is not displayed
③	Indicates grid supplying power to the charging circuit	⑦	Indicates the battery terminal supplying power to the inverter circuit
④	Indicates PV module supplying power to the charging circuit	⑧	Indicates the inverter circuit supplying power to the load

7.7.1 Real-time data viewing method

On the LCD main screen, press the “UP” and “DOWN” buttons to scroll through the real-time data of the machine.

Page	Parameters on the left side of the screen	Parameters in the middle of the screen	Parameters on the right side of the screen
1	INPUT BATT V (Battery input voltage)	Fault code	OUTPUT LOAD V (Output load voltage)
2	PV TEMP °C (PV charger heat sink temperature)		PV OUTPUT KW (PV output power)
3	PV INPUT V (PV input voltage)		PV OUTPUT A (PV output current)
4	INPUT BATT A (Input battery current)		OUTPUT BATT A (Battery output current)
5	INPUT BATT KW (Battery input power)		OUTPUT BATT KW (Battery output power)
6	AC INPUT Hz (AC input frequency)		AC OUTPUT LOAD Hz (AC output frequency)
7	AC INPUT V (AC input voltage)		AC OUTPUT LOAD A (AC output load current)
8	INPUT V (For maintain)		OUTPUT LOAD KVA (Load apparent power)
9	INV TEMP °C (AC charge or battery discharge heat sink temperature)		INV OUTPUT LOAD KW (Load active power)
10	APP software version		Boot loader software version
11	Model Battery Voltage Rating		Model Output Power Rating
12	Model PV Voltage Rating		Model PV Current Rating
13	RS485 Address Number		Phase Sequence Number

7.7.2 Setup parameters description

Buttons operation instructions: Press the “SET” button to enter the setup menu and exit the setup menu. After entering the setup menu, the parameter number [00] will flash. At this point, press the “UP” and “DOWN” buttons to select the code of parameter item to be set. Then, press the “ENT” button to enter the parameter editing mode, and the value of the parameter is flashing. Adjust the value of the parameter with the “UP” and “DOWN” buttons. Finally, press the “ENT” button to complete the parameter editing and return to the parameter selection state.

Note: in parallel mode, all machines will synchronize the setting parameters of the host (the machine with "P" is displayed on the display screen) before startup. After startup, the setting parameters of any machine will be synchronized to other machines in the system.

Parameter no.	Parameter name	Settings	Description
00	Exit setting menu	[00] ESC	Exit the setup menu
01	Output source priority	[01] SOL	PV priority mode, switching to the Mains when the PV fails or the battery is lower than the set value of parameter [04].
		[01] UTI default	Mains priority mode, switching to inverter only when the mains fails.
		[01] SBU	Battery priority mode. Switch to mains power only when the battery is under voltage or lower than the setting value of parameter [04]; Switch to battery discharge only when the battery is fully charged or higher than the setting value of parameter [05].
02	Output Frequency	[02] 50.0	Bypass self-adaptation; when the mains are connected, it automatically adapts to the mains frequency; when the mains are disconnected, and the output frequency can be set through this menu. The default output frequency of the 230V machine is 50HZ.
		[02] 60.0	
03	AC Input Voltage Range	[03] APL	Wide mains input voltage range of 230V machine: 90~280V
		[03] UPS default	Narrow mains input voltage range of 230V machine: 90~280V
04	Battery Power to Utility Set point	[04] 46.0 default	When the parameter [01] =SBU, the battery voltage is lower than the set value, and the output is switched from the inverter to the mains. Setting range: 44V~52V.
05	Utility to Battery Power Set point	[05] 56.0V default	When the parameter [01] =SBU, the battery voltage is higher than the set value, and the output is switched from the mains to the inverter. Setting range: 48V~60V.

06	Charger source priority	[06] CSO	PV priority charging; only when the PV charging fails, the mains charging is started.
		[06] CUB	Mains priority charging; only when the mains charging fails, the PV charging is started.
		[06] SNU default	PV and Mains hybrid are charging; PV charging is a priority, and when the PV energy is insufficient, the Mains charging supplements. When the PV energy is sufficient, the Mains charging stops. Note: Only when the Mains bypass output is loaded, the PV charging and the mains charging can work at the same time. When the inverter works, only the PV charging can be restarted.
		[06] OSO	Only PV charging, with the Mains charging not activated.
07	Max charger current	[07] 80A default	Max charger current (AC charger + PV charger). setting range 0~140A.
08	Battery Type	[08] USE	User-defined; all battery parameters can be set.
		[08] SLd	Sealed lead-acid battery; constant-voltage charge voltage: 57.6V, floating charge voltage: 55.2V.
		[08] FLd	Vented lead-acid battery; constant-voltage charge voltage: 58.4V, floating charge voltage: 55.2V.
		[08] GEL default	Colloidal lead-acid battery; constant-voltage charge voltage: 56.8V, floating charge voltage: 55.2V.
		[08] LF14/LF15/LF16	Lithium iron phosphate battery LF14/LF15/LF16, corresponding to 14 strings, 15 strings and 16 strings of lithium iron phosphate battery; for 16 strings, default constant-voltage charge voltage is 56.8V; for 15 strings, default constant-voltage charge voltage is 53.2V; for 14 strings, default constant-voltage charge voltage is 49.2V; allow adjustable.
		[08] N13/N14	Ternary lithium battery; which is adjustable.
09	Battery boost charge voltage	[09] 57.6V default	Boost charge voltage setting; the setting range is 48V~58.4V, with step of 0.4V; it is valid for user-defined battery and lithium battery.
10	Battery boost charge time	[10] 120 default	Boost charge maximum time setting, which means the maximum charging time to reach the set voltage of parameter [09] during constant-voltage charging. The setting range is 5min~900min, with a step of 5 minutes. It is valid for user-defined battery and lithium battery.
11	Battery floating charge voltage	[11] 55.2V default	Floating charge voltage, setting range: 48V~58.4V, step: 0.4V, valid when battery type is user-defined.

12	Battery over discharge voltage (delay off)	[12] 42V default	Over-discharge voltage; when the battery voltage is lower than this judgment point, delay the time set by parameter [13] and turn off inverter output. Setting range is 40V~48V, with a step of 0.4V. It is valid for user-defined battery and lithium battery.
13	Battery over discharge delay time	[13] 5S default	Over-discharge delay time; when the battery voltage is lower than the parameter [12], the inverter output will be turned off after the time set by this parameter is delayed. The setting Range is 5S~55S, with a step of 5S. It is valid for user-defined battery and lithium battery.
14	Battery under voltage alarm	[14] 44V default	Battery under voltage alarm point; when the battery voltage is lower than the point, an under voltage alarm is given, and the output is not turned off; the setting range is 40V~52V, with a step of 0.4V. It is valid for user-defined battery and lithium battery.
15	Battery discharge limit voltage	[15] 40V default	Battery discharge limit voltage; when the battery voltage is lower than the point, the output is turned off immediately; the setting range is 40V~52V, with a step of 0.4V. It is valid for user-defined battery and lithium battery.
16	Battery equalization enable	[16] DIS	Equalizing charge is disabled
		[16] ENA default	Equalizing charge is enabled, only valid for vented lead-acid battery and sealed lead-acid battery
17	Battery equalization voltage	[17] 58.4V default	Equalizing charge voltage; setting range: 48V~58.4V, with a step of 0.4V; valid for vented lead-acid battery and sealed lead-acid battery
18	Battery equalized time	[18] 120 default	Equalizing charge time; setting range: 5min~900min, with a step of 5 minutes; valid for vented lead-acid battery and sealed lead-acid battery
19	Battery equalized time out	[19] 120 default	Equalizing charge delay; setting range: 5min~900min, with a step of 5 minutes; valid for vented lead-acid battery and sealed lead-acid battery
20	Battery equalization interval	[20] 30 default	Equalizing charge derating time, 0~30days, with a step of 1 day; valid for vented lead-acid battery and sealed lead-acid battery
21	Battery equalization immediately	[21] DIS default	Stop equalizing charge immediately.
		[21] ENA	Start equalizing charge immediately.

22	Power saving mode	[22] DIS default	Power saving mode disabled.
		[22] ENA	After the power saving mode is enabled, if the load is null or less than 50W, the inverter output is turned off after a delay for a certain period of time. When the load is more than 50W, the inverter automatic restart.
23	Restart when over load	[23] DIS	Automatic restart when overload is disabled. If an overload occurs and the output is turned off, the machine will not restart.
		[23] ENA default	Automatic restart when overload is enabled. If an overload occurs and the output is turned off, the machine will restart after a delay of 3 minutes. After it reaches 5 cumulative times, the machine will not restart.
24	Restart when over temperature	[24] DIS	Automatic restart when over temperature is disabled. If an over-temperature shutdown occurs, machine will not restart to turn the output on.
		[24] ENA default	Automatic restart when over temperature is enabled. If an over-temperature shutdown occurs, the machine will restart when the temperature drops.
25	Alarm enable	[25] DIS	Alarm is disabled
		[25] ENA default	Alarm is enabled
26	Beeps while primary source is interrupted	[26] DIS	Alarm beep is disabled when the status of the main input source changes
		[26] ENA default	Alarm beep is enabled when the status of the main input source changes
27	Bypass output when over load	[27] DIS	It is disabled to automatically switch to the Mains when the inverter is overloaded.
		[27] ENA default	It is enabled to automatically switch to the Mains when the inverter is overloaded.
28	Max AC charger current	[28] default	Max AC charger current. Setting range: 0~60A; 60A default.
29	Split Phase	[29] DIS default	Supply for industrial frequency transformer (disabled)
		[29] ENA	Supply for industrial frequency transformer (enabled)
30	Model ID setting	[30] 1 default	RS485 address number. Parallel mode needs to be set in the range of 1-6. When the power is first turned on, it will be automatically distributed

31	AC output mode (can be set in the standby mode only)	[31] SIG	When single inverter is used, the default is SIG mode.
		[31] PAL default	In parallel operation with single phase, Please refer to 7.2.1 Wiring Diagram.
		[31] 3P1/3P2/3P3	In split phase operation with three phases, Please refer to 7.2.1 Wiring Diagram.
		When the parameter [38] setting item=230. All connected P1-phase inverters are set to "3P1"; All connected P2-phase inverters are set to "3P2"; All connected P3-phase inverters are set to "3P3"; AC output line voltage difference is 120 degrees (L1-L2/L1-L3/L2-L3), each line voltage is $230 \times 1.732 = 398\text{Vac}$; Each phase voltage is 230Vac (L1-N; L2-N; L3-N).	
32	RS485-1 communication	[32]SLA default	RS485-2 port for PC or telecommunication control
		[32]BMS	RS485-2 port for BMS communication.
33	Battery BMS communication	When the parameter [32] setting item =BMS, you can choose to match the battery manufacturer's BMS protocol to communicate with BMS for the lithium battery protection	
		PAC=PACE, RDA=Ritar, AOG=ALLGRAND BATTERY, OLT=OLITER, HWD=SUNWODA, DAQ=DAKING, WOW=SRNE, PYL=PYLONTECH, UOL=WEILAN	
35	Battery under voltage recovery point	[35] 52V default	When the battery voltage is under voltage, the battery voltage needs to recover more than this set value before the inverter starts the output
36	Max PV charger current	[36] 80A default	Max PV charger current. Setting range:0~80A
37	Battery fully charged recovery point	[37] 52V default	After the battery is fully charged, it needs to be lower than this set voltage before it can be recharged
38	AC output voltage setting (only can be set in the standby mode)	[38] default	Allow to set to 200/208/220/230/240Vac. The rated output power will be reduced= (Power Rate)*(Vset/230)

7.8 Battery LCD Function Description



Button Description:
 MENU: enter the management system.
 Enter: enter the submenu.
 Down: moves the cursor down or to the next page.
 ESC: returns to the previous one

After the power module works Normally , the LCD is described as follow:

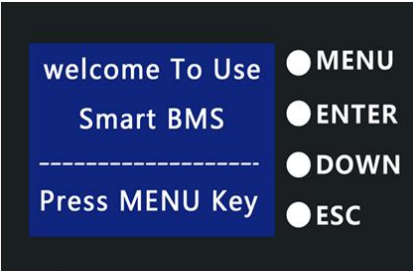

① Press "MENU" to enter the main menu.

Note: "»" indicates that there is a submenu. Press "ENTER" to enter the submenu

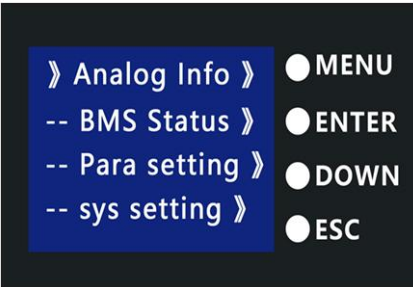

Analog Info	≥
BMS Status	≥
Para Setting	≥
Sys Setting	≥

Move the cursor to "Analog info" and press "Enter"

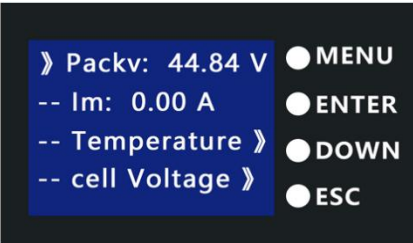

PackV:	xxV
Im	xxA
Temperature	≥
Cell Voltage	≥
CellCapacity	≥

Move the cursor to "Temperature" and press "Enter" to check the battery temperature information, then press "DOWN" to turn the page.

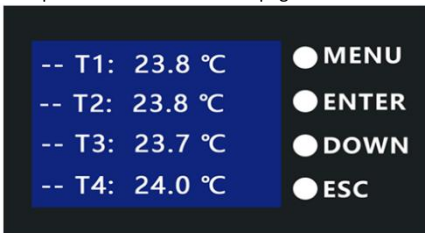

T1	xx °C
T2	xx °C
T3	xx °C
T4	xx °C
PCB-T	xx °C
ENV-T	xx °C

Move the cursor to "Cell Voltage" and press "Enter" to check the battery voltage information, then press "Down" to turn the page



Cell01	xxxx mV
Cell02	xxxx mV
Cell03	xxxx mV
Cell04	xxxx mV
.....
Cell14	xxxx mV
Cell15	xxxx mV
Cell16	xxxx mV

Move the cursor to "CellCapacity" and press "Enter" to check the battery capacity information.



SOC	X %
FCC	X AH
Rm	X AH
CC	0

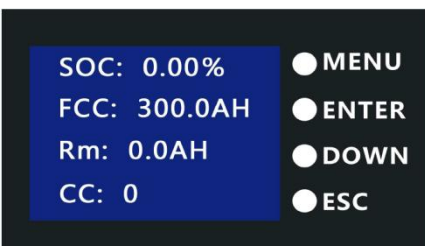

Move the cursor to "BMS Status", press "Enter" to check the battery status.

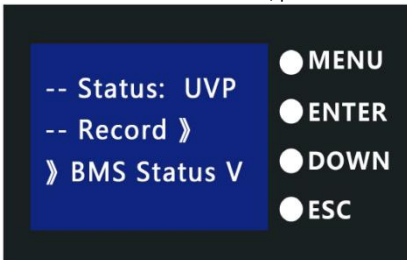

Status	UVP
Record	»
BMS Status	»

Move the cursor to "Record", then press "Enter" to check the battery alarm information, then press "DOWN" to turn the page.



SCP	
O/UTP	
OCP	
UVP	
OVP	

Move the cursor to "BMS Status", then press "Enter" to check the battery protection information, and then press "DOWN" to turn the page.



UV	Y/N
UVP	Y/N
OC	Y/N
OCP	Y/N
OT	Y/N
OTP	Y/N
OV	Y/N
OVP	Y/N
SCP	Y/N

Move the cursor to "Para Setting" and press "Enter" to check the gyroscope information.

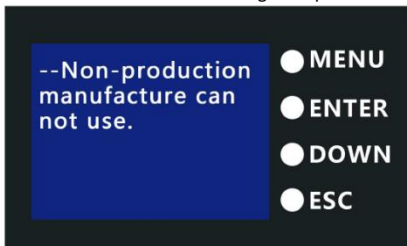

Move the cursor to "Sys Setting", then press "Enter" to check the version information.

Add: Building A, Xinlida Industrial Park, Junzibu Village, Guanlan Street, Longhua District, Shenzhen, Guangdong

TEL :0755-23225527 FAX:0755-23225537



Hibernation and activation functions

After 1 minute of button-free operation in normal operation, the display will turn off (backlight only), and pressing any button while the screen is off will allow the screen to light up and function normally.

8 System Maintenance

8.1 System Power-Off



After the system is powered off, the case still has residual power and heat, which may cause electric shocks or burns. Therefore, protective gloves should be worn before operating the all-in-one machine 5 minutes after the system is powered off. Maintenance operations on all-in-one machine should be performed only after ensuring that all indicator lights of the all-in-one machine are off.

Power-off operation steps of the system:

Step 1 Turn off the breaker switch between the inverter and AC output (If installed).

Step 2 Turn off the breaker switch between the inverter unit and AC input (If installed).

Step 3 Turn off the breaker switch between the inverter unit and the PV string (If installed). Step 4

Turn off the battery breaker switch, all LED indicators are off.

Step 5 Turn off button on all all-in-one machine modules, the all-in-one machine is powered off successfully.

8.2 Routine Maintenance

To ensure the long-term and good operation of the all-in-one machine system, it is recommended to perform the routine maintenance as described in this section.

Item	Method	Maintenance interval
System cleanliness	Check if the radiator is covered or dirt on a regular basis.	Once every six months to one year.
Running status of system	<ul style="list-style-type: none"> ● Observe whether the all-in-one machine appearance is ● Damaged or deformed. Listen to whether the all-in-one machine has any abnormal sound during running. ● When the all-in-one machine is running, check whether the indicator of the all-in-one machine battery is correct. 	Once every six months.
Electrical connection	<ul style="list-style-type: none"> ● Check if any cable connection is off or loose. ● Check if any cable is damaged, and especially if there are cuts on the sheath where the cable contacts with the metal surface. ● Check if the unused DC input terminals, all-in-one machine terminals, COM ports, and covers are locked. 	Half a year after first debugging and testing, and once every six months to one year thereafter.
Grounding reliability	Check if the grounding cable is grounded reliably.	Half a year after first debugging and testing, and once every six months to one year thereafter.

8.3 Trouble shooting

8.3.1 Fault Code and Handling Methods

Fault code	Fault name	Whether it affects the output or not	Description
【01】	BatVoltLow	NO	Battery undervoltage alarm
【02】	BatOverCurrSw	Yes	Battery discharge average current overcurrent software protection
【03】	BatOpen	Yes	Battery not-connected alarm
【04】	BatLowEod	Yes	Battery undervoltage stop discharge alarm
【05】	BatOverCurrHw	Yes	Battery overcurrent hardware protection
【06】	BatOverVolt	Yes	Charging overvoltage protection
【07】	BusOverVoltHw	Yes	Bus overvoltage hardware protection
【08】	BusOverVoltSw	Yes	Bus overvoltage software protection
【09】	PvVoltHigh	No	PV overvoltage protection
【10】	PvBoostOCSw	No	Boost overcurrent software protection
【11】	PvBoostOCHw	No	Boost overcurrent hardware protection
【12】	bLineLoss	No	Mains power down
【13】	OverloadBypass	Yes	Bypass overload protection
【14】	OverloadInverter	Yes	Inverter overload protection
【15】	AcOverCurrHw	Yes	Inverter overcurrent hardware protection
【17】	InvShort	Yes	Inverter short circuit protection
【19】	OverTemperMppt	No	Buck heat sink over temperature protection
【20】	OverTemperInv	Yes	Inverter heat sink over temperature protection
【21】	FanFail	Yes	Fan failure
【22】	EEPROM	Yes	Memory failure
【23】	ModelNumErr	Yes	Model setting error
【26】	RlyShort	Yes	Inverted AC Output Backfills to Bypass AC Input
【29】	BusVoltLow	Yes	Internal battery boost circuit failure
【30】	BatCapacityLow1	No	Alarm given when battery capacity rate is lower than 10% (setting BMS to enable validity)
【31】	BatCapacityLow2	No	Alarm given when battery capacity rate is lower than 5% (setting BMS to enable validity)
【32】	BatCapacityLowStop	Yes	Inverter stops when battery capacity is low (setting BMS to enable validity)
【34】	CanCommFault	Yes	CAN communication fault in parallel operation
【35】	ParaAddrErr	Yes	Parallel ID setting error
【36】	-	-	-
【37】	ParaShareCurrErr	Yes	Parallel current sharing fault
【38】	ParaBattVoltDiff	Yes	Large battery voltage difference in parallel

Add: Building A, Xinlida Industrial Park, Junzibu Village, Guanlan Street, Longhua District, Shenzhen, Guangdong

TEL :0755-23225527 FAX:0755-23225537

			mode
【39】	ParaAcSrcDiff	Yes	Inconsistent AC input source in parallel mode
【40】	ParaHwSynErr	Yes	Hardware synchronization signal error in parallel mode
【41】	InvDcVoltErr	Yes	Inverter DC voltage error
【42】	SysFwVersionDiff	Yes	Inconsistent system firmware version in parallel mode
【43】	ParaLineContErr	Yes	Parallel line connection error in parallel mode
【44】	Serial number error	Yes	If the serial number is not set by omission in production, please contact the manufacturer to set it
【45】	Error setting of split phase mode	Yes	【31】 Settings item setting error
【58】	BMS communication error	NO	Check whether the communication line is connected correctly and whether [33] is set to the corresponding lithium battery communication protocol
【59】	BMS alarm	NO	Check the BMS fault type and troubleshoot battery problems
【60】	BMS battery low temperature alarm	NO	BMS alarm battery low temperature
【61】	BMS battery over temperature alarm	NO	BMS alarm battery over temperature
【62】	BMS battery over current alarm	NO	BMS alarm battery over current
【63】	BMS low battery alarm	NO	BMS alarm low battery
【64】	BMS battery over voltage alarm	NO	BMS alarm battery over voltage

8.3.2 Common Faults and Handling Methods

Faults	Handling measures
No display on the screen	Check if the battery air switch or the PV air switch has been closed; if the switch is in the "ON" state; press any button on the screen to exit the screen sleep mode.
Battery overvoltage protection	Measure if the battery voltage exceeds rated, and turn off the PV array air switch and Mains air switch.
Battery under voltage protection	Charge the battery until it returns to the low voltage disconnection recovery voltage.
Fan failure	Check if the fan is not turning or blocked by foreign object.
Heat sink over temperature protection	When the temperature of the device is lower than the recovery temperature, Normal charge and discharge control is resumed.
Bypass overload protection, inverter overload protection	① Reduce the use of power equipment; ② Restart the unit to resume load output.
Inverter short circuit protection	① Check the load connection carefully and clear the short-circuit fault points; ② Re-power up to resume load output.
PV overvoltage	Use a multimeter to check if the PV input voltage exceeds the maximum allowable input voltage rated.
Battery missed alarm	Check if the battery is not connected or if the battery circuit breaker is not closed.

8.4 Battery Storage and Maintenance

8.4.1 Battery Storage Requirements



Do not put the battery into fire. The battery may explode. Do not open or damage the battery. The electrolyte flowing out from the battery is harmful to the skin and eyes. The electrolyte may also be toxic;

- When being stored, the batteries shall be placed correctly in accordance with the marks on the packing case. Do not put them upside down or on the side.
- When stacking up the battery packing cases, the stacking requirements on the outer package shall be met.
- The batteries should be handled with care, and damage to batteries should be strictly prohibited.
- Requirements for the storage environment:
 - Ambient temperature: -10°C to 55°C , recommended storage temperature: 20°C to 30°C .
 - Relative humidity: 5%RH-80%RH.
 - Dry, well ventilated, and clean.
 - The corrosive organic solvents, gases and other substances shall be kept away.
 - Exposing to direct sunlight shall be avoided.
 - The distance from the heat source should not be less than two meters.
- When being stored, the battery shall be disconnected from the external connection. If there is an indicator light on the battery panel, the indicator light shall be off.
- The warehouse keeper shall make monthly statistics on the battery storage, and regularly inform the planning link of the battery inventory. If any battery has been stored for nearly 15 months (-10°C to 25°C), 9 months (25°C to 35°C), or 6 months (35°C to 55°C), recharging shall be arranged in time.

Add: Building A, Xinlida Industrial Park, Junzibu Village, Guanlan Street, Longhua District, Shenzhen, Guangdong

TEL :0755-23225527 FAX:0755-23225537

7. When the stored batteries are going to be delivered, the first-in first-out principle should be followed.
8. After the battery is produced and tested, it shall be recharged to at least 50% SOC before being stored. If the device will not be used for a long period of time, discharge the battery to 45% to 60% of the battery capacity and disconnect the battery output to avoid the battery runs out;
9. Do not touch the battery pack with wet hands.
10. Do not squeeze, drop, or pierce the battery.
11. The battery should always be disposed in accordance with local safety regulation.
12. The battery should be stored and recharged in accordance with this User's Manual.
13. Do not reverse polarity of the battery when storing or transporting the batteries, the batteries shall not be stacked up without protective packaging, and the number of stacked packed batteries should not exceed the number specified on the packaging.
14. All operators of the all-in-one machine system shall comply with the user manual, installation and service manual, and quality assurance requirements. Any damage to the device resulting from neglecting or misreading of the user's manual, installation and service manual, and the quality assurance requirements will invalidate the product warranty.

8.4.2 Requirements for Charging of Battery

The batteries to be stored for a long period of time (unused, for more than 3 months) must be kept in a dry and cool place. The storage voltage is 51V-53V. The batteries should be stored in a clean environment of $23 \pm 2^{\circ}\text{C}$ and humidity of 45%-75%. If the battery will be shelved and not used for a long period of time, it should be recharged every 3 months to ensure that the battery voltage is within the above range.

As for batteries and long-term storage, routine maintenance is required. Please charge the battery to 40% SOC at a current of 0.2C according to the requirements in the table below.

Ambient temperature for storage	Relative humidity for storage environment	Storage Time	SOC
<-10℃	/	Prohibited	/
-10~25℃		≤12 months	
25~35℃	5%~70%	≤6 months	30%≤SOC≤60%
35~45℃		≤3 months	
>45℃	/	Prohibited	/

8.5 Device Cleaning

It is recommended to clean and maintain the product from time to time. When cleaning, the dust and stains on the product shall be removed with a piece of soft dry cloth or vacuum cleaner, especially when cleaning the heat dissipation and air vents on both sides of the product. The product shall not be cleaned with organic solvents, corrosive liquids and other cleaning products. If the fan fails, it can be replaced by a professional.

9 Technical Data

BATTERY TECHNICAL SPECIFICATION		TW-AO-MB51100-5KW-EU
Battery model	TW-MB51100-100A-HWB	
Number of batteries	1	
Battery Energy	5.12KWH	
Battery Capacity	100AH	
Weight(Approx.)		
Dimension Lx Dx H	660.0*450.0*300.0	
Battery Type	LiFePO4	
Battery Rated Voltage	51.2V/48.0V	
Battery Working Voltage Range	44.8 ~ 57.6V	
Maximum Charging Current	100A	
Maximum Discharging Current	100A	
DOD Designed Life-span	80%	
>6000 Cycles @ 0.2C/25℃ Charging/Discharging at 80%DOD,Until 80% Capacity.		
INVERTER TECHNICAL SPECIFICATION		
INVERTER TECHNICAL	HFP4835S80-145	
PV CHARGE		
Solar Charge Type	MPPT	
Maximum Output Power	4400W	
PV Charging Current Range	0-50A	
PV Operating Voltage Range	60-145Vdc	
MPPT Voltage Range	60-115Vdc	
AC CHARGE		
Maximum Charge Power	3150W	
AC Charging Current Range	0~60A	
Rated Input Voltage	220/230Vac	
Input Voltage Range	(90Vac-280Vac)±2%	
AC OUTPUT		
Rated Output Power	5000W	
Maximum Output Current	24A	
Frequency	50Hz ± 0.3Hz/60Hz ± 0.3Hz	
Overload Current	40A	
BATTERY INVERTER OUTPUT		
Rated Output Power	4500VA	
Maximum Peak Power	5000VA	
Power Factor	1	
Rated Output Voltage (Vac)	230Vac	
Frequency	50Hz	
Auto Switch Period	<15ms	
THD	<3%	
GENERAL DATA		
Communication	RS485/CAN/WIFI	
Storage time/temperature	6 months @25℃;3 months @35℃;1 months @45℃;	
Charging temperature range	0~45℃	
Discharging temperature range	-10~45℃	
Operation Humidity	5% ~ 85%	
Nominal Operation Altitude	<2000m	
Cooling Mode	Force-Air Cooling	

Add: Building A, Xinlida Industrial Park, Junzibu Village,Guanglan Street, Longhua District ,Shenzhen, Guangdong

TEL :0755-23225527 FAX:0755-23225537

Noise	60dB(A)
Ingress Protection Rating	IP20
Recommended Operation Environment	Indoor
Installation Method	Vertical
Certification	UN38.3,MSDS,EN55032,EN55024,EN61000-3-2,EN61000-3-3

10 Optional function

10.1 Active equilibrium module

Qualification	Data specification
Balance Current	≤5A
Balance Mode	Active equilibrium
Balance on Condition	Reach the user-defined opening voltage and differential pressure Minimum voltage of single unit ≥ 3.2V (factory default) and equalizing opening differential pressure: ≥50mV (factory default)
Balance Closing Condition	Closing voltage and differential pressure reaching the user-defined setting Minimum voltage of single unit < 3.2V (factory default) and equalizing differential pressure: < 50mV (factory default)
Working Power Consumption	<1mA
Sleep Current	100uA
Working Temperature	-20℃ ~ 60℃

11 Fire extinguishing function

The battery is equipped with an aerosol fire extinguishing device. When the battery experiences a short circuit and catches fire, the fire extinguishing device can detect the temperature and automatically extinguish the fire.



Item	Parameter
Model specifications	QRR0.04G/S-MC-40-F-02-11
Working temperature range	-30℃ ~ +70℃
Relative humidity of working environment	≤95%RH
Start mode	Hot start
Spray time	≤3s
Starting temperature of thermal initiator	170±10℃

Add: Building A, Xinlida Industrial Park, Junzibu Village, Guanlan Street, Longhua District, Shenzhen, Guangdong

TEL :0755-23225527 FAX:0755-23225537