



Warranty
10
YEAR

Tested
IEC
62471

Compliant
CE
RoHS

Rated
IP
50

Connector
5-PIN
M12

PRODUCT HIGHLIGHTS

- ✓ 5-pin M12 quick connect
- ✓ Built-in smart driver
- ✓ PNP and NPN trigger signal input
- ✓ Intensity adjustable from 10%–100% using built-in potentiometer



PRODUCT INTRODUCTION

The S75 Brick Light Series is a spot light that features a built-in smart driver. NPN or PNP trigger signals can be used to control the on/off input of the light. Intensity of the light can be controlled via 1–10VDC analog signal line or by adjusting the built-in manual potentiometer. Heat is dissipated through the aluminum backplate, which allows the S75 Brick Light Series to be run at a higher intensity current.



PRODUCT SPECIFICATIONS

Electrical Input	24VDC +/-5%
Input Current	Max. 400 mA
Input Power	Max. 9.6 W
PNP Trigger	2.8 mA @ 4VDC 8.8 mA @ 12VDC 17.6 mA @ 24VDC
NPN Trigger	14.4 mA @ Ground (0 VDC)
Trigger Input	PNP > +4 VDC (24 VDC max.) to activate or NPN ≥ GND <1VDC to activate (not both)
Power Indicator	Turns green when powered up
Strobe Indicator	Strobe indicator will turn yellow when on
Intensity Limit	270° turn pot — intensity control of 10%–100%. Turn clockwise to increases intensity.
Analog Intensity	The output is adjustable from 10%–100% of intensity limit by a 1–10VDC signal. (Jumping pin 5 to pin 1 will provide maximum intensity.)
Connection	5-pin M12 connector
Operating Temperature	-10° to 40° C (14° to 104° F) RH max 80% non-condensing humidity
Storage Temperature	-10° to 40° C (14° to 104° F) RH max 80% non-condensing humidity
IP Rating	IP50
Weight	~155 g
Compliances	CE, RoHS, IEC 62471
Warranty	UV LEDs have a 2 year warranty, all other LEDs have a 10 year warranty. For complete warranty information, visit smartvisionlights.com/warranty .



WIRING CONFIGURATION

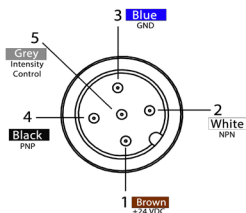

Pin layout for light (Male Connector)

Pin	Function	Signal	Wire Color
1	Power In	+24VDC	BROWN
2	NPN	Sinking Signal	WHITE
3	GND	Ground	BLUE
4	PNP	Sourcing Signal	BLACK
5	Intensity Control	1–10VDC	GREY*

* Some cables use green/yellow for pin 5

For maximum intensity, tie pin 5 to pin 1 at +24VDC.

For continuous mode: Tie PNP (pin 4) can be tied to +24VDC (pin 1) **or** tie NPN (pin 2) can be tied to Ground (pin 3).

OPTIONAL

For maximum intensity, connect pin 5 to pin 1 at 24VDC.
Potentiometer intensity needs to be set to 100%.



RESOURCE CORNER

Additional resources, including CAD files, videos, and application examples, are available on our website.



LIGHT PATTERNS

Smart Vision Lights recommends that the S75 be used at a working distance between 300 mm and 4000 mm.

Beam Diameter (White Light) — 5700K

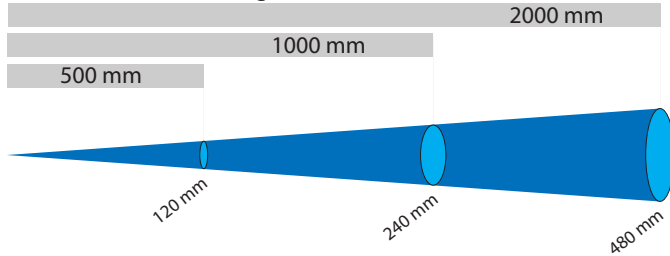

Beam Diameter (White Light) — 5700K

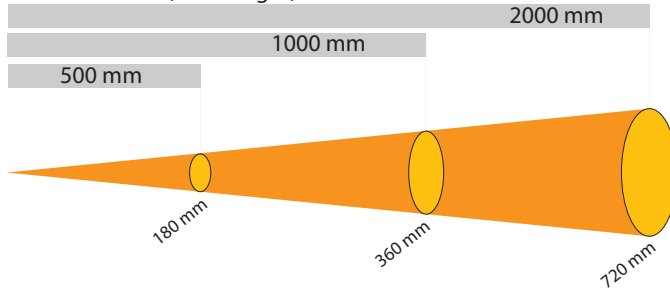

Beam Diameter (White Light) — 5700K

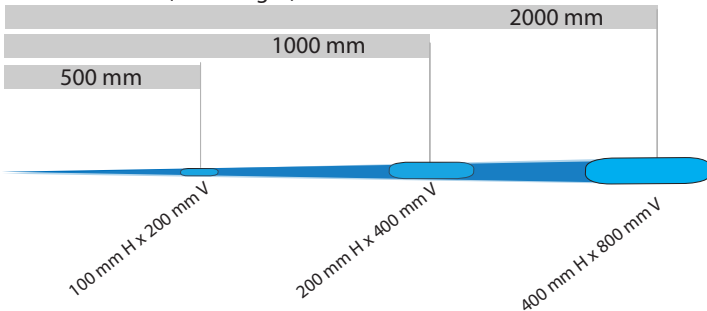

LIGHTING PATTERN FOR THE S75 with Narrow (Standard) Lenses

Working Distance mm (inches)	Pattern (80%–100% measured intensity) mm (inches)
500 mm (19.7")	120 mm (~4.7") D
1000 mm (39.4")	240 mm (~9.4") D
2000 mm (78.8")	480 mm (~18.9") D

Typical Output Performance	Illuminance (Lux)
Distance = 500 mm	7250
<i>Illuminance measurement taken on White Lights — 5700K</i>	

LIGHTING PATTERN FOR THE S75 with Wide (W) Lenses

Working Distance mm (inches)	Pattern (80%–100% measured intensity) mm (inches)
500 mm (19.7")	180 mm (~7") D
1000 mm (39.4")	360 mm (~14.2") D
2000 mm (78.8")	720 mm (~28.3") D

Typical Output Performance	Illuminance (Lux)
Distance = 500 mm	6500
<i>Illuminance measurement taken on White Lights — 5700K</i>	

LIGHTING PATTERN FOR THE S75 with Line (L) Lenses

Working Distance mm (inches)	Pattern (80%–100% measured intensity) mm (inches)
500 mm (19.7")	100 mm (~3.9") H x 200 mm (~7.8") V
1000 mm (39.4")	200 mm (~7.8") H x 400 mm (~15.7") V
2000 mm (78.8")	400 mm (~15.7") H x 800 mm (~31.5") V

Typical Output Performance	Illuminance (Lux)
Distance = 500 mm	9800
<i>Illuminance measurement taken on White Lights — 5700K</i>	

The S75 Brick Light produces a uniform light pattern.

Working Distance = 500 mm Grid set to 25 mm x 25 mm

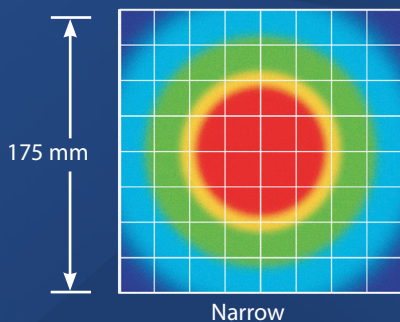

Narrow

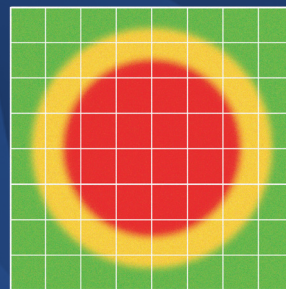

Wide

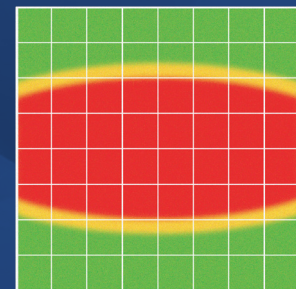

Line

PRODUCT DRAWING

CAD files available on our website.
Dimensions are in mm.

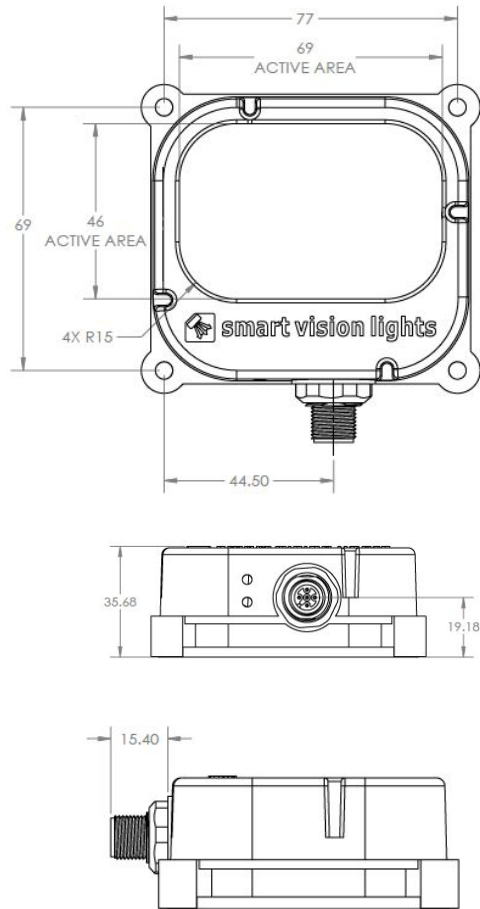

ILLUMINATION

S75 Series of Brick Lights works best for:

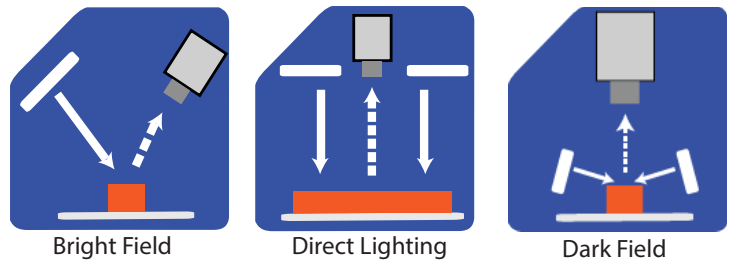

EYE SAFETY



According to IEC 62471:2006. Full documentation available upon request.

Notice

Exempt Group: No photobiological hazard to eyes or skin even for continuous, unrestricted use. Applicable for wavelengths 625, 850, 940, 1050, 1200, 1300, 1450, 1550, and 1650.

Caution

Risk Group 1: Possibly hazardous optical radiation emitted from this product. Do not stare at operating lamp. May be harmful to eyes. Safe for most applications except prolonged exposure. Applicable for wavelengths 470, 505, 530, and WHI.

Caution

Risk Group 2: UV emitted from this product. Eye or skin irritation may result from exposure. Use appropriate shielding. Does not pose optical hazard if aversion responses limit exposure. Applicable for wavelengths 365 and 395



PART NUMBER

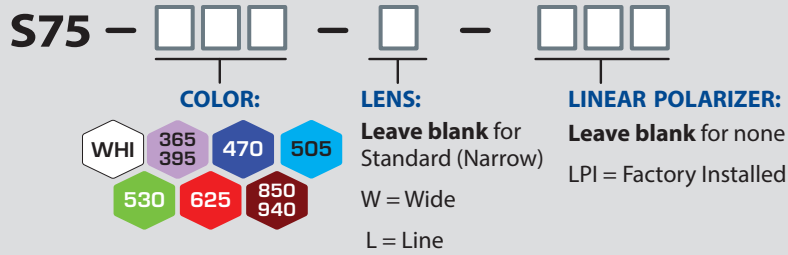

Part Number Examples:

- S75-625** S75, 625 nm Red Wavelength, Standard (Narrow) Lens
- S75-WHI-L** S75, White, Line Lens
- S75-470-W-LPI** S75, 470 nm Blue Wavelength, Wide Lens, with Linear Polarizer installed

Line Lenses are not offered for UV wavelengths.

Additional wavelengths and lens options available upon request.



LENS OPTICS

NARROW (STANDARD)

Narrow, 14° angle-cone lenses are standard. Standard lenses project a narrow beam of illumination and are used for long working distances.

WIDE

Wide, 30° angle-cone lenses project a large area of illumination. They create a floodlight effect, can be used for short working distances.

LINE

Line, with a 10° width and a 50° fan-angle project a thin, narrow beam of illumination. Note: this lens is not offered in UV.

* Additional lens options available upon request.

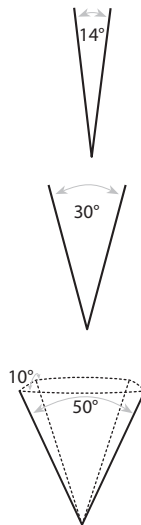

When To Use a Linear Polarizer?

Polarizing filters can reduce reflections on specular surfaces.

A Linear Polarizer has a typical transmission of 38 percent while blocking 62 percent of the light not in the polarization plane.

WARNING: Running a light in continuous operation while using a standard polarizer with certain wavelengths (e.g. white, blue) may burn the polarizer.



MOUNTING

Mounting options on the S75 Series of Brick Light include four holes. See Accessories for additional mounting options.

Example of the S75 using the Pan and Tilt Mount
(Part Number: PB75-M5.)

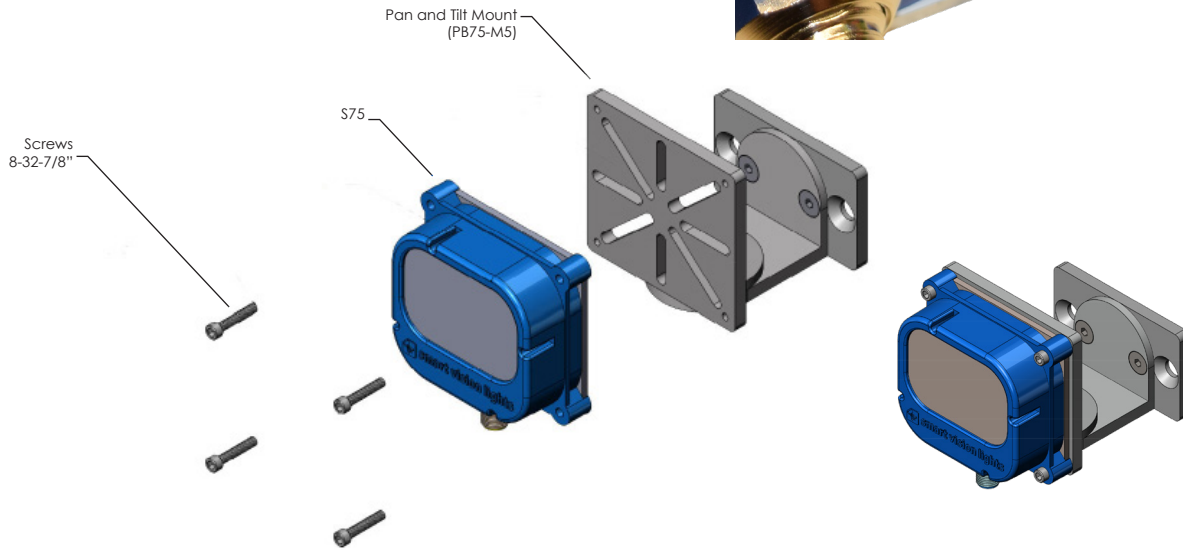
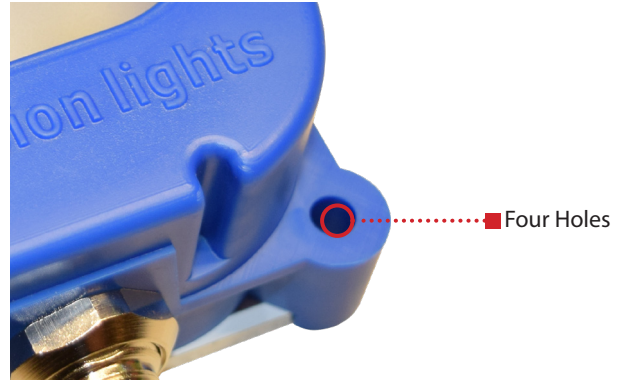



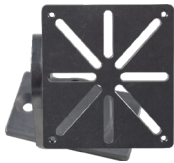

ACCESSORIES

Power Cables	
	
Length	Part Number
5 m	5PM12-5
10 m	5PM12-10
15 m	5PM12-15

Mount	
	
Description	Part Number
Pan and Tilt Mount	PB75-M5

Linear Polarizer	
	
Description	Part Number
Linear Polarizer for S75	S75-LP

Diffuser	
	
Description	Part Number
Diffuser Kit for S75	S75-DKIT



GLOSSARY

This glossary covers all Smart Vision Lights product families; some content in this section may not apply to this specific light.

TERMINOLOGY

OverDrive™ Light includes an integrated high-current strobe driver for complete LED light control.

Continuous Operation Light stays on continuously.

Multi-Drive™ Combines continuous operation and OverDrive™ strobe (high-current strobe operation) modes into one easy-to-use light.

Built-In Driver The built-in driver allows full function without the need for an external driver.

Camera to Light Connect the light directly to the camera, without the need for additional controllers or equipment.

Polarizers Filters that reduce reflections on specular surfaces.

Diffuser Used to widen the angle of light emission, reduce reflections, and increase uniformity.

TYPES OF ILLUMINATIONS

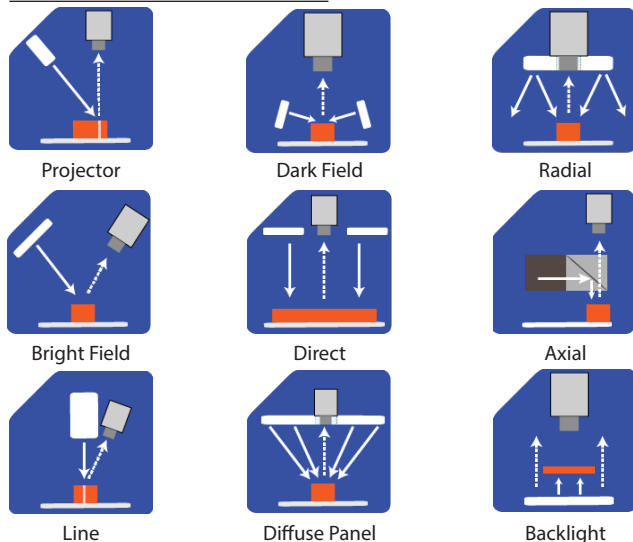

COLOR/WAVELENGTHS LEGEND

Wavelength options range from 365 nm to 1550 nm. Additional wavelengths available for many light families.

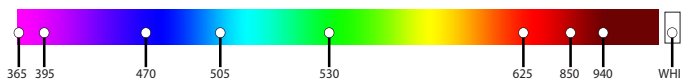

See Part Number section for **this light's** available standard wavelengths.



Shortwave infrared LEDs are available in 1050 nm, 1200 nm, 1300 nm, 1450 nm, and 1550 nm.

Check Part Number section to see if **this light** is available in SWIR wavelengths.