

Monochrome laser printer



## Lexmark MS817n



### High speed and volume to support large workgroups

When you have a printer supporting 10-20 busy people, you need the speed, input capacity and output volume provided by the MS817n. With print speeds up to 55 pages per minute, input capacity expandable to 4,400 sheets, an optional High Yield cartridge that produces up to 25,000 pages and recommended print volume of up to 50,000 pages per month, this device can handle even the busiest office.

### Keeps jobs moving. Faster.

The MS817n improves your print speeds by taking advantage of its 512MB of memory (upgradable to 2.5GB), dual-core processor and Gigabit networking. It can produce your first page in as little as 4.8 seconds.



Up to 55 ppm



Network



Finishing function



Security



Mobility



2.4-inch display

### Security. Confidential Print. Mobile print capability.

Extensive network security features and protocols protect your device, information and network from unauthorized access.

Keep your sensitive documents safe by enabling the Confidential Print feature, which requires entering a customized, unique PIN on the device's keypad before the document can be printed.

Print from mobile devices using an optional Wi-Fi adapter or Lexmark's free Mobile Print app.

### Makes document production easy

Produce presentation-ready documents with optional finishing features, such as stapling and hole punching.

The bright 2.4-inch color display lets you easily configure even complicated jobs.

### Comprehensive warranty

The affordable MS817n is so well made, we back it with a solid 1-year warranty that offers you multiple ways to obtain help: phone, email, live chat and remote assistance. Plus, if your device ever fails, we'll ship you a replacement device through our Advanced Exchange program so you're up and printing again as quickly as possible. See Statement of Limited Warranty for details.

## Monochrome laser printer

### High Yield cartridges produce up to 25,000 pages

Available High Yield cartridges produce up to 25,000 pages and never require shaking, which minimizes interruptions and reduces cost per page. The Lexmark print system and Unison™ Toner ensure consistent print quality throughout the life of the cartridge to prevent wasted prints.

### User-friendly

The MS817n is simple to install, easy to use and offers full compatibility with nearly every operating system and network, so you'll be up and running in minutes. It's built to last, so you'll easily be able to print up to 50,000 pages per month, thanks to our state-of-the-art paper handling technology and long-life consumables.

Lexmark's Mobile Print app for iOS and Android devices provides a simple and consistent user experience for printing from mobile devices. It features simple printer discovery and mobile print options.

A front USB port lets you print PDF and other image files directly from a flash drive and store scanned documents.



### Eco-friendly

The instant warm-up fuser saves energy and delivers the first printed page as fast as 4.8 seconds. Select an energy-saving mode (Quiet, Hibernate or Eco) to automatically minimize noise and energy consumption.

Through the Lexmark Cartridge Collection Program, Lexmark offers a free and easy way to return your empty cartridges for sustainable recycling or remanufacturing.



Product specifications		Lexmark MS817n
<b>Printing</b>		
Display	2.4-inch (6 cm) color LCD display	
Print Speed: Up to <sup>3</sup>	Black: 55 ppm	
Time to First Page: As fast as	Black: 4.8 seconds	
Print Resolution	Black: 600 x 600 dpi, 2400 Image Quality, 1200 x 1200 dpi, 1200 Image Quality	
Memory / Processor	Standard: 512 MB / Maximum: 2560 MB / Dual Core, 800 MHz	
Hard Disk	Option available	
Recommended Monthly Page Volume <sup>7</sup>	3000 - 50000 pages	
Maximum Monthly Duty Cycle: Up to <sup>5</sup>	250000 pages per month	
<b>Supplies<sup>2</sup></b>		
Laser Cartridge Yields (up to) <sup>1</sup>	11,000-page Cartridge, 25,000-page High Yield Cartridge	
Imaging Unit Estimated Yield: Up to <sup>4</sup>	100000 pages, based on 3 average letter/A4-size pages per print job and ~ 5% coverage	
Cartridge(s) Shipping with Product <sup>1</sup>	10,000-page Starter Return Program Toner Cartridge	
<b>Paper Handling</b>		
Included Paper Handling	550-Sheet Output Bin, 100-Sheet Multipurpose Feeder, 550-Sheet Input	
Optional Paper Handling	Output Expander, High Capacity Output Expander, Staple Punch Finisher, Staple Finisher, 4-Bin Mailbox, 550-Sheet Lockable Tray, 250-Sheet Lockable Tray, 2100-Sheet Tray, 550-Sheet Tray, 250-Sheet Tray	
Paper Input Capacity: Up to	Standard: 650 pages 20 lb or 75 gsm bond / Maximum: 4400 pages 20 lb or 75 gsm bond	
Paper Output Capacity: Up to	Standard: 550 pages 20 lb or 75 gsm bond / Maximum: 2550 pages 20 lb or 75 gsm bond	
Media Types Supported	Refer to the Card Stock & Label Guide., Transparencies, Plain Paper, Paper Labels, Integrated Labels, Envelopes, Dual Web Labels, Card Stock	
Media Sizes Supported	A6, Oficio, Universal, Statement, Letter, Legal, JIS-B5, Folio, Executive, DL Envelope, C5 Envelope, B5 Envelope, A5, A4, 9 Envelope, 7 3/4 Envelope, 10 Envelope	
<b>General Information<sup>6</sup></b>		
Standard Ports	Front USB 2.0 Specification Hi-Speed Certified port (Type A), Gigabit Ethernet (10/100/1000), USB 2.0 Specification Hi-Speed Certified (Type B), One Internal Card Slot	
Optional Network Ports / Optional Local Ports	Internal MarkNet N8350 802.11b/g/n Wireless / Internal 1284-B Bidirectional Parallel, Internal RS-232C serial	
Noise Level: Operating	Print: 56 dBA	
Specified Operating Environment	Altitude: 0 - 2896 Meters (9,500 Feet), Humidity: 8 to 80% Relative Humidity, Temperature: 16 to 32°C (60 to 90°F)	
Limited Warranty - See Statement of Limited Warranty	1-Year Exchange or Onsite Service, Next Business Day	
Size (in. - H x W x D) / Weight (lb.)	16.5 x 16.7 x 20.1 in. / 52.2 lb.	

<sup>1</sup>Average standard page yield value declared in accordance with ISO/IEC 19752. <sup>2</sup>Product functions only with replacement cartridges designed for use in a specific geographical region. See [www.lexmark.com/regions](http://www.lexmark.com/regions) for more details. <sup>3</sup>Print and copy speeds measured in accordance with ISO/IEC 24734 and ISO/IEC 24735 respectively (ESAT). For more information see: [www.lexmark.com/ISOspeeds](http://www.lexmark.com/ISOspeeds). <sup>4</sup>Actual Yield may vary based on other factors such as device speed, paper size and feed orientation, toner coverage, tray source, percentage of black-only printing and average print job complexity. <sup>5</sup>"Maximum Monthly Duty Cycle" is defined as the maximum number of pages a device could deliver in a month using a multishift operation. This metric provides a comparison of robustness in relation to other Lexmark printers and MFPs. <sup>6</sup>Printers are sold subject to certain license/agreement conditions. See [www.lexmark.com/printerlicense](http://www.lexmark.com/printerlicense) for details. <sup>7</sup>"Recommended Monthly Page Volume" is a range of pages that helps customers evaluate Lexmark's product offerings based on the average number of pages customers plan to print on the device each month. Lexmark recommends that the number of pages per month be within the stated range for optimum device performance, based on factors including: supplies replacement intervals, paper loading intervals, speed, and typical customer usage.

Monochrome laser printer

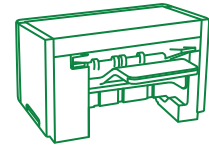
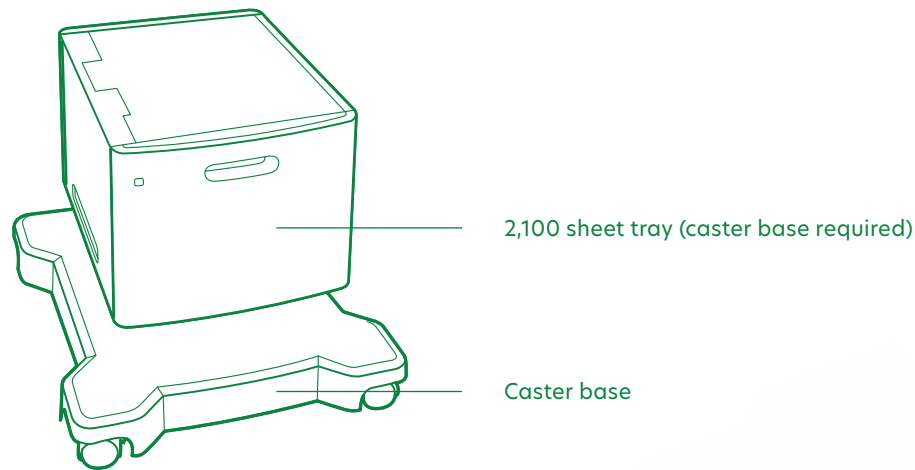
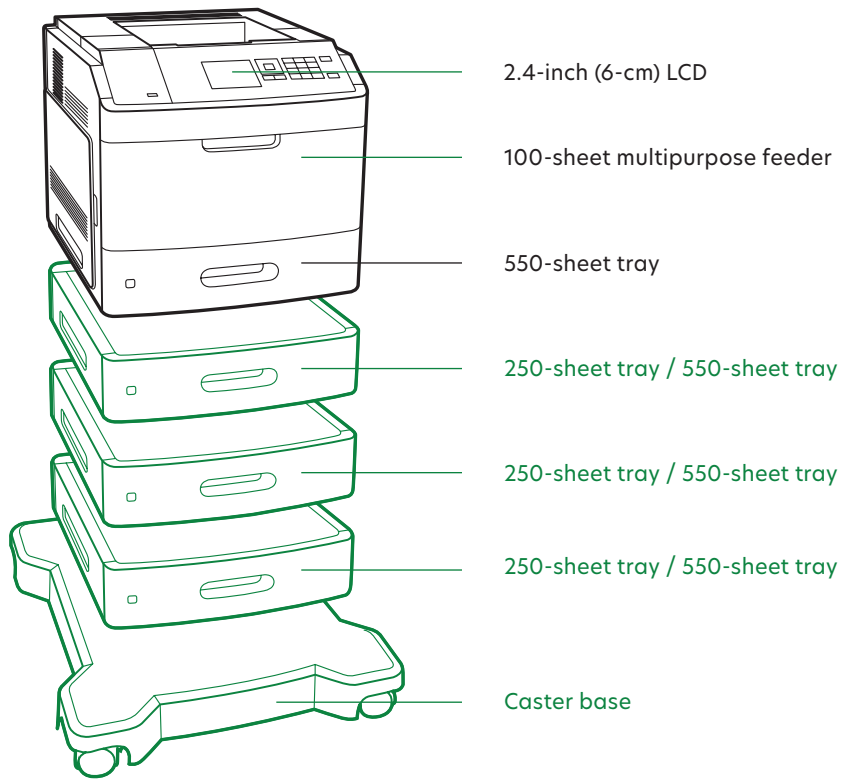

Staple finisher

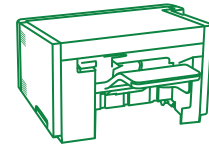

Staple, hole punch finisher

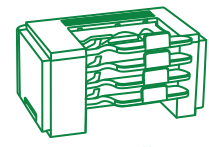

4-Bin mailbox

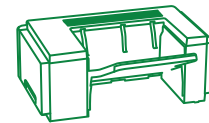

Output expander

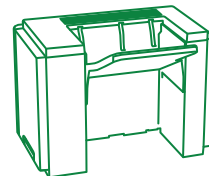

High capacity output expander

Standard  
 Optional