

SPECIFICATION : 500W LED Submersible Light

Part NO : INUI-SUB-500W



Customer	Approved	Checked	Prepared

INUI-SUB500W LED light has low light failure and more than 50000 hours of long life, higher than metal halide lamps or halogen lamp brightness and lower power consumption.

Features :

- 1. Use world-renowned Meanwell Or Inventronics Power Supply;**
- 2. Energy saved up to 50%, high brightness, even lighting output**
- 3. 10-years life time**
- 4. Input voltage: AC90-295V, Products require standard working voltage and exceeding prohibited; red for live wire, blue for null wire and yellow for earth wire.**
- 5. Instant start, no humming**
- 6. One Lamp 5-degree For Choose,Cover Longer Distance or Bigger Area.**
- 6. Special circuit design, each group of LEDs work separately, avoiding any problem of lighting output caused or influenced by single faulty LED**
- 7. No electrical wave, conforming to CE**
- 8. Green environmental protection, lead-free material, conforming to ROHS**

Applications:

Under water inspections, Working lights for under water, Sea platform inspections etc etc.

It is only used under water;

MAIN SPECIFICATIONS:

NO.	ITEM	DESCRIPTION
1	Input Voltage	90-295VAC/180-528VAC/DC12V/DC24V Optional
2	LED Power	500W
3	Replace the energy saving light power	2500W
4	LED type	USA CREE COB
5	Material	POM + Acrylic glass
6	Colour	Green/White/Blue/ multi Colour optional
7	Luminous Flux	Green: 45,000lm ; White: 80,000lm; Blue: 50,000lm;
8	Luminous Efficacy	100LM-160LM/W
9	View Angle	360°
10	Beam Angle	10/25/40/60/90Degree optional (Long Distance or Big Area)
11	Operating environment	Temperature : -40°C —60°C, 1-100 meters underwater
12	Life time	More than 50,000h
13	IP Code	IP68
14	IK Code	IK01
15	Luminaires Class	Class I
16	Weight	16kg(With cables); 12KG(Without Cables)
17	Size	(height)360mm (diameter)210mm
18	Remark	This specification is for reference, we can make it to your request

Product dimension:

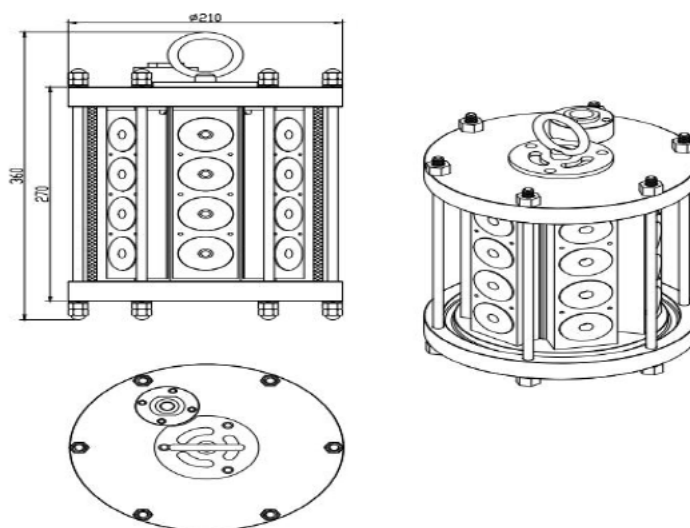

Packaging

Quantity :

1pcs/CTN 1

G.W:18KGS/CTN

Safety Notice for Using:

1. Before starting use of the light, please check if the light was damaged during transportation, if any damage shown, please do not install or use it.
2. Any maintenance should be performed by trained professionals only.
3. Keep packaging material away from the reach of children and pets. Risk of suffocation!

Caution! The packaging contains small parts that may be swallowed by children.

4. Never leave children unattended in the vicinity of the lights and do not allow them to play with electrical devices.
5. Try to avoid looking directly in the LED beam-especially for extended periods of time. Do not shine the LED light in another person's eyes.
6. Never cover the lights by other objects as this will inhibit the heat dispensation.
7. Never allow the light to come into contact with open flames or external heat sources.

Maintenance:

1. Prior to cleaning the light, make sure it has been disconnected from the power supply.
2. Use a dry or slightly moistened cloth for cleaning. Never use any chemicals or abrasives for cleaning.
3. Because of the acrylic glass using quality materials, the compressive anti-corrosion, but do not contact with alcohol.

Installation:

1. This product should be installed by trained electricians or competent person.
2. Check integrability of the products when unpack the packing.
3. Products with flammable materials to ensure that at least 0.2 m distance, pay attention to the low voltage and high voltage wire separate line.
4. Guide the lights connecting cables through the drilled-out hole, and fix the surface-mounted lights with the pre-fitted clips. Make sure that these are securely connected to the base material.
5. When laying the cables, make sure that the cables and plugs are not subjected to any tensile or twisting forces. Fit the cable tension relieving mechanisms to the connection points of the surface-mounted lights. Do not kink cables. Output cables should be laid separately and at a distance from other cables.
6. After installation, connect the transform to the mains supply.

Notes:

Non-professional are not authorised to disassemble and maintain the products. We have the right not to provide after-sale service if unauthorised disassembly and maintenance happens to the products.