

INUI Adjustable High Bay







INUI-ADJ-HBAY SERIES

The new HIGH-BAY series is highbay light which features exceptional efficiency, modern design and installation flexibility. Developed with INUI's latest generation of solid-state lighting and electronic driver technologies, the HIGH-BAY series stands above the competition by offering highly efficient Spike and Cooling Fin construction, maximising performance and improving overall energy savings. Perfect for warehouse, factory and other commercial buildings.

INUI





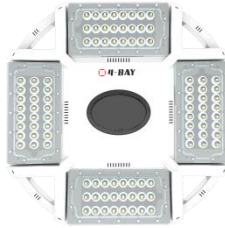

- 
PHILIPS
LUMILEDS
- 
Private
mode
- 
Dimmable
- 
Adjustable

ADJ-HBAY-100W

14,000LM
192PCS LED
4.3kg±5%





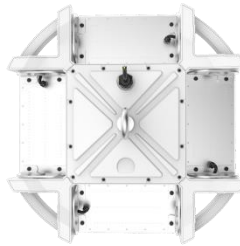

- 
PHILIPS
LUMILEDS
- 
Private
mode
- 
Dimmable
- 
Adjustable

ADJ-HBAY-150W

21,000LM
288PCS LED
4.3kg±5%







- 
PHILIPS
LUMILEDS
- 
Private
mode
- 
Dimmable
- 
Adjustable

ADJ-HBAY-200W

28,000LM
384PCS LED
5.1kg±5%



- 
PHILIPS
LUMILEDS
- 
Private
mode
- 
Dimmable
- 
Adjustable

ADJ-HBAY-240W

33,600LM
480PCS LED
5.1kg±5%

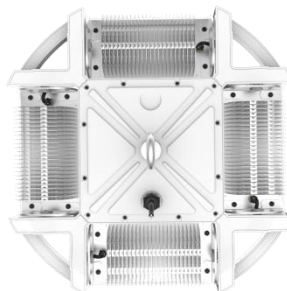

Performance

➤ Wattage	100/150/200/240W
➤ Light Source	LUXEON Lumileds
➤ Driver	Meanwell
➤ Lamp Luminous Flux	140LM ± 5%
➤ CRI	Ra>70/80
➤ CCT	2700-6500K
➤ Rated Voltage	AC 90-277V 50/60Hz
➤ Power Factor	>0.95
➤ Beam Angle	30°/60°/120°
➤ Heat Sink	Aluminum Cooling Fin / Aluminum Rivet
➤ Operating Temp	-40°C ~ 60°C

Application

The ADJ-HBAY Series is designed to be one of the most versatile luminaires to date. Offering multiple mounting options and with beam angles have 30°, 60°, 120°, application for the ADJ-HBAY Series is truly exceptional in all environments.

- Sports
- Airport
- Hospital
- Workshop
- Warehouse
- Shopping Centres
- Indoor Activity



Two Cooling Way

- Aluminum Spike
- Aluminum Cooling Fin



Module Adjustable

- Toolless light direction adjustment
- 16 tick-tock, 200° rotatable

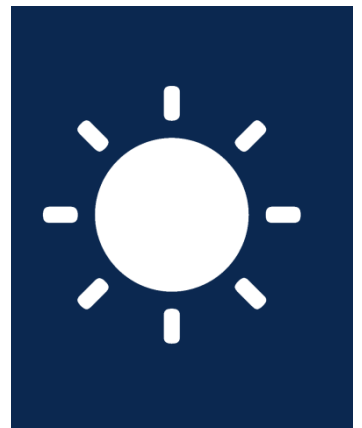
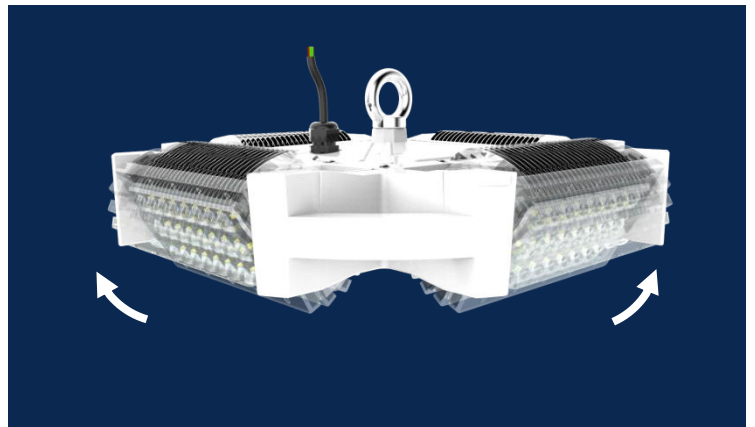

Ultralight

- Whole light 4.3 / 5.1Kg
- Lower freight cost

High Luminous Flux

- 140lm/W system efficiency
- Save 30% energy



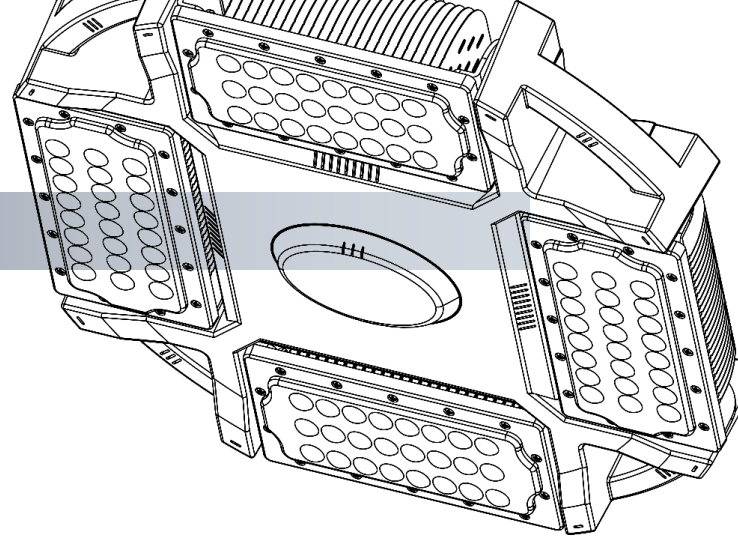

Professional Light Distribution

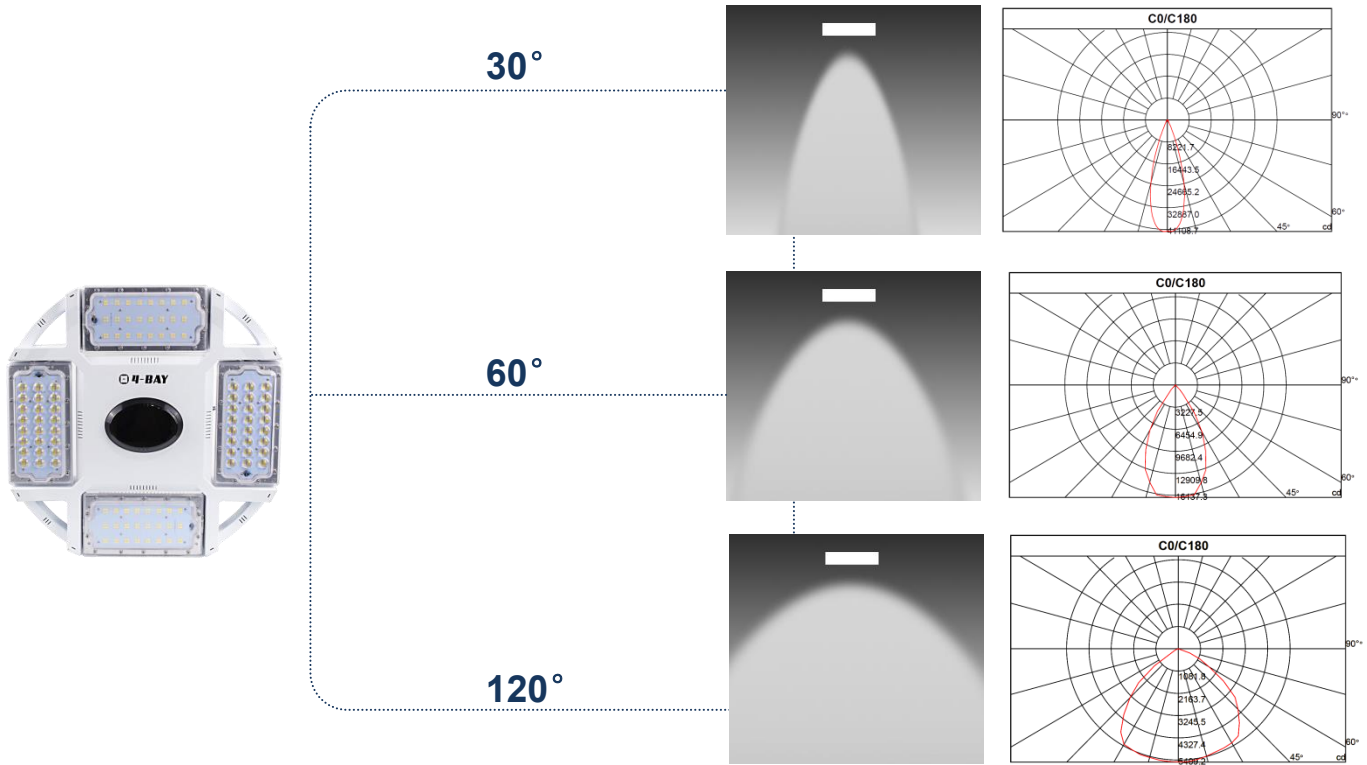

Installation

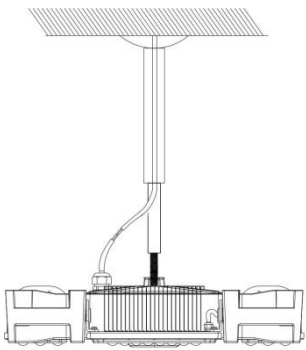

Optional accessories 1
Extension aluminum pipe

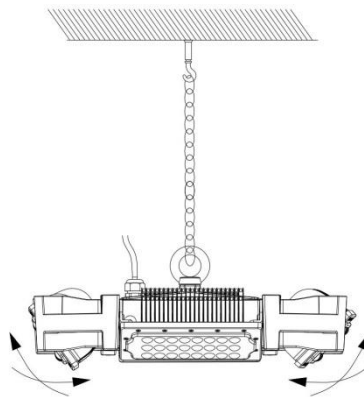

Optional accessories 2
Iron chain

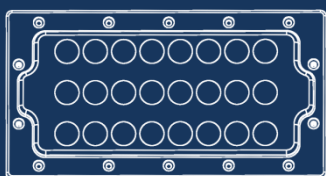

Lens

- Imitation diamond surface design
- Light transmittance as high as 92%

Construction

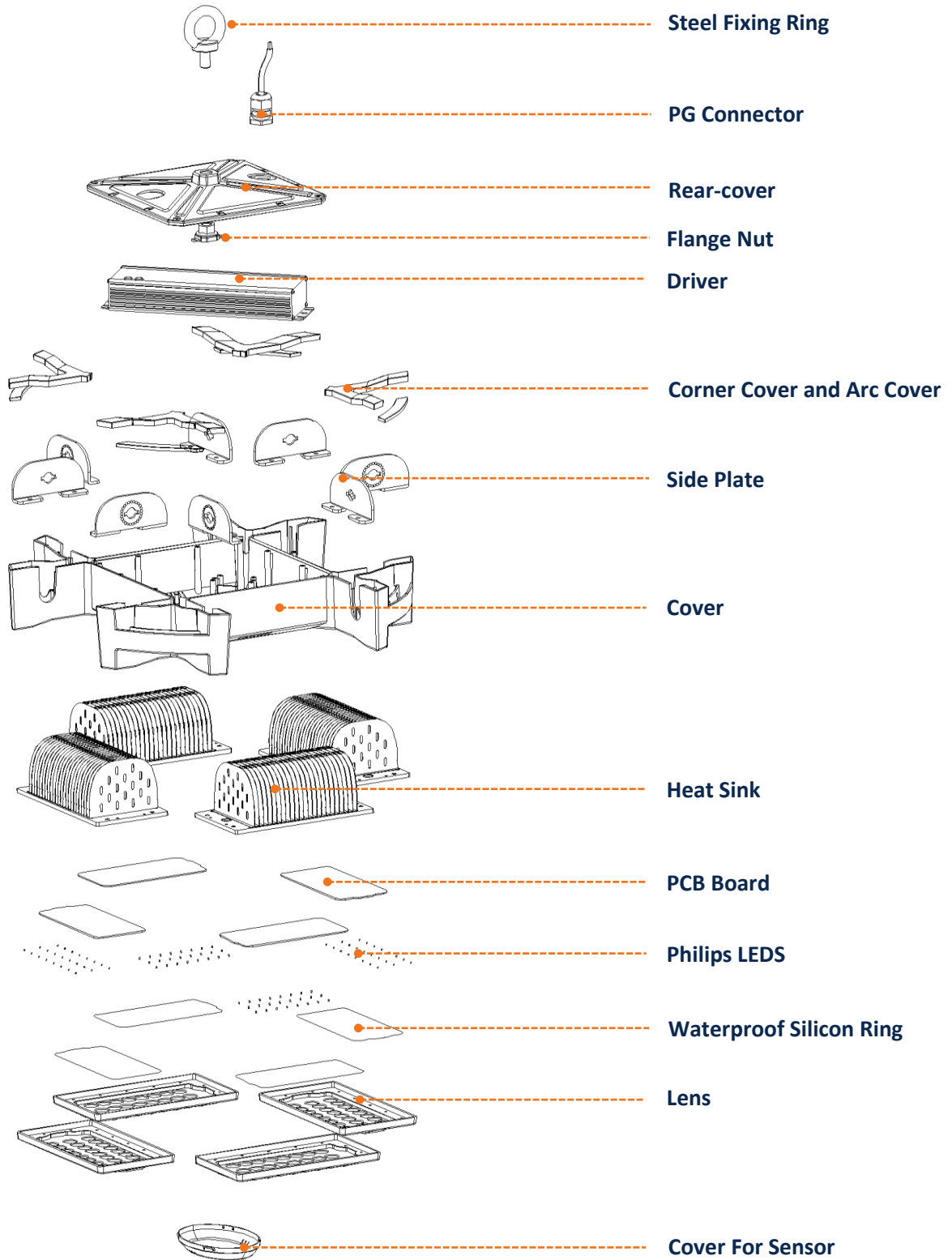

Temperature rise test (CO-4BAY-150W)

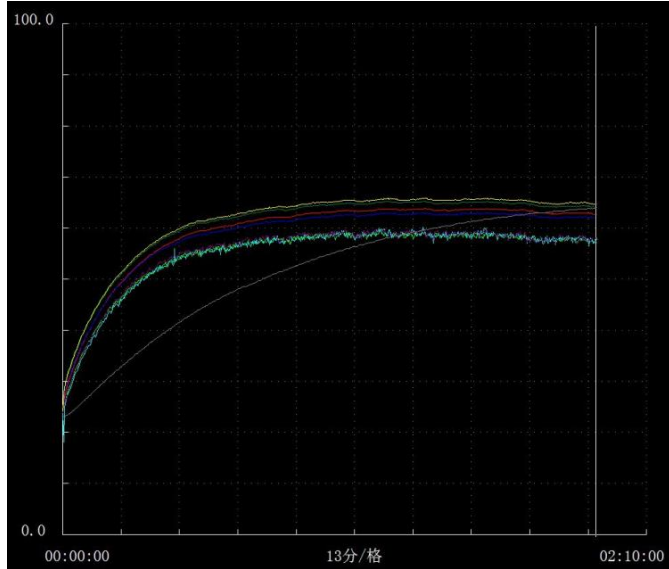
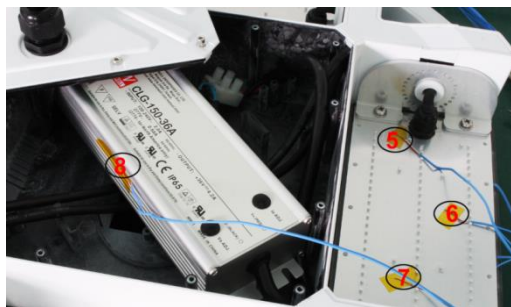
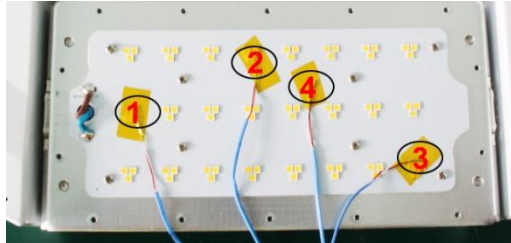

Test Point	Time(min)	00:00:00	00:30:00	01:00:00	01:30:00	02:00:00	02:30:00
CH1 LED		24.2	59.4	63.2	63.8	62.6	62.6
CH2 LED		24.2	61	64.6	65	63.9	63.9
CH3 LED		24.1	58.7	62.3	63.1	61.8	61.8
CH4 PCB Board		24.1	61.4	65.1	65.8	64.6	64.6
CH5 Heat sink		24	55.8	59	58.3	56.1	56.1
CH6 Heat sink		24.1	55.3	59.3	58.4	57	57
CH7 Heat sink		24	55.9	59.1	59.1	56.5	56.5
CH8 LED Driver		23.2	43.8	55.1	61.2	64.1	64.1

System test report (ADJ-HBAY-240W 6000K)

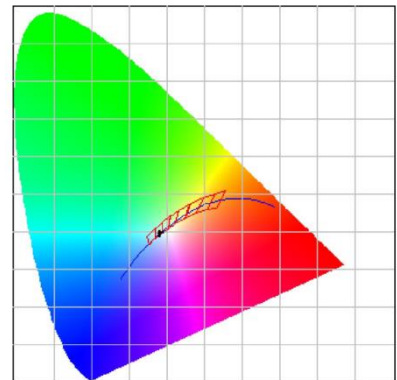
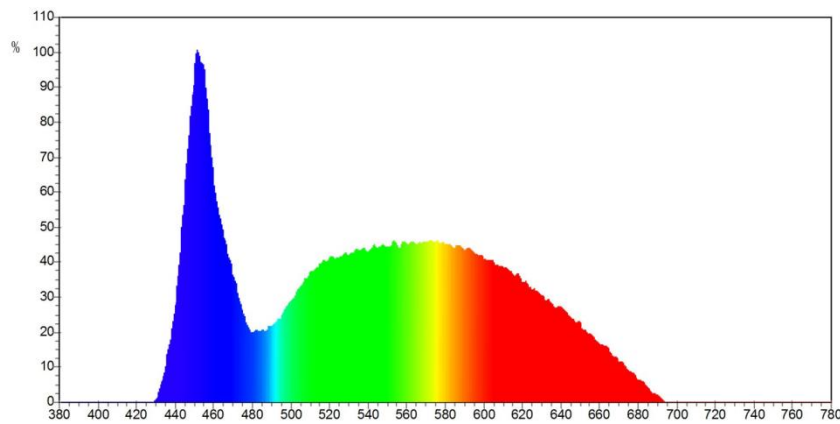

Electrical parameters

Flux: 34331.997 lm

P: 140.936 lm/w

P: 32604.68 mw

I: 1125.0 mA

V: 220.30 V

P: 243.600 w

PF: 0.9790

High-Low Temperature Testing

The Test equipment opening 2hours, keeping temperature -40°C, the lamp working fine.
 The Test equipment opening 4hours, keeping temperature >math>60^{\circ}\text{C}</math>, the lamp keep working fine.

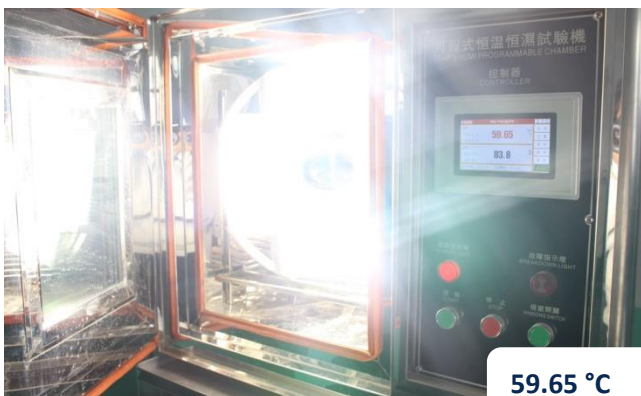
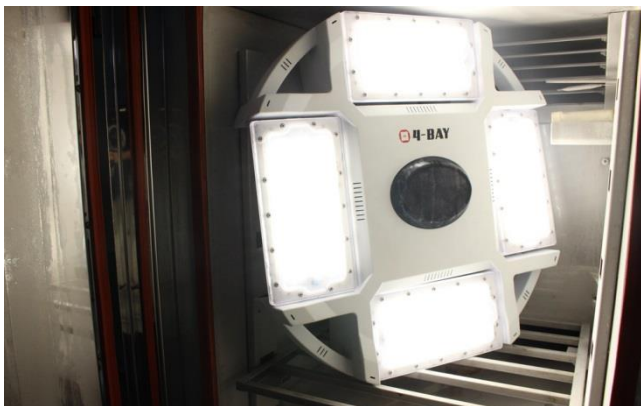

Salt Spray Test

The heat sink processed by electrical surging so that it has good corrosion resistance.

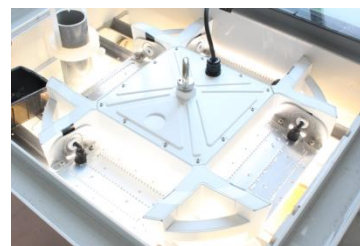

Uv Aging Test

The test time is about 1440 hours. After test the lamp working regularly , no discoloration appearance , no yellowing of the pc lens , no rust of the support



Dimension

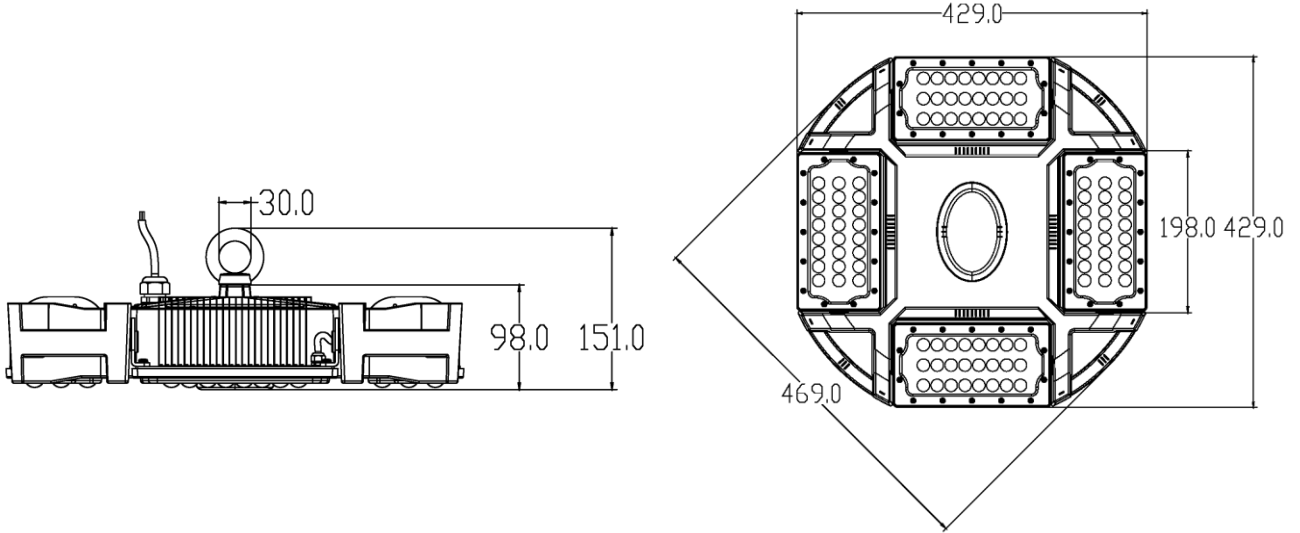

Packing

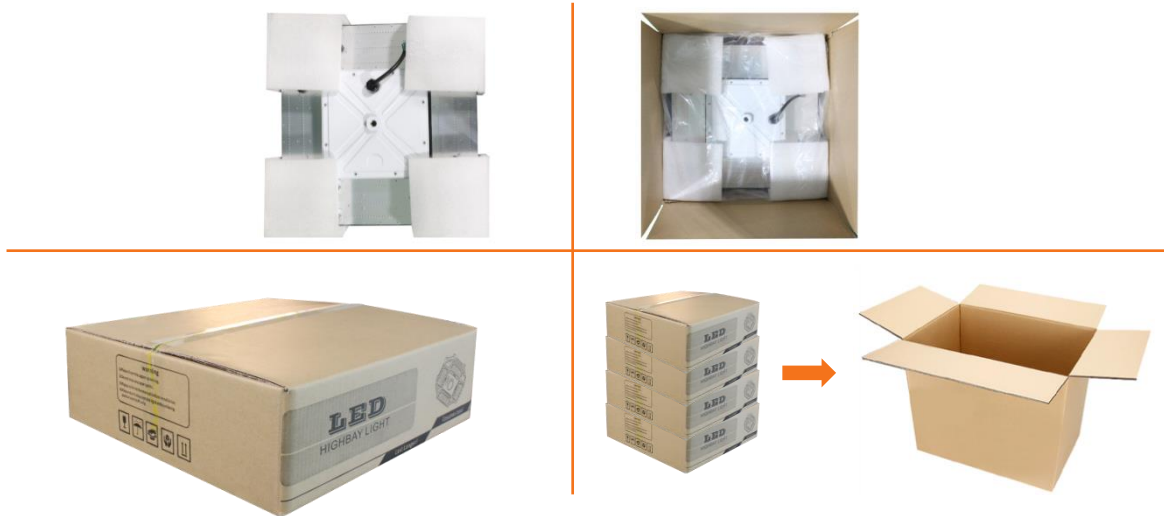

Model	Size of Box	Weight of Box	Size of Carton	Gross Weight of Carton	Box PCS /Carton
ADJ-HBAY-100W	47*46*15cm	5.3KG	50*49*66cm	22.7KG	4
ADJ-HBAY-150W	47*46*15cm	5.3KG	50*49*66cm	22.7KG	4
ADJ-HBAY-200W	47*46*15cm	6.1KG	50*49*66cm	26.4KG	4
ADJ-HBAY-240W	47*46*15cm	6.1KG	50*49*66cm	26.5KG	4