

EN

STOVE USER MANUAL

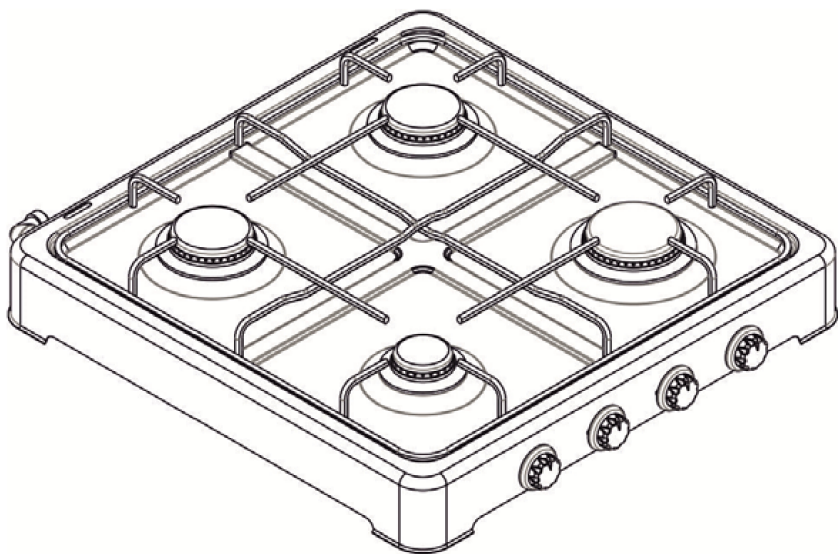

Please first read this manual!

Dear Customer,

We desire you take the most advantage of this product, which is produced in the modern facilities and subject to meticulous control procedures.

For this reason, please read the entire manual carefully before you use the product and keep the manual under hand for future reference. If you transfer the product to anybody else, give the manual together with it.

User manual help you use the product quickly and reliably.

- Read the user manual before you install and operate the product.
- Definitely comply with the instructions on safety.
- Keep the user manual as easily accessible for future use when required.
- Read other documents given together with the product as well.

Remember this user manual may also apply to the other models.

Differences between the models are clearly indicated in the manual.

Symbols and Description:

The following symbols take place in the user manual:



- 1- Important information and useful hints on use
- 2- Warning against dangerous situations in terms of life and property
- 3- Warning against fire risk
- 4- Warning against hot surfaces

Table of Contents

1) <u>Your product</u>	3
✓ General Appearance	3
✓ Technical Specifications	4
2) <u>Important Safety Instructions</u>	4
✓ General Safety	4-5
✓ Safety for children	6
✓ Intended use	6-7
3) <u>Installation</u>	7
✓ Prior to use of the product	8
✓ Connections	8
✓ Gas connection	9
✓ Leakage control	9
✓ Waste of the product – Destruction of the packaging	9-10
✓ Future Transportation procedures	10
✓ Disposal of the old product	10
4) <u>Preliminary preparation</u>	10
✓ First use	10
✓ First cleaning	10
✓ Description of use of the stove	11
5) <u>Maintenance and cleaning</u>	12
✓ General information	12
✓ Cleaning of the control panel	12

1) Your Product

GENERAL APPEARANCE

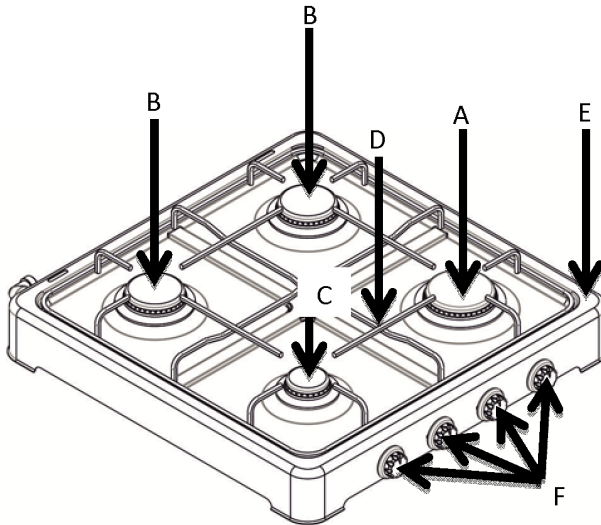



- A. Strong burner
- B. Normal burner
- C. Auxiliary burner
- D. Upper grill
- E. Body
- F. Control switch

Technical Specifications

TECHNICAL SPECIFICATIONS OF THE PRODUCT									
Specifications	G30 30mbar Injector	Single Stove	Dual Stove	Triple Stove	Quartet Stove	Quartet Stove	Quartet Stove	Quartet Stove	Quartet Stove
Gas Category	13B/P	13B/P	13B/P	13B/P	13B/P	13B/P	13B/P	13B/P	13B/P
Strong burner	Ø 0.65	1.85 KW	1.85 KW	1.85 KW	1.85 KW	1.85 KW	1.85 KW	1.85 KW	1.85 KW
Normal burner	Ø 0.60		1.50 KW	1.50 KW	2x1.50KW	2x1.50KW	2x1.50KW	2x1.50KW	2x1.50KW
Auxiliary Burner	Ø 0.50			1 KW	1 KW	1 KW	1 KW	1 KW	1 KW

 Your stove is designed to operate by G30 29mbar (LPG) gas. It is not possible to convert the stove to operate by different gases.

 Use 1.5 kg/300mm SS Pressure-reducing valve on your stove as per TSE standards.

 This product is designed to operate outdoors only.

 Technical specifications may be changed without prior advice in order to improve product quality.

 Figures given in the manual are schematic and they may not exactly match with your product.







 The declared values on the markings of the products or in other printed documents provided together with the product are values obtained in laboratory as per the respective standards. These values may vary depending on the use and environment of the product.

2) Important safety instructions

This section contains safety instructions that may help prevent risks of personal injury or property damage. If you fail to observe these instructions, the warranty will become invalid.

General Safety

- This product is not designed by any handicapped people, mentally, physically and sensually or by any people having no knowledge and experience (including children) unless they are attended by a person that may assume their safety or give directions for use of it. The children will be supervised and they will never be allowed playing with the product.

- If venturies of your stove becomes clogged due to food overflow, contact with the authorized service center and have the eye of the stove unclogged.
- If the product is damaged or has any visible defect, do not operate the product.
- Do not perform any repair or modification on the product.
- Do not use the product when your discernment is impaired due to taking drugs and/or alcohol.
- Always call authorized service center for installation and repair operations. The manufacturing company may not be kept responsible for any damage that may arise as a result of operations by unauthorized persons and the warranty will become invalid as a result of it.
-  Be careful when using alcohol in your food. Alcohol evaporates at high temperature and when it comes into contact with hot surfaces, it blazes up and cause fire risk.
-  Do not heat the closed tin cans and glass jars. Pressure to develop may cause burst of the jar.
 Do not bring flammable materials near when the product operates because its sides may be hot.
-  This equipment should be kept away from the flammable materials.
-  The product may get hot when operating. Do not touch the hot departments, inner parts and heating parts of the furnace.
-  The product and its parts accessible by hand are hot when using.
-  The product may be hot after use of it. If you have to touch it, wear heat-resistant gloves.
- Do not move the stove when using it.
- Keep all ventilation channels unobstructed around them.
- After each use of the product, make sure the pressure-reducing valve is closed.
- Do not use sharp and piercing materials to clean inside and glass of the product; such materials may give damage to your product.

- As hot oil may cause fire risk, always be alert when the product operates.
- In case of any possible fire, do not attempt to extinguish the fire with water; immediately cut off the power connection of the product and cover the burning part by help of a wet blanket.
- Do not use steam cleaning agent.
- Do not product the product any nylon, flammable and any materials not resistant to a temperature of 100°C.
- Pans to be placed on the furnace heaters should be in proper sizes.
- When you feel gas smell (leakage, close the pressure-reducing valve immediately.



Safety for children

During and after operation of the product, the exposed parts of the product will remain hot until it gets cool; keep the children away from it.

- CAUTION: During operation of the grill, the accessible parts may be hot. Keep small children away from it.
- It is risky that children below 8 years old to contact with the product when they are not attended by an adult person.
- This product may be used by the children above 8 years old and/or by any physically, sensually or mentally handicapped people if they are informed about the risks and proper operation of the product is shown to them.
- Children should not play with the product. Cleaning and maintenance of the product may not be performed by the children not supervised by the adult people.
- Packaging materials may be risky for the children. Keep them at such places out of reach of the children and sort them out according to the waste instructions and dispose them.

Intended use

This product is designed for outdoor use. It is not allowed for commercial use. “CAUTION: This product may be used only for cooking. It should not be used to heat the room or any other purpose.”

The manufacturer may not be held responsible for any damage that may occur as result of improper use or during handling. Service life of the product you have purchased is 10 years. This is the period during which the manufacturer will make available the replacement parts if the product is used as specified.

3) Installation

Prior to use of the product

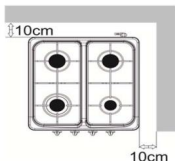

- Install your stove in the sizes shown in the figure.
- Make sure the vents are open.
- Make sure the place where you install the stove is made of heat-resistant material. Do not place it on plastic and similar materials

f Make sure the gas installation is proper.

f Preparation of the installation place as well as gas installation is for responsibility of the product.

A The rules set forth in the applicable local standards regarding gas should be observed during installation of the product.

A Damaged products may pose danger for your safety.

A Any operation on the gas equipment and systems should be performed by authorized and competent persons.

The product is not equipped with a system for evacuation of the gases that may form after combustion. The product should be installed and connected as per the applicable installation regulations. Requirements related to ventilation should be specially observed.

Connections



Property damage!

Do not use the cover, gas hose and/or gas control switches to carry or move the product.

Gas connection



Any operation on the gas equipment and systems should be performed by authorized and competent persons.

Prior to installation, make sure the local distribution conditions (gas type and gas pressure) are compliant with the settings of the product.

LPG connection

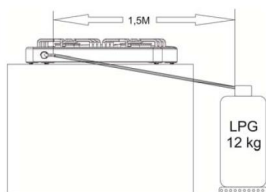

- Be careful that gas hose and gas-reducing valve you will use for the stove should be reliable. Fix the gas supply hose to the hose nozzle behind the stove and tighten with a hose clamp and screwdriver (Figure 6). Make sure it is tightened well.
- Length of the gas hose of the stove should not be longer than 1500mm.
- Pressure of the gas-reducing valve to be used for LPG should be 1.5 kg/300mmSS and duly certificated.
- Hoses old, cracked, softened, hardened and used more than 2 years should be replaced.
- Hoses for connecting the containers to the equipment should comply with TS1846 standard and should be made of such material as not to be affected by gas.
- Use your stove with 12 kg gas container.

⚠ Gas supply hose should not pass through the hot part at the rear of the stove. Temperature of the gas hose should not exceed 90°C.

Make sure the system does not leak gas prior to use of it.



Figure 6

Leakage control

Open the gas-reducing valve and control with highly foamed soap water for any gas leakage on the connection you have made.

⚠ Never control it with flame.

Final control

- 1- Make sure the installation of your stove is proper.
- 2- Control the functions.

Disposal of the product



Destruction of the packaging

Packaging materials are dangerous for the children. Keep the packaging materials at a place out of reach of the children.

Packaging of the product is produced by recyclable materials. Sort them out according to the waste instructions and dispose. Do not throw them together with the domestic waste.

Future handling operations

- Keep the original cartoon of the product and carry the product inside this box. Comply with the instructions given on the cartoon. If its original cartoon is not available, wrap it by use of bubble packaging material or a thick cardboard and band it tightly.
- Band and fix the heads and pan supports tightly.

- Do not use the cover or handle to carry or move the product.
-  Do not put any article on the product. The product should be carried upright.
-  Control the product visually against any damage that may have occurred during the handling.

Disposal of the old product

 Use the old product in such a way not to give any damage to the environment. The product has a symbol (WEEE) on it, indicating that electric and electronic equipment waste should be collected separately.

You should comply with the Directive 2002/96/EC in order to recycle or divide into part for minimization of its possible effect on the environment. For further details please apply to the local or regional authorities.

Electronic products not subject to the controlled collection operation would constitute potential risk for both environment and human health due to the harmful materials they contain.

You may contact your dealer or the garbage collection department of the municipality.

Prior to disposal of the product, cut the power cable and break the cover lock in order to prevent any risk against the children.

4) Preliminary Preparation

First use

Make sure the requirements set forth in the manual have been fulfilled.

First cleaning

 Some detergents or cleaning agents may give damage to the surface.

1. Remove all packaging materials.
2. Wipe clean the surface of the product with a damp cloth or sponge and then wipe it dry with a cloth.

Description of the use of the stove

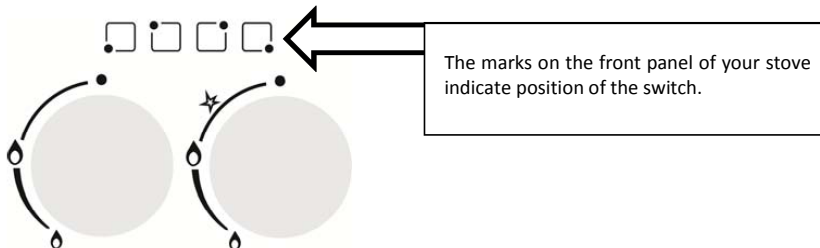

- 1: Push and turn anticlockwise the gas stove switch to bring to high flame.
- 2: Ignite the lighter according to the characteristic of your stove.
- 3: Bring it to the desired flame position.
- 4: When the cooking is over, turn the switch clockwise to the high point to cut off the burner.

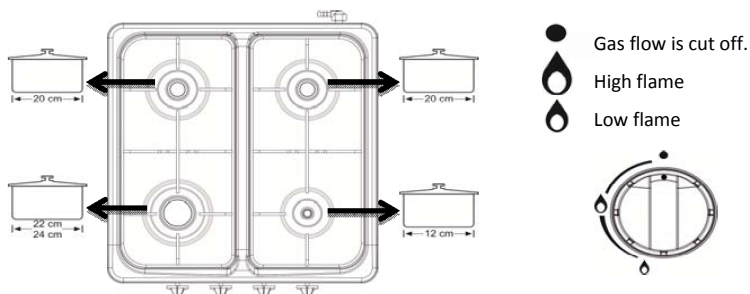

Size of the container and size of the gas flame should exactly comply with each other. Adjust the gas flame in such a way that it will exceed the base of the container. Put the container on the centre of the pan supporter.

5) Maintenance and cleaning

General information

If the product is regularly cleaned, its service time will be extended and frequently encountered problems will be reduced.



Hot surfaces may cause burns!

Allow the product to cool down before you clean the product.

- The product should be cleaned thoroughly after each use. Thus the food deposits are easily cleaned off and thus such deposits are prevented from burning in the subsequent use of the product.
- No special cleaning agent is required to clean the product. Clean the product with the washing liquid, lukewarm water and soft cloth or sponge and wipe it dry.
- Make sure that no liquids left after the cleaning process and you immediately clean any splash of food during the cooking.
- Do not use any cleaning agent containing acid or chlorine to clean the stainless or inox surfaces and handle. Clean by wiping in one direction by help of soft cloth soapy and liquid (no-scratch) detergent.



Some detergents or cleaning agents may give damage to the surface. Do not use aggressive detergents, cleaning powder/cream or sharp objects.

 Do not use steam cleaning products for cleaning purpose.

Cleaning of the control panel

Clean the control panel and control buttons with a damp cloth and wipe it with a dry cloth.

 Control panel may be damaged! Do not remove the control switch to clean the control panel.

