

EN

VITROCERAMIC HOBS

USER MANUAL

30-60-80-90 CM

INTRODUCTION

Please first read this manual carefully!





Dear customer,

Thank you for your choosing our product. We wish our quality product manufactured with advanced technology may provide best efficiency. As it is, we kindly ask you to read this manual carefully and keep it handy for reference. If you hand over the product to another user, please give it together with its usage manual. Follow the instructions given in the usage manual, taking into consideration all information and warnings as well.

This manual may apply for more than one version. Differences among the versions are detailed in the manual.

Symbols and Descriptions

This user manual contains the following symbols.

	Important information and useful tips for use
	Warning against life and property risks
	Warnings against electric shocks
	Warning against fire risk
	Warning against hot surfaces

MANUFACTURING FIRM

MAMUR TEKNOLOJİ SİSTEMLERİ A.Ş

Selimpaşa San. Bölgesi Merkez Mah. 5008 Sok. No:11 Silivri/İstanbul

Tel: 0 212 723 48 80

TABLE OF CONTENTS

1.	SAFETY AND ENVIRONMENTAL DIRECTIVES	3
1.1.	General Safety	3
1.2.	Electric Safety	3
1.3.	Product Safety	4
1.3.1.	Combustion Safety	4
1.3.2.	Intended Use	5
1.4.	Safety for Children	5
1.5.	Compliance with AEEE Regulation and Disposal of Waste Product	5
1.6.	Packaging Information	5
2.	HOB INSTALLATION	6
2.1.	Correct Place for Installation	6
2.2.	Installation and Connections	7
2.3.	Electric Connection	7
2.4.	Product assembly	8
2.4.1.	Choice of Furniture and Installation	8
2.4.2.	Ventilation	9
2.4.3.	Installation of the Hob	10
2.4.4.	Removal of the Hob	10
2.5.	Energy Saving	10
2.6.	First Use	10
3.	ABOUT PRODUCT	11
3.1.	General Characteristics	11
3.2.	Technical Characteristics	12
4.	USE OF HOB	13
4.1.	General Information About Hob	13
4.1.1.	Selection of Pans	13
4.2.	Use of the Hob	14
4.3.	Control Panel	14
4.3.1.	Starting the Heating Process	15
4.3.2.	Switching the Equipment Off	15
4.3.3.	Selection and Cooking of the Cooking Section	15
4.3.4.	Stopping the Heating Process	15
4.3.5.	Child / Key Lock	16
4.3.6.	Timer Function	16
4.3.7.	Stop and Continue Function	16
4.3.8.	Selection of Expedited Section	16
4.4.	Quick Power Setting	17
4.5.	Heat Sensing on the Vitroceramic Cookers	17
4.6.	Limitation of the Operating Durations	17
4.7.	OverHeating Protection	17
4.8.	Overflowing Detection	17
4.9.	Cooking Recommendations	18
5.	MAINTENANCE AND CLEANING	19
5.1.	General	19
5.2.	Cleaning the Hob	19

1. SAFETY AND ENVIRONMENTAL DIRECTIVES

This chapter contains safety instructions to help prevent any injury, crash or material damage involved with the product. Failure to comply with these instructions shall make all guarantees invalid.

1.1. General Safety

This equipment may be used by children 8 years old and above and by people with reduced physical, sensory or mental capabilities or people lack of experience and knowledge provided they are attended or provided with instructions for safety use of equipment. Children should not play with the equipment. Cleaning and maintenance by user should not be performed by children unattended.

Always get support from Authorized Service Center for installation and repair. Production may not be held responsible for any damages that may arise from operations performed by unauthorized persons

If product is visibly damaged, do not operate the product.

Remember to turn the product off after each usage. Make sure whether it is turned off or not.

This equipment is not designed for use by persons (including children) with reduced physical, sensory or mental capabilities or people lack of experience and knowledge unless they are under control or provided with instructions about use of the equipment.

Children should be supervised to make sure they do not play with the equipment.

If input voltage is damaged, it should be replaced by the manufacturer, authorized service agent or similar qualified persons in order to avoid occurrence of any risk.

WARNING: If there is any surface crack, turn the equipment off to prevent electric shock.

As metal objects such as knives, forks, spoons and lids may get heated, they should not put on the hob surface.

After using the hob, control and switch the hob department off and do not rely on the pan sensor.

The equipment is not designed to operate with external timer or a different remote control system.

WARNING: The equipment and its accessible parts get heated during use. Please be careful not to touch the heating elements. Little children under 8 years old should be kept away unless they are attended.

Instructions for hobs and clearance include:

WARNING: Cooking food with fat or liquid oil on a hob may become dangerous and cause fire. NEVER attempt to extinguish fire with water; only switch the equipment off and then cover flames with a lid or fire blanket.

CAUTION: Cooking process should be supervised. A short cooking process should be supervised continuously.

WARNING: Fire risk; do not put objects on the ceramic glass.

WARNING: Surface temperature exceeds 95°C. To avoid any risk, prevent access to the section under counter.

1.2. Electric Safety

Make sure the fuse rate on the power line and even on the line to which the product is connected to comply with the rates given in the product manual.

If the product is faulty, it should be repaired by the Authorized Service Center and should not be operated before it is repaired!

Connect the product to a grounded plug socket or line protected by a fuse having a rate given in the table of "Technical Specifications". If you use transformer or transformer filter, install a quality electric wiring for grounding system. When the product is used without grounding in compliance with the applicable local regulations, the manufacturer shall not be responsible for any resulting damages.

Never wash the product by spraying or pouring water on it! There is risk of electric shock!

Remove the plug from the wall socket during installation, maintenance, cleaning and repair. For products connected to the line directly, remove the fuse for electric safety of the line.

If the electric cable gets damaged, it should be replaced by an authorized service centre or a qualified electrician.

Product should be installed in such a way that it can be completely disconnected when required. Disconnection should be performed with a main switch or a fuse connected to the fixed electric wiring as per the building regulations.

All works to be performed with the electric equipment and systems should be performed by authorized and qualified persons.

Make sure the fuse current is compliant with the product current.

1.3. Product Safety

As the product is hot when the product is operating, do not touch the product or its exposed components. Children under 8 years old should not approach to the product when they are unattended.

People suffering from loss of consciousness or reasoning due to use of drugs and alcoholic drinks should not use the product.

Be careful when using alcohol for preparing the food. Alcohol evaporates at high temperature and, when exposed to hot surfaces, it may inflame and cause fire.

When the product operates, the product and its surroundings will be hot. Do not place any flammable substances around the product to avoid of fire risk.

Keep all ventilation conduits open.

Do not clean the product with vapour cleaning agents as they may cause electric fire.

Do not put materials on the hob for storage purpose.

In case of possible cracks on the product, disconnect the electric connection of the product to avoid electric shock.

After using the hob, turn the hob plate off from its own control and do not rely on the pan sensor.

As metal objects such as knives, forks, spoons and lids get heated, they should not place on hob plate.

The product which is categorized as cooking class is not proper for control by use of remote control and similar products

Vapour pressure caused by hob surface and moisture may cause shifting or hopping of the pan. For this reason, always be careful that pan base and hob surface should always be dry.

As the induction hob operates basing on the principle of cordless energy transfer and causes magnetic field, its use by people using medical equipment such as pace maker and insulin pump ay be harmful.

1.3.1. Combustion Safety

Make sure your product is safely connected to the socket or power line. Otherwise, electric arc may occur and cause fire risk.

Do not use cut or damaged mains power cable.

Make sure there is no liquid or damp at the location where the electric plug of the product is connected and fastened.

Leaving the hob unattended when cooking with fat or oil is dangerous as it may cause fire. NEVER attempt to extinguish the fire with water. Disconnect the power connection of the product and cover it with something flame resistant.

1.3.2. Intended Use

This product is designed for domestic use. It is not suitable for commercial and industrial use.

This product should be used for cooking and should not be used for heating or similar purposes.

The manufacturer does not accept any responsibility for any damage that may occur as a result of improper use contrary to the instructions given in the manual and during transportation.

Service life of the product you purchased is 10 years. This is the duration during which the manufacturer will make replacement parts available for proper operation of this product as specified.

1.4. Safety for Children

Hob and its surroundings are hot during use of it. Keep the children away from the product and its surroundings.

Packaging materials are hazardous for children. Keep the packaging materials out of reach of the children.

As electric products involve risk of electric shock, keep the children away from the product and its surroundings.

Do not put any object on the product to which children may have access.

1.5. Compliance with AEEE Regulation and Disposal of Waste Product



This product does not contain any hazardous and forbidden substances according to the "AEEE Regulation Regarding Control of Waste Electric and Electronic Goods" published by the Ministry of Environment and Urban Planning".



This product is made of recyclable and reusable high quality parts and materials. As it is, please send this product to a gathering point for recycling of the electric and electronic equipment at the end of its service life.



1.6. Packaging Information

Packaging of the product is made of recyclable material as per the National Regulations. Do not throw away the packaging waste together with domestic waste and deliver them to the packaging gathering points designated by the local authorities.

	Technical specifications are subject to change without prior notice in order to improve product quality.
	Figures in the manual are schematic and may not match with your product.
	Values declared on the markings on the product itself or on other printed documents given together with the product are values obtained under the laboratory conditions as per the applicable standards. These values may vary depending on the use and ambient conditions.

2. HOB INSTALLATION

Please contact with the nearest Authorized Service Center for installation of your product. Prior to contacting with the Authorized Service Centre, make sure you have the required electric wiring. Otherwise, an authorized electrician shall make necessary arrangements. The Manufacturer may not be held responsible for any damages arising from unauthorized operations and in such case the product guarantee shall become invalid.

	Customer shall be responsible for installation site as well as preparation of the electric wiring.
	WARNING: Installation of the product should comply with the rules given in the local electric standards.
	WARNING: Make sure the product is not damaged prior to installation of the product. If the product is damaged, do not install the product. Damaged products are dangerous for your safety.

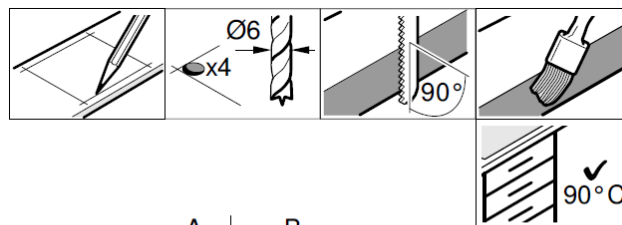

A	B
490	min. 60
480	min. 50

C = min. 40

2.1. Correct Place for Installation

Product is designed to mount on the standard kitchen counters. Kitchen walls, kitchen furniture and hob clearance are important both for safety and for performance of the product. Technical drawings are for minimum distances recommended. All values are given in mm.

If hood/aspirator shall be installed above your equipment, please comply with the recommendations of the hood/exhaust fan manufacturer (i.e. min. 65 cm.)

Remove the product out of its box prior to loading. Remove transportation locks and packaging materials. Surfaces, laminates, adhesives and other materials at the installation location should be resistant against minimum 100°C.

Kitchen counter should be horizontally flat and firm.

Gap where the hob shall be installed on the counter should be cut according to the installation dimensions of the hob.

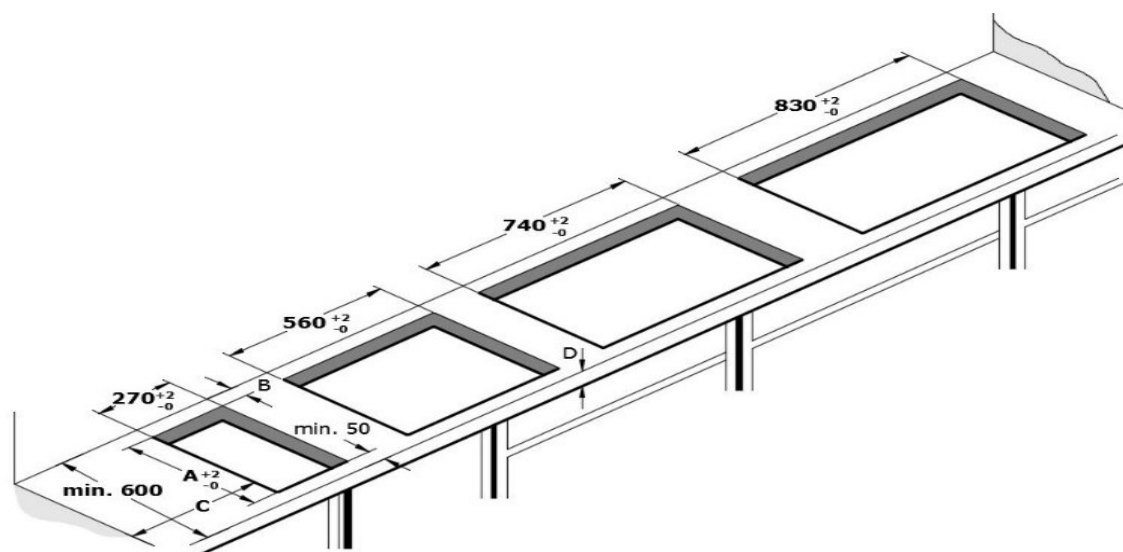



2.2. Installation and Connections

Product should be installed and operated in accordance with the local regulations.

	Do not place the heater at the sharp corners and edges. Vitreous ceramic surface has a risk of breaking!
---	--

2.3. Electric Connection

Connect the product to a grounded cable or line protected by a fuse according to the table of Technical Specifications. The manufacturer cannot be held responsible for any damages when used without grounding in accordance with the applicable regulations.

	WARNING Connection of the product to the mains may be carried out only by an authorized person and product guarantee only starts upon correct installation.
	WARNING Power cable should not be crushed,, pressed or contact with hot ports of the product. In case of damaged electric wiring, necessary replacement should be performed by an authorized electrician.

Connection cable of the product can be supplied by our company as indicated in the chapter of Technical Specifications. Mains voltage should comply with 220-240 VAC as indicated in the table of Technical Specifications and product nameplate.

<i>Wiring for Hobs 30 cm</i>		<i>Wiring for Hobs 60-80-90 cm</i>	
Brown Cable:	L (Phase)	Brown – Black Cable:	L1(Brown) - L2(Black) (Phase)
Blue Cable:	N (Neutral)	Blue-Grey Cable:	N (Neutral)
Green/Yellow Cable:	E (Grounding)	Green/Yellow Cable:	E (Grounding)

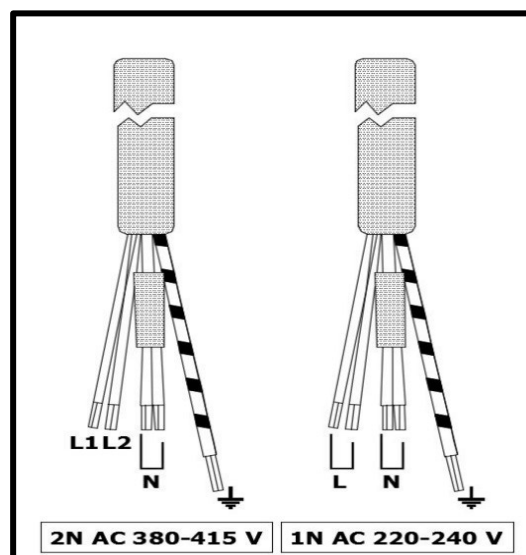
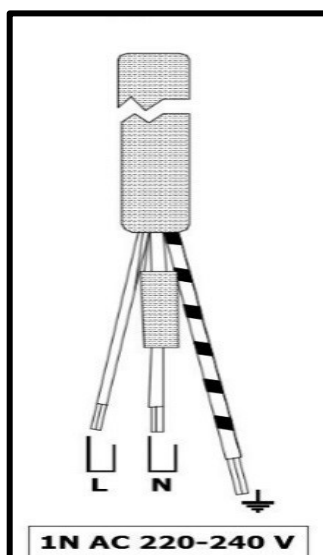

2.4. Product assembly



Unplug the product from the socket prior to starting any operation with the electric wiring. There is a risk of electric shock.

Cooker to be mounted inside the hob should be resistant against load of 60kg approximately.
After installation, make sure the hob is parallel to the floor.

2.4.1. Choice of Furniture and Installation

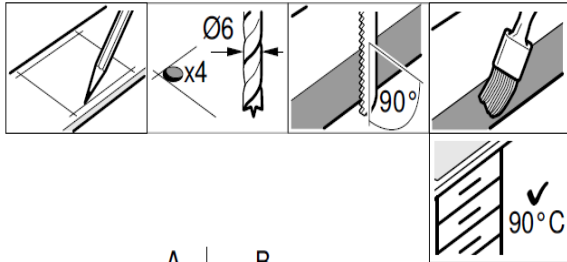

Stationary furniture should be resistant against minimum temperature of 90 °C.

After the furniture is cut, clean the sawdust.

Cover the surfaces cut out with a heat resistant material.

A	B
490	min. 60
480	min. 50

C = min. 40

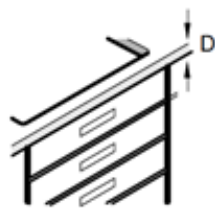

When it is mounted to the drawers, counter thickness should be minimum 20 mm.

min. 20

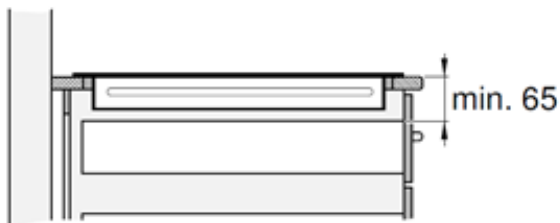

When it is mounted to a drawer, distance between the working table and top part of the drawer should be minimum 65mm.

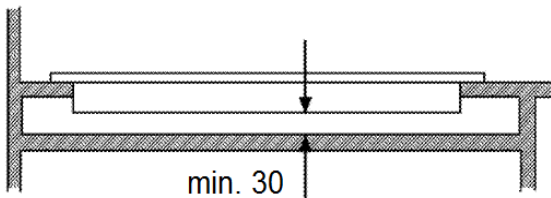

In case it is mounted to a drawer, a piece of wood may also be used to prevent contact of the user with the bottom of the hob.

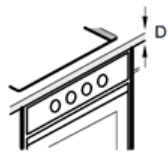

In case of installation on the hob, the thickness of the counter should be minimum 30 mm.

min. 30

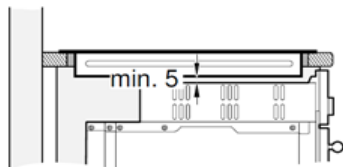

Distance between the hob and oven should be minimum 5 mm.

2.4.2. Ventilation

Your cooker which is heated by induction requires ventilation for superior performance.

Hob should be ventilated well for proper operation of the equipment.

Furniture should be positioned according to the technical drawing in order that the area under the equipment should sufficient air.

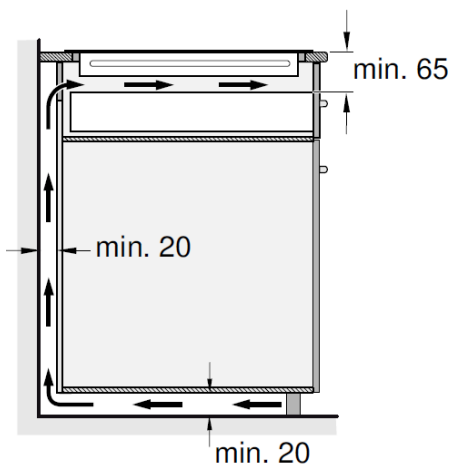

Minimum distance between the furniture and kitchen wall and counter and drawer:

Clearance behind the furniture:

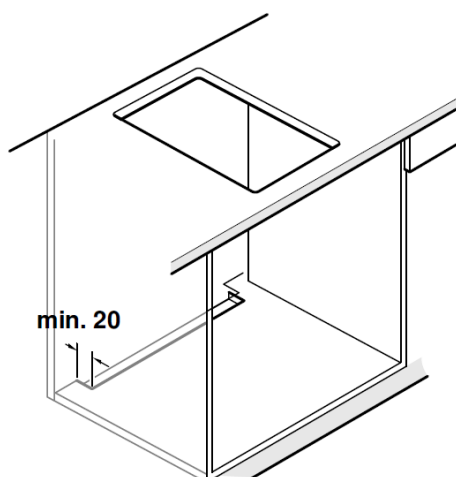
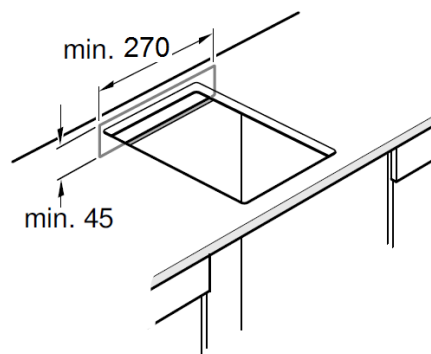

If there is no place for clearance of 20mm behind the furniture, then a hole should be drilled in the bottom.

If the equipment will be installed at a location not designated, then proper ventilation should be provided.

2.4.3. Installation of the Hob

When installing the hob, use a pair of protective gloves against any invisible sharp edges.

When mounting the equipment, use the apparatus given with the equipment.

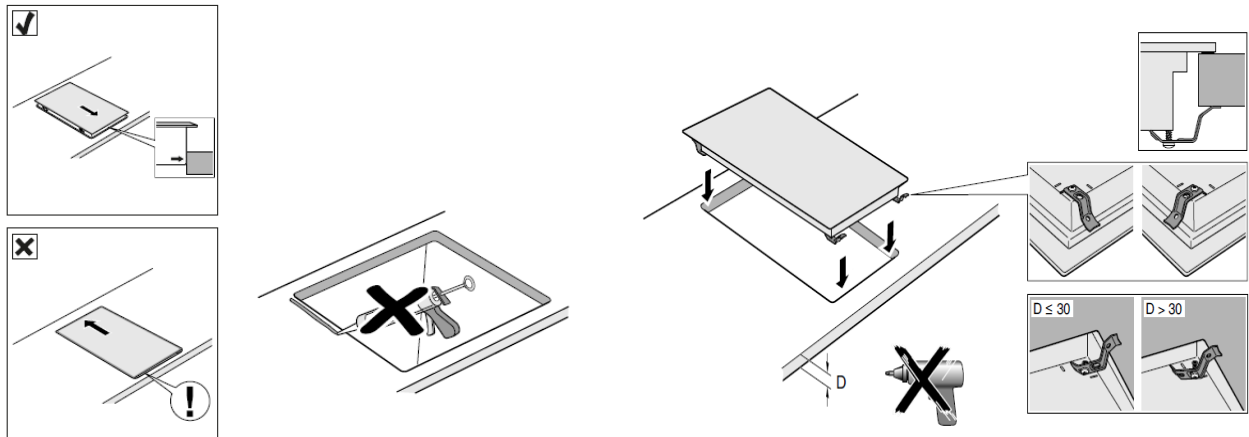

Make sure that power cable is not stuck.

Watch the sharp edges and connect the power cable to the socket at the rear of the hob.

When installing the power cable, be careful not to touch the hot surfaces.

2.4.4. Removal of the Hob

Disconnect the equipment from the mains.

Remove the connections.

Remove the equipment by applying pressure from below.

2.5. Energy Saving

For energy saving, it would be useful to apply the following things to your product.

- Frozen food should be thawed before cooking.
- Pans and pans should be preferred for cooking.
- Size of the container used should be suitable for the cooking surface of the hob. The bigger the pan size is, the bigger the energy consumption is.
- Hob surface and pan bases should be clean and dry. Dirt and moisture makes it hard to heat the pan.

2.6. First Use

Remove all packaging and packaging items.

Wipe glass surface of the product with a wet or damp cloth and wipe clean it with a cloth prior to use.

3. ABOUT PRODUCT

3.1. General Characteristics

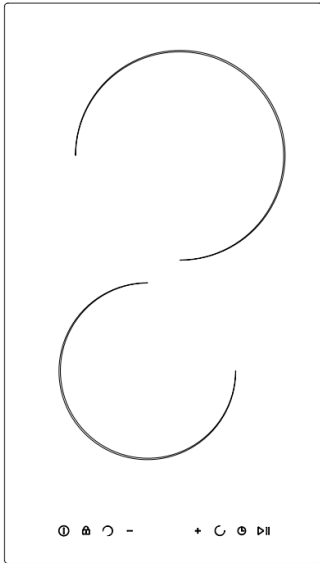

MS**(EA30-012C)

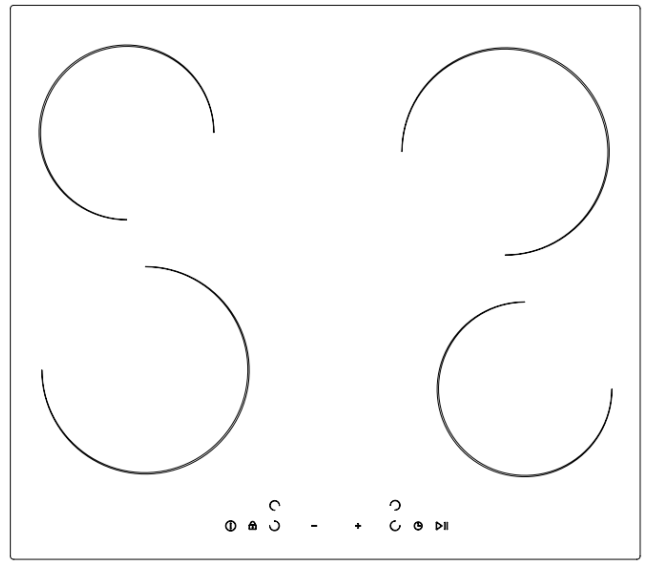

MS**(EA60-014C)

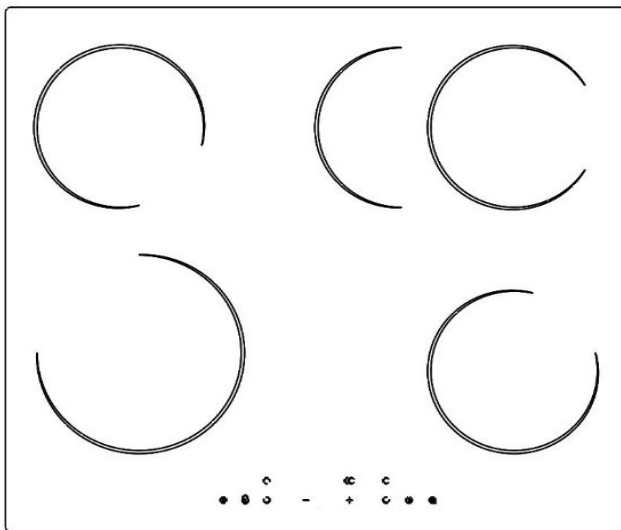

MS**(EA60-014C)

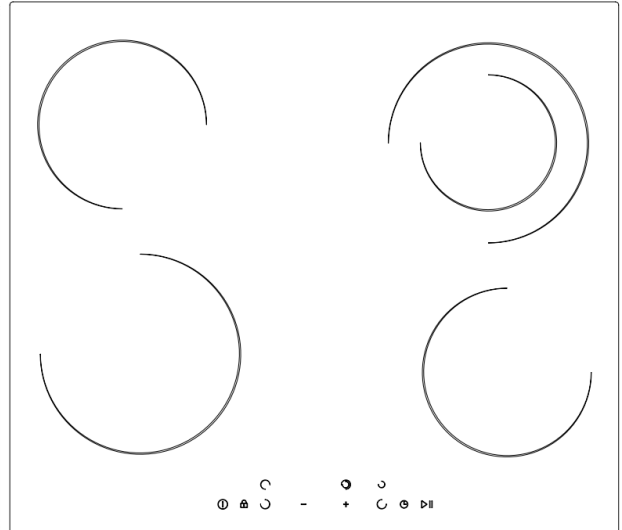

MS**(EA60-014C)

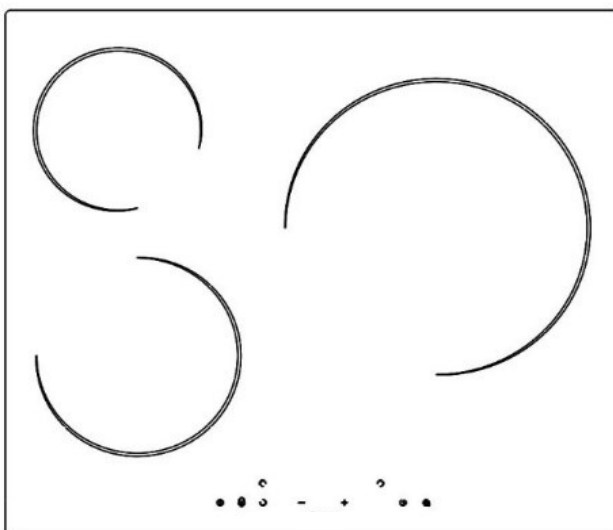

MS**(EA60-013C)

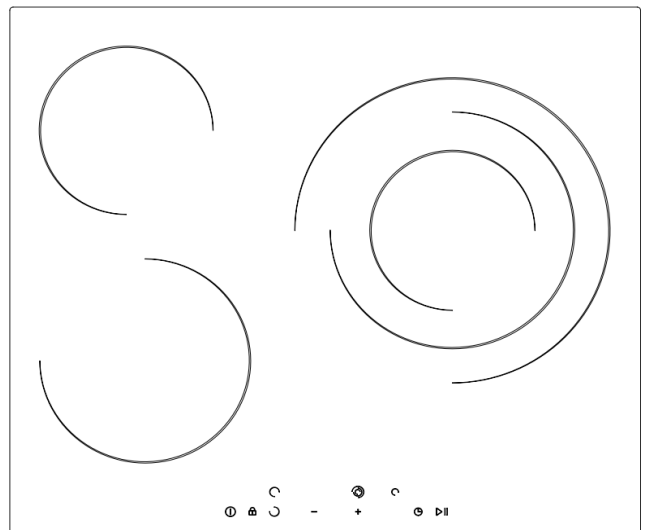

MS**(EA60-013C)

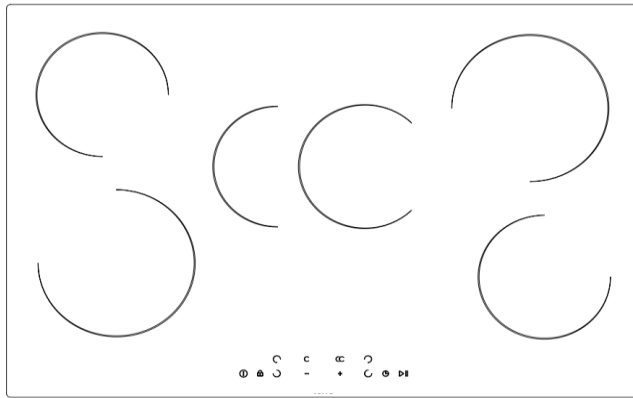

MS***(EA80-015C)

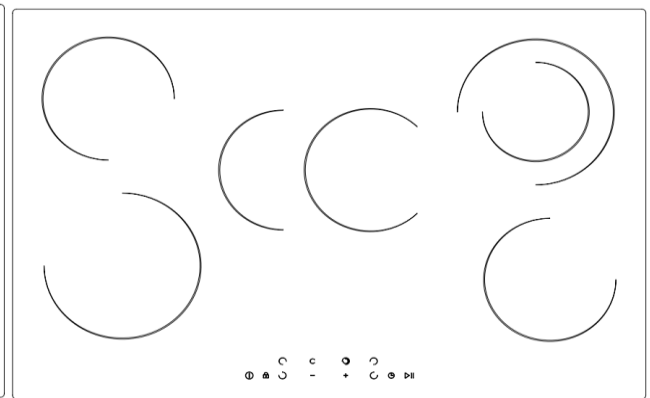

MS***(EA80-015C)

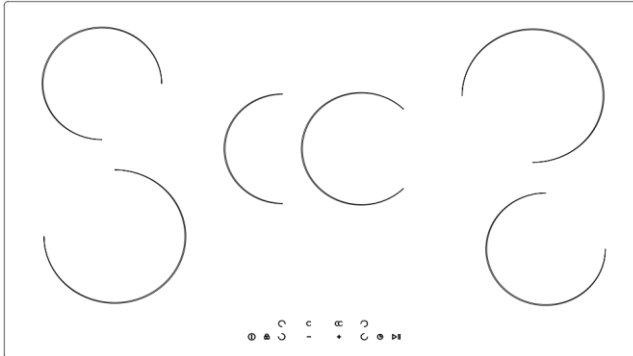

MS***(EA90-015C)

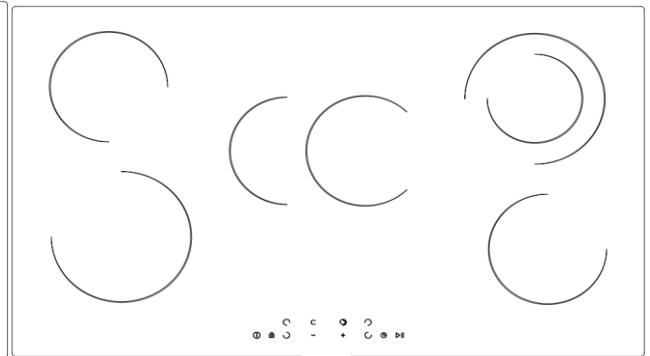

MS***(EA90-015C)

3.2. Technical Characteristics

S.No.	Heating Power (W)	Heater Diameter (mm)	MS131	MS161	MS162	MS163	MS164	MS165	MS181	MS182	MS191	MS192
1	1200W	145	1	2	2	2	1	1	2	2	2	2
2	1800W	180	1	2	1	1	1	1	2	2	2	2
3	1700W / 700W	180 / 145				1						
4	2000W / 1100W	245 / 140			1				1	1	1	1
5	2600W	300					1					
6	2700W / 1950W / 1050W	270 / 210 / 140						1				

Version	Size	Exterior Size (mm) WidthxLengthxHeight	Number of Heaters	Voltage	Frequency	Power	Fuse to be Used	Cable Type/Section	Cable Length
MS131	30	510x290x45	2	220-240V	50-60 Hz	3 kW	16Ax1	H05V2V2 - F 3x1.5mm ²	max. 2 meters
MS161	60	510x580x45	4	220-240 V / 380-415 V(2 PHASE)	50-60 Hz	6 kW	16Ax2	H05V2V2 - F 5x1.5mm ²	max. 2 meters
MS162	60	510x580x45	4	220-240 V / 380-415 V(2 PHASE)	50-60 Hz	6.2 kW	16Ax2	H05V2V2 - F 5x1.5mm ²	max. 2 meters
MS163	60	510x580x45	4	220-240 V / 380-415 V(2 PHASE)	50-60 Hz	6 kW	16Ax2	H05V2V2 - F 5x1.5mm ²	max. 2 meters
MS164	60	510x580x45	3	220-240 V / 380-415 V(2 PHASE)	50-60 Hz	5.6 kW	16Ax2	H05V2V2 - F 5x1.5mm ²	max. 2 meters
MS165	60	510x580x45	3	220-240 V / 380-415 V(2 PHASE)	50-60 Hz	5.7 kW	16Ax2	H05V2V2 - F 5x1.5mm ²	max. 2 meters
MS181	80	510x770x45	5	220-240 V / 380-415 V(2 PHASE)	50-60 Hz	6.8 kW	16Ax2	H05V2V2 - F 5x1.5mm ²	max. 2 meters
MS182	80	510x770x45	5	220-240 V / 380-415 V(2 PHASE)	50-60 Hz	6.8 kW	16Ax2	H05V2V2 - F 5x1.5mm ²	max. 2 meters
MS191	90	510x860x45	5	220-240 V / 380-415 V(2 PHASE)	50-60 Hz	6.8 kW	16Ax2	H05V2V2 - F 5x1.5mm ²	max. 2 meters
MS192	90	510x860x45	5	220-240 V / 380-415 V(2 PHASE)	50-60 Hz	6.8 kW	16Ax2	H05V2V2 - F 5x1.5mm ²	max. 2 meters

4. USE OF HOB

4.1. General Information About Hob

	Never put oil in the oil more than one third of it. When super-heating the oils, never leave it unattended. Excessively heated oils pose fire risk. Never attempt to extinguish a possible fire with water. When oil bursts into flames, cover it with a fire blanket or a wet cloth. Switch the hob off if it is safe to do so and call the fire brigade.
---	--

Prior to frying the food, dry them completely and put them into the super-heated oil slowly. Prior to frying the frozen food, allow them to thaw.

Do not use unstable and easy to tip over containers on the hob.

Do not put containers and pans empty on the open hob plates. They may get damaged.

After each use, close the hob plates.

Put appropriate amount of food in the pans or pans. In this way, you will prevent overflowing of the food and you will not have to do the extra cleaning.

Position the pans in the centre of the hob plates.

4.1.1. Selection of Pans

Vitreous ceramic surface is resistant to heat and made of heat-resistant material.

Do not use the vitreous ceramic surface as a surface to put something or cut something on it.

Sharp pan and pan edges may scratch the surface. Use basic machined pan.

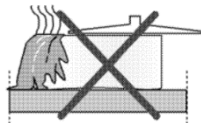

Food remnants may damage surface of the pan and cause fire.

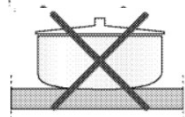

Do not use concave and convex based containers.

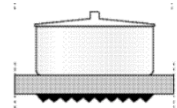

Use only pans or pans with flat base. They ensure easier heat transfer.

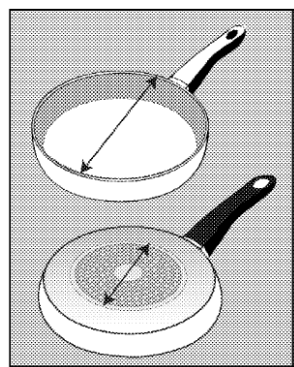



Even if diameter of some pans and pans is big, diameter of the base area that can be heated is smaller. In case of such pans, cooking performance may be low. For this reason, products with appropriate pan base should be preferred.

Important

When you will use non-sticking pan greased or covered with small amount of grease (Teflon type), do not select high heating levels.

Do not put metal objects such as forks, knives or pan lids on the hob as they get heated. Never use aluminum folio for cooking purpose. Never put food wrapped with aluminum folio on the plate of the induction hob.

	If there is hob under your hob and hob operates, the sensors on the hob may reduce the cooking level or deactivates the hob.
	When the hob operates, keep magnetic objects such as credit cards and cassettes away from the hob.

4.2. Use of the Hob



Do not allow falling of any object on the hob. Even small objects such as salt holders may give damage to the hob.

Do not use the cracked hobs. Water may leak through such cracks and cause electric short circuits. Cold may cause failure of the hob.





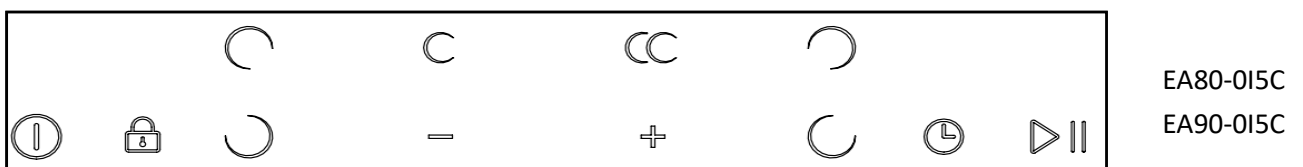
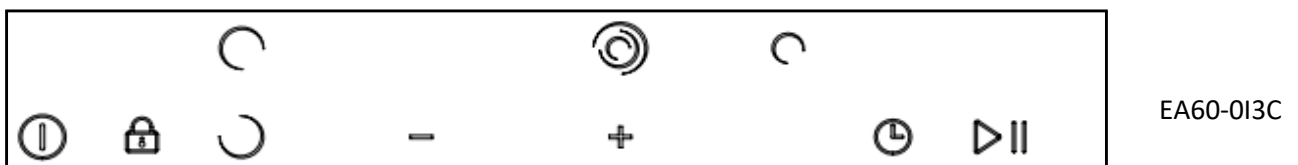
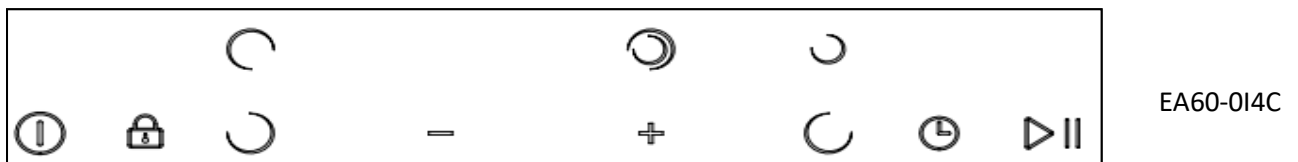

If surface has got damaged in any way, switch off the product immediately and disconnect the electric wiring.

4.3. Control Panel

Interfaces for the product versions are given below.

	Graphics and figures are given only as example. Actual image or functions may be different from the version of your hob.
	This product is controlled with touch control panel. Each action you perform on the touch control panel is communicated with an audible signal.
	Always keep the control panel clean and dry. Damp or dirty surface may cause failure of operation.

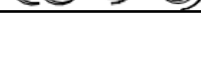

	On/Off
	Heating Modes
	Timer
	Power and Timer Value Increase
	Power and Timer Value Decrease
	Child /Key Lock
	Stop-Continue
	Expanded Section Modes

4.3.1. Starting the Heating Process

Press  on the control panel.

If heating level info is not entered in the heaters within 10 seconds after the hob is switched on, the hob is automatically switched off.

4.3.2. Switching the Equipment Off

Press  on the control panel.



If the letter "H" appears on the display after the hob is switched off, it means the hob is still hot. Do not touch the glass surface.





When the power is switch off, this warning system shall be deactivated.

4.3.3. Selection and Cooking of the Cooking Section



 Switch on by touching on-off button.

Press the selection key  or  to select the cooking area you want to open.

Press the buttons   to set the heating levels in the range of 1 and 9.

4.3.4. Stopping the Heating Process

= To close the selected cooking area, you may bring the heating level to "0".

If you keep press the selection button  or  of the plate in question, the heating level drops down to "0" and the hob plate in question is switch off.

 Switching off may also be performed by using on/off button on the control panel. However, in such case, it is not recommended to switch off all active heaters simultaneously.

4.3.5. Child / Key Lock



It is a function on the control panel for preventing use of the equipment by the children when the hob is off or operates.

Child/key lock activates when the key  on the control key is touched for a certain time. At this time, the inscription "Lo" appears on the display unit. And, additionally, child/key lock Led turns on. When the related function is activated, buttons except for on/off button do not operate.



Child/key lock becomes disabled when the key  on the control key is touched for a certain time. And the inscription "Lo" is deleted and related LED becomes off.



4.3.6. Timer Function

It is not required to attend at the hob during the cooking process. You enable the timer function of the selected plate and switch the related hob plate at the end of the set time.

After the heating plate is selected ,  ;

Press the button  on the control panel

button  or  determines operating time of the selected plate and then the timer is enabled by pressing the key 

	Always keep the control panel clean and dry. Damp or dirty surface may cause operational failures.
	Follow the steps described above for other works for which you want to set the timer.
	Timer does not operate before power level is selected on the hob.

At the end of the set time, hob is automatically switched off and an audio signal is given to inform the user that it is off.

In order to cancel the timer, first select the timer, and when the hob plate is selected, timer is reduced to "0". Thus, the timer function becomes disabled for that hob plate.



Another method to cancel the timer is to press the timer button for a short time after the hob plate to be used is selected.

4.3.7. Stop and Continue Function

This function is used to suspend operation of the hob. This button suspends all functions of the hob.

Touching  button on the control time for a certain time will enable the stop and continue function. Use the same button to disable the function.

4.3.8. Selection of Expanded Section

With some version, after the cooking selection, the expanded section is used by touching , 

or  .

4.4. Quick Power Setting

Power value determined by the user is reached quickly. There is no waiting or inertia. In this way, adversities such as overflowing or burning are prevented.

4.5. Heat Sensing on the Vitroceramic Cookers

Vitroceramic hobs are equipped with safety equipment. For vitroceramic hobs, heaters have temperature perception probes. When temperature of the heater goes above a certain value, energy of the heater is automatically cut off.

4.6. Limitation of the Operating Durations

All levels have a certain maximum operating duration. Hob is automatically switched off at the end of that duration.

Limit of the operating duration depends on the selected power level. Hob can be switched on after it is automatically switched off.

Operating Durations for Hobs



<i>Heating Level</i>	<i>Time/Hour</i>	<i>Switch-off Time (second)</i>	<i>Heating Time (second)</i>
1	6	45,6	1,4
2	6	43,6	3,4
3	5	41,3	5,7
4	5	38,4	8,6
5	4	35,9	11,1
6	1,5	33,1	13,9
7	1,5	26,2	20,8
8	1,5	19,2	27,8
9	1,5	0	47

4.7. OverHeating Protection

Excessive heating conditions are perceived by temperature sensor and necessary safety measures are taken.

4.8. Overflowing Detection

Your pan is a limitation system against overflowing. If there is liquid on the user control panel, system is automatically switched off.

	If surface of the touch control panel contacts with intense steam, the control system may be disabled and give an error signal.
	Keep surface of the touch control panel clean; otherwise some functions may not operate.

4.9. Cooking Recommendations

Figures given in the following table are indicative. Necessary heating settings for various cooking methods depend on a series of variables such as quality of the cooking equipment used, type and amount of the food being cooked, etc.

Recommended Settings for Cooking

<i>Cooking Levels</i>	<i>Cooking Method</i>	<i>Cooking Examples</i>	<i>Cooking Times (minute)</i>
2	Melting	Melting Bitter Chocolate	4
4		Melting Butter	7
4		Melting Gelatine	7
6*	Unfreezing – Boiling	Boiling Egg *	6
5		Boiling Rice	35
4		Cooking Frozen Spinach	35
4		Cooking Frozen Vegetable Garniture	35
9		Boiling Unpeeled Panato	37
8	Heating- sauté	Stew	40
5		Béchamel Sauce	25
6		Soup	32
9	Frying	Frying Frozen Panato	6
7		Nugget	13
7		Fish	6
6**	Cooking (Low oil))	Meat(3 cm Thickness)**	11
8**		Chicken (3 cm Thickness)**	22
5**		Fish Fillet**	12
6		Pressure Cooker Dishes	-
9	Boiling	Water	7
8		Milk	20
7*		Pasta	10



* Pre-heating is made for Water Boiling at level 9.

** Turn several times.

5. MAINTENANCE AND CLEANING

5.1. General



If the product is cleaned regularly, its service time of the product extends and common problems reduce.

	Disconnect power supply prior to performing maintenance and cleaning procedures. There is risk of electric shock!
	Allow the product to cool down prior to cleaning the product. Hot surfaces may cause burns.

Product should be thoroughly cleaned after each use. In this way, food remnants are easily cleaned and burning of such remnants is prevented when the product is used later on.

No special cleaning agent is required to clean the product. You clean the product with dishwashing detergent, lukewarm water and a soft cloth or sponge and wipe it clean with a dry cloth.

After the cleaning process, make sure that any remaining liquids were wiped off completely and any food scattered around during cooking were cleaned up.

	Some detergents or cleaning agents may give damage to the vitreous ceramic surface. Do not use aggressive detergent, cleaning powder, cleaning creams or sharp objects for cleaning.
	Do not steam cleaning agents for cleaning.

5.2. Cleaning the Hob

Vitreous ceramic surface should be cleaned with cold water; in this way no cleaning agents leave on the glass and the glass should be wiped clean with a soft cloth. Remnants may give damage to the vitreous ceramic surface during subsequent use of the hob.

Dry remnant on the glass ceramic surface should never be cleaned off by using instruments such as cloth, knife etc.

	Sugary food such as concentrated cream and syrup should be cleaned off before they cool down. Otherwise, vitreous ceramic surface may be damaged permanently.
---	---

If the surface is excessively dirty, apply the cleaning agent with a sponge and allow it to penetrate well. And then clean the hob surface with a wet cloth.

Any discolouration and stains on the vitreous ceramic surface are normal and they are not defectives.