

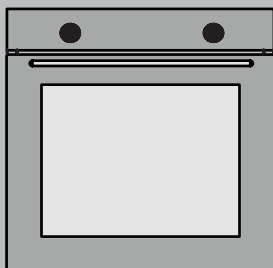

Ferre



Built-in Oven

User Manual

QXDMD 642 CS

QXDMD 642 CB

QXDMD 642 MI





EN

Dear Our Precious Customer,









Thank you for choosing a product. We would like you to be satisfied with our product, which has been produced in our highly qualified, technological and modern facilities.

You can use your oven with pleasure and confidence for many years by performing required maintenance and showing necessary care. Read the whole manual. Retain the manual during use of the product. If you hand the product over to someone else, give them the manual as well.

 This Operating Manual is prepared for multiple models. Some of the features mentioned may not be available in your product.

Symbol	Meaning
	Important Information
	Warning - Caution
	Risk of Electric Shock
	Risk of Fire

CONTENT

1.Important Safety Warnings 	4
General Warnings	4
Electrical Hazard	5
Risk of Injury.....	6
Intended Use	6
2.Environmental Protection 	7
Saving Energy.....	7
Compliance With WEEE Regulation and Disposal of The Product.....	8
Technical Specifications	8
3.Introducing the Appliance 	9
General Overview.....	9
Control Panel.....	10
Heating Types and Functions	11
4.Use of The Oven 	12
First use.....	13
Clock Setting	13
First Heating	14
Daily Use	14
Use of Digital Timer	15
Alarm Setup	18
5.Accessories 	20
Use of Accessories.....	21
6.Cooking Recommendations 	23
7.Maintenance and Cleaning 	25
Steam Cleaning Feature.....	25
Removing And Attaching The Oven Door.....	26
Removing And Attaching The Glasses	27
Removing And Attaching The Wire Racks.....	28
Replacing the Oven Lamp.....	29
8.Troubleshooting 	29

1.Important Safety Warnings

Read the manual carefully before installation and use of the appliance. The appliance shall not be covered under warranty in case of an incorrect installation or use performed by a person other than a specialist.



General Notes

- Follow the safety related instructions.
- This appliance is designed and manufactured exclusively for domestic use. It is not a commercial/professional equipment.
- Also read other documents that are provided together with the appliance.
- The user manual may be convenient for more than one model.
- Keep it in an easily accessible place for a future use.
- Disconnect all the energy connections before installation, maintenance and repair operations.
- If the appliance is damaged, do not operate it.
- If there is protective gelatin on the panel or cover of your device, please remove it.
- Keep the children under 8 years old and the pets away during and after use of the appliance.
- It is dangerous for the children under 8 years old to touch the appliance without an adult supervision and to use it on their own.
- Keep the packaging materials out of reach of the children, dispose them in a place where they cannot reach.
- Do not bring damp package into contact with the mouth. Keep it out of reach of the children.
- The appliance should not be maintained and cleaned as long as the children are not under the supervision of the adults.
- The appliance is only intended for cooking. Do not use the appliance for the purposes such as heating the room.
- While the oven is hot, tray and accessories may become hot; use oven gloves or a similar apparatus when you place and remove them.
- Do not use steam cleaner for cleaning the appliance.
- Keep the surrounding area of all the compartments, where there is an air circulation, open.
- If you would use an oily baking paper, absolutely do not bring the paper into contact with the base of the oven.
- Do not prepare food with strong alcoholic drinks. Alcohol vaporates at a high temperature, it may catch and cause fire in case of contact with hot surfaces.
- Check whether the appliance is turned off or not after use.
- Keep the cooking duration under control.

Electrical Hazard

 There is a risk of electrocution.

- The appliance should be repaired by an authorized service if it is damaged.
- In case of any damage, turn off the appliance, cut off the electricity.
- Due to the risk of electric shock, do not wash the appliance by spraying or pouring water on it.
- If the lamp would be replaced, disconnect the appliance from the electrical outlet in order to avoid from electric shock before the replacement.
- Our company is not responsible from any damage that would arise for the reason that the appliance is used without connecting it in accordance with local regulations.
- Absolutely do not use the plug with wet hands.
- In order to disconnect the appliance from the electrical outlet, plug it out by holding the plug, not the cable.
- While the appliance operates, its rear surface also gets warm. The electrical connections should not come into contact with the rear surface.
- Unplug the appliance during operations such as cleaning, repair and maintenance.
- Do not dislodge the resistor during cleaning.
- Do not pass the connection cables over the hot surface. If the cables melt, they may cause a short circuit or a fire.

 Do not try to extinguish the fire with water.

- Disconnect the appliance from the electrical outlet and try to cover the fire with an instrument such as a fire blanket in order to prevent the fire from coming into contact with the air.

Risk of Injury

- If there is a crack on the oven door glass or it is exposed to an impact, the glass may break and splatter.
- In order to clean the oven door glass, do not use harsh and abrasive cleaners or metal scrapers.
- Do not touch the heating/power elements.
- The hinges of the appliance door may jam the door during movement. Do not hold the section which contains hinges.
- Never leave combustible materials or oxidizers in the appliance.
- Do not heat glass jars and canned food. Created pressure may cause the jar to explode.
- Do not put the tray close to combustible materials or oxidizers after cooking.
- The oven door may consist of 2, 3 or 4 glasses. Do not use the oven door with a removed glass.
- The user should not carry the oven on his/her own without gloves.

Intended Use

- The appliance is intended for cooking. Do not use it for purposes such as heating.
- The appliance has been designed for domestic use. Use it only in a closed area.
- The oven can be used for defrosting, frying or grilling the food.
- Do not use the oven for drying purposes by hanging a towel or clothes on its handle.

2. Environmental Protection

Saving Energy

To learn what should be done while cooking a food in the oven, first of all, we need to talk about pre-heating. You should apply pre-heating only when it is required. Pay attention not to apply pre-heating for more than 10 minutes.

- Before cooking, put the frozen food in the oven after you leave them at the room temperature or defrost them in the microwave oven.

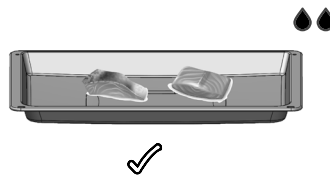

- Do not leave unnecessary accessories in the cooking compartment.

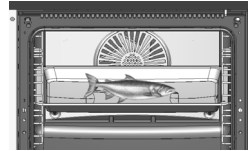
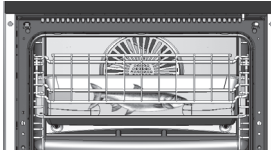

- You can cook more than one food on the wire rack at the same time. Thereby, you save heat.

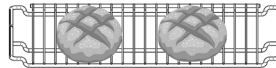

- The oven door causes heat loss every time it is opened. For this reason, you should not open the oven door unless it is highly necessary. When you need to open the oven door, pay attention to close it as soon as possible.



Compliance With WEEE Regulation and Disposal of The Product



Dispose of the old product in a way not harming the environment. On this product, there is a symbol (WEEE), which indicates that electrical and electronic equipment wastes should be collected separately.

This means that the equipment should be handled in accordance with 2002/96/EC EU Directive for recycling or dismantling in order to minimize the impacts of it on the environment.

For further information, please refer to local or regional authorities.

The electronic products, which are submitted for controlled waste collection, pose a potential hazard in terms of both environmental health and human health due to the harmful materials they contain.

You can consult with your authorized dealer or the garbage collection centre of your municipality about how you can dispose of the product. Before disposing of the product, unplug the power cord and break the cover lock, if present, to protect children from danger.

Technical Features

Voltage/Frequency	220-240V~50-60 Hz
Cable Length	With G Type Plug 3 x 1.50 x 1500 mm
External Sizes (height/width/depth)	595 mm/595 mm/547 mm
Main Oven	Electroturbo oven
Lamp Power	25 W
Thermostat	50-Max°C
Lower Heater	1200 W
Upper Heater	1100 W
Grill	2450 W

Essential: Energy label information have been indicated according to EN 60350-1 / IEC 60350-1 standards for domestic type electric ovens. The values are determined according to standard load, lower-upper heater or fan supported heating (if any) functions.

ⓘ The properties are subject to change without giving a prior notice in order to increase the quality of the product.

3.Introducing the Appliance

General Overview

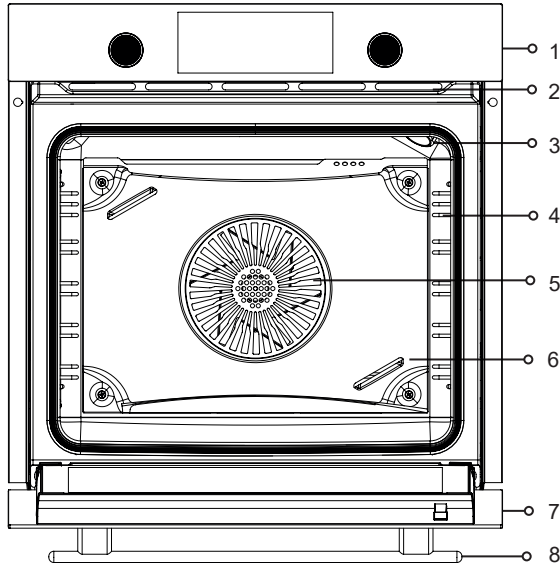

1-Control Panel

5-Fan

2-Air Vents*

6-Fan Protection Sheet **

3-Oven Illumination***

7-Cover

4-Racks****

8-Handle

***Air Vents** may be open/closed depending on your model.

It may not be available depending on your ****FPS** model.

The position of the *****Oven Illumination** may vary.

******Racks** may vary depending on your model. Wire rack is demonstrated as an example.

Control Panel

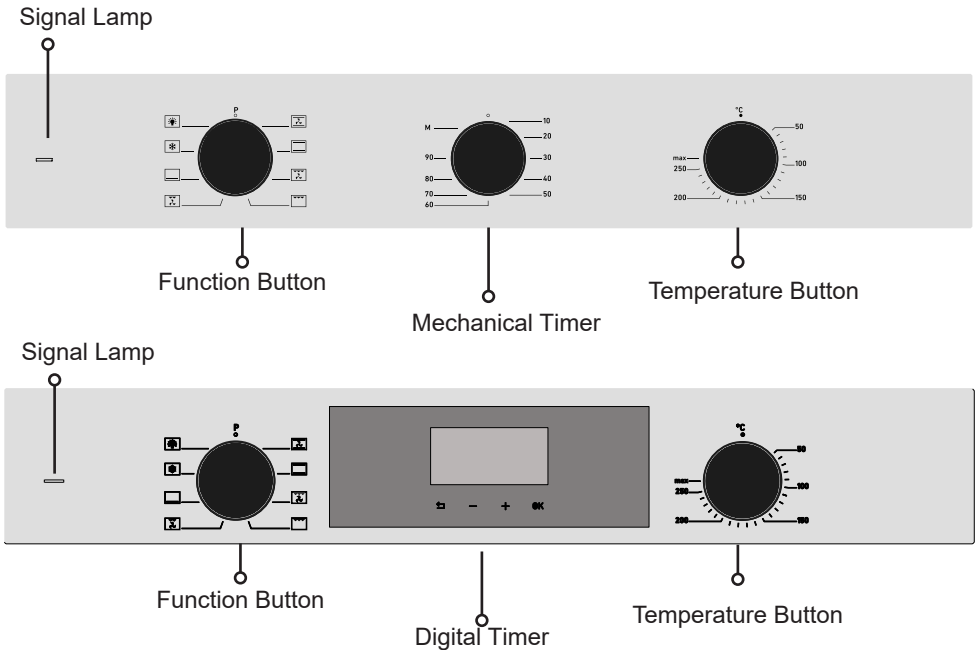

Function Button

Heating/cooking type is adjusted with function selection button.

You also need to set temperature button to a value with function selection button. Otherwise, the product will not start to heat.

Temperature Button

It allows you to select the temperature of the oven. The cooking is started by selecting the function type.

Mechanical Timer

It allows you to determine the time for the food to be cooked. The function and temperature knob must also be set.

Digital Timer

It is an electronic timer which makes the food to be cooked prepared at the time you desire.









Signal Lamp

It is the lamp which indicates that the oven is heated. It goes out when the oven reaches to the adjusted temperature.

Turning Off The Electric Oven

Switch the function and temperature buttons to zero (turned off) position.

Heating Types And Functions

	Fan Supported Lower and Upper Heating	Lower + Upper Heating and Fan are turned on. It is convenient for the food such as meat, cakes, biscuits. By the help of fan, the air circulation is performed in a controlled way and evenly within the oven.
	Lower and Upper Heating	The food are heated in the same way downwards and upwards. Upper and Lower heating are turned on. It is convenient for the food such as cakes, pastries.
	* Fan Supported Big Grill	The grill and fan operates together. The fan distributes the hot air evenly. It is convenient for cooking large sized meat dishes,
	Big Grill	It is convenient for grilling and frying big and medium portion meals. It heats the whole area under the heater.
 = 	*Fan Supported Small Grill	Small grill and fan are turned on. You can cook your food, which require to be cooked for a long time, by saving energy. Its cooking duration is longer than other functions. It is not recommended for leavened food. This mode is the highest mode for energy efficiency.
	Lower Heating	Only Lower heating is turned on. If the bottom of the meal, which is being cooked, needs to be fried, use the programme towards the end of the cooking. Also use this function for Steam Cleaning.
	Defrosting	The fan circulates the air around the meal and defrost the frozen food such as meat, bread and cake.
	Oven Illumination	It helps to illuminate the inside of the oven. When you switch it to the oven illumination position, the heaters and the fan do not operate. The light will remain on as long as the oven operates.

① The functions, which are available on the table, may vary in the different appliances, they may not be available in every model.*The related energy value in the fan supported cooking mode has been indicated based on this function.The performed tests have been based on TS EN 60350 standard and (EV) No 66/2014 regulation.

Pop-out Button Use

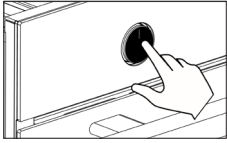

- In the models with a pop-out button, the button should be on the outside in order to apply the setting. (This button is optional.)
- Remove the button out by pressing on it as shown in the picture.

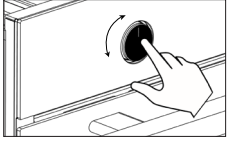

- You can adjust the button by turning it when it is outside.

Use of Mechanical Timer

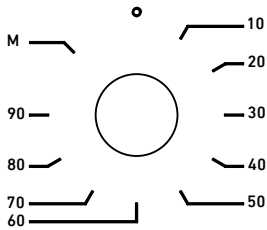

It allows you to set the time for the food to be cooked.

You can set it by selecting the temperature and type of cooking, turning the cooking time clockwise. When the time is up, it warns with a ringing sound. If you wish, you can start cooking by selecting the temperature and type of cooking without selecting a time by setting it to **M** mode.

4. Use of The Oven

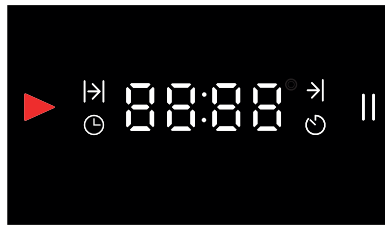

⏪ - + OK

	"In progress" indicator		Pause indicator
	Cooking duration indicator		Back button
	Cooking completion indicator	OK	OK button
	Clock setting indicator	+	Time increasing button
	Alarm indicator	-	Time decreasing button

First Use



Clock Setting

① Apply the clock setting before starting to use the oven.

All numbers light up and go out for 2 seconds after establishing the power connection.  12:00 appears on the screen.

①   buttons, you can change the time more quickly.



Firstly, the minute is entered and it is confirmed with **OK** button and you switch to the clock.

As the minute field flashes, when you press on  button for a short time, the clock setting shall be terminated without recording any data. In order to return to the minute field while performing the clock setting, press on  button for a short time.

① As long as the clock data are not confirmed, the screen shall stay as the setting screen.

① In case of a power failure, the time of the day is cancelled and you should apply the setting again.



Firstly, select the minute with   **OK** button.

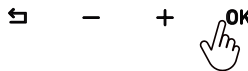
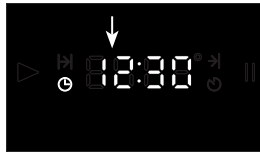

After that, select the clock and confirm it with **OK** button.





The time of the day appears.

The clock is set and  indicator disappears.

The brightness on the screen decreases 1 minute after the setting is applied.

Afterwards, you can change the time of the day from '**Settings Mode**'.

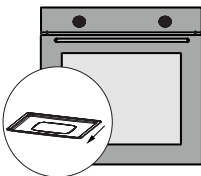
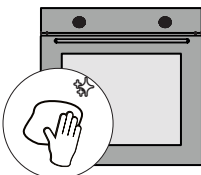
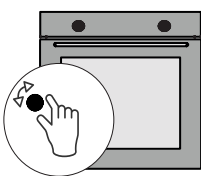
First Heating

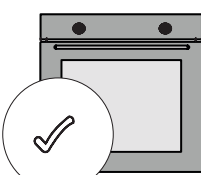
	Remove the labels and take out the accessories before using the oven.
	Wipe the oven with a damp cloth and dry it. Refer to “ Maintenance and Cleaning ” section and review it detailedly.
	Perform the first heating in order to remove the new appliance smell. Operate the oven at the Lower + Upper  position, while its door is closed, for 200°/30 min. Then, ventilate the room.
	You need to be careful while opening the oven’s door because vapour may arise after heating. Place the accessories. Your oven is ready to use.

 The surfaces become warmer than normal during the first operation. For this reason, do not touch the oven and keep the children away.

Daily Use

- In order to start cooking, adjust the thermostat button of the oven and the suitable temperature (Cooking Recommendations) for the food.
- Preheat the oven, if pre-heating is desired.
- After cooking, leave the oven to cool down while its door is open.

 When the cooking duration ends, remember to turn off the oven’s function and temperature button.

Use of Digital Timer



It is an electronic timer which makes the food to be cooked prepared at the time you desire. You should adjust the cooking duration of the meal and the time when you desire it to be prepared.

⏪ - + OK

Automatic Cooking Programme

After selecting the temperature and function, which are suitable for the meal you put in the oven, you shall start the cooking immediately by adjusting the cooking duration. **In order to adjust the cooking duration;**



⏪ - + 

|> press and hold **OK** button until indicator appears.



⏪ -  OK

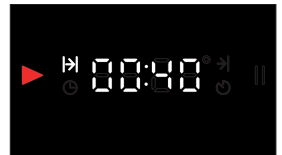

Firstly, select the minute with **-/+** buttons and activate the clock by pressing on **OK** button.
(e.g.; 40 minutes)





⏪ - + 

with **OK** button, move forward until the screen above appears and start the cooking.

- The time, which is set on the screen, starts to count down. Adjust the temperature and the function you desire. The oven shall cook for 40 minutes beginning from the moment you confirm the time.
- When the adjusted time is up **00:00** **||** appears on the screen, indicator flashes **||** and it gives an audible alarm for 2 minutes. In order to turn off the alarm, press on **OK** button. After turning it off, the time of the day appears on the screen.
- When the cooking ends, switch the temperature and the function to the closed position and turn off the oven.

 In order to complete the cooking before the adjusted time and cancel the selected time, long press on  button. The time of the day appears on the screen.

Pause Mode

When the screen indicates the time of the day and you long press  button, the time of the day and  symbol appear and the oven switches to pause mode. In this case, you cannot cook. When you press on **OK** button for a short time in order to exit the mode,  symbol appears and is deactivated.

 Operation continues while the commutator is turned on.

Setting The Cooking Ending Time Forward

This programme is used provided that you desire your meal to be prepared in the upcoming time. It starts with delay. After the delay ends, the cooking starts and adjusted cooking time completes in the end.

By entering cooking duration;

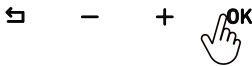
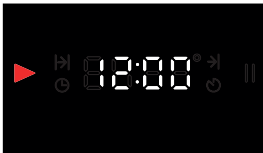

 press and hold **OK** button until indicator appears.



Firstly, select the minute with **-/+** buttons and activate the clock by pressing on **OK** button.

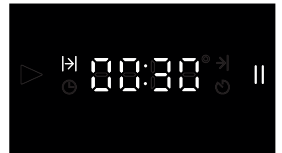

After selecting the time, confirm it with **OK** button and proceed to  mode.

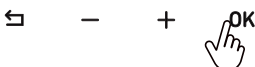
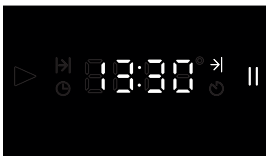

For cooking completion, after selecting the minute and the hour, move forward with **OK** button until the cooking screen appears.

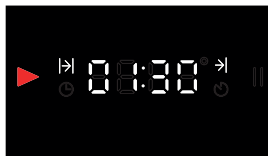

Cooking screen;
Cooking screen; The time left until the end of the cooking.

Oven time indicates the remaining time on the screen by subtracting the time of the day from the ending time and it starts to count down.

We set our oven to start cooking at 01:00 p.m., cook for 30 minutes and end the cooking at 01:30 p.m. When the cooking ends, **||** indicator flashes and it gives an audible alarm for 2 minutes. In order to turn off the alarm, press on **↶** or **OK** button.

When the cooking ends, switch the temperature and the function to the closed position and turn off the oven.

without entering cooking time;

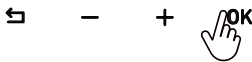

→ press and hold **OK** button until indicator appears.



Without entering the cooking duration, move forward with **OK** button and proceed to **→** mode.

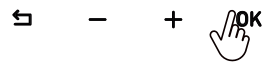

For cooking completion, after selecting the minute and the hour, move forward with **OK** button until the cooking screen appears.

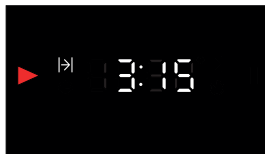

Cooking screen;

Cooking screen; The time left until the end of the cooking.

Manual Cooking Mode

You can start cooking immediately without adjusting the duration by selecting the temperature and the function which are suitable for your meal. The oven does not turn off automatically and you should observe it.

- ① In case of a power failure, your oven shall be deactivated and the clock shall be reset. You should adjust the time of the day again when the power is back on.

Alarm Setup

Alarm can be set at any time. You can use it as a warning or reminder. The alarm indicator shall go out after the alarm rings for 2 minutes. Until the  indicator appears, press and hold **OK** button.

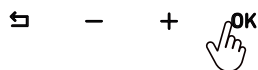

OK with button 
move forward until the
indicator appears.



Firstly, select the
minute with **- / +**
buttons, by pressing
on **OK** button, select
the hour and confirm
it with **OK** button.



After the duration is
adjusted, the screen
indicates the time of
the day.

Turning Off The Alarm

The alarm shall ring for 2 minutes after the adjusted time is up. In order to turn off the alarm, you can press on **OK** or  button. After turning it off, the time of the day appears on the screen.

Setting Mode

Alarm Tune Setting (AL)

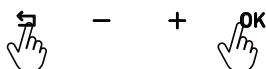

Long press  and
OK . buttons together
and enter the menu.



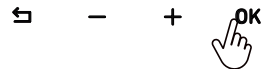

With **- / +** buttons,
proceed to **F1** option
and confirm it with
OK button.



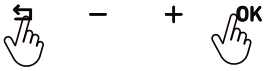

With **- / +** buttons,
select the level you
desire and confirm it
with **OK** button.

Changing The Time (CL)



Long press  and  . buttons together and enter the menu.



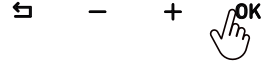
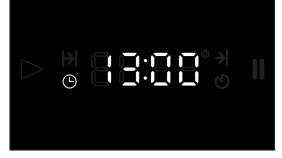

With $-/+$ buttons, proceed to   option and confirm it with  button.





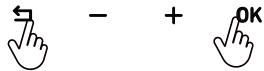

Select the minute and the hour with $-/+$ buttons and confirm it with  button.

Changing The Tone (So)



Long press  and  . buttons together and enter the menu.



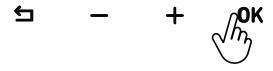

With $-/+$ buttons, proceed to    option and confirm it with  button.





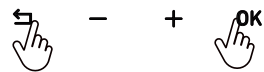

With $-/+$ buttons, select the level you desire and confirm it with  button.

Changing The Brightness of The Screen (Sc)



Long press  and  . buttons together and enter the menu.



With $-/+$ buttons, proceed to    option and confirm it with  button.

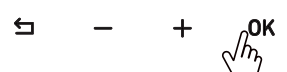
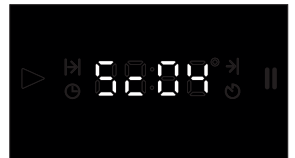

With $-/+$ buttons, select the level you desire and confirm it with  button.

5. Accessories

- ① The accessories, which are provided based on the model of the appliance, vary. The accessories, which are mentioned in the user manual, may not be available in the product.
- ① Use the original accessories, which are designed for the appliance.

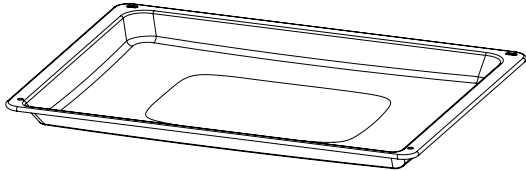
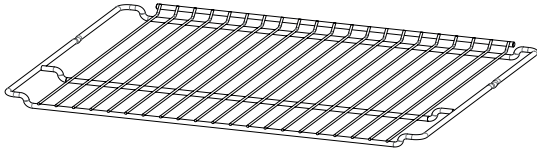
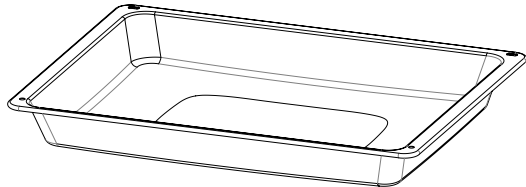
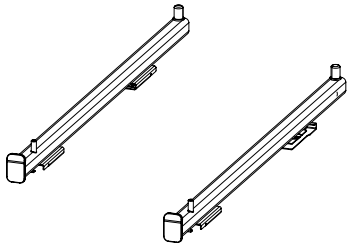
 A rectangular metal tray with a slightly raised rim and a central recessed area.	<p>Standard Tray</p> <p>It is intended for frozen food, cakes, large sized meat dishes, pastries.</p>
 A rectangular metal wire rack with a grid of parallel bars.	<p>Wire Rack</p> <p>It is intended for cake and soufflé moulds and for placing the food to be fried on the rack.</p>
 A rectangular metal tray with a deep central well and a raised rim.	<p>Deep Tray</p> <p>You can use it for stews, fried food in large pieces and for collecting the dripping oils when you grill the food.</p>
 Two telescopic metal rails, one shown in its extended state and the other in its retracted state.	<p>Telescopic Rail</p> <p>Telescopic rails can be pulled completely out of the oven. You can easily move your tray and wire grill to control your meals.</p>

Use of Accessories

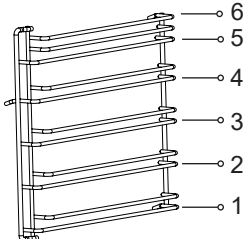
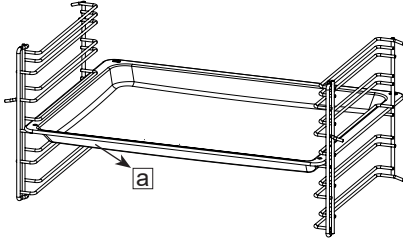
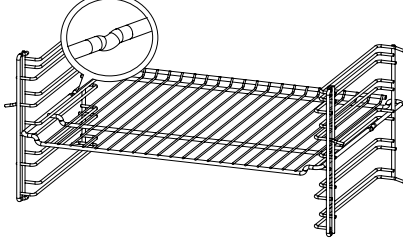
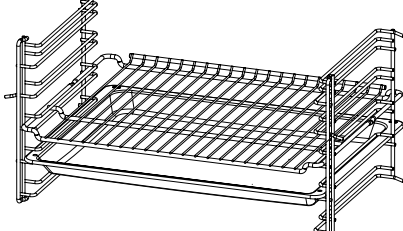
	<p>There are models with wire and self adjusting racks. Wire rack has 6 cooking rack.</p>
	<p>Accessories should be placed between two racks and the side with a inclination should face the door of the appliance.</p>
	<p>The cavities on the wire rack prevent it from falling off the racks and ensure the safety.</p>
	<p>You can use the tray as a drip cap for grilled food and meat dishes by placing the tray and the rack together.</p>

Use of Telescopic Rail

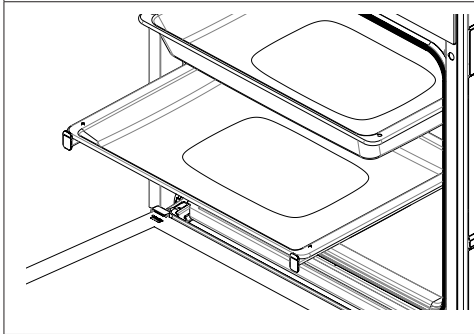
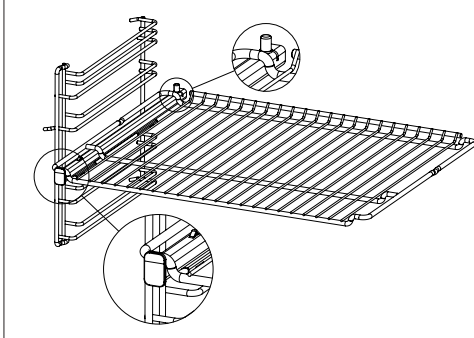
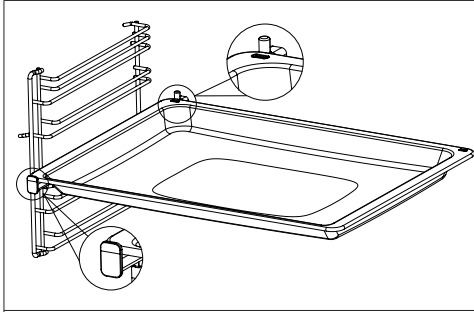

Push the rails completely inside without placing the tray and wire grid on them. Accessories must be between the front and rear overhangs of the rails.













If you are going to cook with more than one tray, there should be a level of distance with the rail system.











6. Cooking suggestions

You can see the details of the food, which we have tested in our laboratories and whose cooking values have been determined by us, in the table. The cooking times may vary depending on the grid voltage, the nature and the amount of the material to be cooked and the temperature. By trying out, you can change the values to achieve different tastes and the results, which are suitable for your palatal delight.





The lowest rack of the oven is the 1st rack.

*** It is recommended to apply 10 min. pre-heating.**

Food	The accessory to be used	Cooking function	Rack position	Temperature (°C)	Cooking duration (min)
Cake in a tray	Standard Tray		2-3	170	20...25
			2-3	160	15...20
Cake in a mould	Cake Mould		2	170	35...40
			2	160	25...30
Cookie	Standard Tray		2	170	20...25
Small cakes	Standard Tray		3	160	30...35
			3	160	25...30
Puff pastry (cheese)	Standard Tray		2	200	35...40
			2	190	25...30
Puff pastry (spinach)	Standard Tray		2	200	40...45
			2	190	25...30
Pizza	Standard Tray		2	200	10...15

Pastry	Standard Tray		2	200	25...30
Fish	Standard Tray		3	200	30...40
			3	200	20...30
Lasagna	Glass on the wire rack/ rectangular		2	190	20...25
Chicken drumstick	Standard Tray		2-3	220	50...55
			2-3	220	40...45
Whole chicken (2 kg)	Standard Tray		2-3	30 min. max, then 60 min. 190	90...95
			2-3	25min. max, then 50 min. 190	75...80
Entrecôte	Standard Tray		3	30 min. max, then 30 min. 190	55...60
			3	25 min. max, then 20 min. 190	45...50

Grilling Table

Food	The accessory to be used	Cooking function	Rack position	Temperature (°C)	Cooking duration (min)
Lamb chops	Wire rack		4...5	max.	25...30
Chicken in pieces	Wire rack		4...5	max.	25...30
Fish	Wire rack		4...5	max.	20...25
Sandwich loaf	Wire rack		4...5	max.	1...3



* It is recommended to apply 5 min. pre-heating.

7.Maintenance and Cleaning

ⓘ Before starting to perform maintenance and cleaning, disconnect the appliance from the electrical outlet against the risk of electric shock.

⚠ Before performing maintenance, make sure that the appliance is cold.

You can extend the lifetime of the appliance by performing regular maintenance and cleaning. You can remove the door, the glass and the racks for cleaning.

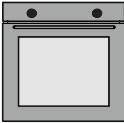
 <p>Cleaning Recommendations</p>	Do not use scratching, abrasive tools such as knives, brushes on the internal and frontal parts, trays and other parts of the appliance. Clean and dry the appliance with warm water and soapy, soft cloth.
 <p>Accessory Cleaning</p>	Clean and dry the accessories thoroughly after use. Do not wash the accessories in the dishwasher.
 <p>Daily Use</p>	The appliance should be cleaned thoroughly after use. The wastes, accumulated oils may cause fire.

Steam Cleaning

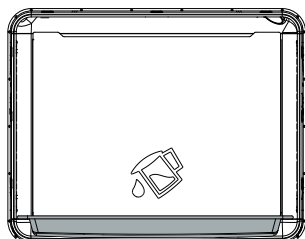

The dirt can be wiped easily by softening them after cooking. Remove all the accessories (if there is a wire rack) from the oven. Place the single tray on the lowest base by adding some water in it and by selecting Lower Heating function ,  operate the oven at for 20 minutes. At the end of the operation, wipe the inside of the oven with a damp cloth or sponge.

Removing The Oven Door

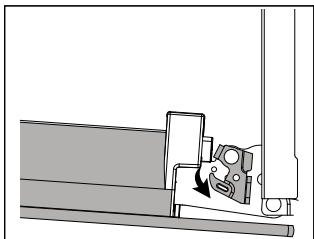
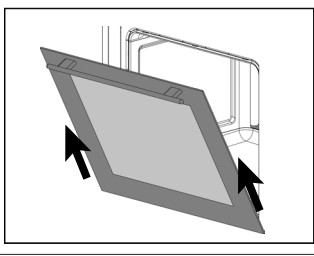
Step 1	Open the oven door fully.	
Step 2	Push the hinge locks in the direction of arrow and unlock them.	
Step 3	Close the oven door until it is brought to the position in line with the hinge lock. Pull it outwards in the direction of arrow.	

Attaching The Oven Door

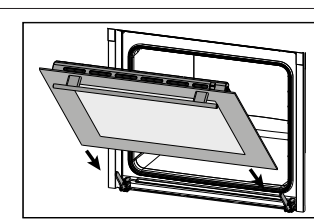
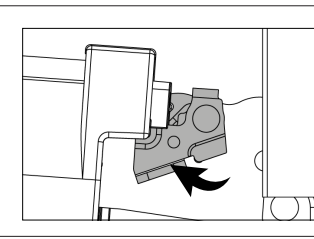
Step 4	Place the appliance door into the hinges in the direction of the arrow.	
Step 5	Open the appliance door fully and switch the hinge locks to the closed position in the direction of arrow. Close the oven door.	

Removing The Glasses

The number of the glasses may vary according to the model.

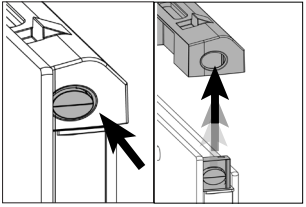
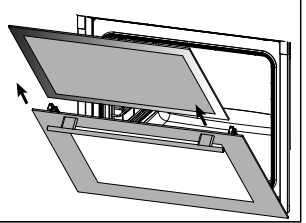
Step 1	Open the oven door halfway.	
Step 2	By pressing on the right and left side of the upper plastic section, pull it upwards.	
Step 3	Firstly, pull the internal glass, then interim glass outwards in the direction of the arrow.	

Attaching The Glasses

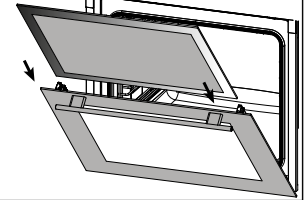
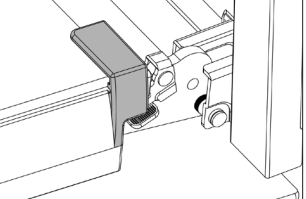
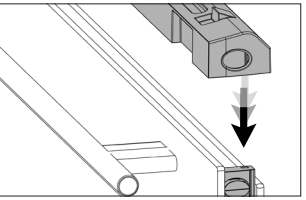
Step 4	Open the oven door halfway and firstly, push the interim glass, then the internal glass in the direction of the arrow.	
Step 5	Make sure that the glass is inserted into the housing of the lateral plastic section correctly.	
Step 6	Place the upper plastic section in a way that you can hear the click sound and close the appliance's door.	

Removing The Wire Racks

⚠ The racks may be hot, do not touch the racks when they are hot. Wait for them to cool down.

① The cleaning process of the oven's side walls may vary depending on the appliance model. This feature may not be available in your appliance.

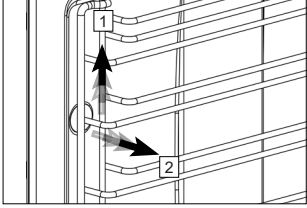
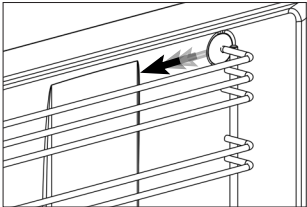
Step 1	Firstly, lift the rack carefully from the front hanger (1) in the direction of the arrow and remove it (2).	
Step 2	Afterwards, pull the whole rack out in the direction of the arrow.	

Attaching The Wire Racks

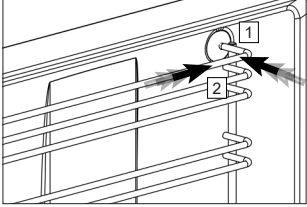
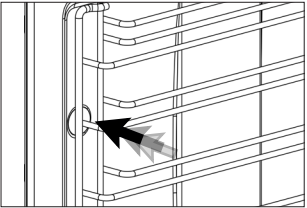
Step 3	Center the racks and firstly, place the rear hanger (1) and press on it (2).	
Step 4	Then, press on the front hanger. Thereby, the rack would be attached.	

Replacing the Oven Lamp

⚠ Due to the hazard of electric shock, make sure that the power is out before replacing the lamp. The lamp may be hot, wait for it to cool down.

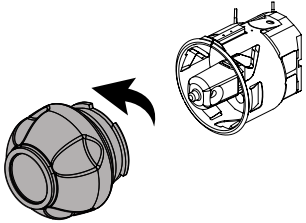
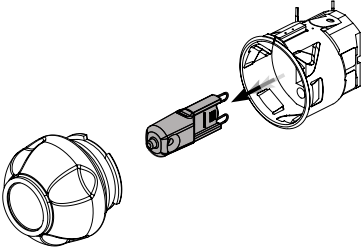
Step 1	Open the oven door fully.
Step 2	Turn the glass door counter clockwise and remove it. 
Step 3	Pull the oven lamp out in the direction of the arrow and replace it. Reattach the glass door. 

8. Troubleshooting

The malfunctions mentioned here are the situations that may occur usually. You can solve these problems easily without interfering with the product yourself.

- ⓘ** If the problem cannot be solved despite the instructions, call the dealer or the Authorized Service where you have bought the appliance from. In this case, never try to repair the appliance on your own.

Problem	Reason	Solution
The appliance does not operate.	The appliance may not be plugged in.	Make sure that the appliance is plugged in.
	The fuse may have blown or be broken.	Check the fuses in the fuse box. If the fuse has blown, engage it.
While the appliance operates, steam comes out.	The oven is used for the first time.	Steam may come out during operation. This is not a malfunction.
The outside of the oven becomes too hot during cooking.	It is in a place, which is not well-ventilated.	Apply the spaces, which are indicated in the installation manual.
The oven does not cook properly.	The oven door may open too much during cooking.	Do not open the door too much to ensure that the internal temperature does not decrease.
The cooling fan still operates after the cooking ends.	It operates for a while in order to ventilate the inside of the oven.	This is not a malfunction.
Metal sounds come while the appliance gets warm or cools down.	The sounds, which are heard because the parts expand as a result of the heat, are normal.	This is not a malfunction.
The door is not closed entirely.	The leftovers may be stuck inside the oven and on the door.	Clean the oven.
The oven does not heat.	<ul style="list-style-type: none"> • The door may have remained open. • The function or the temperature may not have been adjusted. • The power may not be supplied. 	<ul style="list-style-type: none"> • •Check the door and make sure that it is closed entirely. • •Switch the oven to a specified temperature and/or the function.

QX

