



Liberta Nevada



Liberta NEVADA

Assembly Instructions

You should have:

All Assembly parts of Nevada Cage Shown for your reference

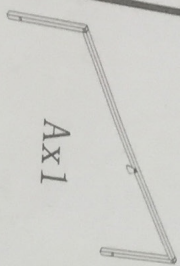

Ax1

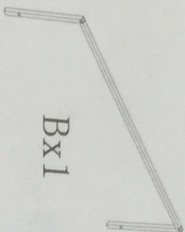

Bx1

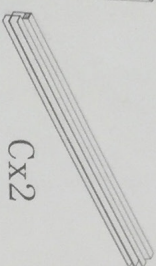

Cx2

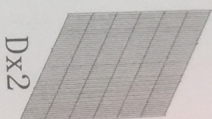

Dx2

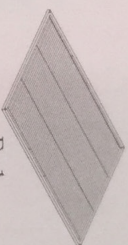

Ex1

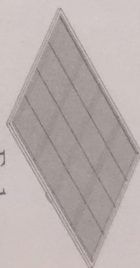

Fx1

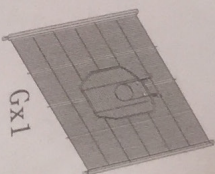

Gx1

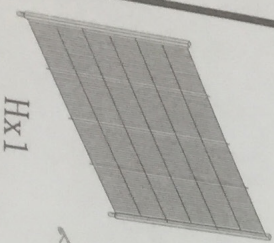

Hx1

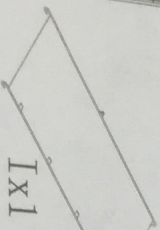

Ix1

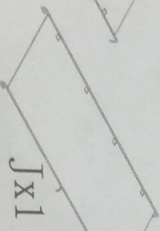

Jx1

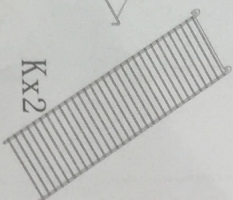

Kx2

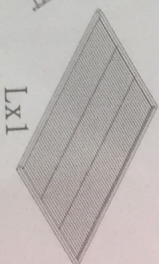

Lx1

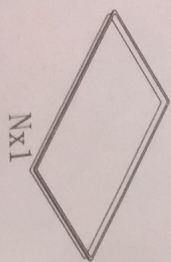

Nx1

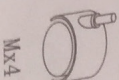

Mx4

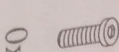

Ox12

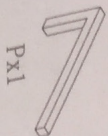

Px1

A. front frame

B. back frame

C. right & left frame connector

D. right & left side wire mesh

E. top wire mesh(6 holes on side tube)

F. grille

G. front wire mesh

H. back wire mesh

I. left platform

J. right platform

K. ladder

L. bottom wire mesh on stand

N. metal tray

M. wheel

O. screw

P. wrench (screw all bolts)

It is recommended that two people assemble this cage

Step 1

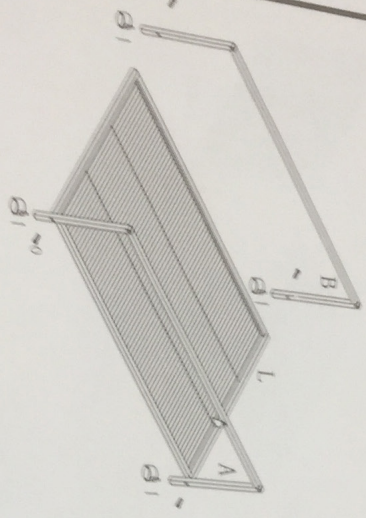
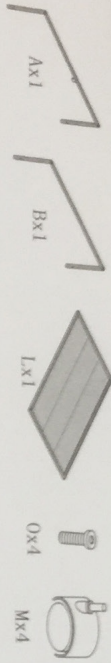

Connect L to A and B with 4 of screw O, and insert wheels into the legs of cage.

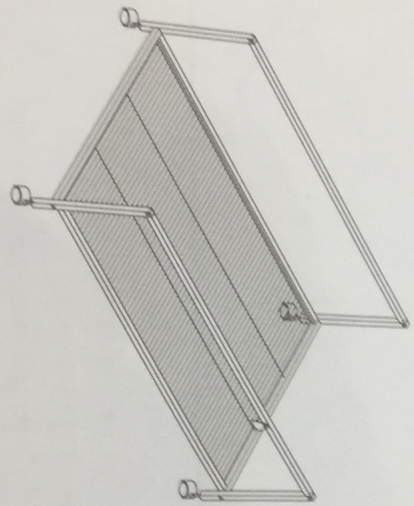

Step 2

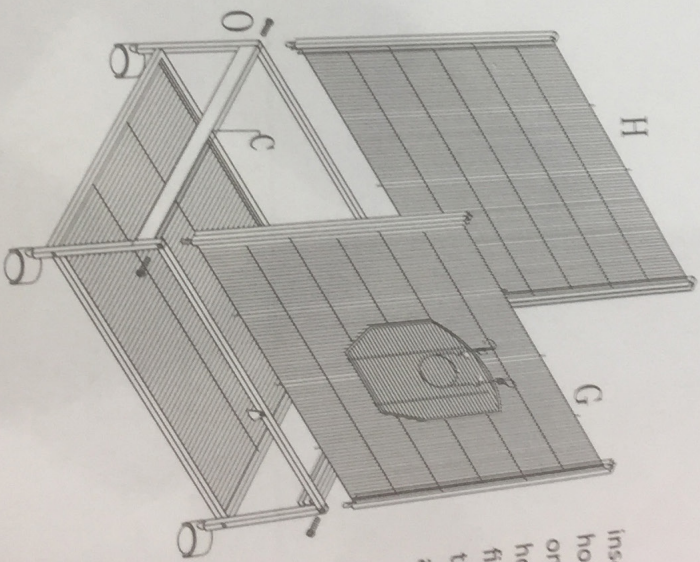
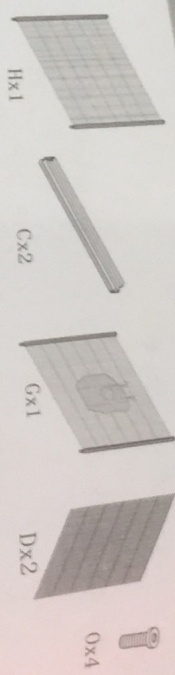

Insert G&H into the holes, then put 2 of C onto the position, 1 hole upwards, finally screw C,H,G together by O (shown as drawing)

to be continue...

Step 3

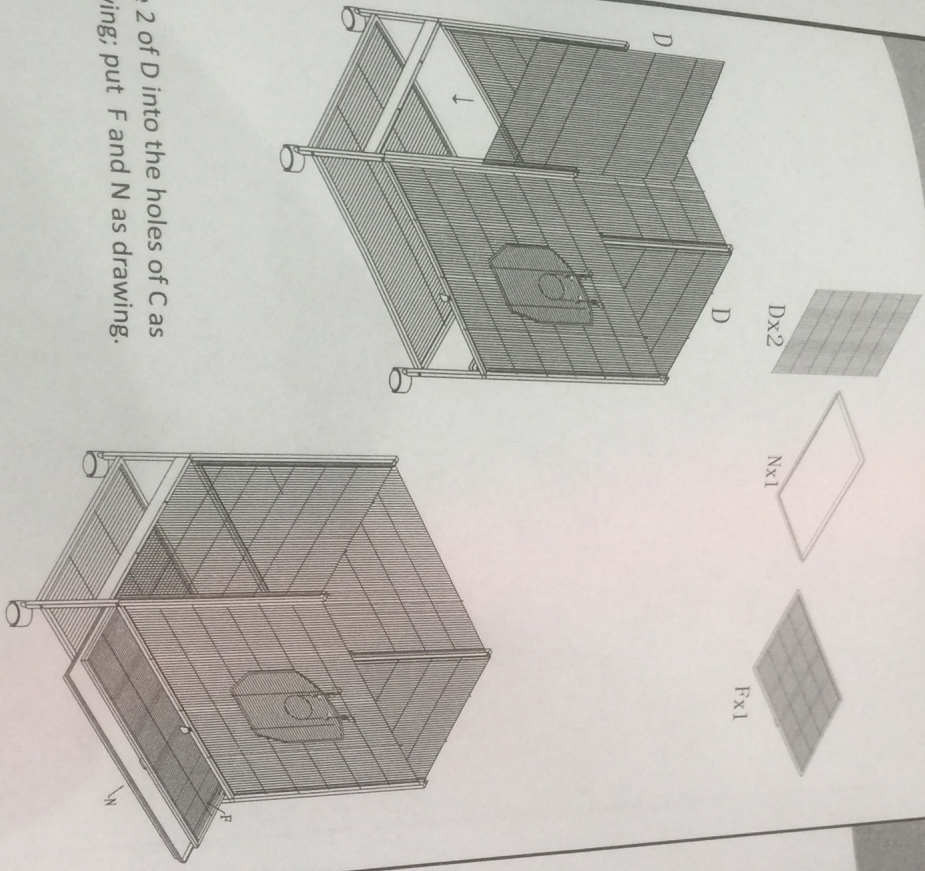

slide 2 of D into the holes of C as drawing; put F and N as drawing.

Step 4

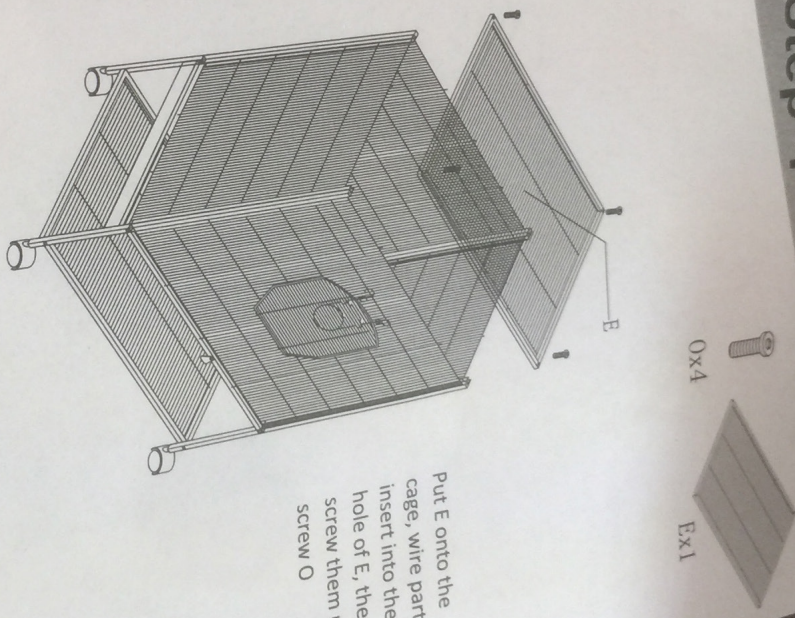

Put E onto the cage, wire part insert into the hole of E, then screw them up by screw O