

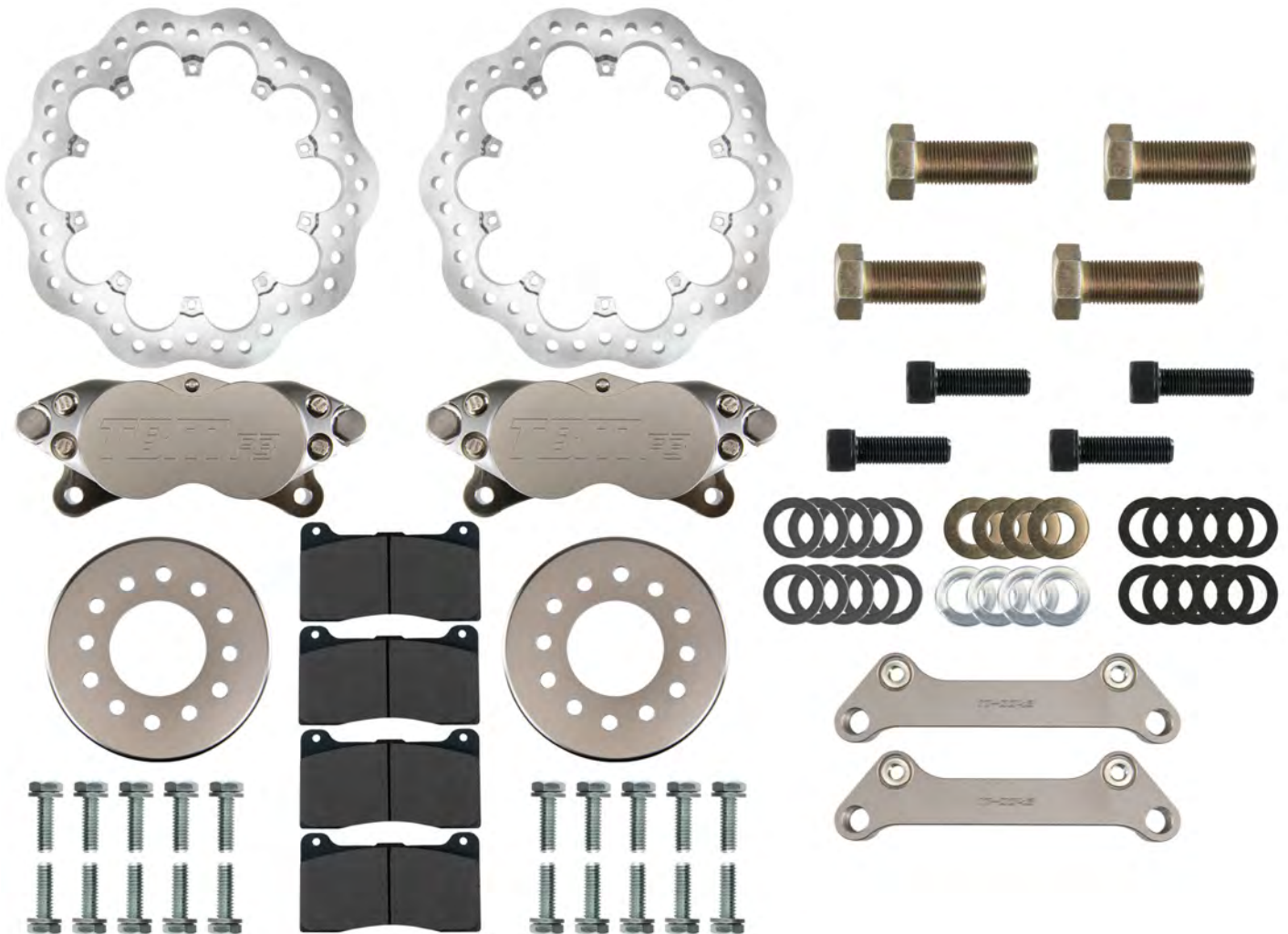



TMBBRAKES







**2011-2023 F-150 F3 FRONT BRAKES
(REUSES FACTORY HUBS)
(001-0329)**

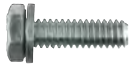

Parts List

| | | |
|--|---|---|
|  | 2 | Revolution Rotors - 12.50 / 0.500 / 10 on 7.963” Part Number: 3-1250500107963D |
|  | 2 | Hat, F-150, Front Part Number: 204-0226 |
|  | 2 | F3 Caliper, 1.75” Diameter Piston, .500 Rotor Part Number: 002-0192SSP-1 & 002-0192SSP-2 |
|  | 2 | F3 to F-150 Drag Racing Caliper Brackets Part Number: 17-0043 |
|  | 4 | F3 Replacement Pads (full set) - #1 Part Number: 6-0102W |

Hardware List 011- 0329

| | | |
|--|----|-------------------------------------|
|  | 20 | Bolt, 1/4-20 X 3/4 |
|  | 4 | Bolt, 3/8-24 X 1 1/4 |
|  | 4 | Washer, 3/8” Screw Size |
|  | 4 | Lockwasher, 3/8” |
|  | 10 | Shim, Steel, .010TK, 3/8 ID, 5/8 OD |
|  | 10 | Shim, Steel, .031TK, 3/8 ID, 5/8 OD |
|  | 4 | Bolt, 5/8"-18 x 1.75" |

Step 1: Lay the hat bowl-side up and place the flat side of rotor on the hat. It may be necessary to flip the rotor to achieve proper rotor spacing based on brand and build series of spindle.(Important: for your convenience, we recommend mocking up all fasteners and assembly before torquing and Loctite bolts).

Step 2: Apply Red Loctite to the 1/4 -20 hex bolts, torque to 10 ft-lbs.



Step 3. Place the caliper bracket on the face of the knuckle as shown below. Apply red Loctite to the 5/8"-18 x 1.75" hex bolts and tighten to 80ft/lbs.



Step 4. Slide hat and rotor assembly onto the hub and secure with studs.



Step 5: Slide the caliper over the rotor and mount it to the bracket. Snug the 3/8-24 bolts, lock washer, and washer. Check for proper radial and horizontal clearance between the rotor and the caliper.



Step 6: Remove the pad retainer bolt (if already inserted). Insert the brake pads from the top of the caliper and reinsert the pad retainer bolt. Hold the pads against the caliper housing. Spin the rotor assembly to check for contact between the rotor and brake pads. There should be no contact between the rotor and pads. Tighten pad retainer bolt.

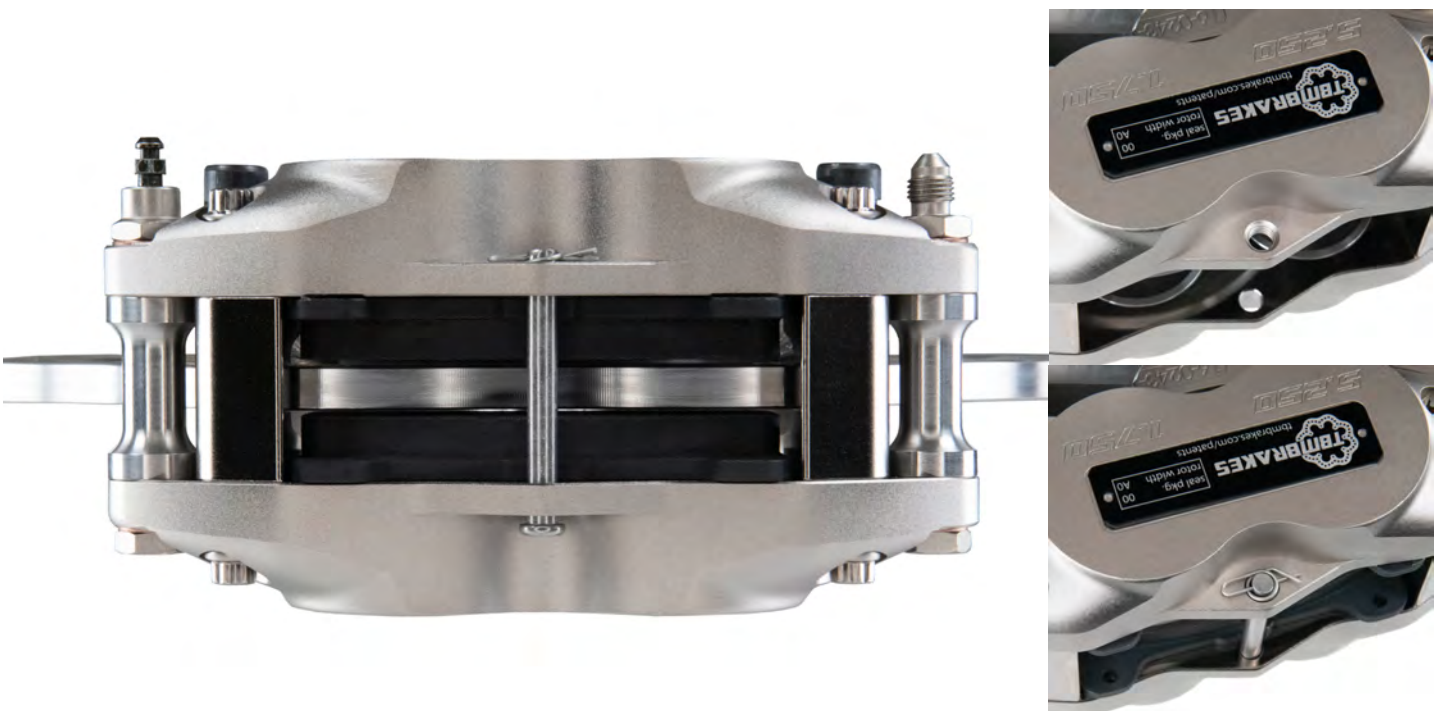

Step 7: If there is pad to rotor contact, determine which side is causing the interference. Shim the caliper or the bracket as needed using the supplied shim kit to center the caliper and ensure the caliper is parallel to the rotor. ****What is required for one side of the car may not be the same as the other side. Check each side individually****

Step 8: Verify the pad material is sitting in the proper location in relation to top of the rotor [flush +/- .06"]

Step 9: Go back and torque the caliper mounting hardware to 37 ft-lbs and verify that the bleeder screws are mounted in the top position. (See image below)

Step 10: Connect the brake lines check for interference with any suspension or driveline components. (All caliper fittings are -3AN)

Step 11: Bleed the entire brake system and verify proper caliper operation and release

If technical support/info is needed, please contact us at (800) 878-9274 or info@tbmbrakes.com

TBM Brakes • 1906 59th Terrace E • Bradenton, FL 34203

Updated: 1/24

WELCOME TO *TEAM TBM*

WE WANNA SEE YOUR *TBM RIDE!*

**TAKE SOME PICTURES OF YOUR BRAKES AND
OF YOUR RIDE AND POST THEM UP ON SOCIAL MEDIA**

GIVE US A *FOLLOW* AND *TAG* US ON *FACEBOOK* & *INSTAGRAM*



@TBM BRAKES

**#TEAMTBM
#TBM BRAKES
#WINWITHTBM
#THEBRAKEMAN**



TBM BRAKES

More Info

Caliper Direction: Calipers are labeled -1 and -2 with bleeders and fittings mirrored of each other. These don't indicate left or right; please ensure that the bleeder is mounted at the highest point.

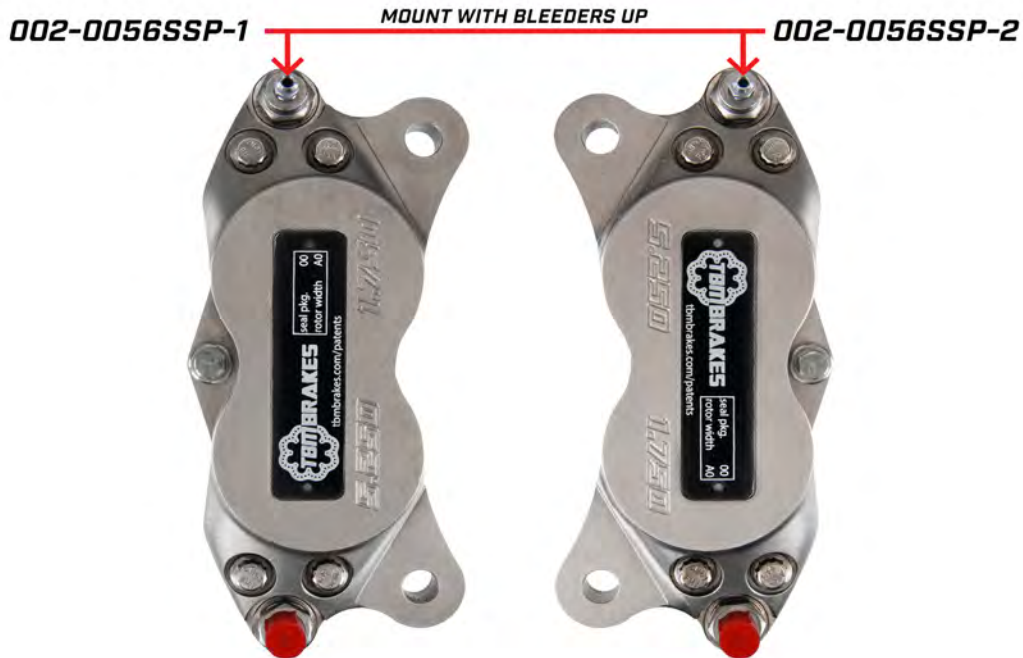

Acceptable Pad Thickness: Any time pads are $<.100$ " thickness, we advise replacing them.

Rotor Replacement: Our main concern is rotor flatness. This dictates the performance of the rotor. For rotor thickness concerns please reach out to us directly at (800) 878-9274 as rotor thickness varies on each rotor style

Fluid: We recommend using TBM Extreme 6 High Performance DOT 5.1 brake fluid on any and all TBM brakes. This fluid is compatible with Dot 3 and Dot 4 fluid without having to drain your fluid system if you are not able to get your hands on TBM brake fluid. DO NOT ever use DOT 5 brake fluid as it is silicone based and will cause the seals to swell, hindering brake performance and life.

Bearing Grease: If your TBM Brakes utilize a hub that uses greasable bearings, we suggest using any Premium Moly style grease. Our brakes ship with standard Timken bearings which are able to be used with normal bearing grease. Using this grease will still promote our no drag benefits.

Replacement Bearings: We use standard readily available Timken Part Number bearings in our kits to make replacement and servicing easy. In the event you need replacement bearings, use the part numbers listed in the kit instructions for reorder.

Loctite Hardware: We recommend Red Loctite on any and all hardware used in brake applications. Please follow proper procedures in cleaning and drying hardware and surfaces before applying to ensure proper results.

Flipping Rotors: Our rotors are designed to be flipped either direction when mounting; they are non-directional. Flipping the rotors allows you to utilize the offset either direction for properly centering/spacing the rotor and caliper package.

Replacement Hardware: Please note we only sell hardware as complete kits. The hardware kit number listed in the instructions above.

Cleaning Brakes: The unique color and finish on TBM Brakes is an Electroless Nickel process that is extremely durable. Cleaning electroless nickel parts is easiest by using household stainless steel appliance cleaner. Spray parts, let sit for 60 seconds, and wipe off. We recommend removing pads prior to using this cleaner and cleaning rotors off with brake cleaner after you've finished cleaning electroless nickel parts to avoid any chemicals that can adversely affect braking conditions.

Caliper Maintenance: Our calipers are engineered, designed, and built to be the most durable calipers on the market. We have customers with over 30 years of abuse on calipers with several reseals and rebuilds throughout. We recommend sending calipers used heavily in every 2 seasons for a cleaning, inspection, and rebuild process. During this time we pressure and leak check the calipers. Any caliper sitting more than 1 year with fluid should be sent in for reseal as seals can become compromised. Please contact us directly to arrange maintenance at (800) 878-9274.

Rotor Maintenance: Over time, pad transfer will build up unevenly on the rotor face. This can result in high spots on the rotor, excessive pad knock-back, inconsistent pedal feel, and/or a decrease in brake torque. It is good practice to routinely clean the pad swept face of the rotors with 80 grit on a dual-action sander or with one of our rotor hones. This can be done as part of a pre-race weekend routine, or something you keep an eye on and work into your mid-season routine. After cleaning the rotor face you will want to follow the bedding procedure to lay a new transfer layer of material down onto the rotor.

Bedding Procedures: When bedding a new set of pads and rotors you are looking to transfer an even layer of pad material onto the rotor. At the drag strip, this can be done by making 2-3 passes and getting on the brakes as you would on any other pass. Getting firmly on the brakes for a second or two to scrub-off speed then off them completely. Get back on them firmly to make the turn, then try your best to come to a stop on the return road without applying a lot of brake. With the rotors hot, coming to a complete stop with a heavy foot can result in high spotting the brake material on the rotors. If trying to bed new pads and rotors away from the racetrack, it is recommended to do so in a safe and controlled environment. Decelerate quickly 4-5 times from roughly 35-5 mph. Trying not to come to a complete stop. Then, decelerate quickly 4-5 times from 50-15 mph. Trying not to come to a complete stop. If the area permits, drive a 1/4 mile dragging the brakes slightly at safe speeds. Then drive an equal distance or more without getting on the brakes, giving the rotors time to cool before coming to a stop. From here, you should notice pad material starting to evenly lay across the pad swept face of the rotor.

Proper Caliper Shimming: Every TBM brake kit comes with several mil-spec shims. These are available to you for a couple of reasons:

- 1.** They can be used to shim the caliper off of the bracket or the bracket off of the spindle in order to get the rotor centered in the caliper. Getting the rotor perfectly centered in the caliper is desired but can be offset slightly inboard or outboard. Making sure the pads fall in the caliper freely and there is no caliper to rotor clearance issues is the most important.
- 2.** The next important use of the shims is to shim the caliper so it is perfectly parallel with the rotor. This may result in having more shims behind one of the fasteners to achieve this.
- 3.** With the potential tolerance stack up across all the components getting mounted to the spindle, it can be common to need to shim the caliper to make it parallel to the rotor. (What might be required on one side of the vehicle may differ on the opposing side.) *This is a critical step. If a caliper is mounted off parallel, the pistons will bind under load, and will not be able to retract properly.

Tip: Once you have the calipers where you think they should be, bleed the brake system. Once bled, loosen the caliper mounting bolts so the caliper can "float". Apply pressure to the brake pedal and if the caliper moves/twists, that is where the caliper wants to be under load. It is making itself parallel with the rotor. Shim the caliper off of the mounts so it stays there and tighten everything back up.