



AURA DOME™ ARCHITECTURE



Table of Contents

<u>Aura Dome All Models 1</u>	3	<u>½ Aura Shelter D6 H3</u>	<u>24</u>
<u>Aura Dome All Models 2</u>	<u>4</u>	<u>½ Aura Shelter D7 H3.5</u>	<u>25</u>
<u>Aura Dome All Models 3</u>	<u>5</u>	<u>½ Aura Shelter D8 H4</u>	<u>26</u>
<u>Aura Dome All Models 4</u>	<u>6</u>	<u>½ Aura Shelter D9 H4.5</u>	<u>27</u>
<u>Aura Dome All Models 5</u>	<u>7</u>	<u>½ Aura Shelter D10 H4.5</u>	<u>28</u>
<u>Aura Bubble D3 H2.4</u>	8	<u>⅓ Aura Shelter D5 H2.5</u>	29
<u>Aura Bubble D3.5 H2.4</u>	<u>9</u>	<u>⅓ Aura Shelter D6 H3</u>	<u>30</u>
		<u>⅓ Aura Shelter D7 H3.5</u>	<u>31</u>
<u>Aura Dome D3.6 H2.14</u>	10	<u>⅓ Aura Shelter D8 H4</u>	<u>32</u>
<u>Aura Dome D4 H2.38</u>	<u>11</u>	<u>⅓ Aura Shelter D9 H4.5</u>	<u>33</u>
<u>Aura Dome D4.5 H2.6</u>	<u>12</u>	<u>⅓ Aura Shelter D10 H5</u>	<u>34</u>
<u>Aura Dome D5 H3</u>	<u>13</u>		
<u>Aura Dome D6 H3</u>	<u>14</u>	<u>Aura Glamping D6 H3</u>	35
<u>Aura Dome D7 H3.5</u>	<u>15</u>	<u>Aura Glamping D7 H3.5</u>	<u>36</u>
<u>Aura Dome D7 H4.15</u>	<u>16</u>	<u>Aura Glamping D8 H4</u>	<u>37</u>
<u>Aura Dome D8 H3.86</u>	<u>17</u>	<u>Aura Glamping D9 H4.5</u>	<u>38</u>
<u>Aura Dome D9 H4.5</u>	<u>18</u>	<u>Aura Glamping D10 H5</u>	<u>39</u>
<u>Aura Dome D10 H5</u>	<u>19</u>		
<u>Aura Dome D11 H5.5</u>	<u>20</u>	<u>Aura Tunnel L24 W12</u>	40
<u>Aura Dome D12 H6</u>	<u>21</u>	<u>Aura Tunnel L4,87 W2,44</u>	<u>41</u>
		<u>Aura Tunnel L13 W5</u>	<u>42</u>
<u>½ Aura Shelter D4.5 H2.67</u>	22		
<u>½ Aura Shelter D5 H2.5</u>	<u>23</u>	<u>Contact</u>	43

Aura Dome All Models 1

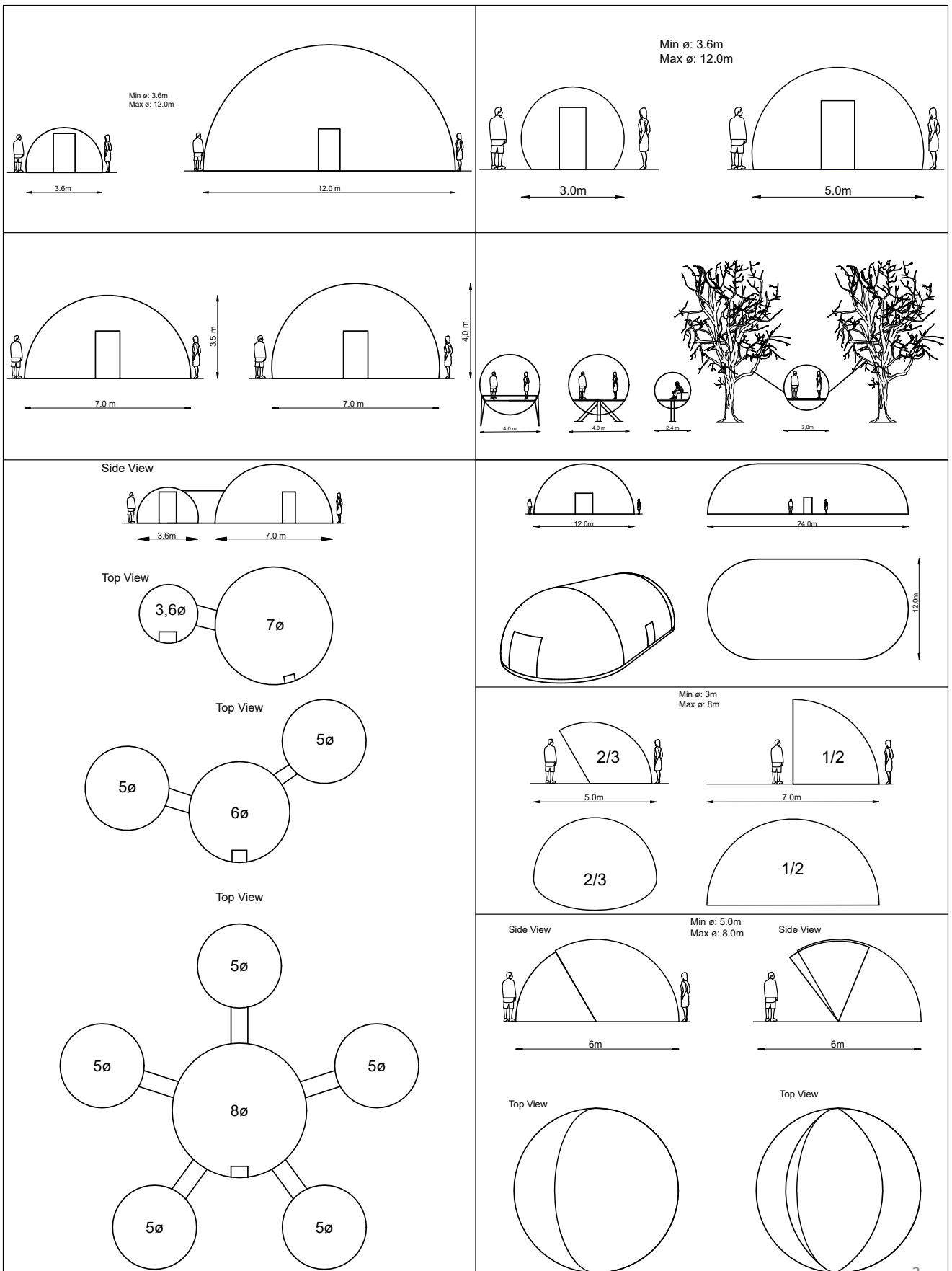

Aura Dome All Models 2

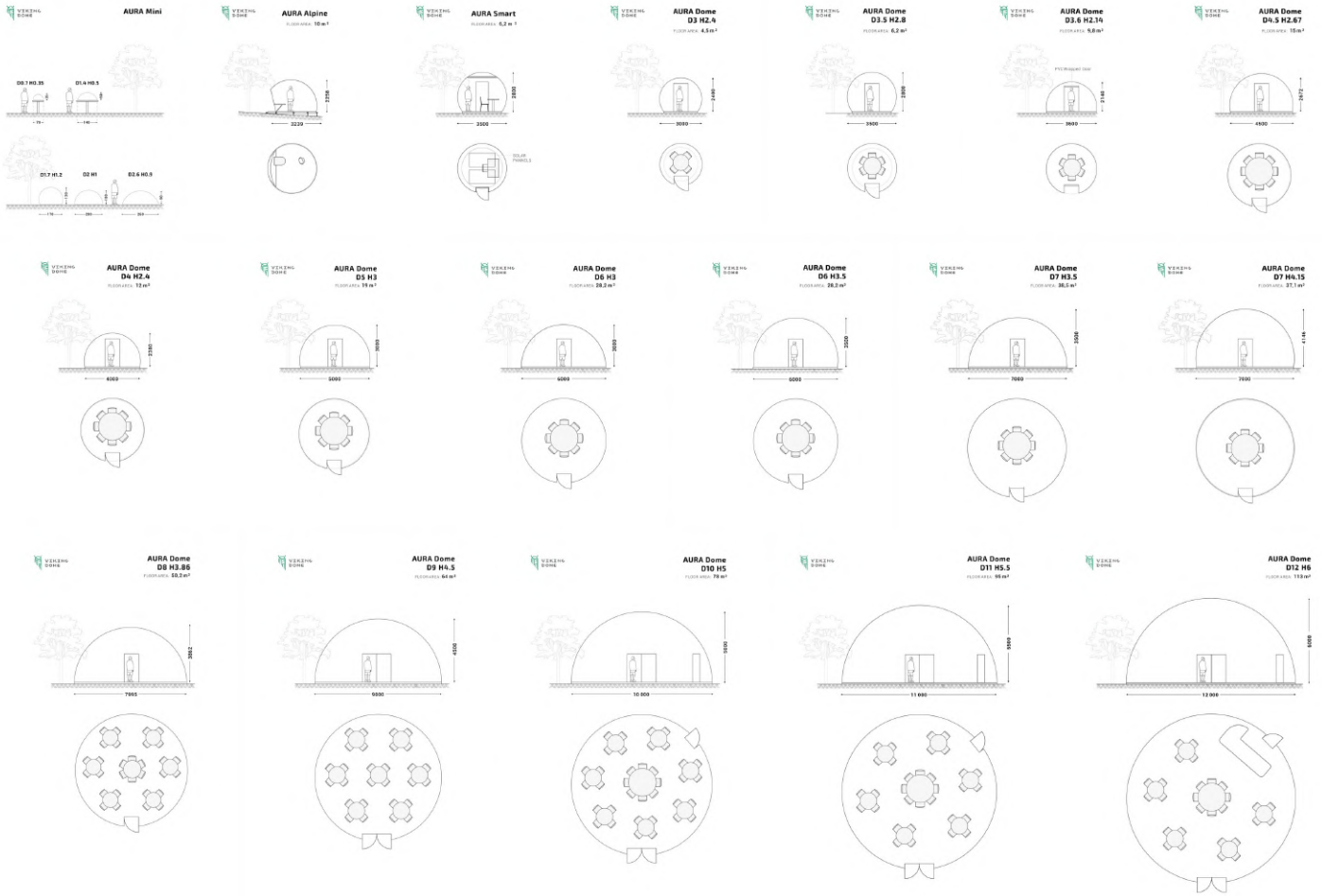

Aura Dome All Models 3

AURA Dome PRO

SIZE: 3; 3.5; 3.6; 4; 4.5; 5; 6; 7; 8; 9; 10; 11; 12 m

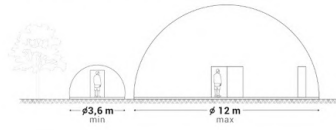

AURA Dome Event

SIZE: 3.6; 4; 4.5 m

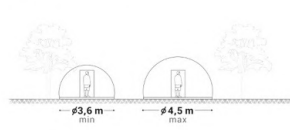

AURA Dome Shapes

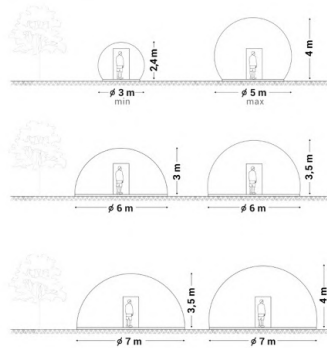

AURA Sphere

SIZE: 2.4 m

CAPTURE OPTIONS: A1 - ON LEG



INTERIOR
A: Sleeping pod from 5 parts
B: Battery / Control



FIXING LEG FOR
AURA SPHERE

CAPTURE OPTIONS: A3 - ON POLE A4 - TRIPOD

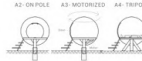

DELIVERY PACKAGE



B - WITH SIDE HOLDER

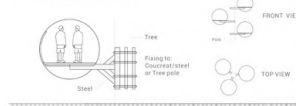

AURA Tunnel

AURA Tunnel PRO
SIZE: 3-12/ 6; 12; 18; 24 m

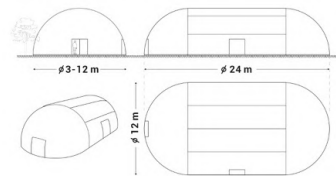

AURA Tunnel Event
SIZE: 3-6/ 6; 12; 18; 24 m

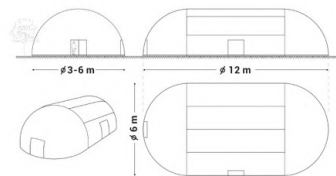

C - CABLE LIFTER

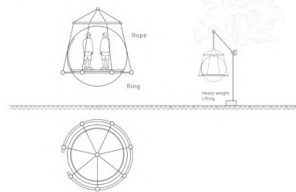

AURA Shelter

AURA Shelter PRO
SIZE: 3.6; 4; 4.5; 5; 6; 7; 8; 9; 10; 11; 12 m

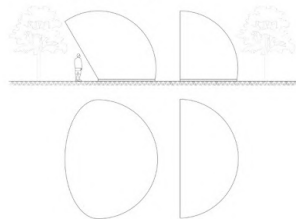

AURA Shelter Event
SIZE: 3.6; 4; 5; 6; 7 m

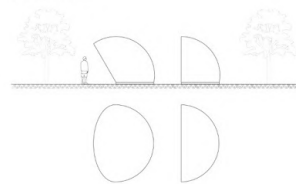

AURA Dome Connected

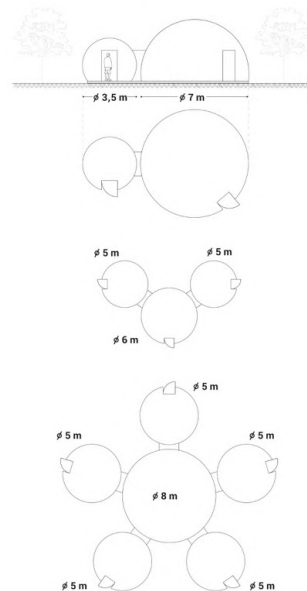



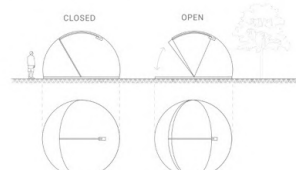

AURA Shelter PRO Motorized

SIZE: 5; 6 m

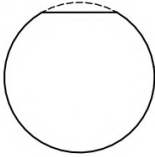
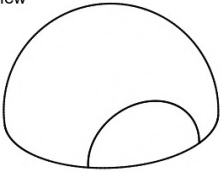
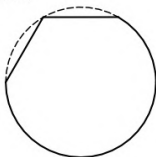
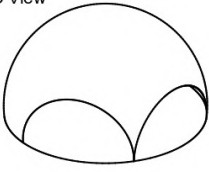
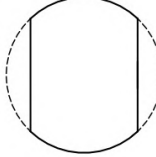
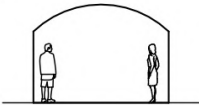
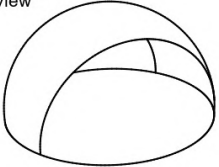
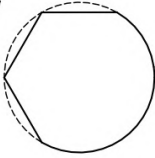
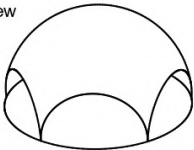
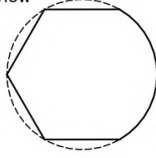
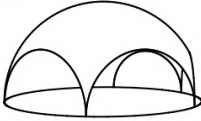
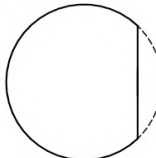
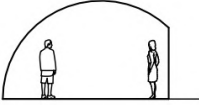
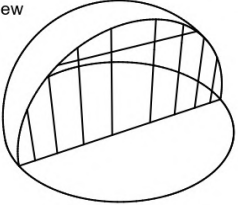
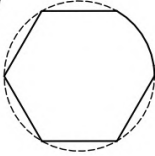
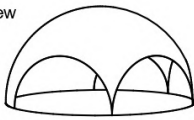
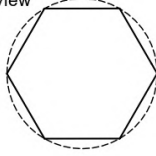

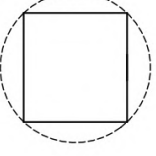
Aura Dome All Models 4

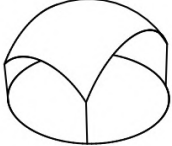
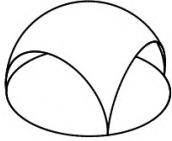
<p>Top View</p>  <p>3D View</p> 	<p>Top View</p>  <p>3D View</p> 	<p>Top View</p>  <p>Front View</p> 	<p>3D View</p> 
<p>Top View</p>  <p>3D View</p> 	<p>Top View</p>  <p>3D View</p> 	<p>Top View</p>  <p>Front View</p> 	<p>3D View</p> 
<p>Top View</p>  <p>3D View</p> 	<p>Top View</p>  <p>3D View</p> 	<p>Top View</p>  <p>Front View</p> 	<p>3D View</p>  <p>3D View</p> 

Aura Dome All Models 5



Aura Bubble 3m Diameter 2,4m Height

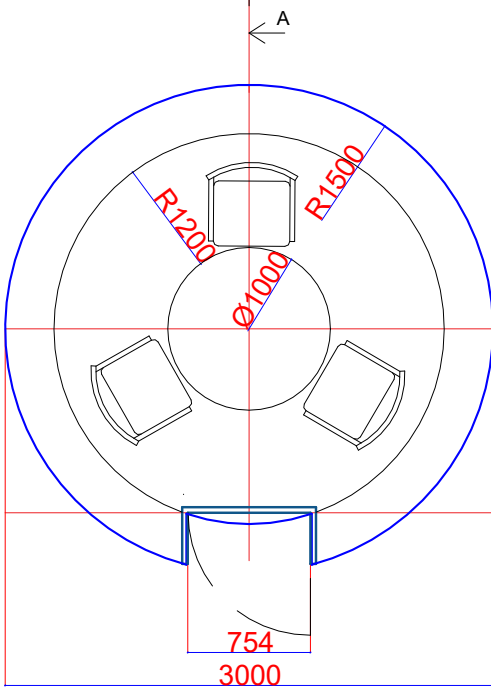
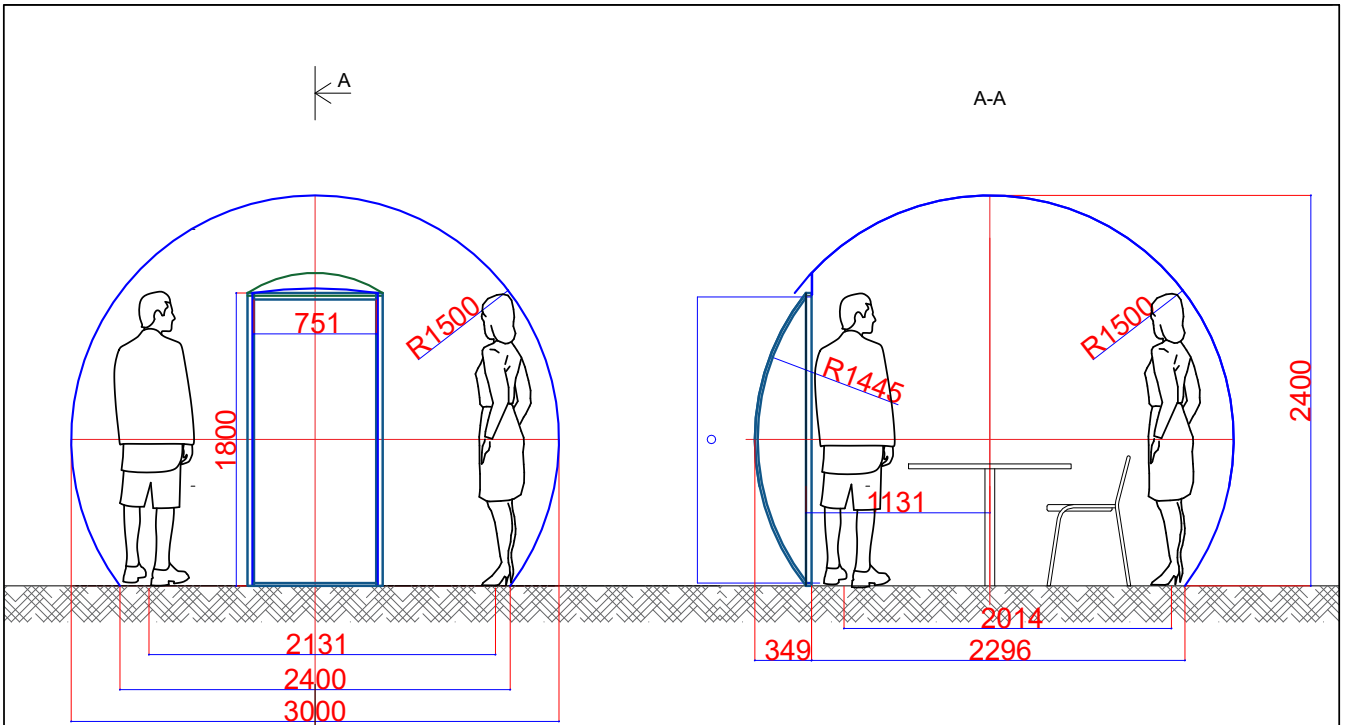

Sphere surface- 22 m²
 Floor area- 4,5 m²

Internal volume- 12 m³
 Weight- 100 kg

Aura Bubble 3,5m Diameter 2,8m Height

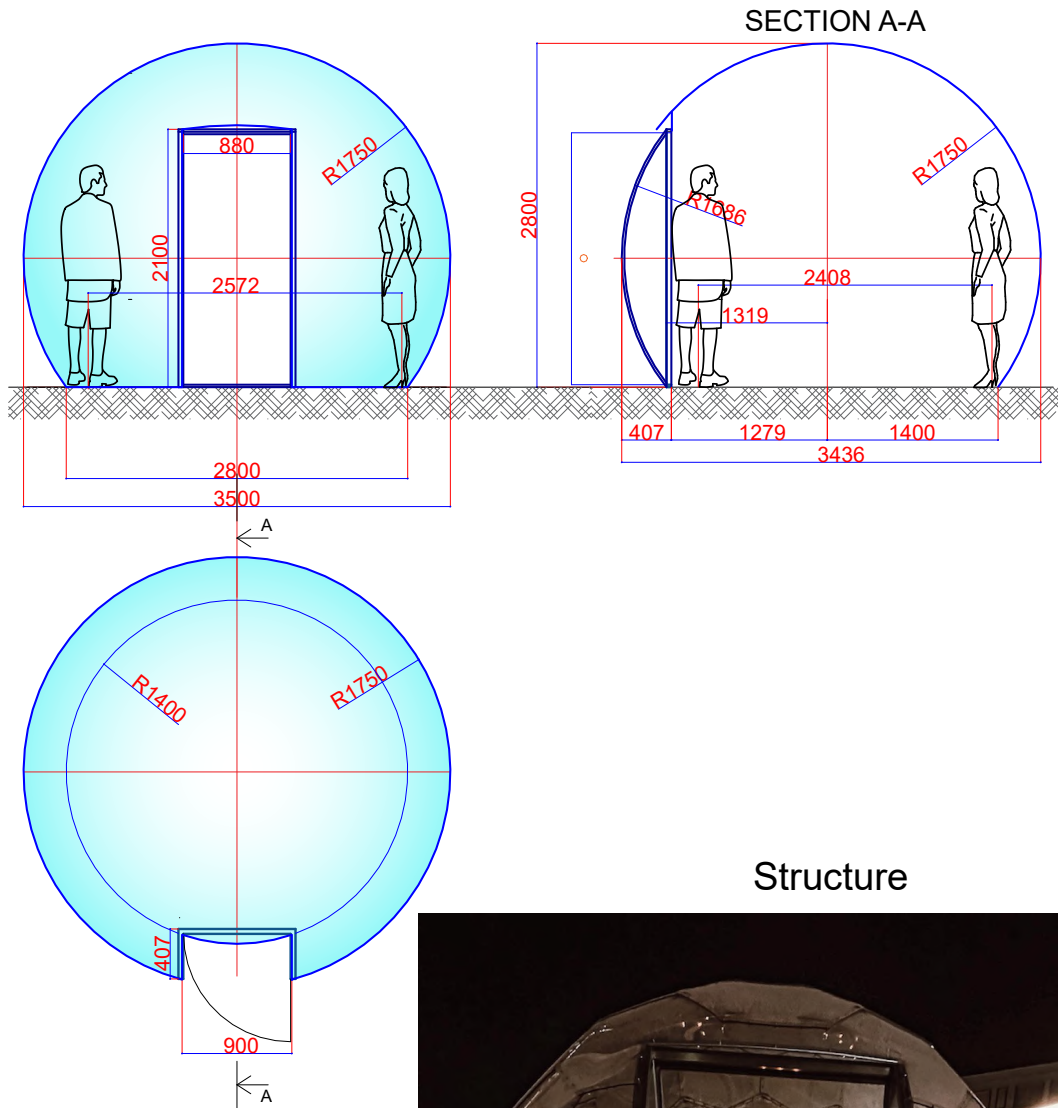

Structure



Sphere surface- 30,8 m²

Floor area- 5,8 m²

Internal volume- 20 m³

Weight- 235 kg

Aura Dome 3,6m Diameter 2,14m Height

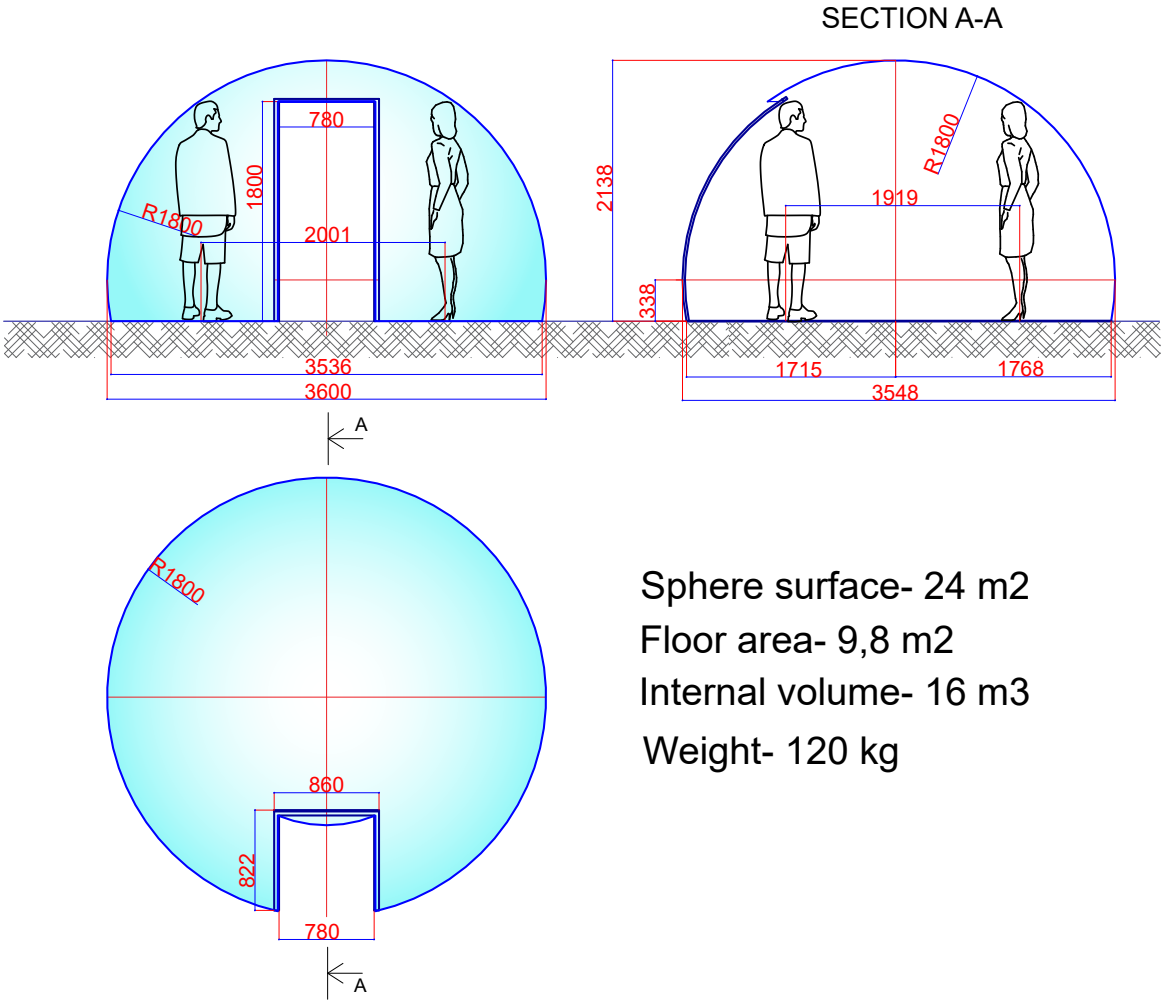

Sphere surface- 24 m²
 Floor area- 9,8 m²
 Internal volume- 16 m³
 Weight- 120 kg

Structure



Aura Dome 4m Diameter 2,38m Height

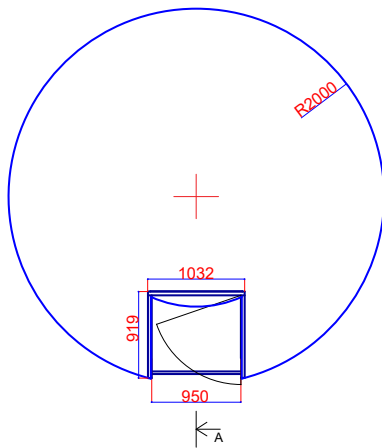
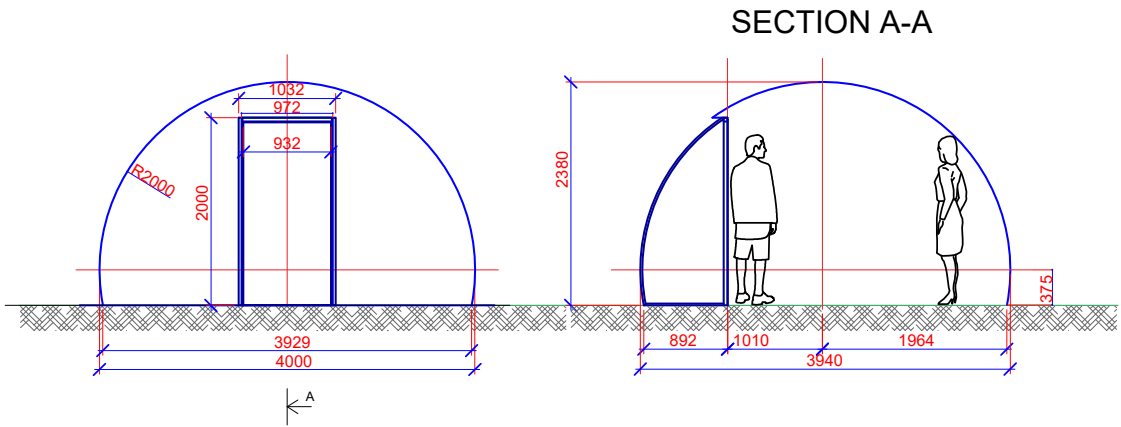

Sphere surface- 30 m²
Floor area- 12 m²
Internal volume- 20 m³
Weight- 170 kg

Structure



Aura Dome

Aura Dome 4,5m Diameter 2,6m Height

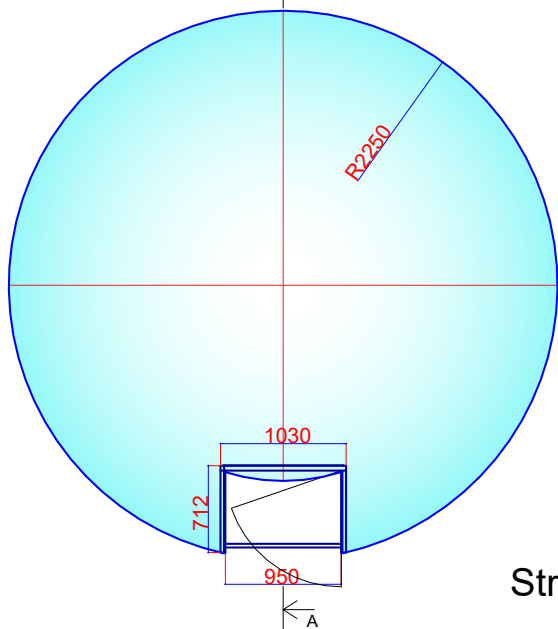
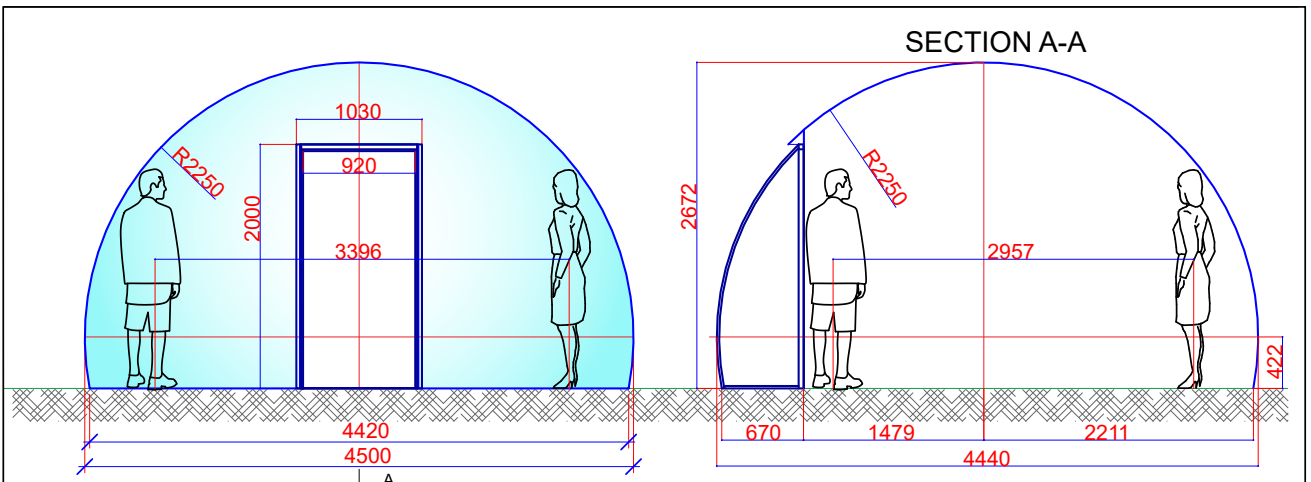

Sphere surface- 38 m²
 Floor area- 15 m²
 Internal volume- 30 m³
 Weight- 265 kg

Structure



Aura Dome 5m Diameter 3m Height

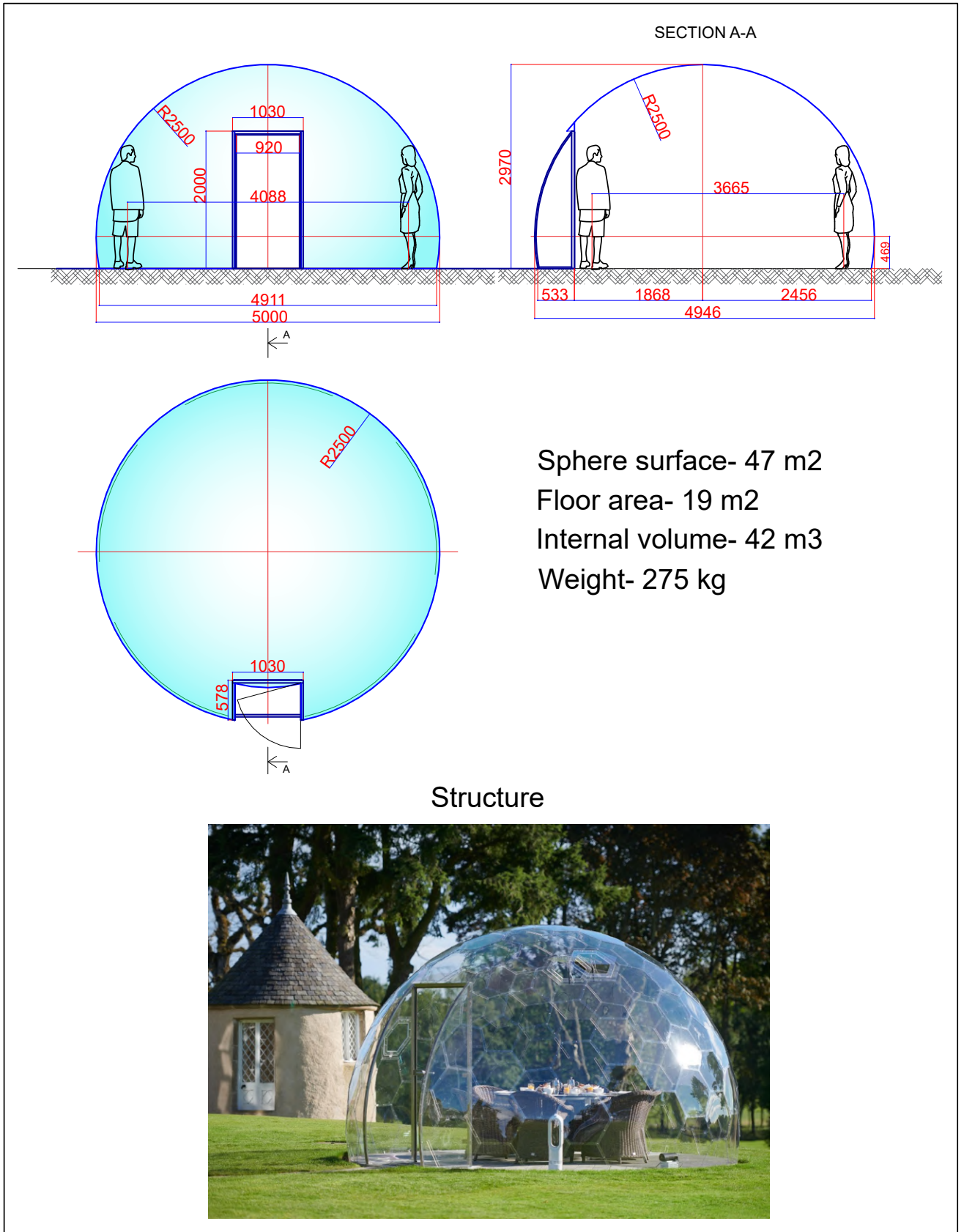

Aura Dome 6m Diameter 3m Height

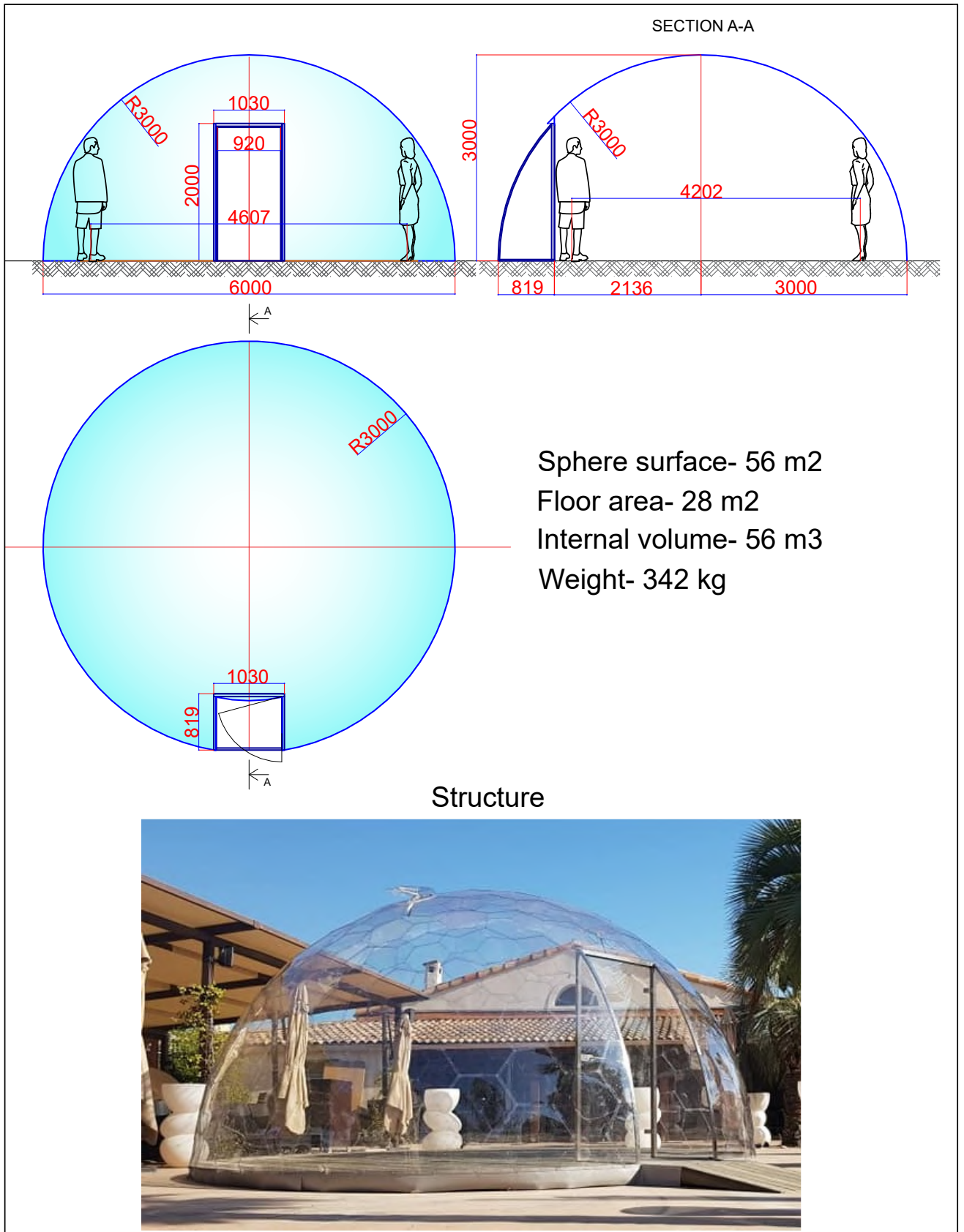

Aura Dome 7m Diameter 3,5m Height

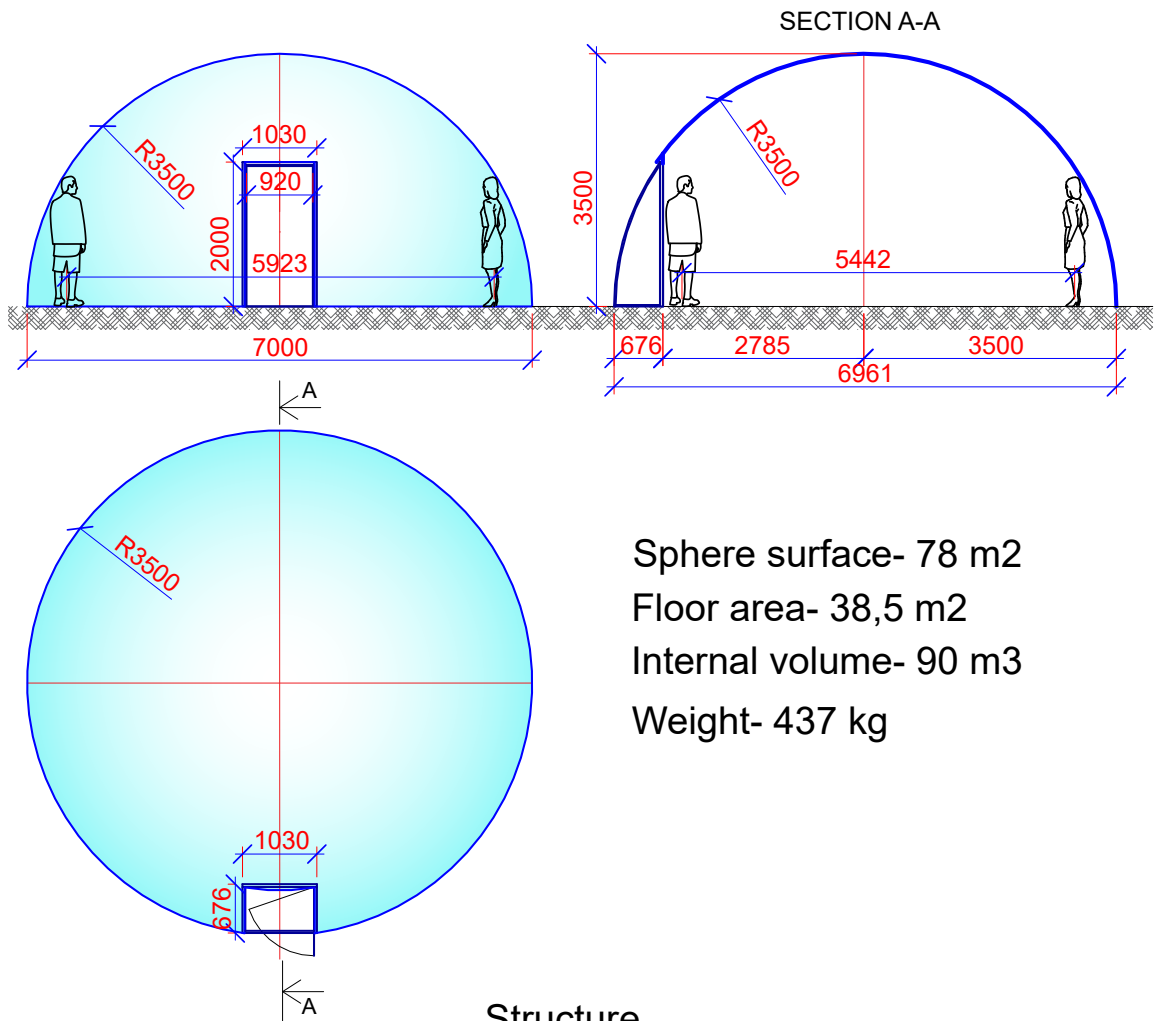

Sphere surface- 78 m²
Floor area- 38,5 m²
Internal volume- 90 m³
Weight- 437 kg

Structure



Aura Dome 7m Diameter 4,15m Height

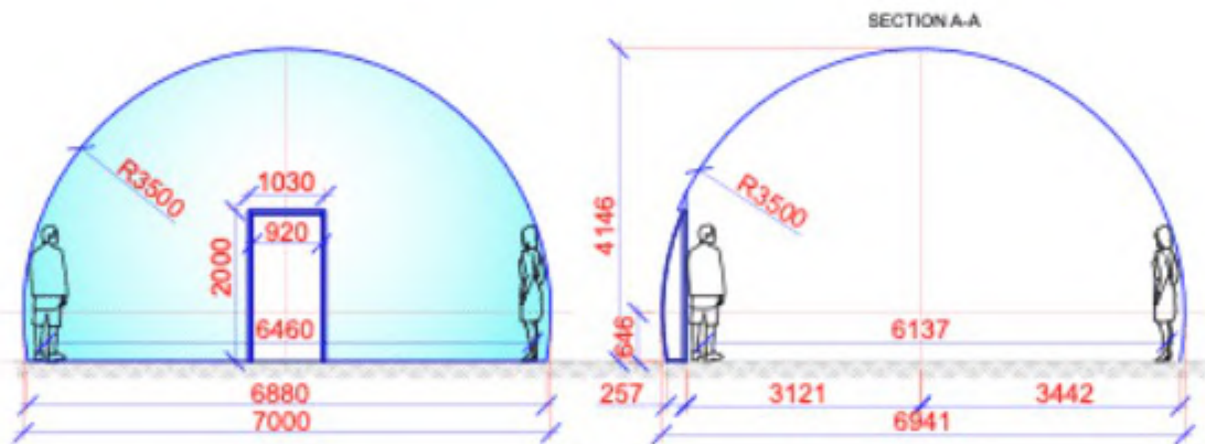

Sphere surface- 91 m²
Floor area- 37 m²
Internal volume-114 m³
Weight- 624 kg

Structure



Aura Dome 8m Diameter 3,86m Height

SECTION A-A

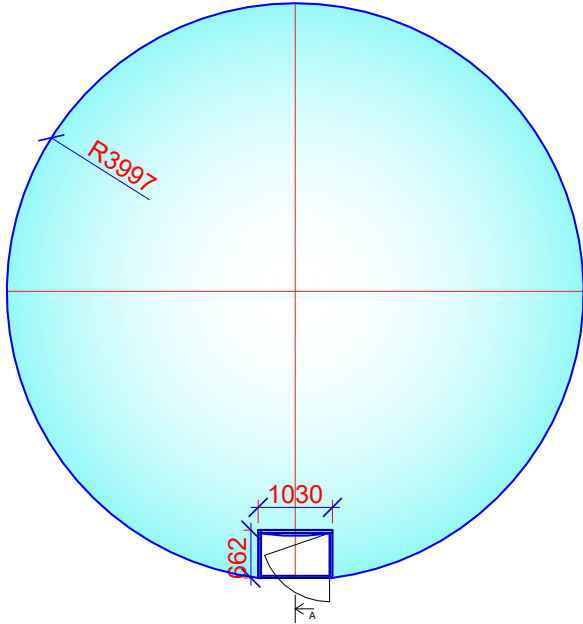
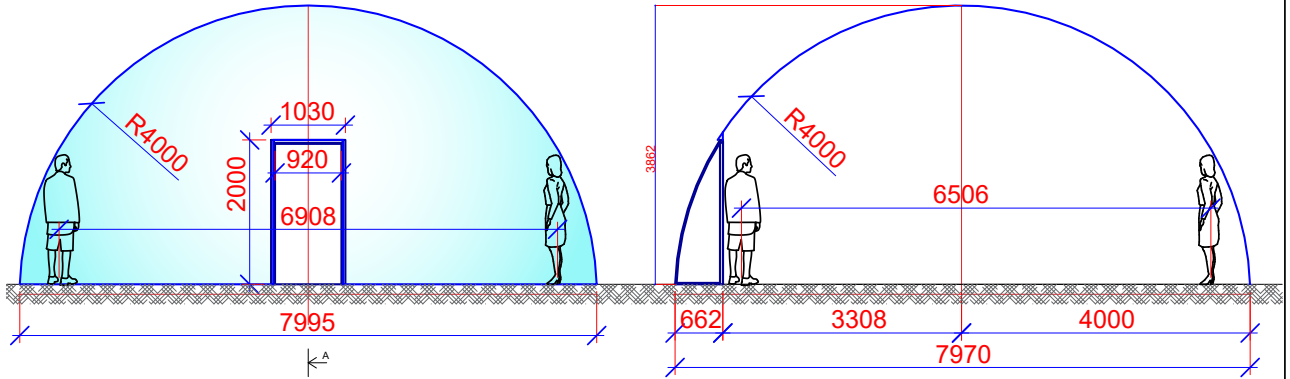

Sphere surface- 97 m²
Floor area-50 m²
Internal volume-127 m³
Weight- 660 kg

Structure



Aura Dome 9m Diameter 4,5m Height

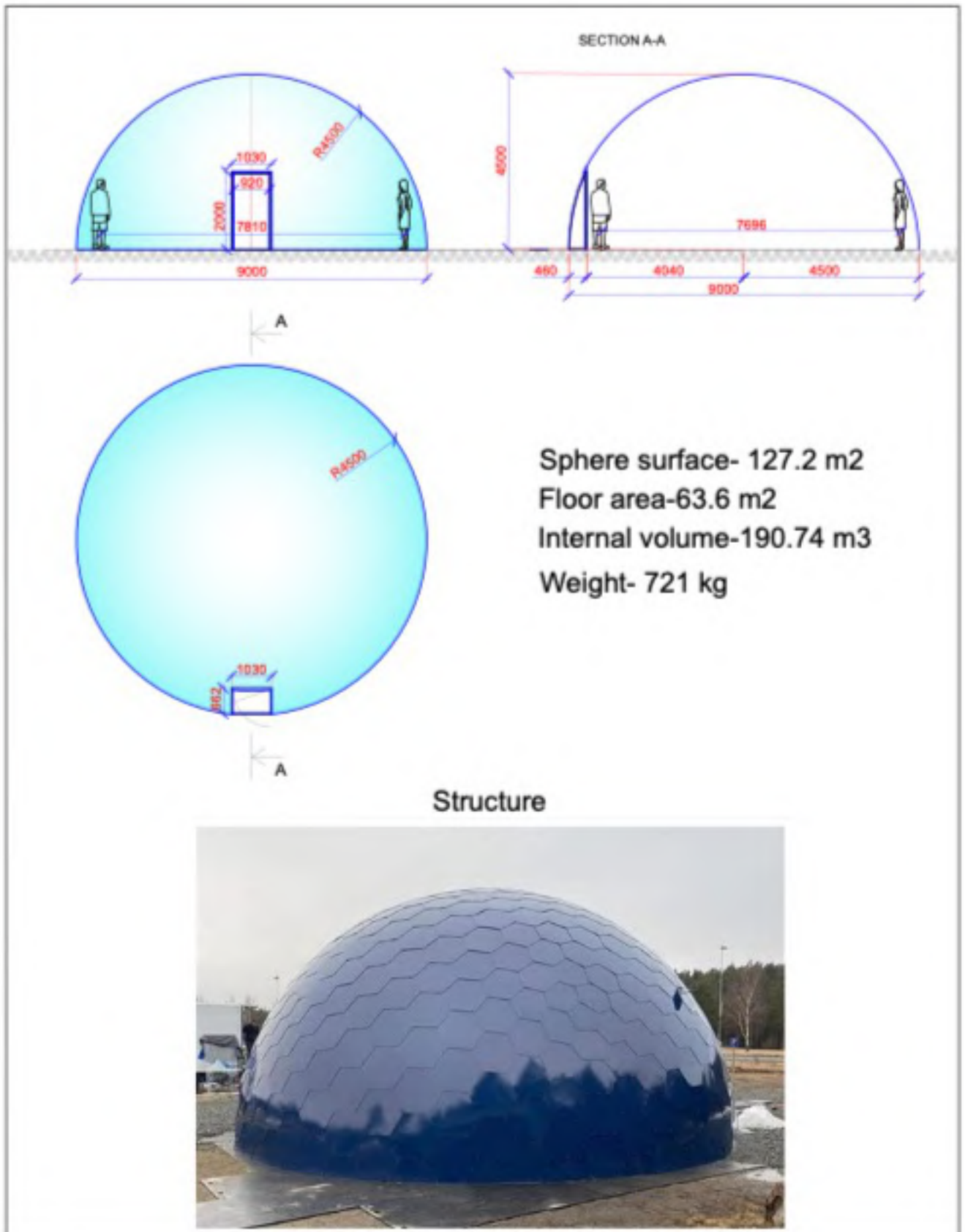

Aura Dome 10m Diameter 5m Height

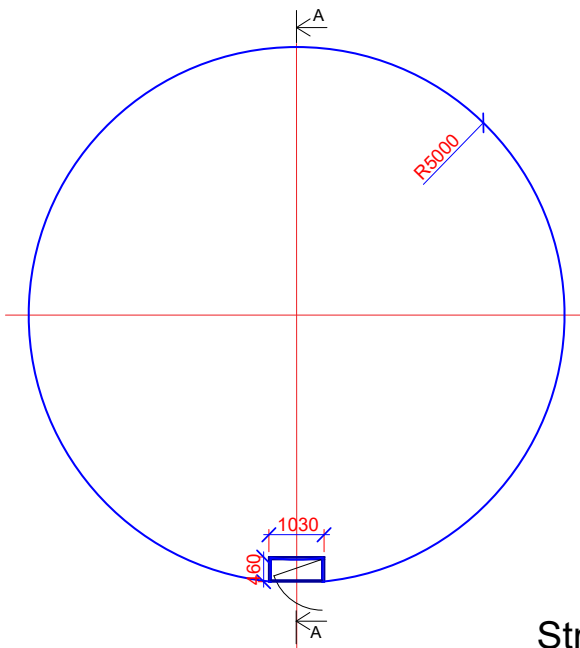
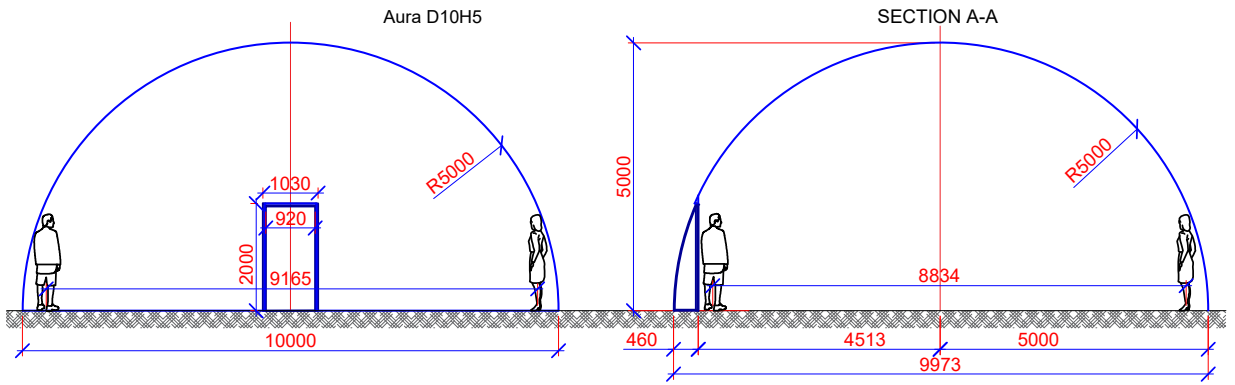

Sphere surface- 157 m²
Floor area-78 m²
Internal volume-262 m³
Weight- 1300 kg

Structure



Aura Dome 11m Diameter 5,5m Height

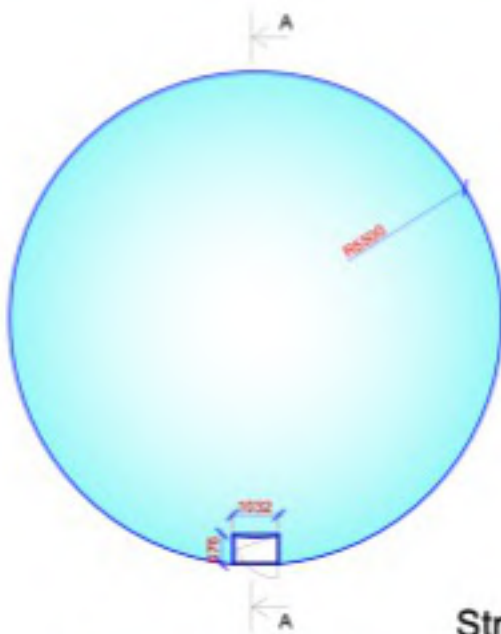
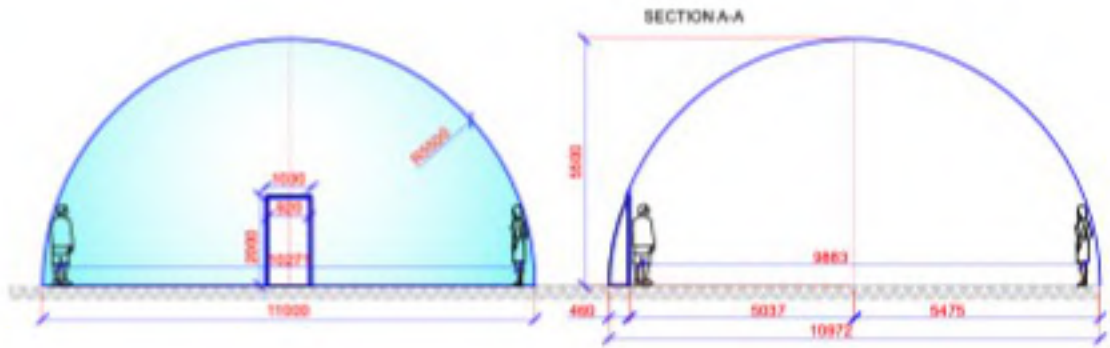

Sphere surface- 190 m²
Floor area-95 m²
Internal volume-348.26 m³
Weight- 1555 kg

Structure



Aura Dome 12m Diameter 6m Height

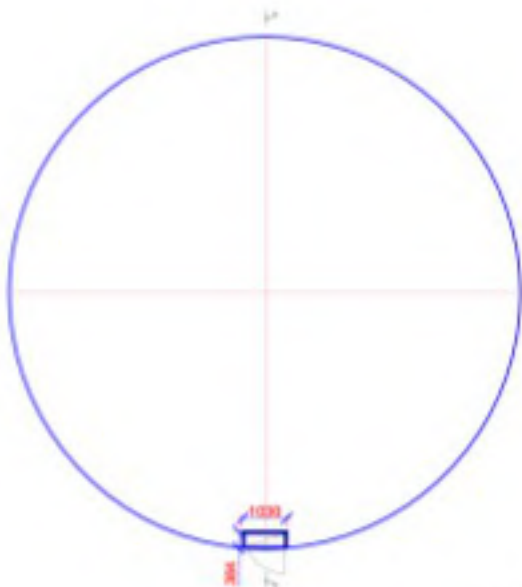
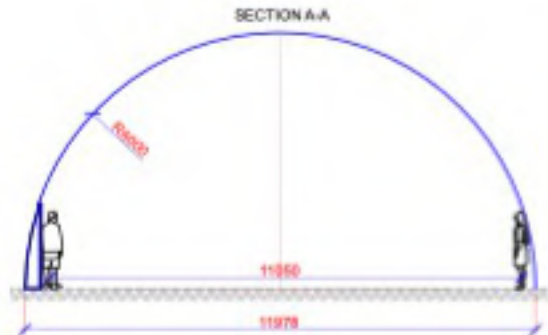
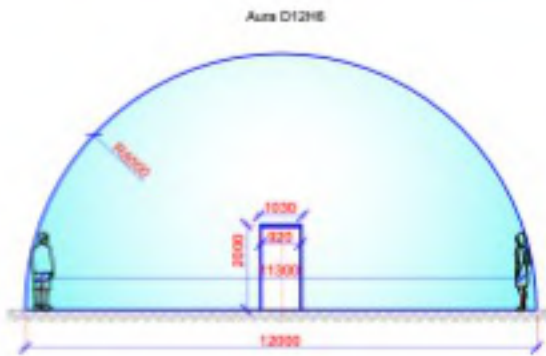

Sphere surface- 226 m²
Floor area-113 m²
Internal volume-452 m³
Weight- 2000 kg

Structure



½ Aura Shelter 4.5m Diameter 2,67m Height

Aura D4.5H2.67x1/2

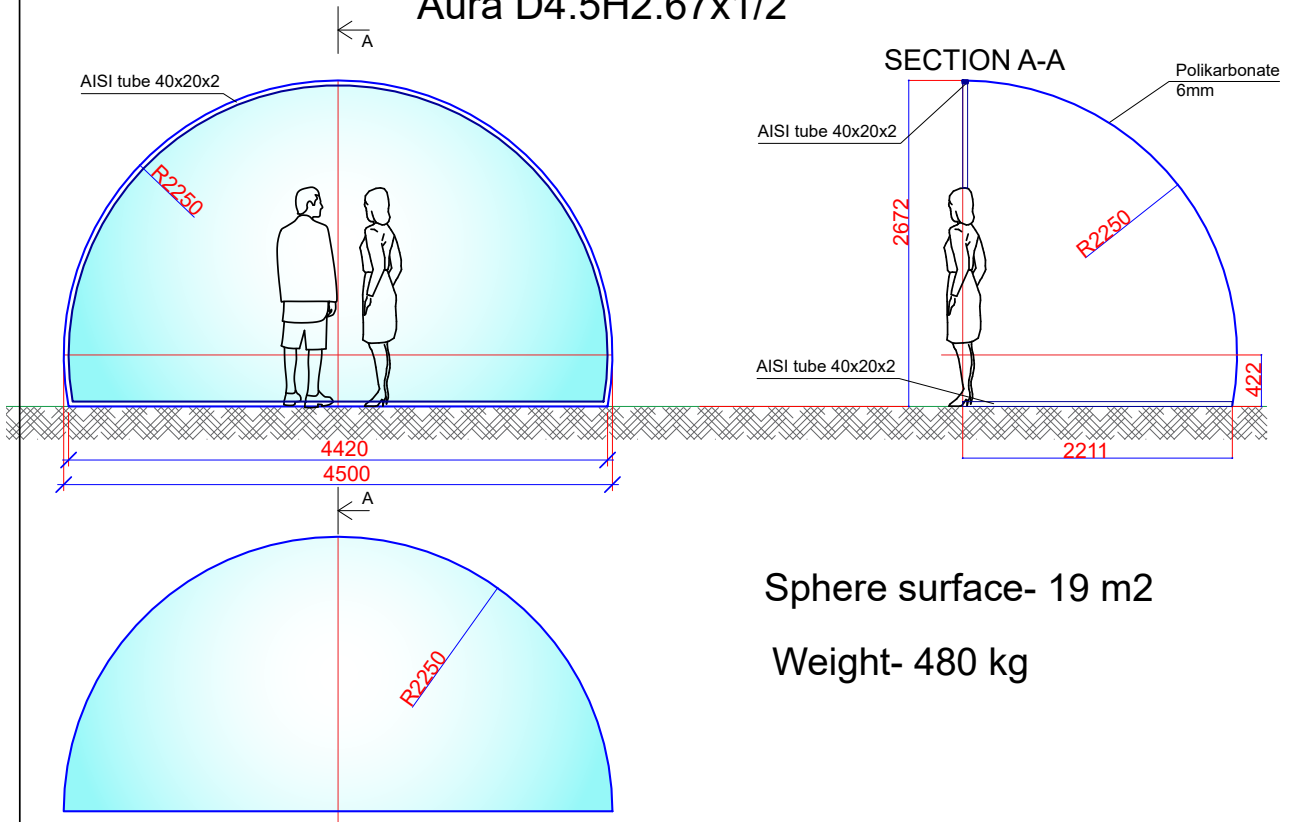

Sphere surface- 19 m²

Weight- 480 kg

Structure

Aura D4,5H2,67F12T3
in Japan



½ Aura Shelter 5m Diameter 2,5m Height

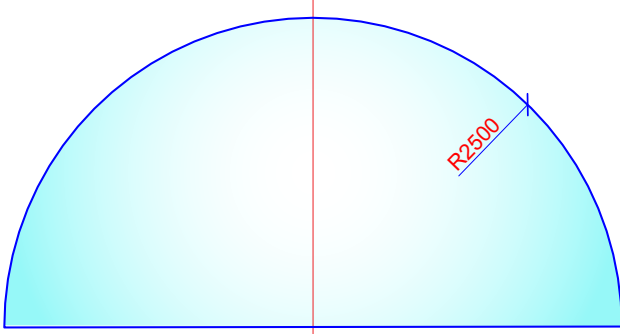
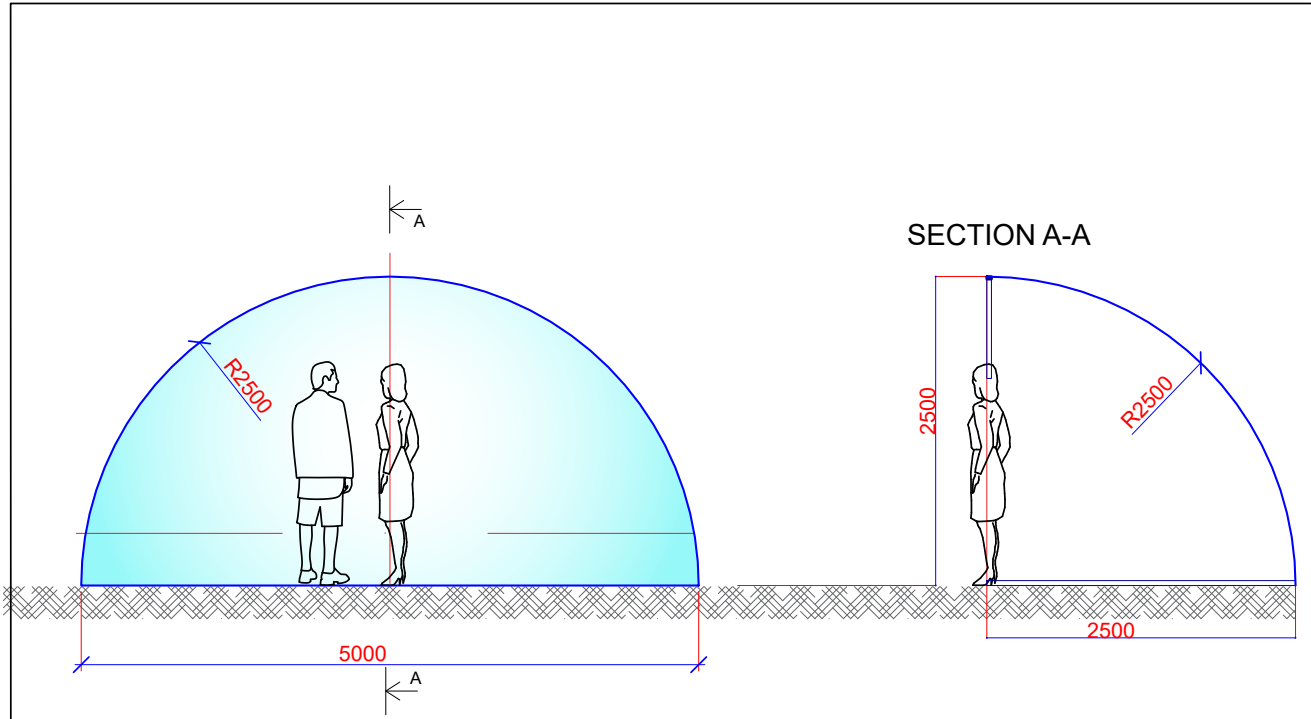

Sphere surface- 19.65 m²
Floor area- 9.8 m²
Weight- 93 kg

Structure



½ Aura Shelter 6m Diameter 3m Height

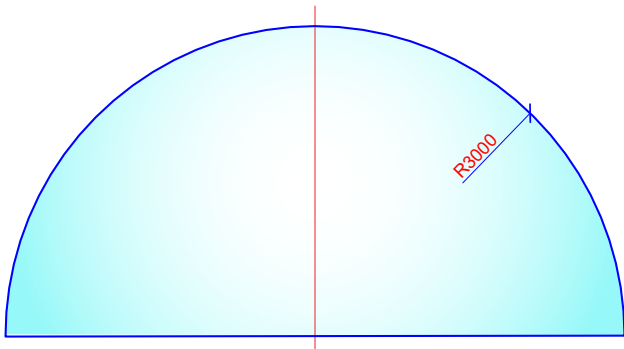
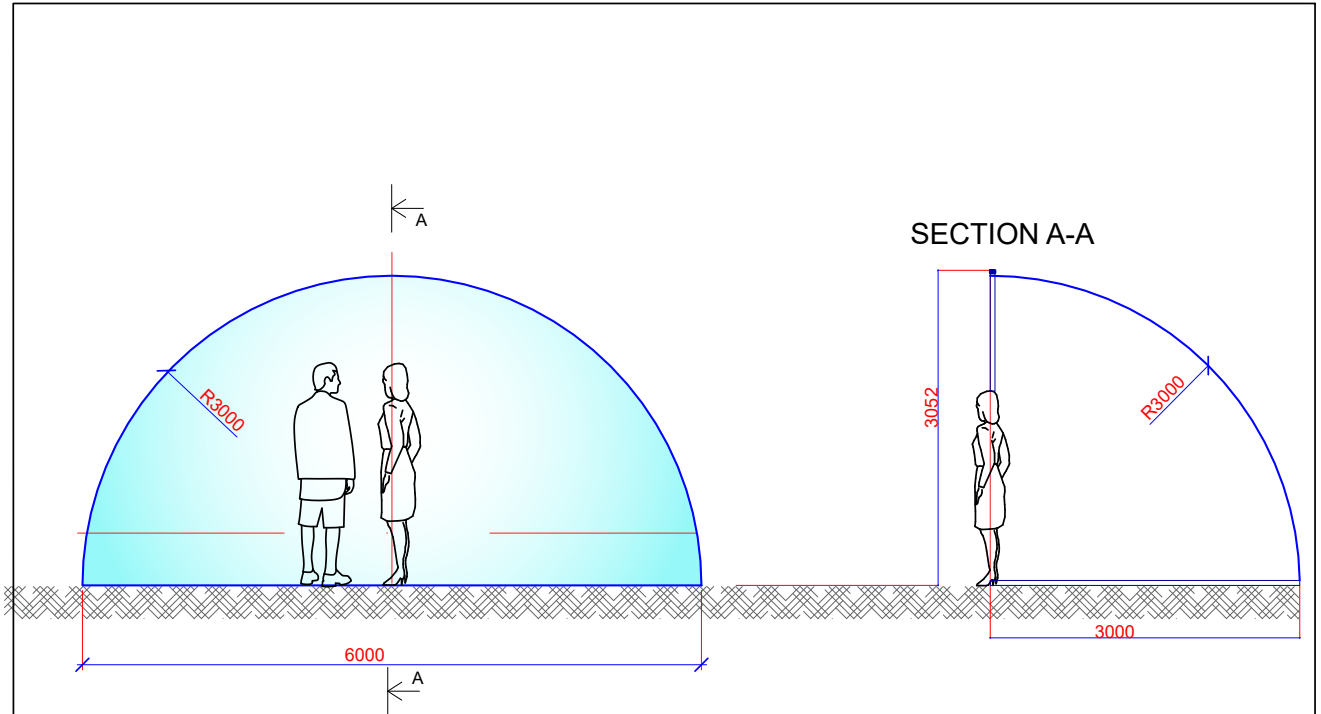

Sphere surface- 28.25 m²
Floor area- 14.15 m²
Weight- 134.5 kg

Structure



½ Aura Shelter 7m Diameter 3,5m Height

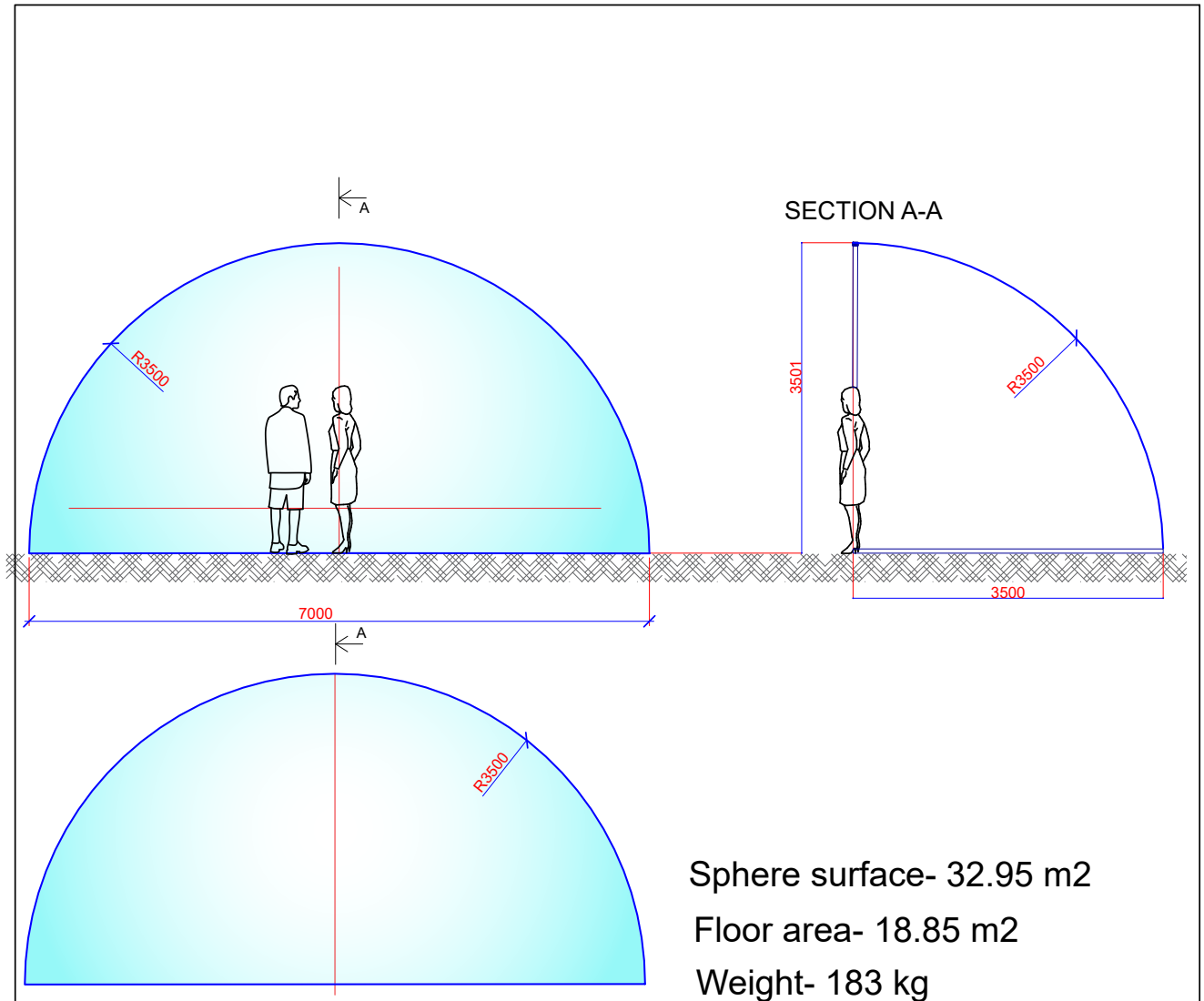

Structure



½ Aura Shelter 8m Diameter 4m Height

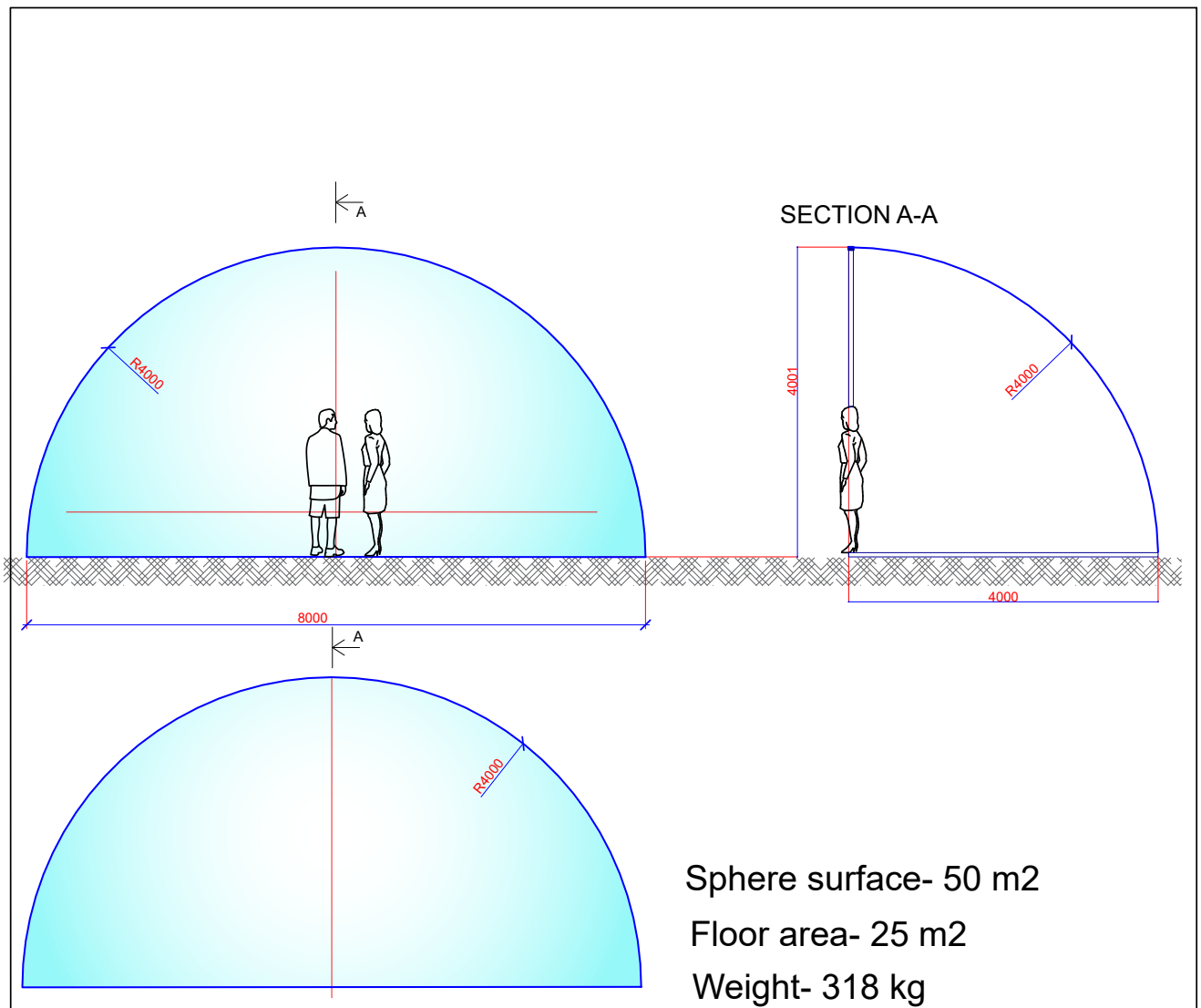

Structure



½ Aura Shelter 9m Diameter 4.5m Height

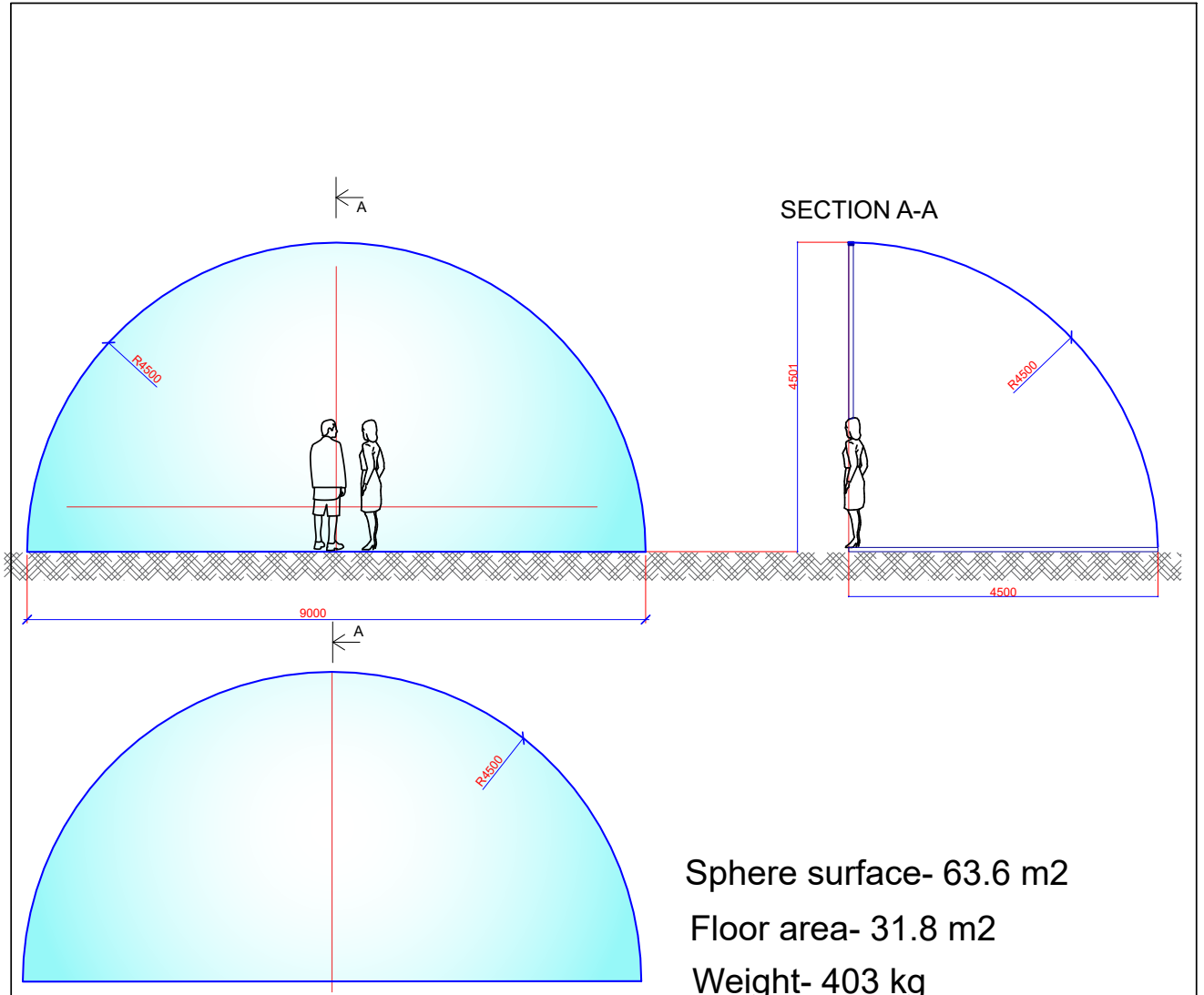

Structure



½ Aura Shelter 10m Diameter 5m Height

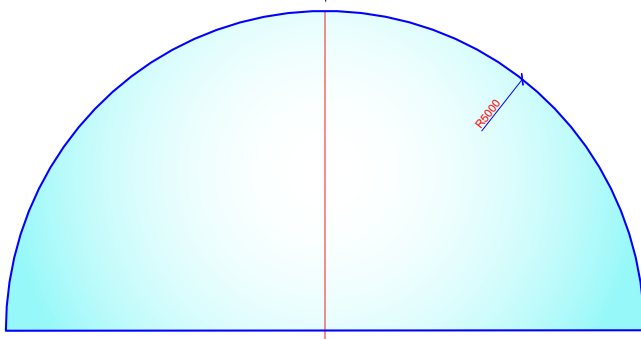
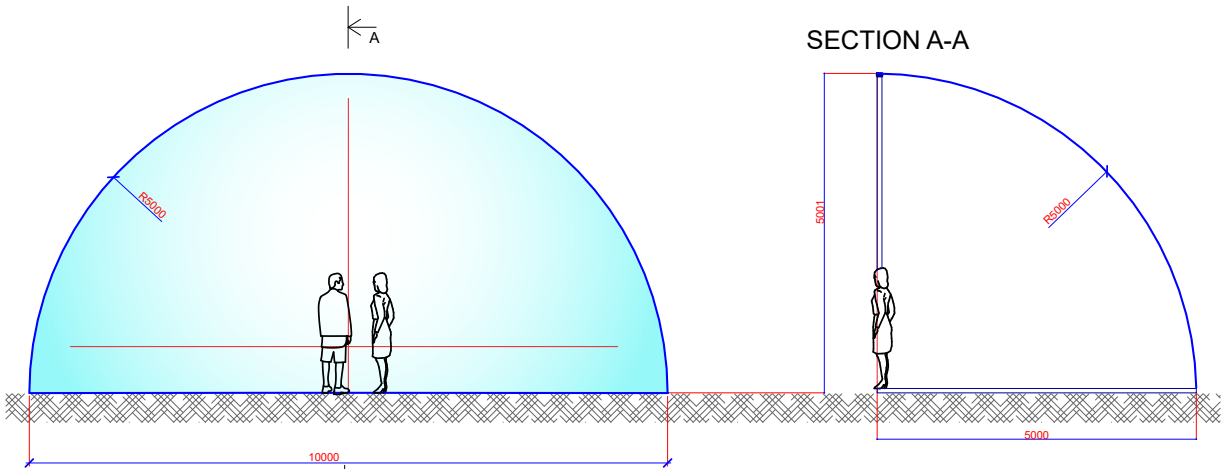

Sphere surface- 78.5 m²

Floor area- 39.25 m²

Weight- 746 kg

Structure



2/3 Aura Shelter 5m Diameter 2,5m Height

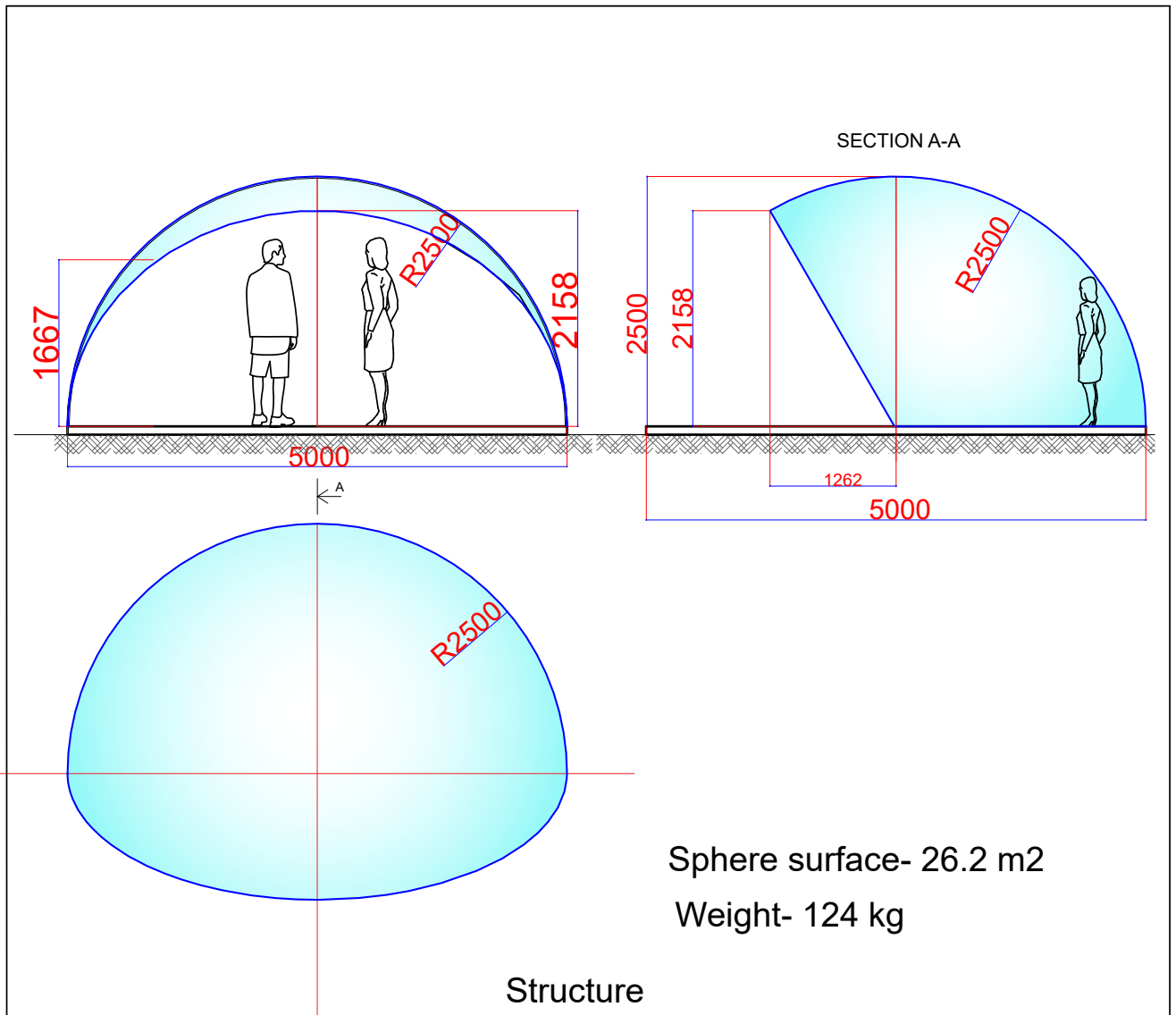

2/3 Aura Shelter 6m Diameter 3m Height

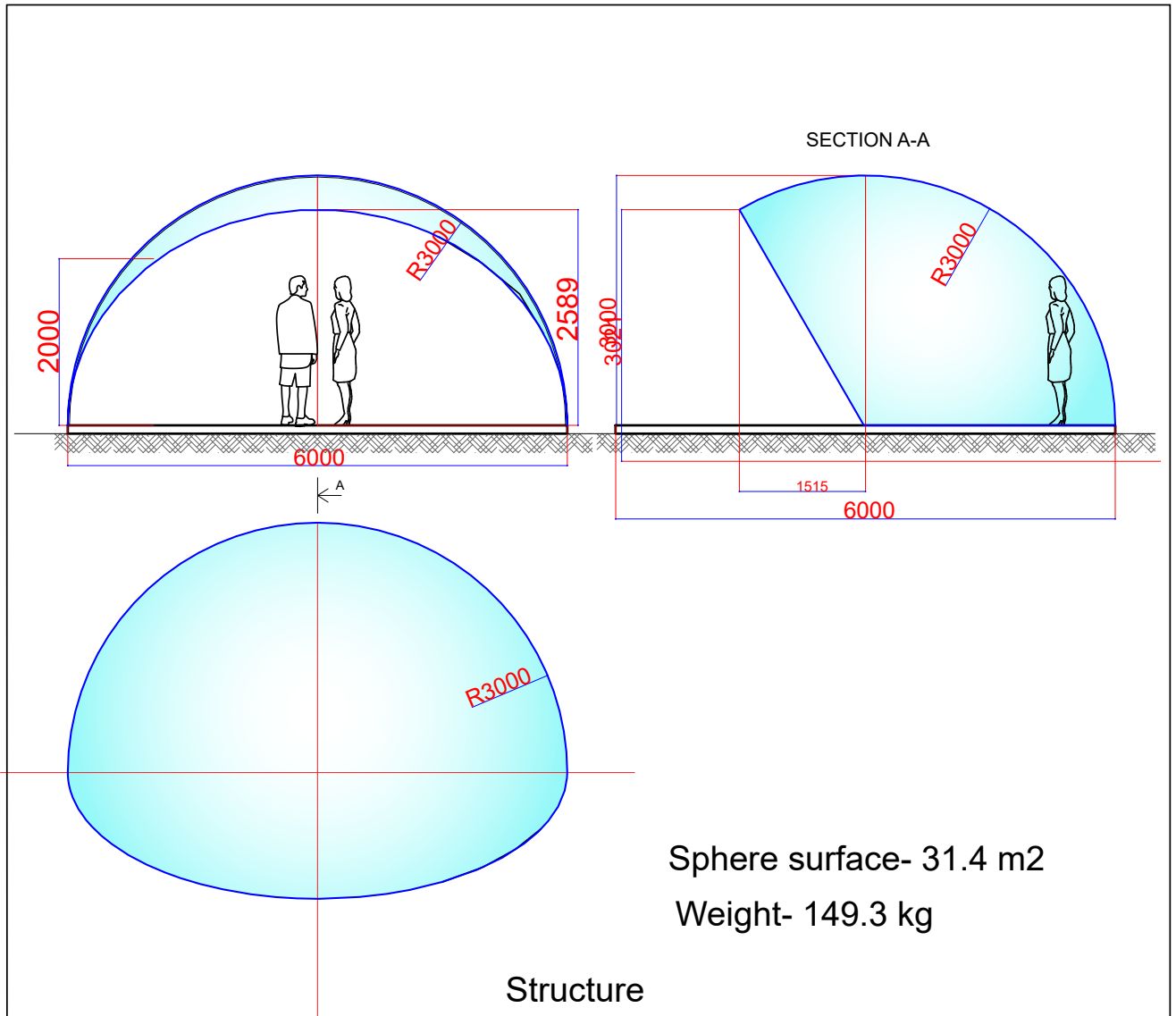

2/3 Aura Shelter 7m Diameter 3.5m Height

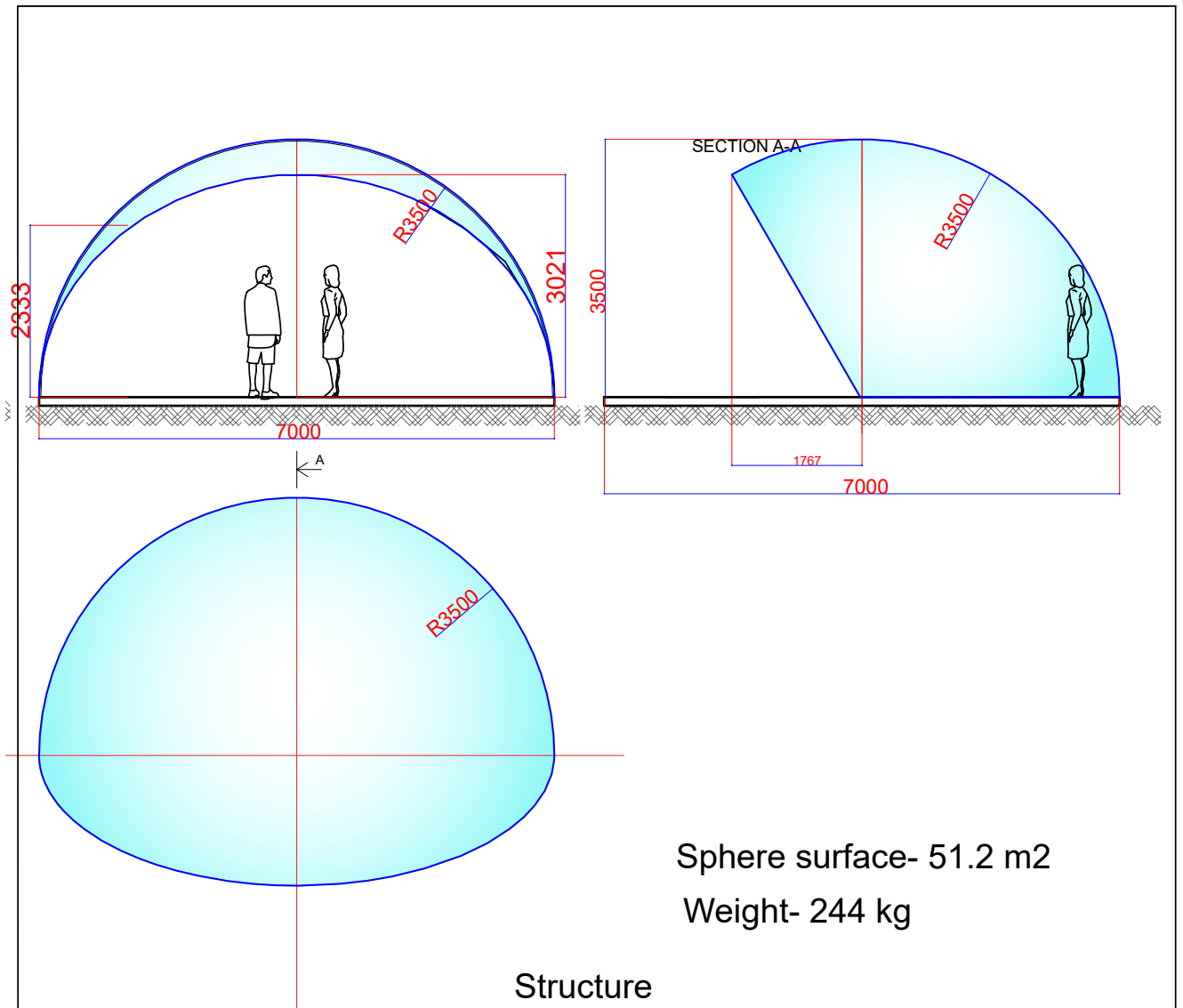

2/3 Aura Shelter 8m Diameter 4m Height

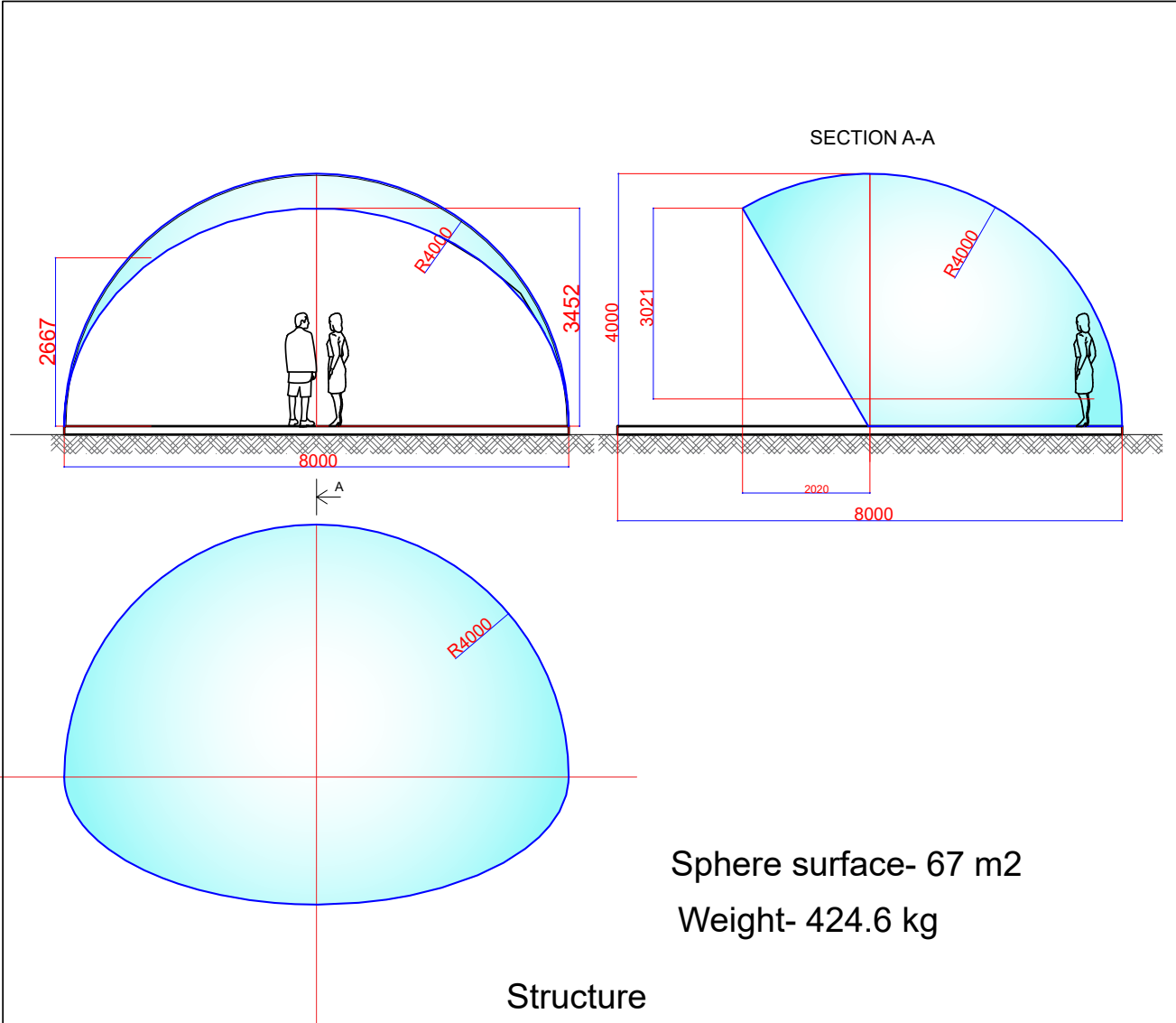

Sphere surface- 67 m2
Weight- 424.6 kg

Structure



2/3 Aura Shelter 9m Diameter 4.5m Height

SECTION A-A

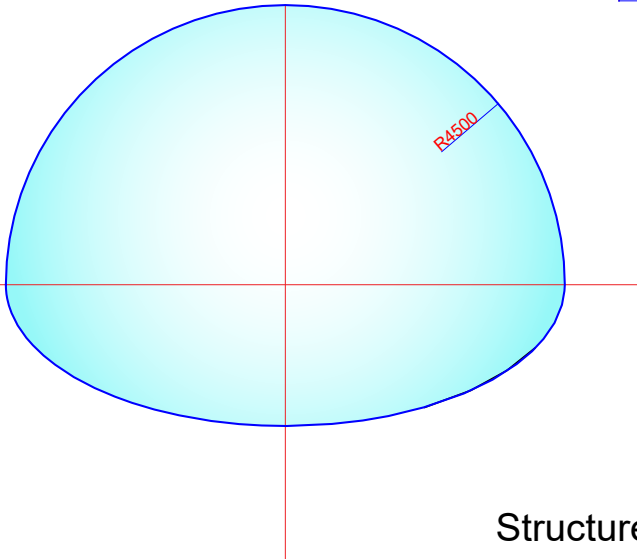
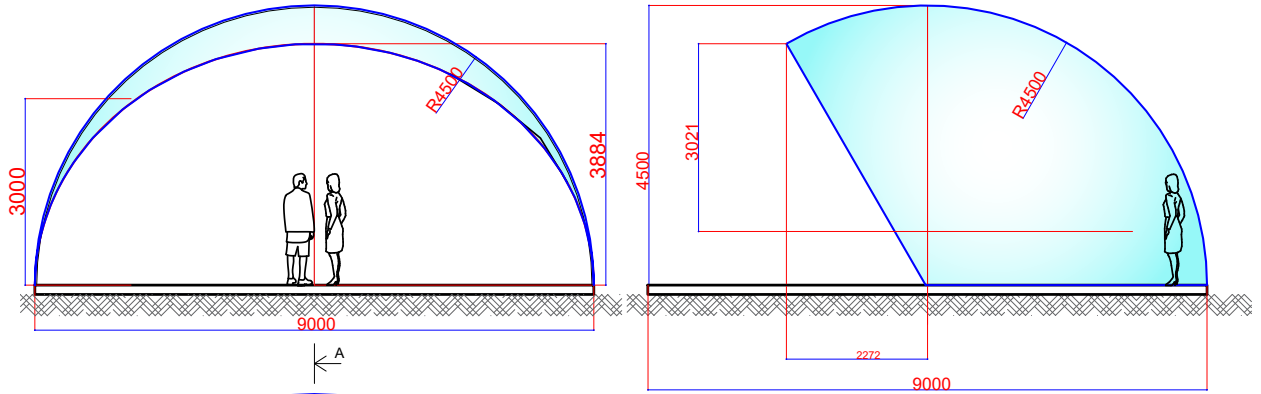

Sphere surface- 75 m²

Weight- 477kg

Structure



2/3 Aura Shelter 10m Diameter 5m Height

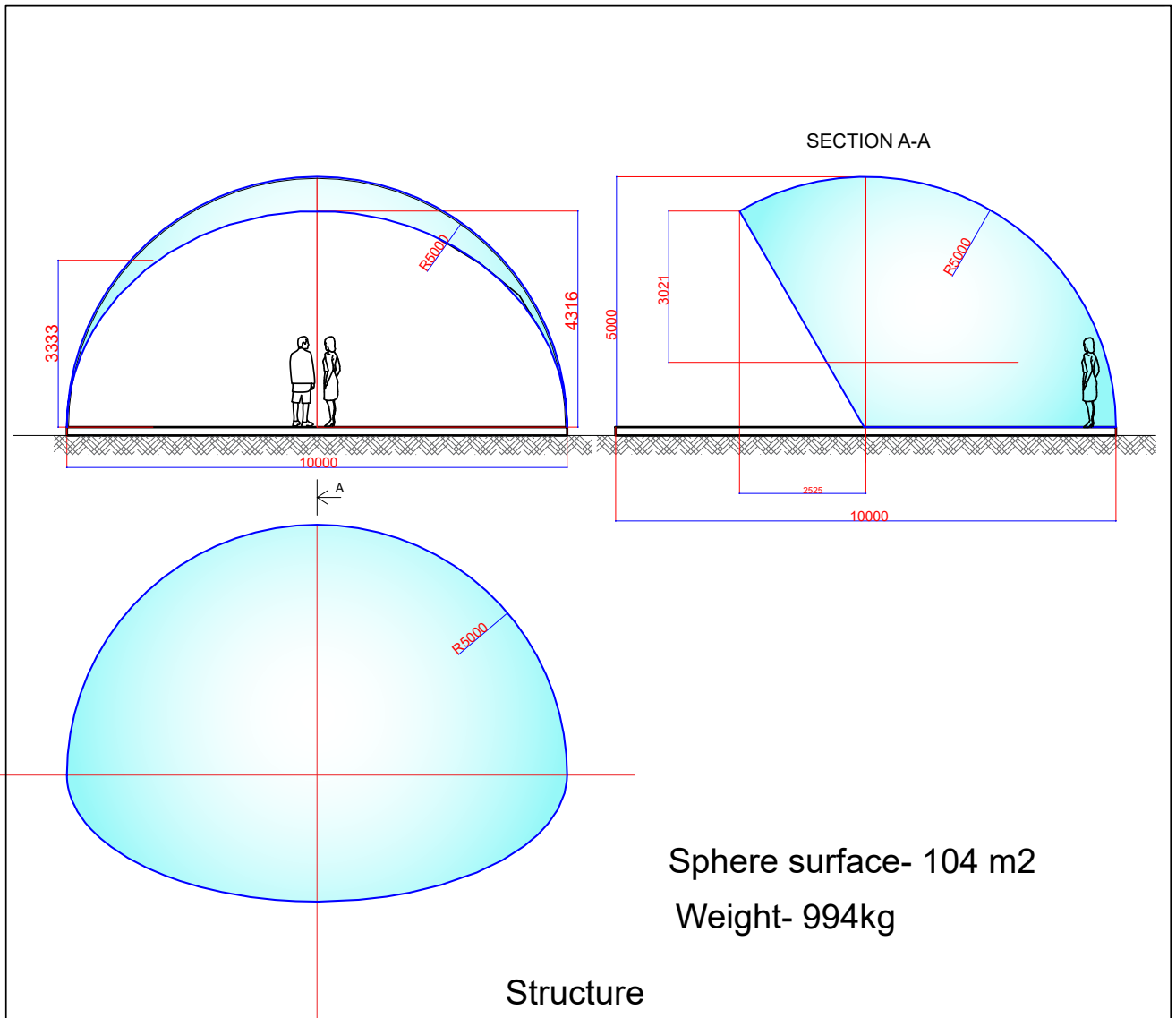

Aura Glamping 6m Diameter 3m Height

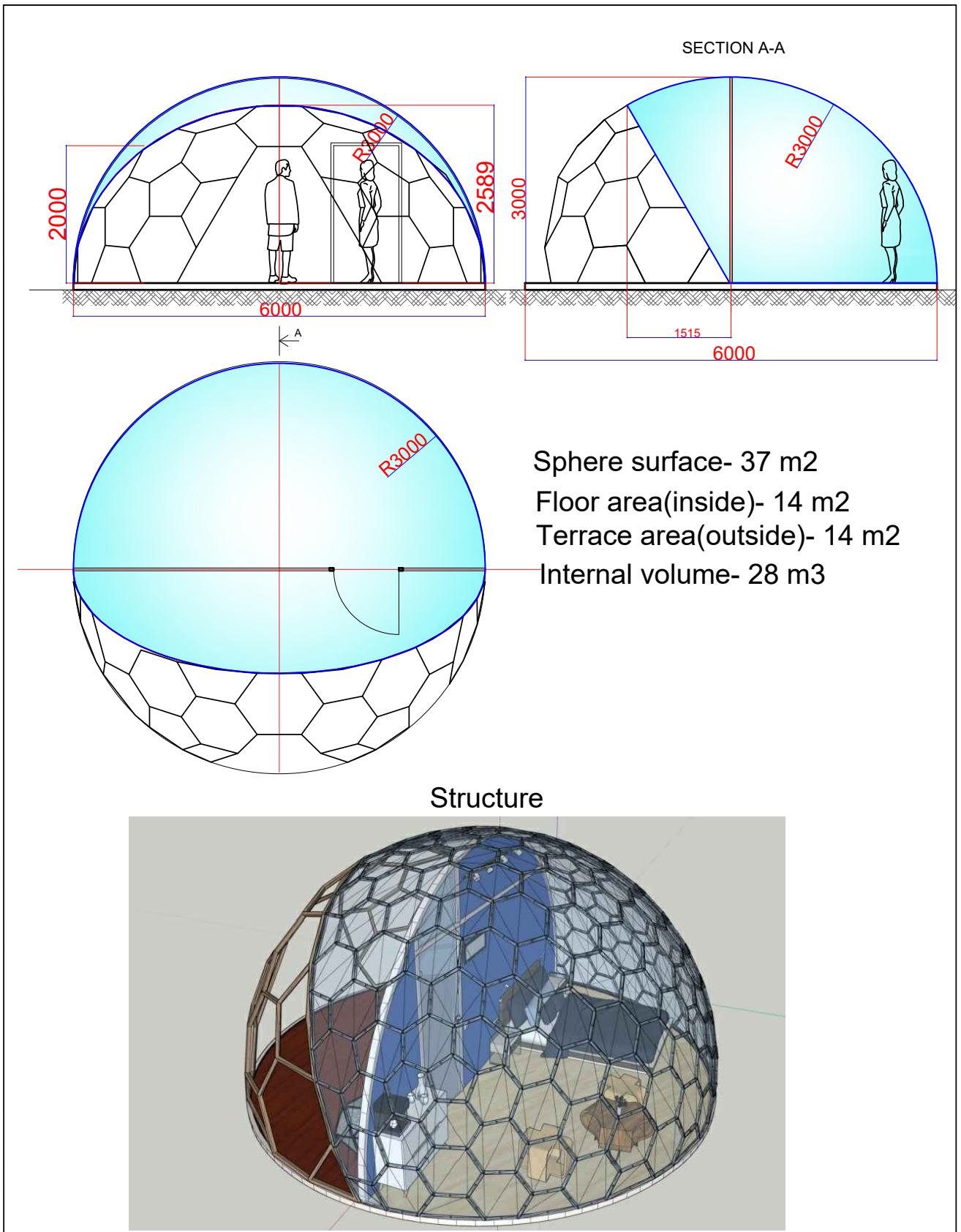

Aura Glamping 7m Diameter 3,5m Height

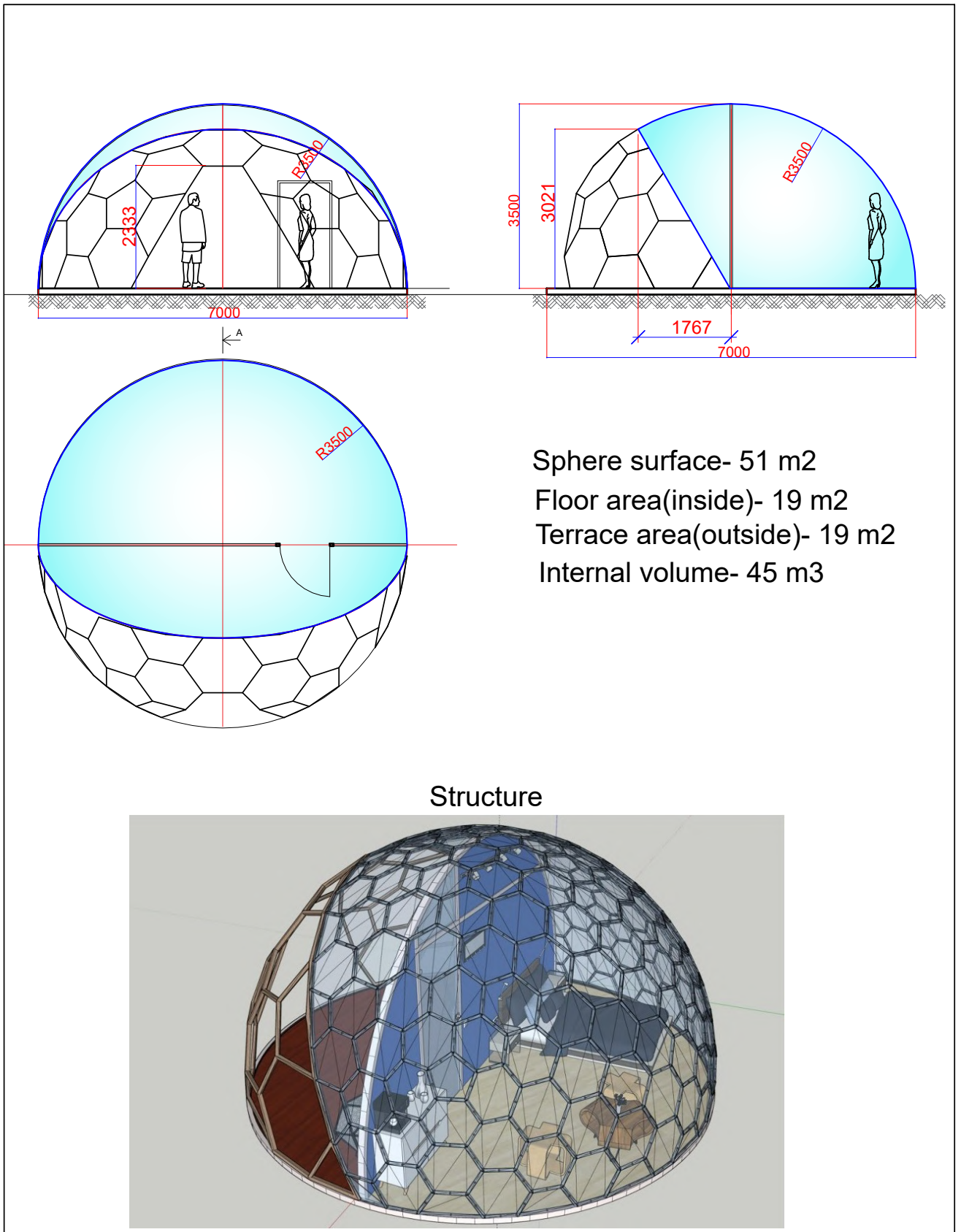

Aura Glamping 8m Diameter 4m Height

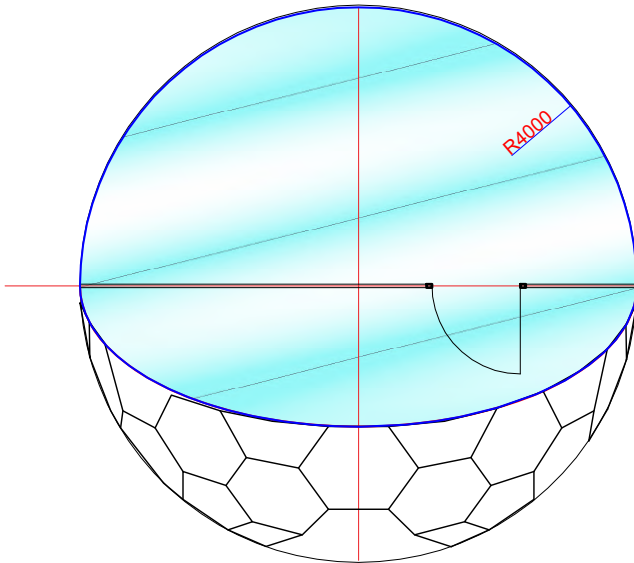
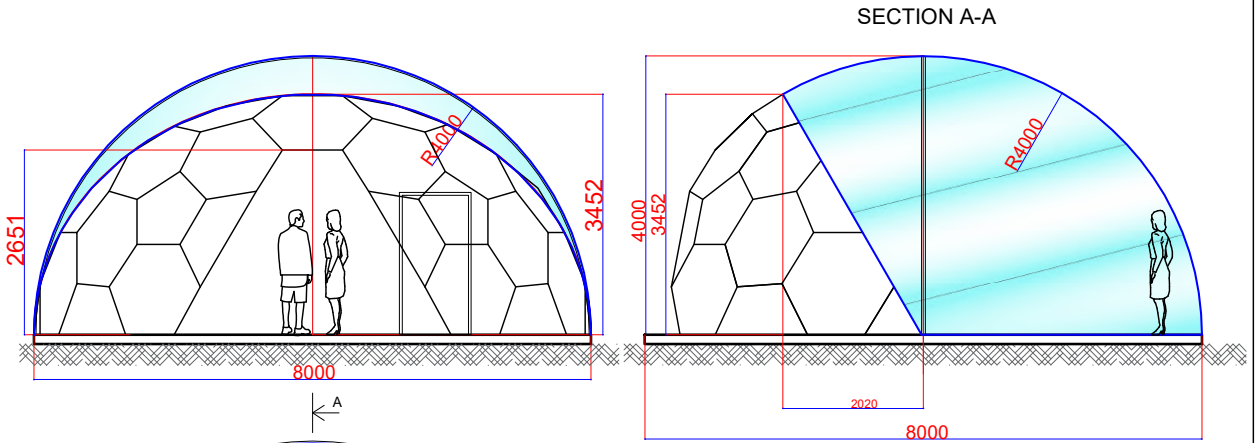

Sphere surface- 66.6 m²
Floor area(inside)- 25 m²
Terrace area(outside)- 25 m²
Internal volume- 66.5 m³

Structure

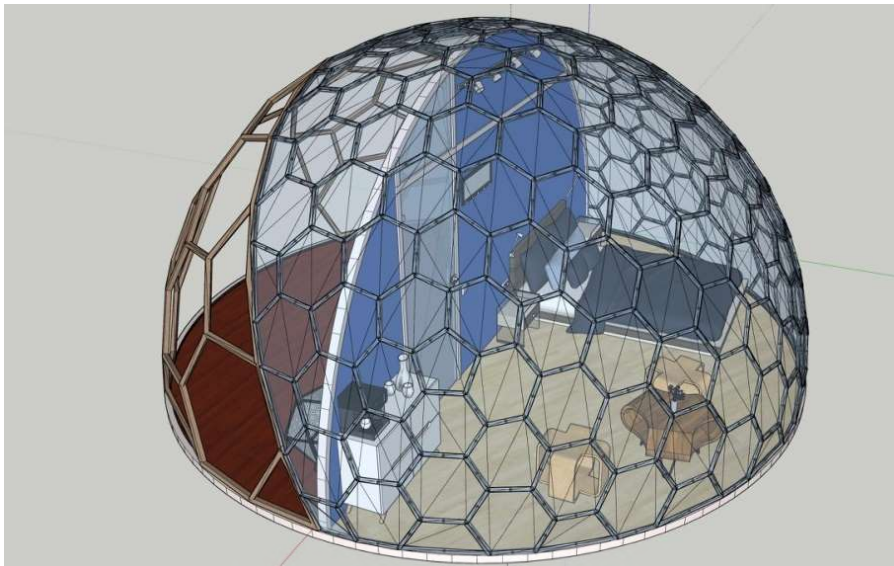

Aura Glamping 9m Diameter 4,5m Height

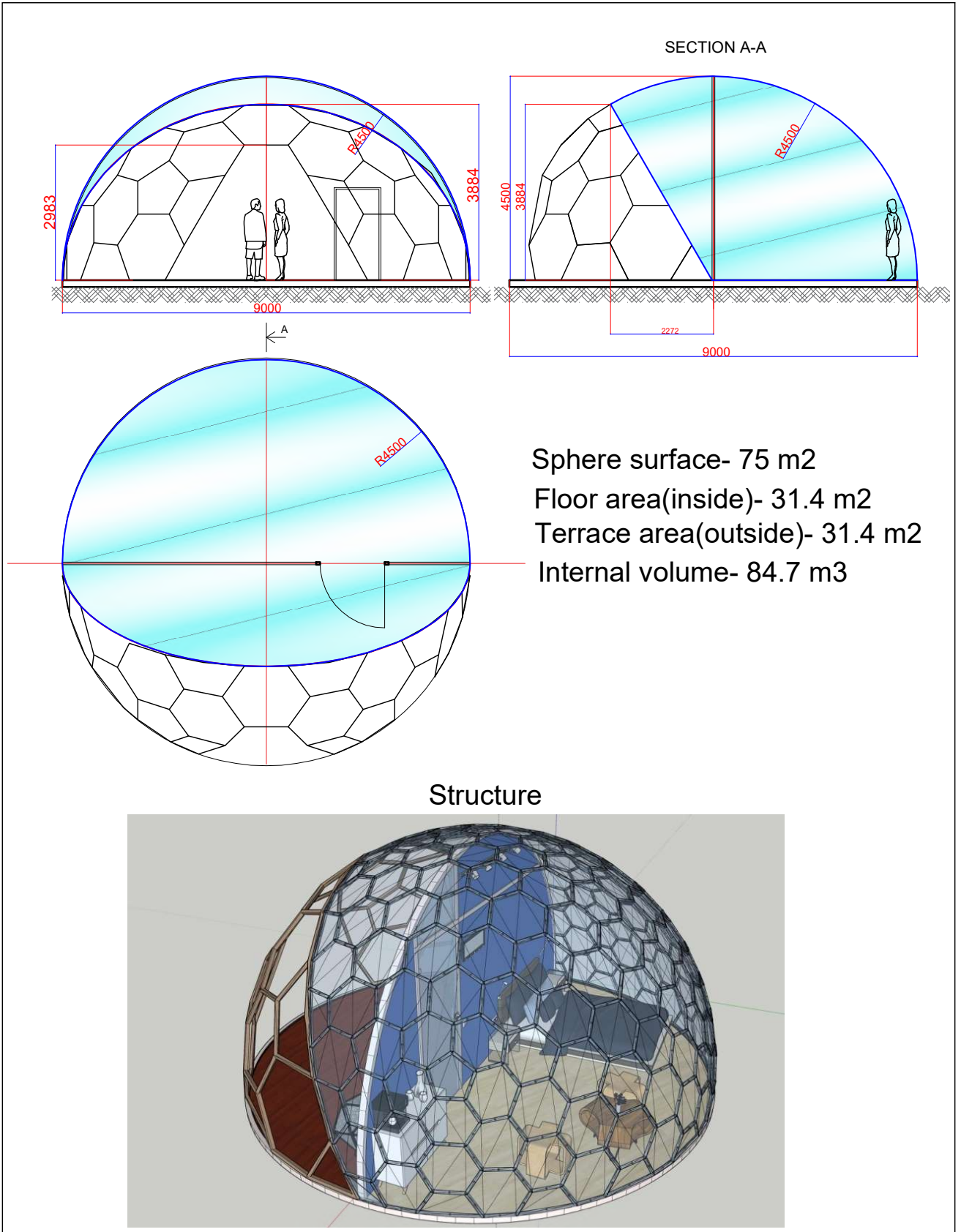

Aura Glamping 10m Diameter 5m Height

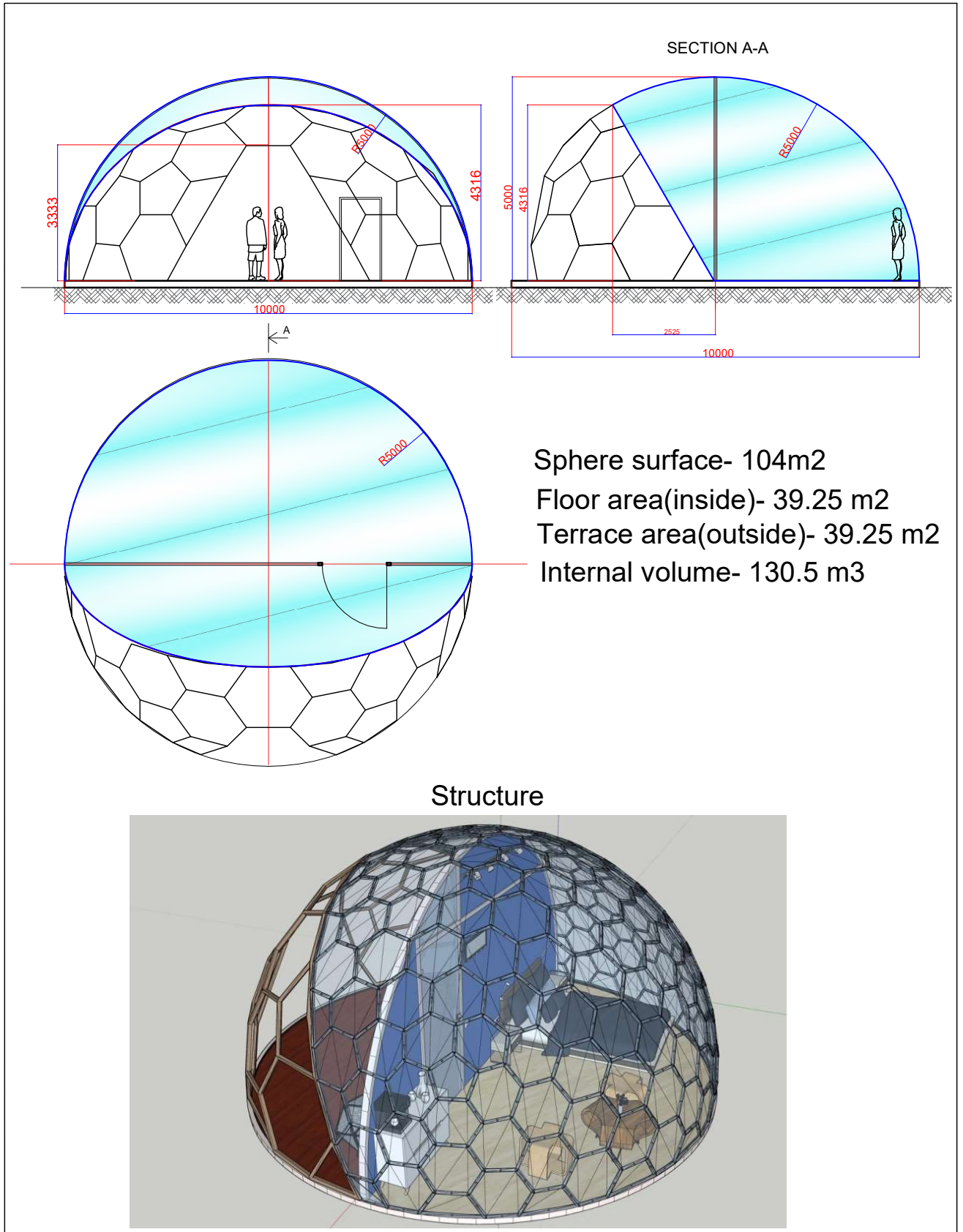

Aura Tunnel 24m Length 12m Width

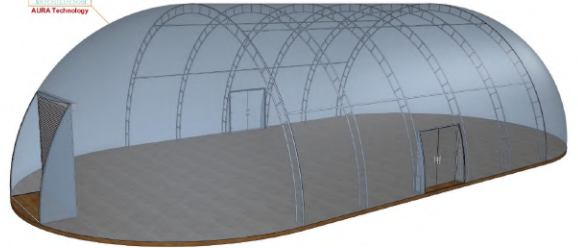
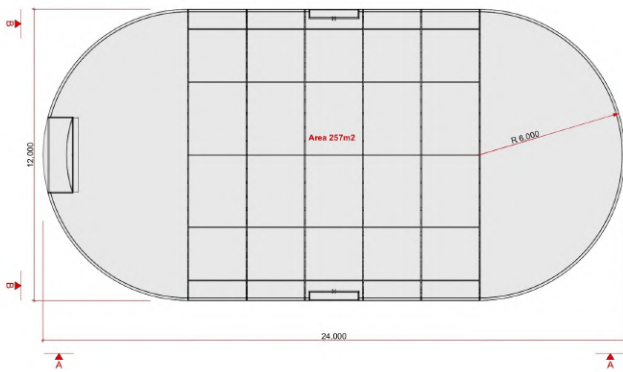
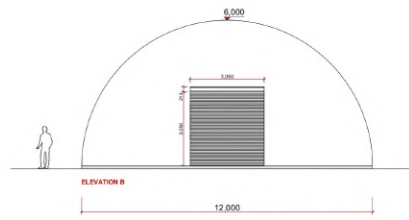
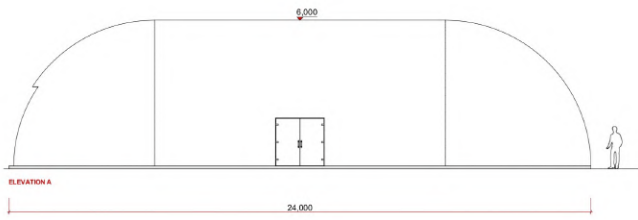

		ALPHA	
Nome: Indirizzo: Telefono: Email:		Nome: Indirizzo: Telefono: Email:	
Data: Firma:	Data: Firma:	Data: Firma:	Data: Firma:

Aura Tunnel 4,87m Length 2,44m Width

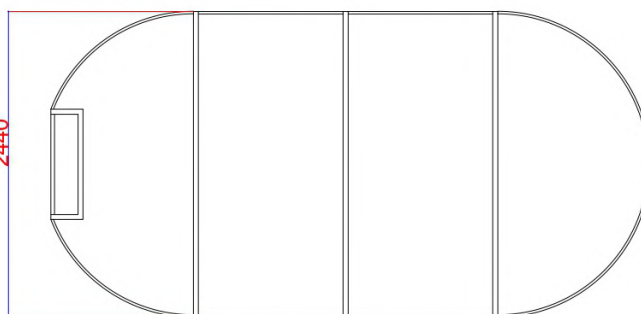
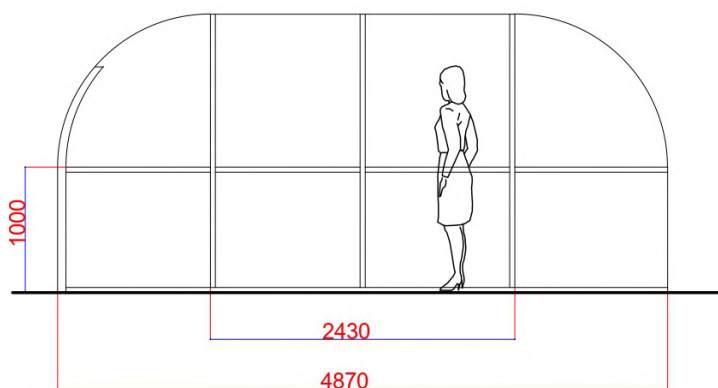
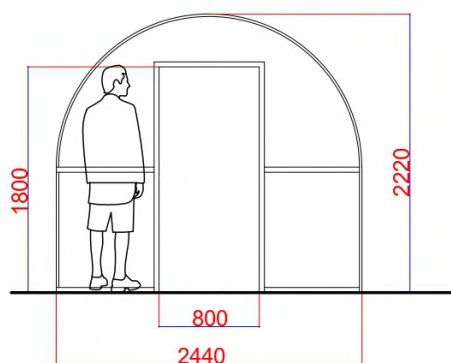

Sphere surface- 30,4 m2
 Floor area- 10,5 m2
 Internal volume- 20 m3
 PVC door -1pcs.

Certificate No. 8884	 VIKING DOME	Šeškinės sodų 2 Vilnius	Mobile: +37067003131 E-mail: info@vikingdome.com	D2,44H2,2L4,87T3	
TPV0075	Engineer	G.Brėskys	2022/08/24	Architektė	
Stadija	Customer: xxxxxxx xxxxxxx			Page	A4
DP				1	

Aura Tunnel 13m Length 5m Width

Aura D5H3

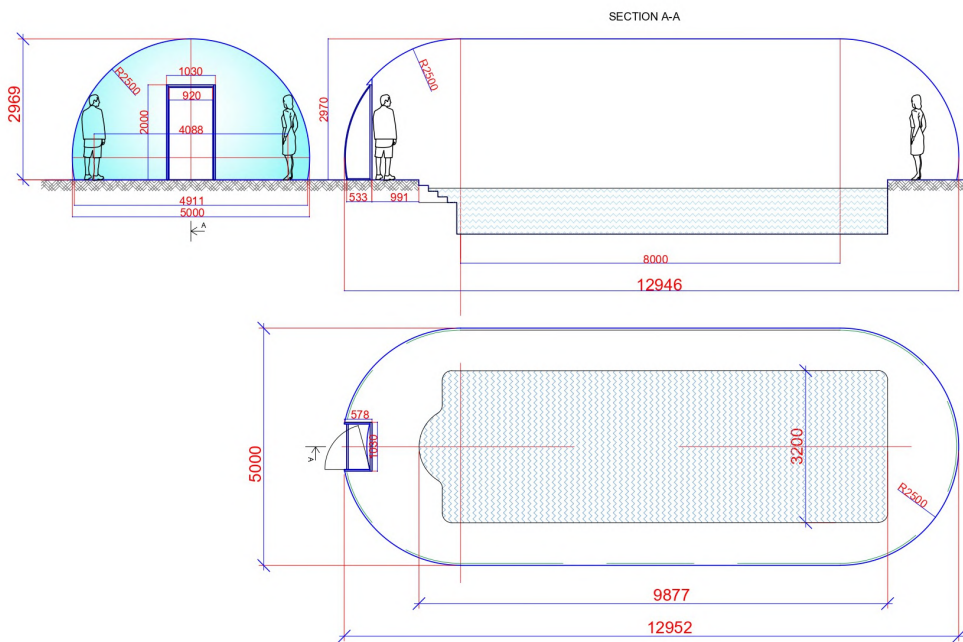

Cover surface- 117 m2
 Floor area- 59 m2
 Internal volume- 140 m3
 Weight- 750 kg

Certificate No 8884	V.I.K.I.N.G. DOHE	Šeštarnės sodų 2 Vilnius	Mobile - +37067002131 E-mail: info@vikingdohe.com	Aura D5H3F12T3-4L13	
TPV0075	Engineer G. Brėškys	2020/12/16	Architektūra	A4	Version 1
Customer:				Page	Pages
				1	1



**VIKING
DOME**

VikingDome – engineering and construction company behind development and manufacturing of the Aura Dome™ technology.



Worldwide delivery

Contact us:

www.vikingdome.com

sales@vikingdome.com