



NEXT LEVEL



2024



NEXT-LEVEL INNOVATION	2-3
REAL PARTNERSHIP	4-5
MERCHANDISING SOLUTIONS & PRO SHOPS	6-13
INTRODUCING NEW PRODUCTS	14-27
SMART-ASSIST™ ACCESSORIES	28-29
HIGH PERFORMANCE TOOLS FOR GUNS	30-49
HIGH PERFORMANCE GUN CLEANING™	50-65
GUN-SPECIFIC MULTI-TOOLS	66-71
REAL AVID BLADES	72-73
ABOUT US	74-75

NEXT-LEVEL INNOVATION.

Real Avid's unwavering commitment to innovation has propelled us to a prominent brand leadership position in the sphere of gun tools and cleaning. This year, our dedication to pushing boundaries goes beyond merely raising the bar; we are fundamentally redefining the category.

Real Avid's extensive product range spans from the meticulously crafted Master Grade® Tools to the highly effective High Performance Gun Cleaning™ products and industry-leading Gun Multi-Tools. Each offering within the Real Avid portfolio sets a new standard for real-world performance.

Professional marksmen, seasoned shooters, Gun DIY® enthusiasts and first-time gun buyers have come to rely on Real Avid's smart solutions. Our products go beyond conventional norms, providing innovative approaches that redefine the processes of cleaning, maintaining and gun building. The fusion of expertise and cutting-edge technology is evident in every Real Avid product, ensuring that users experience the pinnacle of functionality and performance.



PARTNERING FOR GROWTH.

WE WIN WHEN YOU WIN.

Your success is our success. Your shop, your customers, your employees and your relationships sell our products, and we are grateful for your expertise. Our team will work hard to understand your needs and devise a mutual plan to maximize your sales.



GUN DIY REDEFINED.

Our mission is understanding the GUN DIY customer and harmonizing the Real Avid brand and products with innovative solutions that revolutionize the category. We apply that same thinking to the development of best-in-class merchandising to communicate product benefits and drive turns for you.

MERCHANDISING REDEFINED.

Our Pro Shop Merchandising programs upgrade the shopping experience in your store and drive sales, traffic and margin. Contact our dedicated independent dealer support team to develop the best program for your needs and watch your sales grow!

MAKE IT HAPPEN!

Is there a section of your store that could use improvement? Ready to create a GUN DIY® product showcase that will command customer attention, energize your staff and elevate sales? Let us partner with you and prove the dramatic impact and results that will follow.

“Real Avid is the best in the business at designing impactful merchandisers for every space in our shop.”



CUSTOMIZED PRO SHOP MERCHANDISING EXCELLENCE.



You know your customers and the products they demand better than anyone. We aim to incorporate your knowledge and experience to build the ultimate merchandising solution tailored to your market. Choose as a starting point any of the Pro Shop Upgrade in-line assortments or endcaps, let us know your preferred product mix and we'll build you an amazing, attention-grabbing showcase. Results will include increased aisle traffic, higher turns on pegs and superior margins on gun cleaning products and tools. Let your ultimate customized Pro Shop showcase do the selling for you.

NEXT-LEVEL MERCHANDISING.

Real Avid® Pro Shop Upgrades provide visual appeal that commands your customers' attention and interest. Professionally-designed signage and thoughtful product organization eliminate frustration and intimidation from shopping for gun building, cleaning and maintenance tools, making it easy for your customers to find what they need for their GUN DIY® projects.



LEADERBOARD ASSORTMENT

Spanning 32 feet, the Leaderboard is a flagship destination. The attention-grabbing presentation showcases the entire Real Avid product line to establish you as THE destination for GUN DIY®. The Master Gun Workstation® and Master Gun Vise® display shelf provides an innovative hands-on experience to engage the customer and drive sales. Stand out as the market leader in product assortment, presentation and customer experience.

ITEM# AV432-24 MSRP \$22,644.19

Planogram includes:

- 179 SKUs, 781 units
- (2) 48" x 14.125" headers with hardware
- (2) 36" x 6" headers with hardware
- (1) 24" x 6" header with hardware
- (1) 12" x 8.6" header with hardware
- (5) 48" x 12" aisle violators with hardware
- (3) 6" x 12" high-fives with hardware
- Full set of reorder cards

Dealer needs to supply:

- Fixture
- 176 peg hooks
- Shelving for 15 SKUs

“Real Avid’s Pro Shops outsell every accessory brand in our store.”

The Real Avid Pro Shop Upgrade Assortments shown are designed on 1" pegboard. Depending on fixture type and material (grid, slatwall, etc.) that your shop currently owns, this layout may need to be modified during assembly. These planograms are a guideline of the proper product layout and signage location per assortment to maximize display space and consumer engagement. Fixtures and pegs are not included with the purchase of Real Avid Pro Shop Upgrade Assortments.

BULLSEYE ASSORTMENT

The Bullseye is an expanded collection of Real Avid best sellers and new products. At 12 feet wide, the assortment covers any caliber, any type of shooter and is a one-stop-shop featuring gun cleaning, maintenance and building essentials. Keep it fed and it will be the most profitable 12 feet in your gun cleaning and tool aisle.

ITEM# AV412-24 MSRP \$12,106.23

Planogram includes:

- 85 SKUs, 377 units
- (1) 48" x 14.125" header with hardware
- (2) 36" x 6" headers with hardware
- (3) 48" x 12" aisle violators with hardware
- (3) 6" x 12" high-fives with hardware
- Full set of reorder cards

Dealer needs to supply:

- Fixture
- 77 peg hooks
- Shelving for 14 SKUs



“Real Avid’s custom planograms are exactly what we needed in our shop.”

CORE ASSORTMENT

The Core is compact, but mighty. At 8 feet wide, this assortment includes Real Avid best sellers and key new products. The assortment is curated to fit a wide range of customer needs from chemicals, tools and kits. The Master Gun Vise® Floor Display highlights the first and only true gun vise on the market. Set yourself up to successfully drive turns and profits.

ITEM# AV48-24 MSRP \$10,018.10

Planogram includes:

- 62 SKUs, 290 units
- (1) 48" x 14.125" header with hardware
- (2) 48" x 12" aisle violators with hardware
- (2) 6" x 12" high-fives with hardware
- Full set of reorder cards
- Master Gun Vise floor display

Dealer needs to supply:

- Fixture
- 51 peg hooks
- Shelving for 12 SKUs



MASTER GUN VISE® FLOOR DISPLAY

Pro Shop Merchandising Also Available In:

- 16' Essential DIY Assortment
- 20' Top Shot Assortment
- Customizable sizes built to your space

See your local Real Avid Sales Rep. for more information!

MERCHANDISING SOLUTIONS THAT DRIVE SALES.



CLEANING ESSENTIALS DISPLAY FIXTURE

This 3' W x 5' H display includes our top selling cleaning products. From single-pass bore cleaning to complete kits and chemicals, this assortment serves most cleaning needs for gun owners. This display is a one-stop-shop for your customer's gun cleaning needs.

ITEM# AV43-24CED MSRP \$2,623.14

Planogram includes:

- 34 SKUs, 186 units
- (1) 36" x 60" x 18" pegboard fixture
- (2) 15.875" x 50.86" interchangeable graphic side panels
- (40) 8" black peg hooks
- Full set of reorder cards



BUILD & CUSTOMIZE DISPLAY FIXTURE

This 3' W x 5' H display includes a mix of our newest tools and top selling tools. From modifying AR15's to mounting scopes, or replacing handgun sights or grips, your customer can make their gun their own with this collection of products.

ITEM# AV43-23BCD MSRP \$3,289.55

Planogram includes:

- 13 SKUs, 45 units
- (1) 36" x 60" x 18" pegboard fixture
- (2) 15.875" x 50.86" interchangeable graphic side panels
- (40) 8" black peg hooks
- Full set of reorder cards



TOOL ESSENTIALS DISPLAY FIXTURE

This 3' W x 5' H display highlights our essential tools. From multi-tools to punch kits and our Master Gun Workstation®, this assortment provides the must-have items for gun maintenance and building.

ITEM# AV43-24TED MSRP \$2,949.45

Planogram includes:

- 15 SKUs, 55 units
- (1) 36" x 60" x 18" single-sided pegboard fixture
- (2) 15.875" x 50.86" interchangeable graphic side panels
- (40) 8" black peg hooks
- Full set of reorder cards



MASTER GUN WORKSTATION® FLOOR DISPLAY

Display includes:

- (1) Floor display with removable header
- (6) AVMGWS - Master Gun Workstation
- Dimensions: 34.5" x 56.5" x 17"

ITEM# AVMGW-FD6 MSRP \$1,199.94



MASTER GUN VISE® FLOOR DISPLAY

Display includes:

- (1) Floor display with removable header
- (6) AVARAMV - Master Gun Vise
- Dimensions: 24" x 55.25" x 9.75"

ITEM# AVMGV-FD6 MSRP \$1,799.94



REAL AVID BLADES RAV FSD

Display includes:

- (1) Convertible display with base – sidekick or floor display
- (7) RAV Blade SKUs, 32 units
- Sidekick Dimensions: 14" x 53.5" x 5.5"
- Floor Display Dimensions: 14" x 68" x 17"

ITEM# AVFSD-RAV MSRP \$1,239.68

SIDEKICK MERCHANDISERS



TRIPLE THREAT AEROSOL SIDEKICK
ITEM# AVCASK1
MSRP \$575.64



PGL AEROSOL SIDEKICK
ITEM# AVCASK2
MSRP \$575.64

SINGLE PANEL SIDEKICKS



BUILT-IN BACKER CARDS FOR EASY REORDER



BORE BOSS®
ITEM#
AVSPS-BB
MSRP \$559.44



BUILT-IN BACKER CARDS FOR EASY REORDER



GUN BOSS® MULTI-KIT
ITEM#
AVSPS-GBMK
MSRP \$1,109.64



BUILT-IN BACKER CARDS FOR EASY REORDER



MULTI-TOOL
ITEM#
AVSPS-GMT
MSRP \$1,229.70



BUILT-IN BACKER CARDS FOR EASY REORDER



REAL AVID BLADES - RAV
ITEM#
AVSPS-RAV
MSRP \$1,239.68

3 TOOL PDQs



3 TOOL PDQ - AR15 V2
ITEM# AV3T-AR2PDQ
MSRP \$509.82



3 TOOL PDQ - GIFTING
ITEM# AV3T-GPDQ
MSRP \$719.82



3 TOOL PDQ - CRITICAL CARRY
ITEM# AV3T-CCPDQ
MSRP \$719.82



REAL AVID BLADES - RAV PDQ
ITEM# AVRAV-PDQ
MSRP \$539.82

PRIME-9 PDQ



PRIME-9 HANDGUN CLEANING KIT
ITEM# AVGCK9MM-12D
MSRP \$179.88

4 OZ CHEMICAL PDQs



BORE-MAX® 4 OZ BOTTLE
ITEM# AVBMS4L-PDQ
MSRP \$119.88



GUN-MAX 4 OZ BOTTLE
ITEM# AVBMO4L-PDQ
MSRP \$119.88



TRI-MAX CLP 4 OZ BOTTLE
ITEM# AVCLP4L-PDQ
MSRP \$119.88



TRIPLE THREAT 4 OZ ASSORTMENT
ITEM# AVTT4L-PDQ
MSRP \$179.82

1 OZ CHEMICAL PDQs



GUN MAX 1 OZ BOTTLE
ITEM# AVGMO1L-PDQ
MSRP \$107.88

CLIP-STRIPS (PRODUCT NOT INCLUDED)



TRI-MAX CLP® CLIP STRIP
ITEM# AVDMS-CLPCS



GUN-MAX® GUN OIL CLIP STRIP
ITEM # AVDMS-GOCS



FIELD ESSENTIALS CLIP STRIP
ITEM# AVDMS-FECS

CUSTOMIZE TO WHAT YOUR CUSTOMERS WANT.

FREE ON REQUEST. CONTACT YOUR SALES REPRESENTATIVE.



NEW 2024



NEXT-LEVEL THINKING.

INTRODUCING NEW PRODUCTS

Our 2024 product lineup signifies a shift in GUN DIY®, delivering unparalleled innovation and efficiency. These thoughtfully engineered products redefine standards and offer superior performance. Upgrade your firearm maintenance experience with the Bore-Max® Master Cleaning Kit and Mobile Workstation. Explore the future of firearm care and trust in our legacy of innovation.

NEW

GO ANYWHERE. CLEAN ANYWHERE.



HIGH-PERFORMANCE, ALL-IN-ONE, GUN CLEANING KIT IN A MOBILE WORKSTATION.

- RIFLE**
- .22 / .223 CAL / 5.56MM
- .243 CAL / 6MM
- .260 CAL / 6.5MM
- .270 CAL, .284 CAL / 7MM
- .30 CAL / 7.62MM
- HANDGUN**
- .22 CAL, .380 CAL / 9MM
- .40 CAL, .45 CAL
- SHOTGUN**
- 20 GA, 12 GA

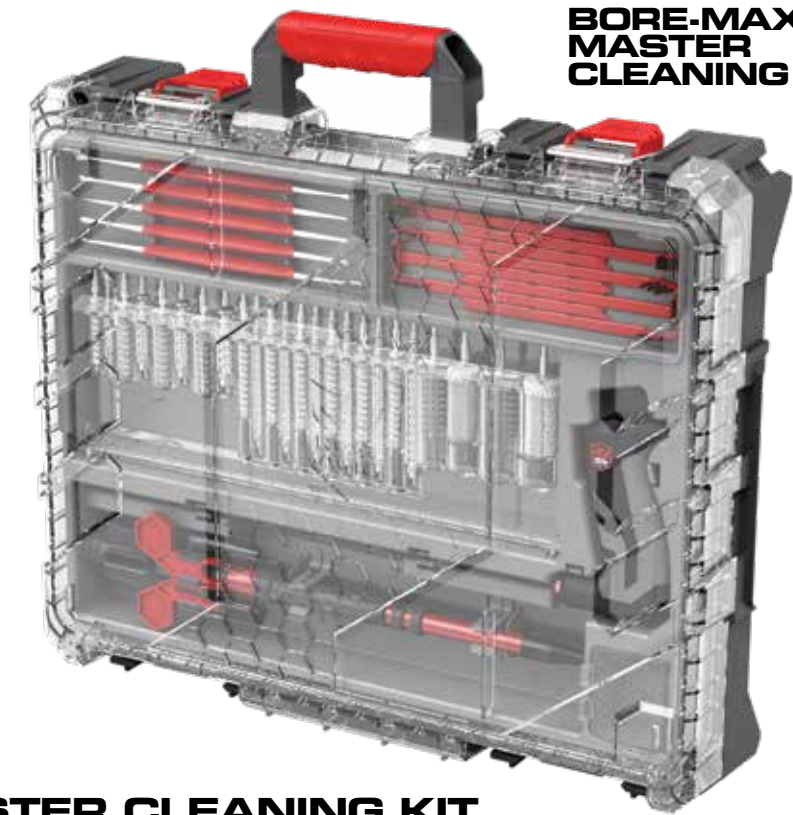

BORE-MAX® MASTER CLEANING KIT AND MOBILE WORKSTATION

The Bore-Max Master Cleaning Kit and Mobile Workstation combines the most comprehensive set of high performance cleaning tools with an integrated stand that allows you to clean your guns better and faster anywhere. First-of-its-kind spring-loaded Smart-Fit® Bore-Guide™ offers a deep and consistent seal of the chamber. The Bore-Max Speed Clean System™ cleans bores up to 4x faster and pairs with our new Bore-Max 3-Piece Speed Rod with ultra-glide bearing. Also includes Accu-Grip™ Steel Picks, Smart Brush® Cleaning Brushes and a cleaning mat. This kit provides the most effective way to clean any firearm. All housed in the innovative Mobile Workstation. The workstation is designed to let you clean your gun anywhere. The built-in yokes firmly grip barrels, handguards and stocks. And the four Smart-Assist docks allow you to add a work light (included), magnifying glass or cell phone holder.

NEW ITEM # AVBMMK | MSRP \$199.99



MOBILE WORKSTATION WITH GUN GRIPPER YOKES

- BORE-MAX® BRUSHES™
- BORE-MAX SPEED JAGS™
- BORE-MAX SPEED JAG PATCHES™
- BORE-MAX 3-PIECE SMART ROD – 42"
- SMART-FIT BORE GUIDE
- ACCU-GRIP STEEL PICKS
- SMART BRUSH CLEANING BRUSHES
- GUN & PARTS CLEANING MAT
- SMART-ASSIST™ WORK LIGHT
- INTEGRATED SMART DOCKS

- COMPATIBLE WITH**
- SMART ASSIST**
ACCESSORIES
- 180 LUMEN WORK LIGHT
 - 5-INCH MAGNIFYING GLASS
 - CELL PHONE HOLDER
- (5-INCH MAGNIFYING GLASS AND CELL PHONE HOLDER NOT INCLUDED - SOLD SEPARATELY)



THE FIRST PLUG & PLAY HANDS-FREE ACCESSORY SYSTEM FOR GUN DIY[®] KEEPS GETTING BETTER.

SMART-ASSIST QUICKLY CONNECTS WHENEVER AND WHEREVER YOU NEED THEM.

180 LUMEN WORK LIGHT
3 SELECTABLE SETTINGS TO ILLUMINATE DARK, HARD-TO-SEE AREAS.

5-INCH MAGNIFYING GLASS
GREAT FOR MAGNIFYING DELICATE TASKS.

CELL PHONE HOLDER
A HANDS-FREE WAY TO WATCH OR CREATE HOW-TO VIDEOS.

QUICK-CONNECT SMART-DOCK SYSTEM

ATTACHES TO YOUR WORKBENCH

UPGRADE YOUR WORKBENCH EXPERIENCE.

SMART-ASSIST™ QUICK-CONNECT SYSTEM – ESSENTIAL 3-PACK WITH SMART-DOCK™

The smart and easy way to mount accessories to your work area. Simply attach the Smart-Assist Accessory System to your Master Gun Vise[®], Master Gun Workstation[®], Master Cleaning Kit and Mobile Workstation or benchtop for a better working experience. The quick-connect locking system offers a one-handed, flexible way to magnify or illuminate your Gun DIY projects while watching your favorite gunsmith.

NEW ITEM # AVMVACC | MSRP \$99.99

NEW

DOCKING SYSTEMS QUICKLY CONNECT SMART-ASSIST ACCESSORIES WHENEVER AND WHEREVER YOU NEED THEM.

COMPATIBLE WITH
SMART ASSIST
ACCESSORIES

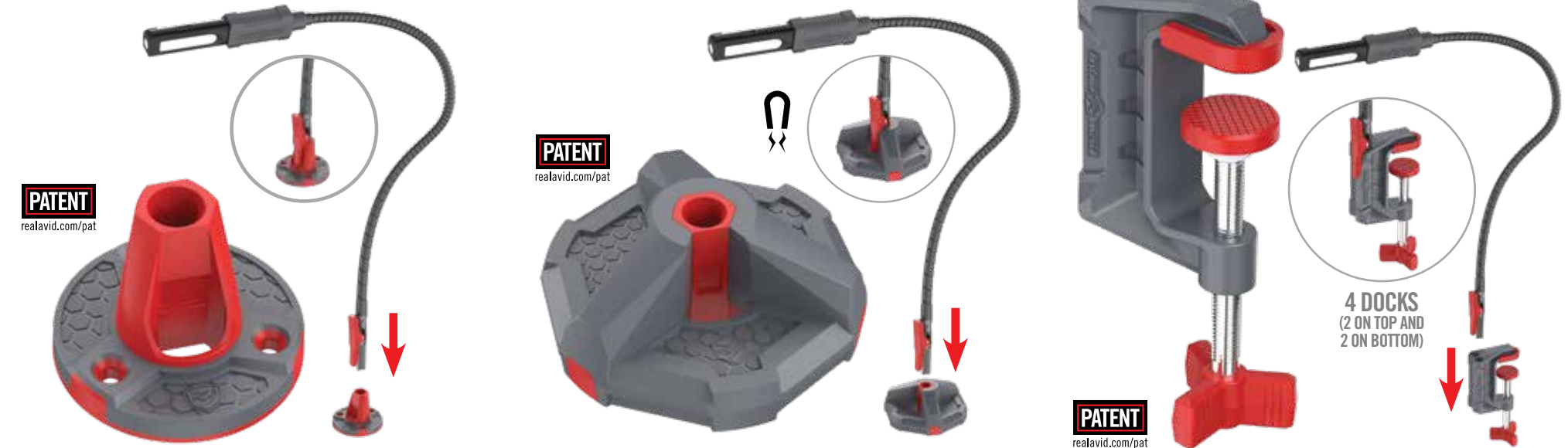

SMART-ASSIST SURFACE MOUNT
3-PACK SURFACE AND FLUSH MOUNT.

SMART-ASSIST MAGNETIC MOUNT
HANDS-FREE MAGNETIC MOUNTABLE SMART-ASSIST DOCK.

SMART-ASSIST C-MOUNT
UP-TO 2-1/4" MOUNTING CAPACITY FOR A SECURE FIT.

SMART-ASSIST™ DOCKING MOUNTS

Smart-Assist Docking Mounts redefine hands-free efficiency. The Surface Mount 3-Pack optimizes space with a reversible design, attaching to multiple surfaces for instant assistance. The Magnetic Mount, with six strong magnets, offers hands-free enhancement on steel surfaces. The C-Mount guarantees a stable fit on flat edges, with reversible mounting and four Smart-Docks™ for customized assistance. Upgrade your workspace with Smart-Assist for seamless, intelligent work assistance and enhanced productivity.

NEW SMART-ASSIST – SURFACE MOUNT 3-PACK
NEW SMART-ASSIST – MAGNETIC MOUNT
NEW SMART-ASSIST – C-MOUNT

ITEM # AVSASDM MSRP \$19.99
ITEM # AVSAMM MSRP \$29.99
ITEM # AVSACM MSRP \$24.99

NEW

EXPAND YOUR MASTER GUN VISE® WITH PROJECT-SPECIFIC JAWS.

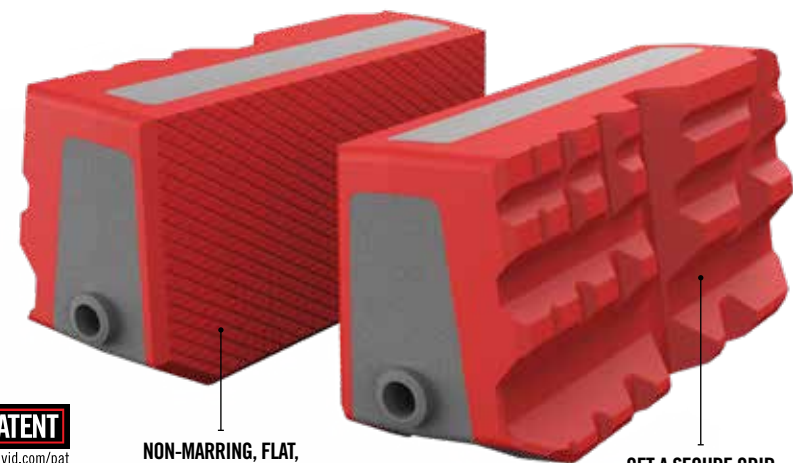

PATENT
realavid.com/pat

NON-MARRING, FLAT, TEXTURED SURFACE

GET A SECURE GRIP ON BCG'S, BARRELS AND CHOKE TUBES

RUBBER-COVERED MULTI-FIT SLEEVES ACCOMMODATE ALL SIZES AND SHAPES OF GUNS AND PARTS TO HOLD THEM SECURELY.

SMART-JAWS™ - MULTI-FIT™ SLEEVES FOR MASTER GUN VISE

When it comes to working on firearms, there is no one-surface area or jaw angle that fits every need. From long guns and pistols, to barrels and guide rods, The Smart-Jaws — Multi-Fit Sleeves have you covered. These non-marring, thermoplastic rubber-covered jaws accommodate all sizes and shapes of guns and parts to hold them securely without damaging your investment. The flat, but slightly textured area is designed to secure your shotgun, pistol or bolt gun. When working on bolts, barrels or choke tubes, simply reverse the jaws and find the groove that best fits your project needs.

NEW ITEM # AVSFJMF | MSRP \$34.99

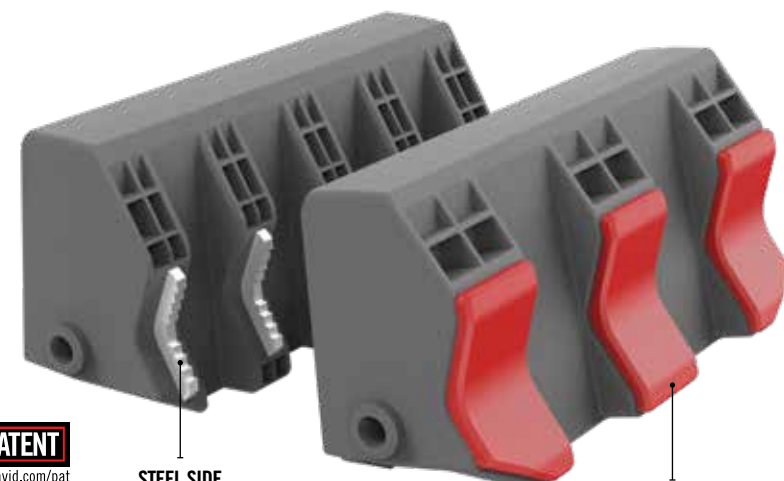

PATENT
realavid.com/pat

STEEL SIDE APPLIES THE ULTIMATE GRIP

SOFT, INTERLOCKING JAWS SECURES GRIPPING AND TORQUING POWER

TUBE-FIT SLEEVES ARE ENGINEERED TO PROVIDE A SECURE GRIP ON SUPPRESSORS, PIPE & TUBE.

SMART-JAWS™ - TUBE-FIT™ SLEEVES FOR MASTER GUN VISE

Securing cylindrical objects can be difficult and frustrating without the right tool for the job. Smart-Jaws — Tube-Fit Sleeves are engineered to provide a secure grip on suppressors, PVC and cast-iron pipe, and all types of tubing, and are two-sided to best fit the application. For delicate items such as suppressors, the non-marring, soft jaws provide ample gripping power to loosen the tightest fits without damaging your investment. For tough jobs when marring is not an issue, such as with cast-iron pipe or steel tubing, simply reverse the jaws to the steel side for the ultimate grip.

NEW ITEM # AVSFJPF | MSRP \$44.99

NEW

PIN PUNCHING MADE EASY.

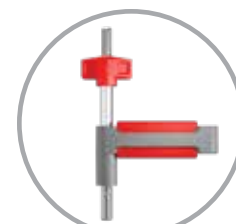

SMART-BLOCK CLAMPS

DESIGNED FROM THE GROUND UP TO WORK BETTER ON GUNS.

SMART-BLOCK CLAMPS FIRMLY HOLD PARTS IN PLACE, ENSURING STABILITY DURING PIN PUNCHING.

14 HOLES AND 2 GROOVES POSITIONED OPTIMALLY FOR FLEXIBILITY

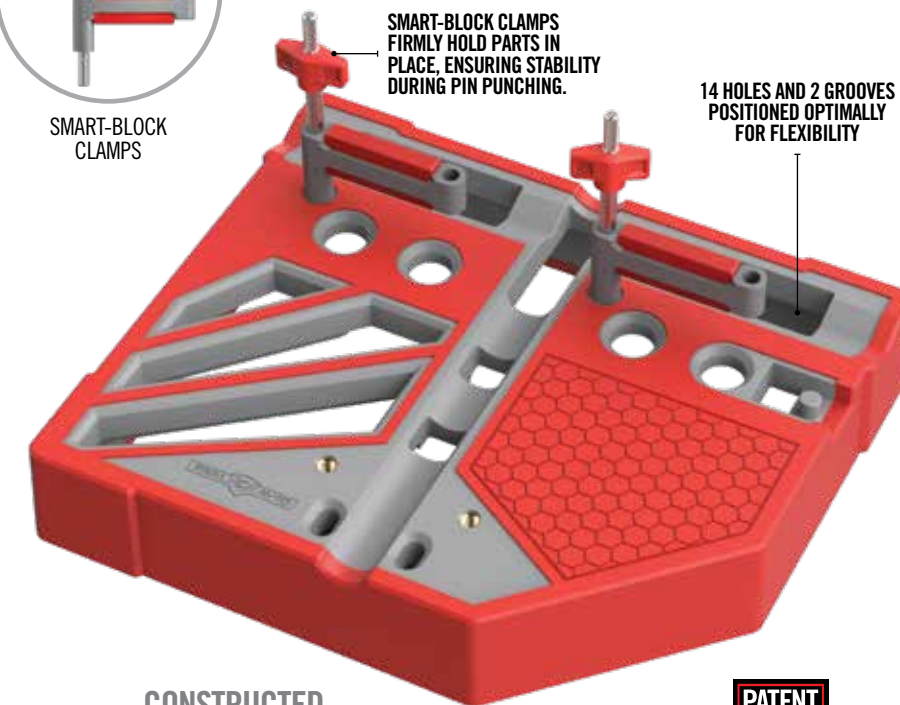

CONSTRUCTED FROM HIGH-QUALITY ENGINEERING-GRADE RESIN

PATENT
realavid.com/pat

MASTER BENCH BLOCK® PRO

With 14 strategically placed holes, 2 grooves and a larger design, precise pin alignment is made easy for all firearms. This block was constructed with upmost attention to detail for those looking to clean, repair or modify their firearms. The three elongated slots quickly align with compact size to full size pistols. Both the vertical and horizontal grooves offer the properly needed length and cutouts for work to be performed on long and short action bolts. To help secure parts, frames or barrels firmly in place, two Smart-Block Clamps have been incorporated into the block, allowing the end user to focus purely on the task at hand. Mounted inside are two strong magnets that grasp any pin you punch out and hold it securely to the block.

NEW ITEM # AVMBBPRO | MSRP \$39.99

NEW

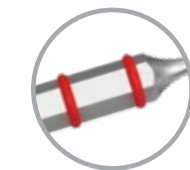

HEX-SHAPED HANDLES AND RUBBER O-RINGS FOR PRECISE CONTROL.



14 HOLES AND 2 GROOVES POSITIONED OPTIMALLY FOR FLEXIBILITY

SMART-BLOCK CLAMPS FIRMLY HOLD PARTS IN PLACE, ENSURING STABILITY DURING PIN PUNCHING.



PATENT
realavid.com/pat

ALL-IN-ONE BENCH BLOCK, HAMMER AND PUNCH SET

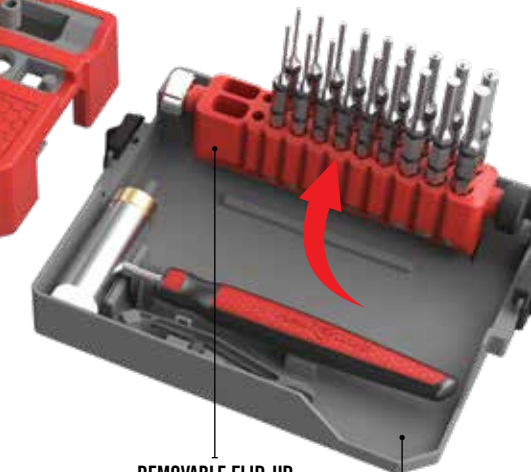

REMOVABLE FLIP-UP PIN PUNCH STORAGE

MAGNETIC PIN-CATCHING TRAY

MASTER BENCH BLOCK PRO-KIT

The Master Bench Block Pro-Kit is a comprehensive pin punching solution that simplifies your work. This all-in-one set includes 18 hardened steel punches and an ergonomic hammer with interchangeable heads stored within a spacious bench block. With 14 strategically placed holes, 2 grooves and a larger design, precise pin alignment is made easy for all firearms. The three elongated slots quickly align with compact size to full size pistols. To help secure parts, frames or barrels firmly in place, two Smart-Block Clamps have been incorporated into the block, allowing the end user to focus purely on the task at hand. When the work is done, store all your tools into the integrated storage tray for an easy storage solution.

NEW ITEM # AVMBBPKIT | MSRP \$79.99

NEW

PROFESSIONAL ARMORER'S HAMMER.



PIN STARTER FITS
1/16" TO 7/32"
1.8MM TO 7.14MM

INTEGRATED
MAGNETIC PIN
STARTER

PATENT
realavid.com/pat

ARMORER'S MASTER HAMMER™

Tested and influenced by gunsmiths, the Armorer's Master Hammer is a 22-ounce, 9-1/2" long, forged hammer with full-length tang for a perfect balance and ideal ergonomics for precise control. A removable soft blow hammer head cover and interchangeable hammer heads with integrated storage makes it easy to install the correct hammer head for the application. Stored in the handle is a removable, stainless steel, magnetic pin starter to provide a helping hand when building or modifying firearms.

NEW ITEM # AVARMHAM | MSRP \$69.99

NEW

ARMORER'S MASTER HAMMER AND 11-PIECE STANDARD PIN PUNCH SET.



PATENT
realavid.com/pat

2x 1/16", 5/64", 3/32"
1/8", 9/64", 5/32", 3/16",
7/32", 1/4", 9/32"
steel punches

ARMORER'S MASTER HAMMER™ AND ACCU-PUNCH® 11-PIECE STANDARD PIN PUNCH SET

The Armorer's Master Hammer and Accu-Punch 11-Piece Standard Pin Punch Set, meticulously designed for gunsmiths. The Armorer's Master Hammer boasts a 22-ounce forged hammer with a full-length tang for precision control. It comes with interchangeable hammer heads and a magnetic pin starter for effortless adaptation and firearm modifications. The Accu-Punch set features hardened steel punches with nickel plating for corrosion resistance and a hex-shaped handle for precise control. Elevate your gunsmithing with these essential tools, designed for unmatched precision and durability.

NEW ITEM # AVAMHAPS | MSRP \$89.99

NEW

THE MOST FREQUENTLY USED GUNSMITHING PIN PUNCHES.



PATENT
realavid.com/pat

2x 1/16", 5/64", 3/32"
1/8", 9/64", 5/32", 3/16",
7/32", 1/4", 9/32"
steel punches

ACCU-PUNCH® 11-PIECE STANDARD PIN PUNCH SET

Gunsmithing punches are core tools needed to modify or disassemble firearms. The Accu-Punch 11-Piece Standard Pin Punch Set is designed from the ground up to work better with firearms. The punches are made of hardened steel with a nickel plating to resist corrosion. The hex-shaped handle and rubber O-rings provide precise control during use.

NEW ITEM # AVAPK-S | MSRP \$29.99



PATENT
realavid.com/pat

2x 1/16", 5/64", 3/32"
1/8", 9/64", 5/32", 3/16",
7/32", 1/4", 9/32"
roll pin punches

ACCU-PUNCH® 11-PIECE ROLL PIN PUNCH SET

Gunsmithing punches are core tools needed to modify or disassemble firearms. The Accu-Punch 11-Piece Roll Pin Punch Set is designed from the ground up to work better with firearms. The punches are made of hardened steel with a nickel plating to resist corrosion. The hex-shaped handle and rubber O-rings provide precise control during use.

NEW ITEM # AVAPK-RP | MSRP \$29.99

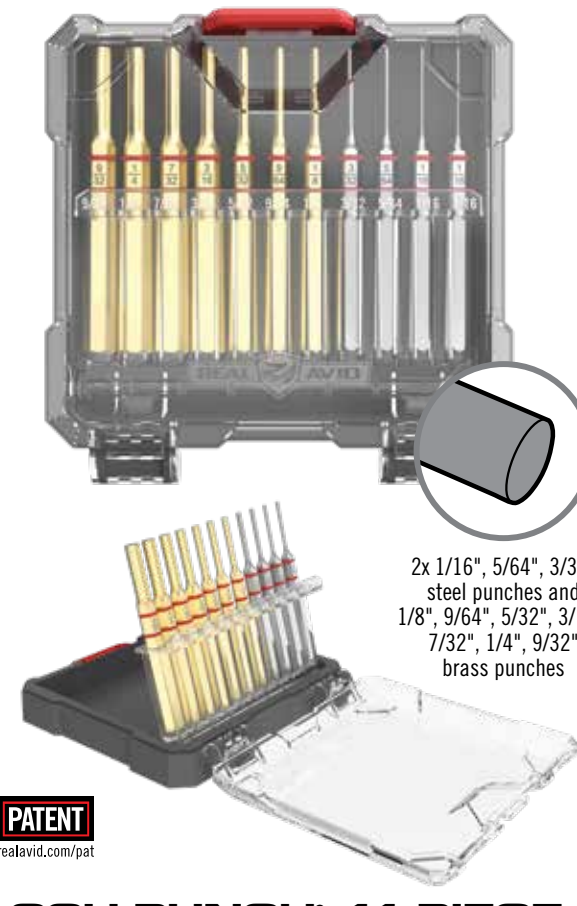

PATENT
realavid.com/pat

2x 1/16", 5/64", 3/32"
steel punches and
1/8", 9/64", 5/32", 3/16",
7/32", 1/4", 9/32"
brass punches

ACCU-PUNCH® 11-PIECE STANDARD BRASS & STEEL PIN PUNCH SET

Gunsmithing punches are core tools needed to modify or disassemble firearms. The Accu-Punch 11-Piece Standard Brass & Steel Pin Punch Set is designed from the ground up to work better with firearms. The punches are made of brass and hardened steel with a nickel plating to resist corrosion. The hex-shaped handle and rubber O-rings provide precise control during use.

NEW ITEM # AVAPK-B | MSRP \$39.99

NEW

EXTREME CORROSION PROTECTION & LUBRICATION

PROTECTS GUNS LONGER



GUN-MAX® GUN OIL — 1 OZ BOTTLE

Gun-Max's advanced gun-metal grade formula sets a new standard for protecting, lubricating and cleaning modern guns. Maximizes performance of semi-auto guns with high cycle rates. Formulated to excel in sub-zero temperatures and harsh operating conditions.

NEW ITEM # AVGMG01L | MSRP \$8.99

NEW

SPRING-LOADED DESIGN ALLOWS FOR CONSISTENT CHAMBER SEALING.

BORE-FIT™ PRECISION

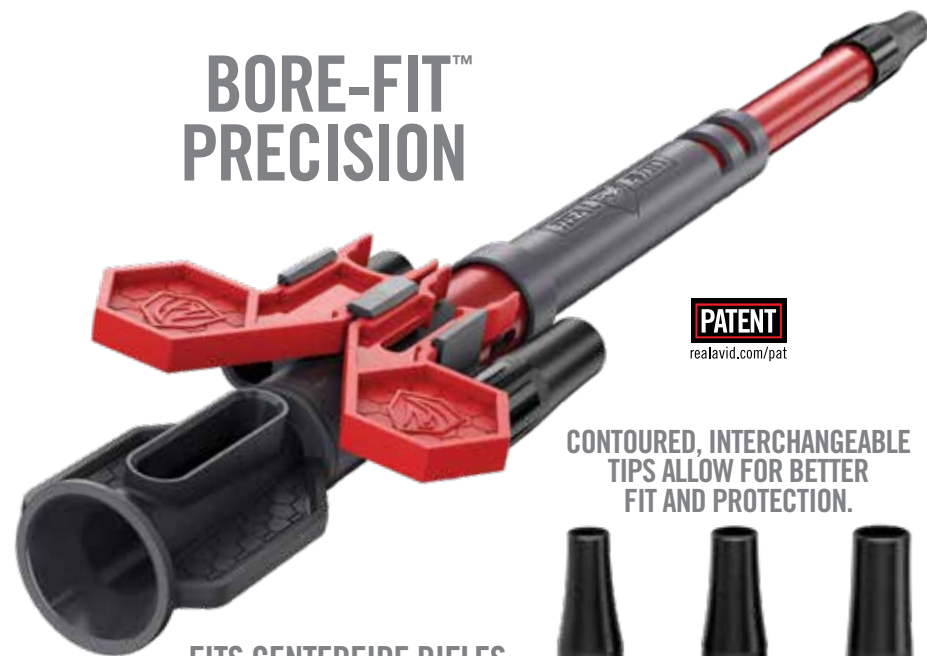

CONTOURED, INTERCHANGEABLE TIPS ALLOW FOR BETTER FIT AND PROTECTION.

FITS CENTERFIRE RIFLES
.223 - .375 CAL



SMART-FIT® BORE GUIDE™

The Smart-Fit Bore Guide is the ultimate and first-of-its-kind spring-loaded, precision cleaning tool providing worry-free cleaning. The spring-loaded slider locks, providing a secure fitment and ensures a consistent chamber sealing with zero movement when running brushes and patches through your bore. An anodized aluminum tube is designed for lasting durability and the contoured, non-marring, bore-specific tips ensure damage-free, precise fitment on centerfire rifles from .223 - .375 caliber.

NEW ITEM # AVBMBG | MSRP \$24.99

NEW

AR15 TACTICAL CARRY TOOL.

TACTICAL KNIFE AND MULTI-TOOL FOR AR15



REMOVE CARBON FROM ALL SURFACES OF BOLT CARRIER GROUP.

GUN TOOL EDGE™ - AR15

The pinnacle of tactical knife/multi-tool designed exclusively for the AR15 platform. Boasting a razor-sharp 2.6" Tanto blade and premium titanium and black oxide finishes, this tool ensures durability and longevity. With 12 bolt carrier group scrapers, firing pin scraper, carrier scraper, firing pin retaining pin puller, tap hammer, takedown punch, and bolt override, this compact and rugged design maximizes functionality in the field and at the range. Engineered for unmatched precision and reliability, Gun Tool Edge - AR15 is the essential companion for those who demand excellence from their equipment. Upgrade your arsenal and redefine your standards of performance.

NEW ITEM # AVGTE-AR | MSRP \$49.99

NEW

PISTOL PACKING CAPABILITY.

TACTICAL KNIFE AND MULTI-TOOL FOR PISTOLS



GUN TOOL EDGE - PISTOL

The tactical knife/multi-tool designed exclusively for pistols. This innovative companion ensures your firearm remains operational in any situation with a 2.6" Wharncliffe knife blade, laser sight/trigger adjustment hex keys, 2.5mm pin punch, flat carbon scraper and more. Designed with premium titanium and black oxide finishes, this tool combines durability with style. The stainless steel components, including a pick, metal file and nut wrench, guarantee easy access and secure locking. Experience efficiency and precision in firearm maintenance with Gun Tool Edge - Pistol – a purpose-driven solution for discerning pistol owners.

NEW ITEM # AVGTE-P | MSRP \$49.99

BORN READY.™

RAV™-1

Handle Material
Nylon
Blade Length
3.25 inch.
Blade Profile
Modified Clip Point
Blade Material
4Cr14
Blade Finish
Black Oxide
Lock Type
Liner Lock



RAV™-2

Handle Material
Aluminum
Blade Length
3.25 inch.
Blade Profile
Drop Point
Blade Material
8Cr13MoV
Blade Finish
Black Oxide
Lock Type
Liner Lock
Spring Assist



RAV™-3

Handle Material
Aluminum + SS
Blade Length
3.25 inch.
Blade Profile
Drop Point
Blade Material
8Cr13MoV
Blade Finish
Black Oxide
Lock Type
Liner Lock
Spring Assist



RAV™-4

Handle Material
Glass-Filled Nylon
Blade Length
3.25 inch.
Blade Profile
Drop Point
Blade Material
8Cr13MoV
Blade Finish
Black Oxide
Lock Type
Axis Lock
Spring Assist



RAV™-5

Handle Material
Aluminum + CF
Blade Length
3.4 inch.
Blade Profile
Drop Point
Blade Material
8Cr13MoV
Blade Finish
Titanium
Lock Type
Liner Lock
Spring Assist



RAV™-6

Handle Material
Aluminum + CF
Blade Length
3.4 inch.
Blade Profile
Tanto
Blade Material
8Cr13MoV
Blade Finish
Titanium
Lock Type
Liner Lock
Spring Assist



RAV™-7

Handle Material
G10
Blade Length
3.25 inch.
Blade Profile
Drop Point
Blade Material
8Cr13MoV
Blade Finish
Titanium
Lock Type
Liner Lock
Spring Assist



REAL AVID BLADES - RAV SERIES

Being READY is more than a state of mind, it's a way of life and a commitment to yourself and the ones you love. Real Avid Blades are BORN READY for the toughest challenges encountered by your carry knife. Born from the Real Avid culture of proven real-world performance, passion and a relentless pursuit of innovation, these blades are purpose-built. They're BORN READY.

NEW RAV-1
NEW RAV-2
NEW RAV-3
NEW RAV-4
NEW RAV-5
NEW RAV-6
NEW RAV-7

ITEM # AVRAV1
ITEM # AVRAV2
ITEM # AVRAV3
ITEM # AVRAV4
ITEM # AVRAV5
ITEM # AVRAV6
ITEM # AVRAV7

MSRP \$24.99
MSRP \$29.99
MSRP \$34.99
MSRP \$39.99
MSRP \$44.99
MSRP \$44.99
MSRP \$49.99





THE SMART AND EASY WAY TO MOUNT ACCESSORIES TO YOUR WORK AREA.

THE FIRST PLUG & PLAY HANDS-FREE ACCESSORY SYSTEM FOR GUN DIY®.

SMART-ASSIST™ QUICK-CONNECT SYSTEM — ESSENTIAL 3-PACK WITH SMART-DOCK™

Simply attach the Smart-Assist Accessory System to your Master Gun Vise, Master Gun Workstation, Master Cleaning Kit and Mobile Workstation or benchtop for a better working experience. The quick-connect locking system offers a one-handed, flexible way to magnify or illuminate your Gun DIY® projects while watching your favorite gunsmith.

NEW ITEM # AVMVACC | MSRP \$99.99

180 LUMEN WORK LIGHT
3 SELECTABLE SETTINGS TO ILLUMINATE DARK, HARD-TO-SEE AREAS.



5-INCH MAGNIFYING GLASS
GREAT FOR MAGNIFYING DELICATE TASKS.

PATENT
realavid.com/pat

QUICK-CONNECT SMART-DOCK SYSTEM

CELL PHONE HOLDER
A HANDS-FREE WAY TO WATCH OR CREATE HOW-TO VIDEOS.

ATTACHES TO YOUR WORKBENCH

SMART ASSIST ACCESSORY SYSTEM

WORKS ON THE REAL AVID MASTER GUN VISE®, MASTER GUN WORKSTATION®, MOBILE WORKSTATION OR MOUNTS TO YOUR BENCH.



ATTACHES TO MASTER GUN VISE



ATTACHES TO MASTER GUN WORKSTATION

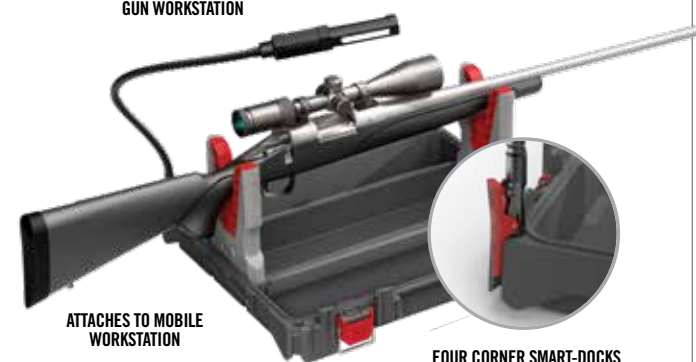

ATTACHES TO MOBILE WORKSTATION

FOUR CORNER SMART-DOCKS

NEW

DOCKING SYSTEMS QUICKLY CONNECT SMART-ASSIST ACCESSORIES WHENEVER AND WHEREVER YOU NEED THEM.

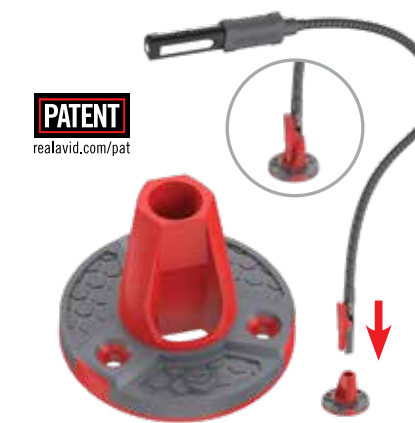

PATENT
realavid.com/pat

SMART-ASSIST SURFACE MOUNT
3-PACK SURFACE AND FLUSH MOUNT.

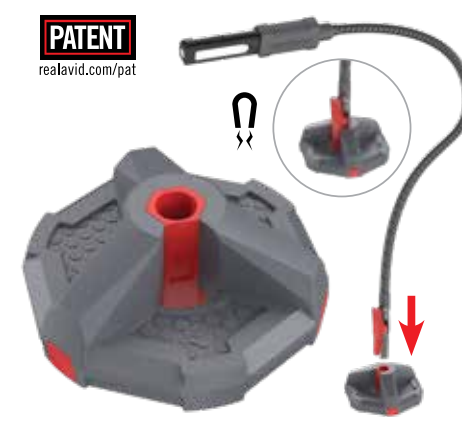

PATENT
realavid.com/pat

SMART-ASSIST MAGNETIC MOUNT
HANDS-FREE MAGNETIC MOUNTABLE SMART-ASSIST DOCK.



PATENT
realavid.com/pat

SMART-ASSIST C-MOUNT
UP-TO 2-1/4" MOUNTING CAPACITY FOR A SECURE FIT.

SMART-ASSIST™ DOCKING MOUNTS

Smart-Assist Docking Mounts redefine hands-free efficiency. The Surface Mount 3-Pack optimizes space with a reversible design, attaching to multiple surfaces for instant assistance. The Magnetic Mount, with six strong magnets, offers hands-free enhancement on steel surfaces. The C-Mount guarantees a stable fit on flat edges, with reversible mounting and four Smart-Docks™ for customized assistance. Upgrade your workspace with Smart-Assist for seamless, intelligent work assistance and enhanced productivity.

NEW SMART-ASSIST — SURFACE MOUNT - 3 PACK
NEW SMART-ASSIST — MAGNETIC MOUNT
NEW SMART-ASSIST — C-MOUNT

ITEM # AVSADM
ITEM # AVSADM
ITEM # AVSADM

MSRP \$19.99
MSRP \$29.99
MSRP \$24.99

COMPATIBLE WITH SMART ASSIST ACCESSORIES



180 LUMEN WORK LIGHT
5-INCH MAGNIFYING GLASS
CELL PHONE HOLDER
(ACCESSORIES NOT INCLUDED - SOLD SEPARATELY)



WE ARE MASTER GRADE.®

HIGH-PERFORMANCE TOOLS FOR GUNS

Redefining the landscape of gun tools, Real Avid sets the standard with advanced capability and professional insight, earning the trust of GUN DIYers, professional armorers and gunsmiths alike. Real Avid elevates your firearm maintenance and customization with the best tools for the job.



THE FIRST EVER TRUE GUN VISE.

PATENT
realavid.com/pat



COMPATIBLE WITH
SMART ASSIST
ACCESSORIES



180 LUMEN WORK LIGHT
5-INCH MAGNIFYING GLASS
CELL PHONE HOLDER

(180 LUMEN WORK LIGHT, 5-INCH MAGNIFYING GLASS AND CELL PHONE HOLDER NOT INCLUDED - SOLD SEPARATELY)

MULTI-AXIS BENCH-MOUNT VISE WITH TORQ-LOK™



Angle the lower receiver for fast and easy installation of bolt release pin.



Optimally position lower receiver to install buffer and buffer detent pin.



Ideal positioning for inverted maintenance and installations.

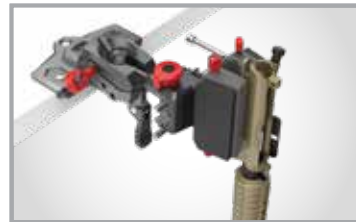

Position the barrel and upper receiver downward into the trash for bore and barrel cleaning.



Position the lower receiver to install pivot pin, spring & detent. (Smart-Fit® AR15 Vise Block sold separately)



Optimal lock-down positioning for high-torque applications. (Lug-Lok Upper Vise Block™ sold separately)

MASTER GUN VISE®

The first real bench vise made exclusively for guns and gun tools. Whether you're building and customizing, repairing and cleaning or mounting scopes and accessories, this vise improves every part of the GUN DIY® experience. Quickly reposition your gun to any orientation without ever removing it from the vise. Insert the Torq-Lok™ pin for applying heavy force. Use the removable and reversible Smart-Jaws™ – Gun-Fit™ sleeves for a specific gun grip or turn the leveling knob for simple scope mounting and leveling. Build. Customize. Repair. Mount. Clean... All hail the king.

ITEM # AVARAMV | MSRP \$299.99

THE ULTIMATE FOUNDATION FOR GUN DIY®.

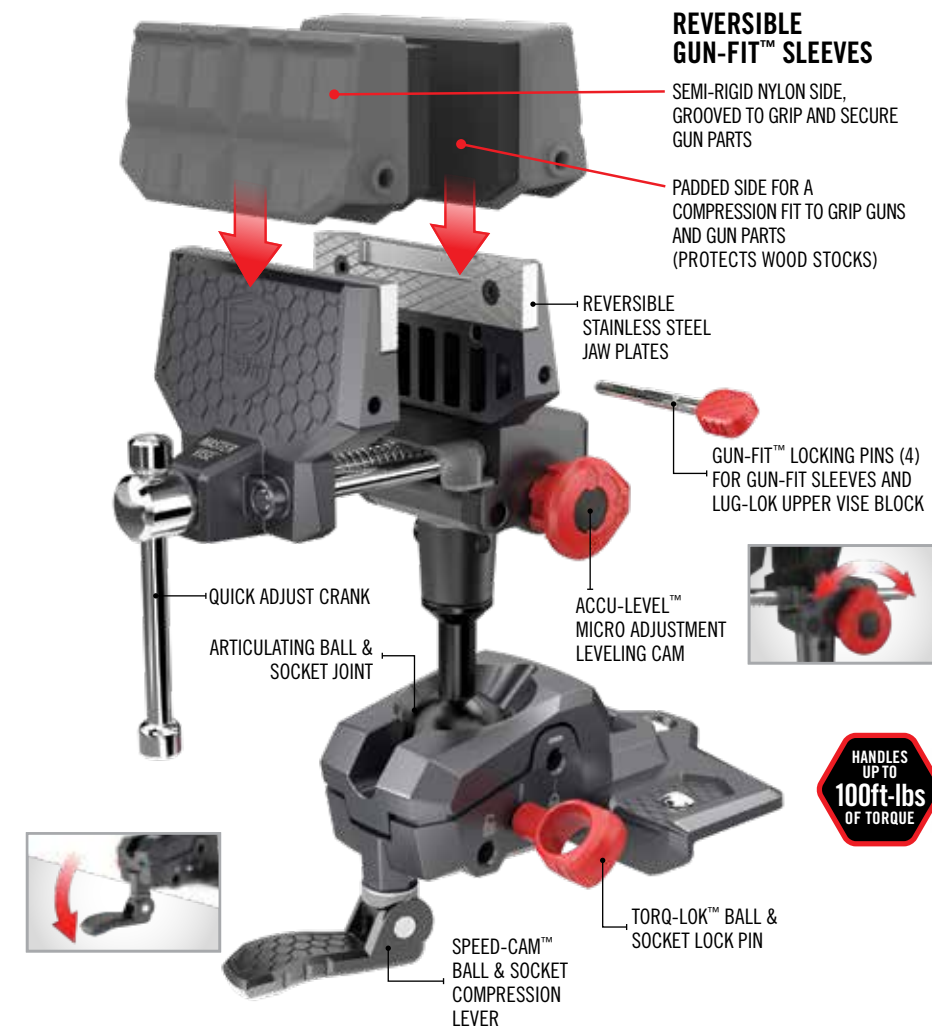

REAL AVID® TOOLS THAT THE MASTER GUN VISE IS DESIGNED TO PAIR WITH



Vise jaws integrate seamlessly with the Smart-Fit® AR15 Vise Block. (Smart-Fit sold separately)



Securely anchor Lug-Lok Upper Vise Block™ with Gun-Fit™ locking pins. (Lug-Lok sold separately)

PERFECT FOR THE AR15 – GREAT FOR ANY GUN



The versatile and modular Gun-Fit sleeves allow nearly any gun or gun part to be safely and securely clamped in the vise for unlimited Gun DIY® tasks.

NEW

UPGRADE VISE JAWS FOR SPECIFIC JOBS.

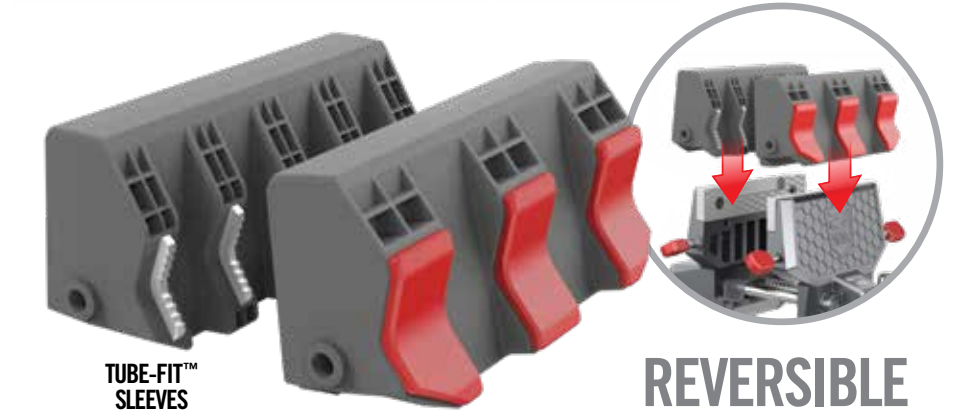
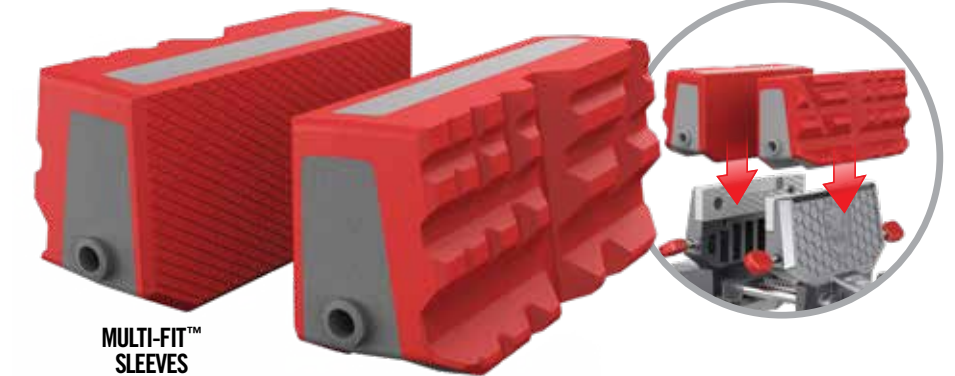

REVERSIBLE JAW SLEEVES.

PATENT
realavid.com/pat

SMART-JAWS™ FOR MASTER GUN VISE®

Different jobs require a different gripping surface for your vise. Upgrade your Master Gun Vise with the new Smart-Jaws – Multi-Fit Sleeves for most long guns, pistols, barrels and guide rods. These non-marring thermoplastic rubber jaws work on all sizes and shapes of guns and parts. For cylindrical objects like suppressors, PVC, cast-iron pipe and all types of tubing, upgrade to the new Smart-Jaws – Tube-Fit Sleeves. The non-marring thermoplastic rubber side is great for suppressors and barrels. Use the hard-gripping metal side for tough jobs like cast-iron pipe for the ultimate grip.

SMART-JAWS — MULTI-FIT SLEEVES
SMART-JAWS — TUBE-FIT SLEEVES

ITEM # AVSFJMF
ITEM # AVSFJPF

MSRP \$34.99
MSRP \$44.99

THE MOST CAPABLE SET OF MASTER GRADE® AR15 TOOLS EVER ASSEMBLED.



PATENT
realavid.com/pat

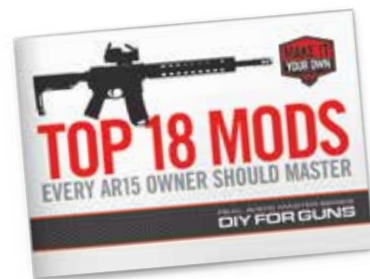

INCLUDED FREE
STEP-BY-STEP, DETAILED
INSTRUCTIONS FOR THE
TOP 18 AR15 MODIFICATIONS

- Accu-Punch® Hammer
- Master-Fit® Wrench Set
- Master-Fit Torque Wrench
- Lug-Lok Upper Vise Block™
- Smart-Fit® AR15 Vise Block
- Master Bench Block® - AR15
- Easy-Grip™ Handguard Tool
- AR15 Pivot Pin Tool
- AR15 Pin Punch Set
- Pin Alignment Tool
- Professional Tool Case

COMPREHENSIVE MASTER GRADE AR15 TOOL SET PLUS
DETAILED INSTRUCTIONS FOR POPULAR GUN DIY® PROJECTS.

ARMORER'S MASTER KIT® - AR15 PRO

This upgraded kit is the most capable set of Master Grade AR15 tools ever assembled to build, repair or customize your gun, housed in a convenient, professional case. Featuring an extensive set of task-specific crowfoot wrenches for the most common AR15 assembly nuts and a heavy-duty armorer's torque wrench. Kit includes both upper and lower vise blocks to confidently secure your gun parts for superior control. A comprehensive set of AR15 pin punches and armorer's hammer pair with the 11-function bench block. To get you started, a step-by-step instructional book is included to guide you through the top 18 modifications made to AR15s. Upgrade to Master Grade®!

ITEM # AVAMKPRO | MSRP \$479.99

THE #1 SELLING ARMORER'S KIT.

- Armorer's Master Wrench® with Replacement Hammer Heads
- Lug-Lok Upper Vise Block™
- Smart-Fit® AR15 Vise Block
- Master Bench Block® - AR15
- Torque Wrench
- Easy-Grip™ Handguard Tool
- AR15 Pivot Pin Tool
- AR15 Pivot Lock
- AR15 Pin Punch Set
- Pin Alignment Tool
- Accu-Grip™ Picks
- Bore Illuminator/Safety Flag
- Front Sight Adjuster Tool
- Professional Tool Case



PATENT
realavid.com/pat

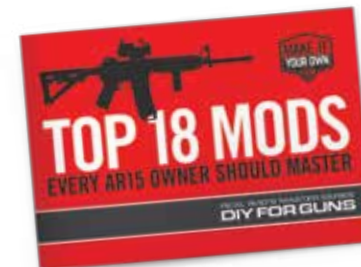

INCLUDED FREE
STEP-BY-STEP, DETAILED
INSTRUCTIONS FOR THE
TOP 18 AR15 MODIFICATIONS

ADVANCED MASTER GRADE® TOOLS PLUS DETAILED GUN DIY®
INSTRUCTIONS TO CUSTOMIZE YOUR AR15.

ARMORER'S MASTER KIT® - AR15

This kit of Master Grade Tools and how-to information equips you to confidently tackle everything from building your own gun from the ground up to customizing or modifying an existing gun. With better tolerances, materials and expanded capability, every tool is carefully designed to make each job as simple and easy to execute as possible. Housed in a professional tool case and equipped with step-by-step instructions, you will be able to work smarter and create better guns regardless of your experience level.

ITEM # AVAR15AMK | MSRP \$279.99

“HOW-TO” FOR GUNS MADE SIMPLE.

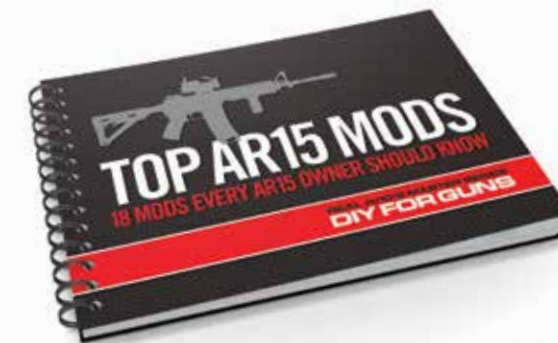

STEP-BY-STEP,
DETAILED INSTRUCTIONS
FOR THE TOP 18 AR15
MODIFICATIONS



18 MODS EVERY AR15
OWNER SHOULD KNOW



TOP AR15 MODS

To serve the huge base of AR15 owners who are fueling the growth of aftermarket accessories, we created a master Gun DIY® instruction manual. It's packed with easy-to-follow, photo illustrated, step-by-step, how-to-do-it directions for the 18 most popular modifications for AR15s. This authoritative book gives users the confidence and know-how to tackle everything from a simple sight install to the more challenging changing out of a barrel...and everything in between.

ITEM # AVTOPMODS | MSRP \$29.99

OBSOLETE PRETENDERS AND ESTABLISHES THE NEW STANDARD FOR ARMORER'S TOOLS.

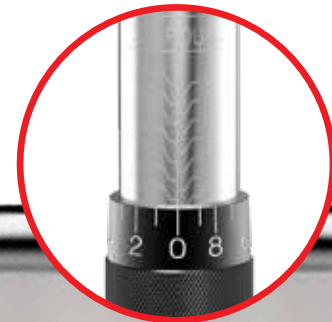

HEAVY-DUTY WRENCH FEATURES A 10 TO 150 FOOT POUND RANGE.

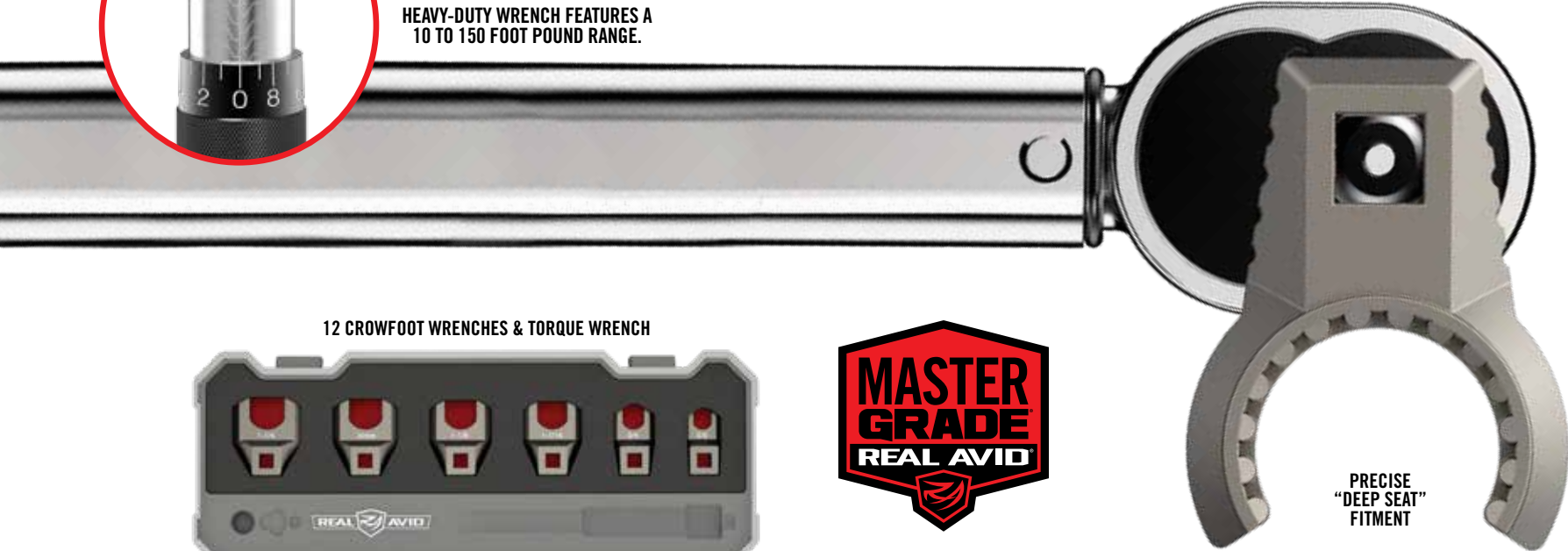

SOLID NUT-GRIPPING STRENGTH AND ENHANCED NO-SLIP CONTROL



TITANIUM-COATED STAINLESS STEEL CONSTRUCTION

PRECISE "DEEP SEAT" FITMENT

WORLD'S FIRST PROFESSIONAL-GRADE CROWFOOT ARMORER WRENCHES.



MASTER-FIT® 13-PIECE AR15 CROWFOOT WRENCH SET

The most comprehensive all-in-one AR15 Armorer's Torque Wrench Kit ever assembled. Master-Fit single-purpose crowfoot wrenches are made specifically for the job. Specialized for precise fitment and manipulation of MIL-SPEC and free-float barrel nuts, muzzle devices and castle nuts. Titanium-coated stainless steel construction provides tight tolerances for solid nut-gripping strength and enhanced no-slip tool control. Paired with the heavy-duty Master-Fit Torque Wrench, it takes Gun DIY® building to a new level of Master Grade quality and precision. It's time to raise your Gun Tool™ expectations and Upgrade to Master Grade®!

ITEM # AVMF13WS | MSRP \$299.99



ORGANIZED AND PROFESSIONAL SECURE TOOL STORAGE

DESIGNED SPECIFICALLY FOR GUN NUTS.

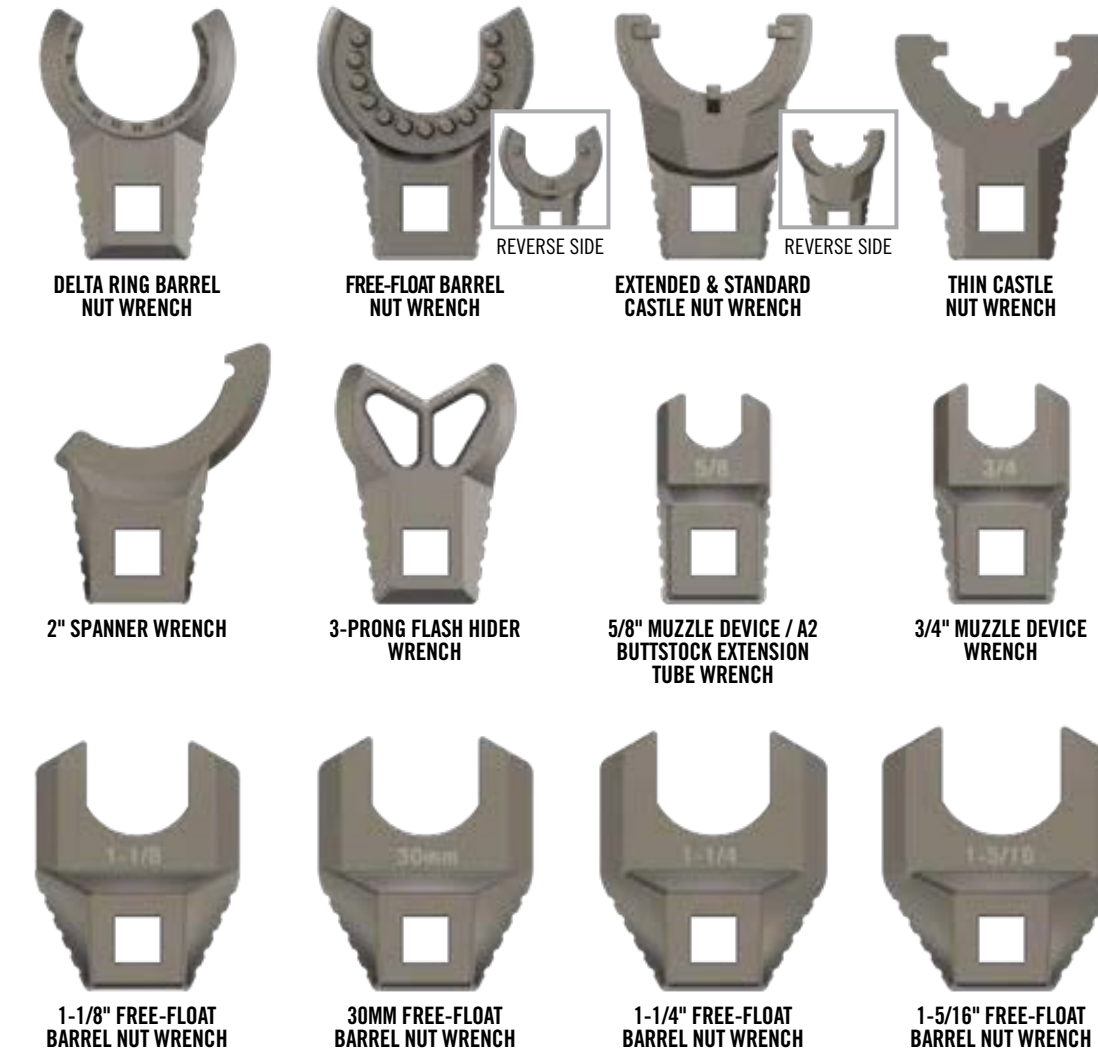

SPECIALIZED WRENCHES FIT MOST COMMON AR15 ASSEMBLY NUT SIZES.

4 CROWFOOT WRENCHES & TORQUE WRENCH



MASTER GRADE A2/AR15 WRENCHES & TORQUE WRENCH

MASTER-FIT® 5-PIECE A2 CROWFOOT WRENCH SET

This Master-Fit crowfoot wrench set is specialized for precise fitment and manipulation of A2 barrel nuts, buttstocks, muzzle devices and castle nuts. Titanium-coated stainless steel construction provides tight tolerances for solid nut gripping strength and enhanced no-slip fitment. Paired with the heavy-duty Master-Fit Torque Wrench, it takes Gun DIY® building to a new level of Master Grade quality and precision.

ITEM # AVMF5WS | MSRP \$149.99

MASTER GRADE® AR15 CROWFOOT ARMORER'S WRENCHES

MASTER-FIT WRENCH HEADS

Now you can say, "I've got a wrench for that!" No more rigging and adapting generic wrenches to complete your builds. Master-Fit 1/2" Drive Crowfoot Wrenches are purpose built and specialized for precise fitment to confidently deliver torque to the most common MIL-SPEC and standard assembly nuts. Titanium-coated stainless steel construction provides tight tolerances for solid nut-gripping strength and enhanced no-slip tool control.

DELTA RING BARREL NUT WRENCH	ITEM # AVMFDRBNW	MSRP \$29.99
FREE-FLOAT BARREL NUT WRENCH	ITEM # AVMFFBPNW	MSRP \$29.99
EXTENDED & STANDARD CASTLE NUT WRENCH	ITEM # AVMFESCNW	MSRP \$29.99
THIN CASTLE NUT WRENCH	ITEM # AVMFTCNW	MSRP \$29.99
2" SPANNER WRENCH	ITEM # AVMF2SW	MSRP \$29.99
3-PRONG FLASH HIDER WRENCH	ITEM # AVMF3PFHW	MSRP \$29.99
5/8" MUZZLE DEVICE / A2 BUTTSTOCK EXTENSION TUBE WRENCH	ITEM # AVMF58MDW	MSRP \$29.99
3/4" MUZZLE DEVICE WRENCH	ITEM # AVMF34MDW	MSRP \$29.99
1-1/16" FREE-FLOAT BARREL NUT WRENCH	ITEM # AVMF116BNW	MSRP \$29.99
1-1/8" FREE-FLOAT BARREL NUT WRENCH	ITEM # AVMF118BNW	MSRP \$29.99
30MM FREE-FLOAT BARREL NUT WRENCH	ITEM # AVMF30BNW	MSRP \$29.99
1-1/4" FREE-FLOAT BARREL NUT WRENCH	ITEM # AVMF114BNW	MSRP \$29.99
1-5/16" FREE-FLOAT BARREL NUT WRENCH	ITEM # AVMF1516BNW	MSRP \$29.99

MASTER GRADE® ARMORER'S WRENCH FOR GUN DIY.®

PATENT
realavid.com/pat



FREE-FLOAT BARREL NUT WRENCH (FEATURES 10 POSTS FOR BEST-IN-CLASS STRENGTH)



REVERSE SIDE OF MIL-SPEC BARREL NUT WRENCH

ERGONOMIC DESIGN LETS YOU APPLY TORQUE WITHOUT HURTING YOUR HAND

ARMORER'S MASTER WRENCH®

The Real Avid Armorer's Master Wrench features best-in-class strength, precision fitment and ergonomic intelligence. Wrenches seat squarely for a no-slip fit on stubborn barrel nuts, castle nuts, muzzle brakes and fixed stock receiver extensions. Industry-first torque wrench attachment location is optimally positioned to provide consistent torque poundage for all nuts. As a bonus, interchangeable hammer heads make the Armorer's Master Wrench a "Master" hammer as well!

ITEM # AVAR15AMW | MSRP \$79.99

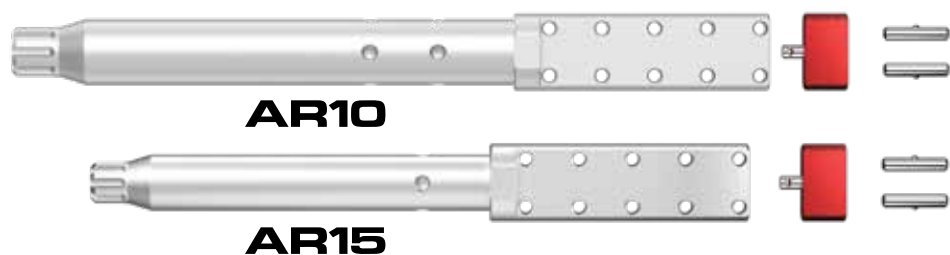

PATENT
realavid.com/pat

LUG-LOK UPPER VISE BLOCK™

We designed an upper block that leverages the strongest part of the gun – the barrel lugs inside the star chamber. The Lug-Lok is precision machined and precisely fits into all MIL-SPEC uppers. It mates perfectly with the barrel lugs, while allowing you to rotate the upper to be able to work on different sides.

LUG-LOK UPPER VISE BLOCK - AR15
LUG-LOK UPPER VISE BLOCK - AR10

ITEM # AVAR15LLVB MSRP \$79.99
ITEM # AVAR10LLVB MSRP \$119.99

**DISCLAIMER: This product is not manufactured, authorized, endorsed, or warranted by ArmaLite, Inc. ArmaLite, Inc. does not warrant or represent that this product is compatible with AR-10. "AR-10" is a federally registered trademark of ArmaLite, Inc. New Revo Brand Group, LLC, d/b/a Real Avid is not affiliated in any manner with, or otherwise endorsed by ArmaLite, Inc.



PATENT
realavid.com/pat

EXPANDS TO SECURELY FIT AR MAGWELLS.

SMART-FIT® AR15 VISE BLOCK WITH SLEEVE FOR AR10**

The Smart-Fit AR15 Vise Block and Vise Block Sleeve for AR10, DPMS LR-308 and SR-25 is the best lower receiver vise block you'll ever use. Magwell sizes have a notoriously wide range of tolerances, and traditional blocks create wiggle and wobble on a gun vise. Smart-Fit's design solves that. It expands to fit all MIL-SPEC AR15s, AR10s and similar magwells, making loose, sloppy-fitting blocks a thing of the past.

NEW ITEM # AV1015SFVB | MSRP \$49.99

SMART-FIT VISE BLOCK SLEEVE FOR AR10**

The Smart-Fit Vise Block Sleeve for AR10 was designed to slide over the Real Avid Smart-Fit AR15 Vise Block to help eliminate wobble when working on large frame rifles.

NEW ITEM # AVAR10SFVBS | MSRP \$19.99



EXPANDS TO SECURELY FIT ALL MIL-SPEC AR15 MAGWELLS

LOWER RECEIVER BLOCK THAT ADJUSTS FOR A ROCK SOLID FIT

SMART-FIT AR15 VISE BLOCK

The Smart-Fit AR15 Vise Block is the last lower vise block you'll ever need. The patented block expands to fit any .223 cal / 5.56mm AR15 magwell, making loose, sloppy fitting blocks a thing of the past. Insert the block into the magazine well and simply rotate the adjustment handle to tighten the fit.

ITEM # AVAR15SFVB | MSRP \$39.99

NOT COMPATIBLE WITH AR10B



AR10 SLEEVE SLIDES OVER AR15 VISE BLOCK



PLUS AR15 PIVOT LOCK SECURELY HOLDS UPPER OPEN FOR CLEANING

PATENT
realavid.com/pat

NEW

PROFESSIONAL ARMORER'S HAMMER.



PIN STARTER FITS 1/16" TO 7/32" 1.8MM TO 7.14MM



INTEGRATED MAGNETIC PIN STARTER



PATENT
realavid.com/pat

ARMORER'S MASTER HAMMER™

Tested and influenced by gunsmiths, the Armorer's Master Hammer is a 22-ounce, 9-1/2" long, forged hammer with full-length tang for a perfect balance and ideal ergonomics for precise control. A removable soft blow hammer head cover and interchangeable hammer heads with integrated storage makes it easy to install the correct hammer head for the application. Stored in the handle is a removable, stainless steel, magnetic pin starter to provide a helping hand when building or modifying firearms.

NEW ITEM # AVARMHAM | MSRP \$69.99

NEW

ARMORER'S MASTER HAMMER AND 11-PIECE STANDARD PIN PUNCH SET.



PIN STARTER FITS 1/16" TO 7/32" 1.8MM TO 7.14MM

INTEGRATED MAGNETIC PIN STARTER



PATENT
realavid.com/pat

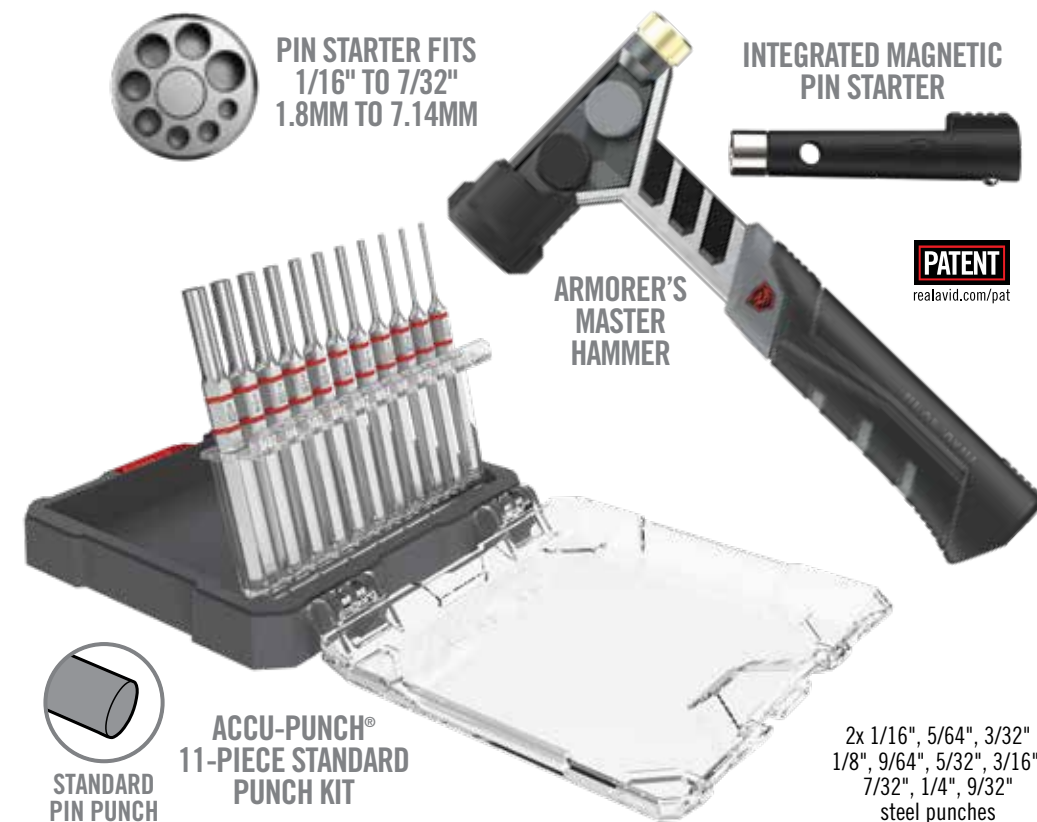

ARMORER'S MASTER HAMMER

STANDARD PIN PUNCH

ACCU-PUNCH® 11-PIECE STANDARD PUNCH KIT

2x 1/16", 5/64", 3/32", 1/8", 9/64", 5/32", 3/16", 7/32", 1/4", 9/32" steel punches

ARMORER'S MASTER HAMMER™ AND ACCU-PUNCH® 11-PIECE STANDARD PIN PUNCH SET

The Armorer's Master Hammer and Accu-Punch 11-piece Standard Pin Punch set, meticulously crafted for expert gunsmiths. The Armorer's Master Hammer boasts a balanced 22-ounce forged hammer with a full-length tang for precision control. It comes with interchangeable hammer heads and a magnetic pin starter for effortless adaptation and accurate firearm modifications. The Accu-Punch set features hardened steel punches with nickel plating for corrosion resistance and a hex-shaped handle with O-rings for precise control. Elevate your gunsmithing with these essential tools, designed for unmatched precision and durability.

NEW ITEM # AVAMHAPS | MSRP \$89.99

DESIGNED FROM THE GROUND UP TO WORK BETTER ON GUNS.

GUNSMITHING PIN PUNCH SETS WITH PIN ALIGNMENT TOOL.



STANDARD PIN PUNCH SET

STANDARD

COMPLETE SET OF STANDARD-SIZED GUN PIN PUNCHES

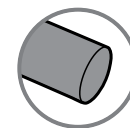

STANDARD PIN PUNCH

- Gunsmithing hammer with rubberized, ergonomic grip
- 4 interchangeable hammer heads: rubber, brass, steel & nylon
- Pin Alignment Tool
- 1/16", 5/64", 3/32", 1/8", 9/64", 5/32", 3/16", 7/32", 1/4", 9/32" steel punches
- 5/16" nylon finishing punch
- Stand-up case

ITEM # AVHPS | MSRP \$39.99



STANDARD BRASS & STEEL PIN PUNCH SET

BRASS & STEEL

COMPLETE SET OF STANDARD-SIZED GUN PIN PUNCHES

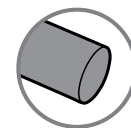

STANDARD PIN PUNCH

- Gunsmithing hammer with rubberized, ergonomic grip
- 4 interchangeable hammer heads: rubber, brass, steel & nylon
- Pin Alignment Tool
- 1/16", 5/64", 3/32" steel punches and 1/8", 9/64", 5/32", 3/16", 7/32", 1/4", 9/32" brass punches
- 5/16" nylon finishing punch
- Stand-up case

ITEM # AVHPS-B | MSRP \$49.99



ROLL PIN PUNCH SET

ROLL PIN

INCLUDES ALL STANDARD-SIZED ROLL PIN PUNCHES NEEDED FOR GUNS

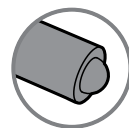

ROLL PIN PUNCH

- Gunsmithing hammer with rubberized, ergonomic grip
- 4 interchangeable hammer heads: rubber, brass, steel & nylon
- Pin Alignment Tool
- Roll pin punches 1/16", 5/64", 3/32", 1/8", 9/64", 5/32", 3/16", 7/32", 1/4"
- 5/16" nylon finishing punch
- Stand-up case

ITEM # AVHPS-RP | MSRP \$39.99



STANDARD & ROLL PIN PUNCH SET FOR AR15

AR15

INCLUDES EVERY STANDARD & ROLL PIN PUNCH FOR AR15

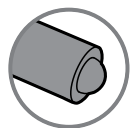

ROLL PIN PUNCH

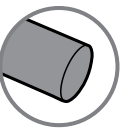

STANDARD PIN PUNCH

- Gunsmithing hammer with rubberized, ergonomic grip
- 4 interchangeable hammer heads: rubber, brass, steel & nylon
- Pin Alignment Tool
- Standard pin punches 3/32", 1/8", 5/32"
- Roll pin punches 1/16", 5/64", 1/8"
- Staking punch
- 3/32" bolt catch roll pin starter & roll pin punch
- 5/16" nylon finishing punch
- Stand-up case

ITEM # AVHPS-AR | MSRP \$39.99

ACCU-PUNCH® HAMMER & PIN PUNCH SETS

Gunsmithing hammers and punches are core tools needed to modify or disassemble firearms. Most sets available today are generic, repurposed hardware sets. Accu-Punch Hammer & Punch Sets are designed from the ground up to work better on guns. The hammer features an ergonomic grip and perfectly-balanced weight to give both precise control for tapping tiny pins and optimal force for those that need a little "persuasion". Punches are made of hardened steel with a nickel plating to resist corrosion as well as hex-shaped handles and rubber O-rings for precise control. The proprietary Pin Alignment Tool makes aligning and starting tiny pins both easy and accurate. These professional-grade gunsmithing sets are organized in an uber-tough stand-up case.

NEW

THE MOST FREQUENTLY USED GUNSMITHING PIN PUNCHES.



STANDARD



ROLL PIN



BRASS & STEEL

ACCU-PUNCH® 11-PIECE PUNCH SETS

The Accu-Punch 11-Piece Punch Sets are the go-to gunsmithing pin punches for firearm enthusiasts. Crafted from hardened steel with a corrosion-resistant nickel plating, these Master Grade® sets ensure precise control with hex-shaped handles and rubber O-rings. These comprehensive kits are labeled, housed in a sturdy case and cater to every firearm modification need. Elevate your gunsmithing experience with the Accu-Punch 11-Piece Punch Sets—precision and durability at your fingertips.

NEW ACCU-PUNCH 11-PIECE STANDARD PIN SET

NEW ACCU-PUNCH 11-PIECE ROLL PIN SET

NEW ACCU-PUNCH 11-PIECE STANDARD BRASS & STEEL PIN SET

ITEM # AVAPK-S

ITEM # AVAPK-RP

ITEM # AVAPK-B

MSRP \$29.99

MSRP \$29.99

MSRP \$39.99

PATENT

realavid.com/pat

BOLT CATCH PUNCH SET

Two punches, one simple solution to the difficult-to-access bolt catch retaining pin. The orientation of the pin, close proximity to the lower receiver, distance required to safely punch a pin and the difficulty in getting the pin started makes it a real pain with standard punches.

ITEM # AVBCPS | MSRP \$14.99

SPECIALIZED AR15 BOLT CATCH PIN STARTER & PIN PUNCH SET



INCLUDES EVERY STANDARD & ROLL PIN PUNCH FOR GUNS

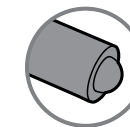

ROLL PIN PUNCH

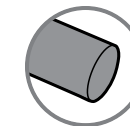

STANDARD PIN PUNCH

- Standard pin steel punches 1/16", 5/64", 3/32", 1/8", 9/64", 5/32", 3/16", 7/32", 1/4", 9/32"
- Roll pin punches 1/16", 5/64", 3/32", 1/8", 9/64", 5/32", 3/16", 7/32", 1/4", 9/32"
- Brass pin punches 1/8", 9/64", 5/32", 3/16", 7/32", 1/4", 9/32"
- 3/32" bolt catch roll pin starter & roll pin punch
- Staking punch
- 5/16" nylon finishing punch
- Pin Alignment Tool

ACCU-PUNCH® MASTER SET

Gunsmithing punches are core tools needed to modify or disassemble firearms. Accu-Punch Master Set with standard, roll pin, brass and specialty punches is designed from the ground up to work better with firearms. Non-brass punches are made of hardened steel with a nickel plating to resist corrosion. All punches have hex-shaped handles and rubber O-rings for precise control. The proprietary Pin Alignment Tool makes aligning and starting tiny pins both easy and accurate.

ITEM # AVMAPS | MSRP \$99.99

NEW

PIN PUNCHING MADE EASY.

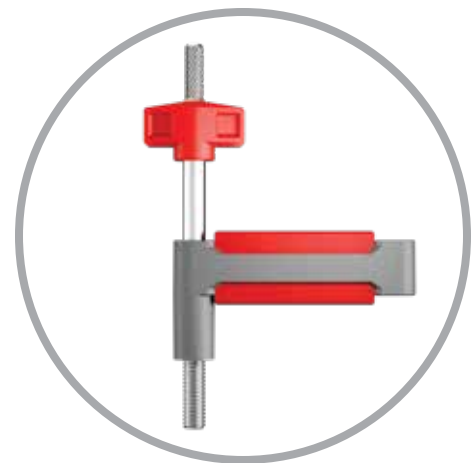

SMART-BLOCK CLAMPS FIRMLY HOLD PARTS IN PLACE, ENSURING STABILITY DURING PIN PUNCHING.



14 HOLES AND 2 GROOVES POSITIONED OPTIMALLY FOR FLEXIBILITY

CONSTRUCTED FROM HIGH-QUALITY ENGINEERING-GRADE RESIN

PATENT
realavid.com/pat



MASTER BENCH BLOCK® PRO

With 14 strategically placed holes, 2 grooves and a larger design, precise pin alignment is made easy for all firearms. This block was constructed with upmost attention to detail for those looking to clean, repair or modify their firearms. The three elongated slots quickly align with compact size to full size pistols. Both the vertical and horizontal grooves offer the properly needed length and cutouts for work to be performed on long and short action bolts. To help secure parts, frames or barrels firmly in place, two Smart-Block Clamps have been incorporated into the block, allowing the end user to focus purely on the task at hand. Mounted inside are two strong magnets that grasp any pin you punch out and hold it securely to the block.

NEW ITEM # AVMBBPRO | MSRP \$39.99

NEW

ALL-IN-ONE BENCH BLOCK, HAMMER AND PUNCH SET.

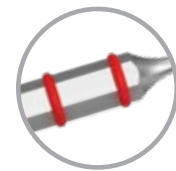

HEX-SHAPED HANDLES AND RUBBER O-RINGS FOR PRECISE CONTROL.

SMART-BLOCK CLAMPS FIRMLY HOLD PARTS IN PLACE, ENSURING STABILITY DURING PIN PUNCHING.

14 HOLES AND 2 GROOVES POSITIONED OPTIMALLY FOR FLEXIBILITY

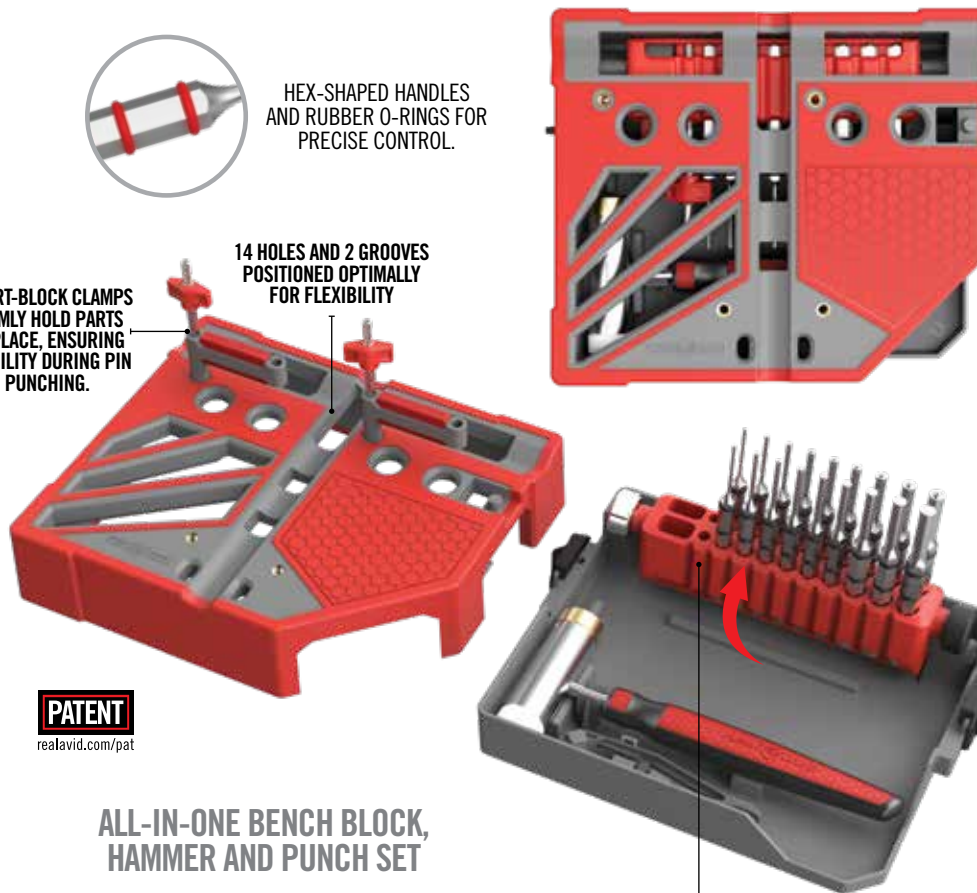

PATENT
realavid.com/pat

ALL-IN-ONE BENCH BLOCK, HAMMER AND PUNCH SET

REMOVABLE FLIP-UP PIN PUNCH STORAGE

MASTER BENCH BLOCK PRO-KIT

The Master Bench Block Pro-Kit is a comprehensive pin punching solution that simplifies your work. This all-in-one set includes 18 hardened steel punches and an ergonomic hammer with interchangeable heads stored within a spacious bench block. With 14 strategically placed holes, 2 grooves and a larger design, precise pin alignment is made easy for all firearms. The three elongated slots quickly align with compact size to full size pistols. To help secure parts, frames or barrels firmly in place, two Smart-Block Clamps have been incorporated into the block, allowing the end user to focus purely on the task at hand. When the work is done, store all your tools into the integrated storage tray for an easy storage solution.

NEW ITEM # AVMBBPKIT | MSRP \$79.99

THE MOST COMPREHENSIVE AR15 BENCH BLOCK, EVER.



T-HANDLE COMPRESSES EJECTOR TO EASILY REMOVE EJECTOR PIN

HOLDS 5 KEY GUN PARTS TO EASILY REMOVE & INSTALL PINS

PATENT
realavid.com/pat

MASTER BENCH BLOCK® - AR15

The Master Bench Block - AR15 holds 5 key AR15 components in 8 different orientations to allow you to knock out and install up to 14 different pins. Clear, engraved labels tell you what component fits where, and what size punch you'll need to knock out the pins. The biggest innovation is mounted inside – four strong magnets immediately grasp any pin you punch out and hold it securely to the block.

ITEM # AVAR15MBB | MSRP \$39.99

NON-SLIP, MAGNETIC UNIVERSAL PIN PUNCH BLOCK



PATENT
realavid.com/pat

SMART BENCH BLOCK®

Made from engineering-grade resin, this intelligently-designed gunsmith block helps protect gun finishes. The non-slip outer ring keeps the block from sliding on tables or benches while driving pins. An embedded magnet captures and holds driven pins so that they won't roll away. A rounded slot seats barrels and gun slides for increased stability. Designed to work with most guns.

ITEM # AVSBBLK | MSRP \$14.99

PRECISION TORQUE DRIVER FOR FIREARMS.



EASY-TO-SELECT
PRECISE 1 INCH-LB
INCREMENTS ELIMINATES
THE GUESSWORK OF
OTHER WRENCHES



INCLUDES PREMIUM
HIGH-DENSITY FOAM
STORAGE CASE



ONE CLICK
EQUALS
1 INCH-LB
10 TO 70 IN-LBS

MASTER GRADE 10-70 INCH-LB TORQUE DRIVER

SMART-TORQ®

The most precise and technically-advanced torque driver for guns. Specifically developed for optics mounting and gun builds. Discrete inch-pound increment settings provide spot-on torque adjustments. Comfortable ergonomic grip, palm-friendly spin top and Force Assist make precise torque adjustments easy. Functionally-intuitive torque setting with visual, tactile and audible feedback provides assurance. To get you started, Smart-Torq comes with 12 of the most commonly used scope mounting and gun bits. Never over torque a scope ring again!

ITEM # AVSTORQ | MSRP \$79.99

BIT SET FITS MOST
OPTIC MOUNTING RINGS
AND BASE BRANDS



INCLUDED BITS

- T10
- T15
- T20
- T25
- 3mm Hex
- 5/32 Hex
- 3/16 Hex
- 7/64 Hex
- 90-6 Flat
- 38-4 Flat
- 60-5 Flat
- Square drive adapter bit

FORCE ASSIST™ DRIVER



FORCE ASSIST TECHNOLOGY HELPS TO PRECISELY TIGHTEN SCREWS

The ergonomic, rubberized grip partnered with Force Assist makes tightening screws and fasteners to precise torque settings accurate and easy.

ADVANCED GUNSMITHING DRIVER WITH FORCE ASSIST.™

87 STANDARD & METRIC
BLACK OXIDE-COATED SQUARE CUT
HOLLOW GROUND GUN BITS

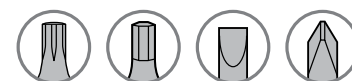

PALM-FRIENDLY SPIN
TOP, COMFORTABLE
ERGONOMIC GRIP



SMALL DRIVER FOR TIGHT
SPACES. DOUBLES AS
FORCE ASSIST LEVER

FORCE ASSIST TECHNOLOGY
HELPS LOOSEN STUCK
SCREWS AND PRECISELY
TIGHTEN SCREWS



90-PIECE GUNSMITHING KIT WITH FORCE ASSIST™ LED BIT DRIVER



SMART DRIVE® 90

Smart Drive 90 is an advanced gunsmithing driver set. The main driver features a magnetic bit holder, rubber grip texture, jewelers spin top & 360° LED light. It partners with the small "close quarters" driver to create Force Assist. Force Assist is a proprietary system that allows users to loosen frozen-in-place screws as well as precisely tighten screws.

ITEM # AVSD90 | MSRP \$99.99



360° LIGHT
ILLUMINATES DARK, HARD-TO-SEE SCREWS



ONE CLICK
EQUALS
1 INCH-LB
10 TO 70 IN-LBS



PRECISION MOUNT
OPTICS, GUN STOCKS
AND ACCESSORIES

MASTER GRADE® GUNSMITHING DRIVER & BIT SET.

SMART-TORQ® & DRIVER MASTER SET

This intelligently-designed Master Set includes both the Smart-Torq and Smart Drive gunsmithing drivers. With ergonomic comfort grips, both drivers fully integrate with the multi-purpose Force Assist driver. Smart-Torq features easy-to-see and set 1 in-lb increments. For non-torque applications, the Smart Drive will be your go-to for not only gunsmithing work, but any tasks around the house or shop. Smart Drive has a free-spinning cap for applying additional downward pressure and an LED light for dark spaces. Completing the set are 83 standard and metric black oxide-coated gun bits. Gun bits are hollow ground and square cut for precise fitment.

ITEM # AVSTOMS | MSRP \$149.99

THE MOST MODERN, ACCURATE & SIMPLE WAY TO MOUNT SCOPES.

MOUNT. LEVEL. SIGHT.

1. SET THE BASE – LEVEL THE RETICLE
2. TORQUE DOWN SCOPE RINGS
3. BORE SIGHT – GET ON PAPER FAST



PATENT
realavid.com/pat

MASTER GRADE® SCOPE MOUNTING & BORE SIGHTING KIT

Properly mounting a new scope requires specific tasks and tools to do the job right. First and foremost is setting your reticle level. Secondly, applying the correct torque to the ring and base screws to stabilize the mount without crushing the tube. Lastly, is sighting in and getting on paper fast to save time and ammo. This kit contains the Best Tools for the Job with the Level-Right Pro, Smart-Torq and Viz-Max Bore Sighter. Upgrade to Master Grade®. Mount. Level. Sight.

ITEM # AVMSMK | MSRP \$199.99

GET ON TARGET FASTER!

MASTER GRADE® LASER BORE SIGHTER

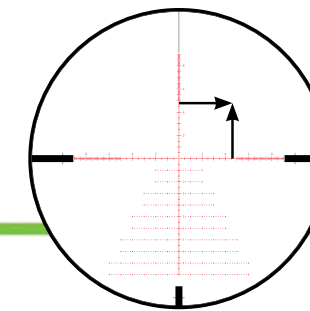

Magnetically attach Viz-Max Bore Sighter to end of bore. Use scope turrets to align crosshairs with projected beam on target. Remove and begin shooting.

PATENT
realavid.com/pat



PREMIUM HIGH-DENSITY FOAM CASE

SAVE TIME AND AMMO

VIZ-MAX BORE SIGHTER®

Viz-Max Bore Sighter is a revolutionary, yet uncomplicated next-generation instrument. No more fumbling with extra pieces and underpowered lasers to find your mark. Housed in the rugged and protective exoskeleton is a precision-machined, factory-calibrated green laser. The laser projects a powerful, perfect circle using the brightest daylight visible color in the spectrum. It provides maximum visibility and quick acquisition. The bore attachment is fast and easy with the hold-fast neodymium magnet. Features 30-second auto-off functionality.

ITEM # AVVMB5 | MSRP \$129.99

MAXIMIZE ACCURACY AT ALL DISTANCES.

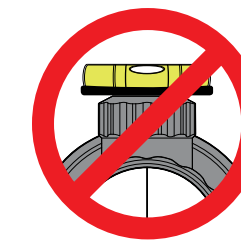

A LEVEL TURRET DOES NOT ENSURE A LEVEL RETICLE

MASTER GRADE PRECISION RETICLE LEVEL

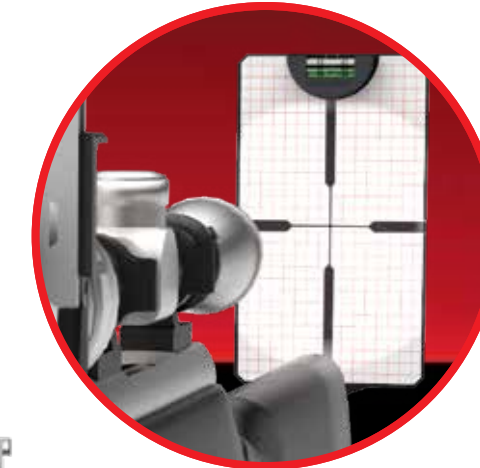

DIRECTS LIGHT SOURCE THROUGH SCOPE AND PROJECTS RETICLE ONTO PRECISION ALIGNMENT GRID



THE EASIEST, MOST ACCURATE WAY TO ENSURE YOUR SCOPE IS PROPERLY ALIGNED.

PATENT
realavid.com/pat

LEVEL-RIGHT® PRO

Correctly mounting a scope so it's level to the gun's receiver is critical to getting maximum accuracy from your rifle. A level scope means that the reticle (crosshairs) will be perfectly aligned with the rifle bore. A level reticle is critical for long-range accuracy. Balancing small levels on scope turrets and gun receivers has been a commonly-accepted practice for years. Not only is this a clumsy process, it's wrong. The turret on most scopes is not perfectly aligned with the reticle, so even if your turret is level to the gun, your scope may not be. Level-Right Pro changes all that by simplifying scope alignment in 4 easy steps. Accurate and intuitive, this time saving instrument quickly aligns the actual scope reticle to the horizontal gun plane (regardless of turret alignment), which is key to the long-range accuracy of your rifle. Level-Right Pro helps you quickly and confidently mount a scope for maximum accuracy.

ITEM # AVLVL-R-P | MSRP \$69.99

UPGRADE YOUR GUN BUILDING EXPERIENCE.



OVERSIZED, PROTECTIVE MAT WITH PARTS AND TOOL ORGANIZATION



MASTER ARMORER'S MAT*

The Master Armorer's Mat is the ultimate solution for your gun building projects. This massive mat will protect your large gun parts while the added organization trays will hold every medium and small component, making sure you don't lose any parts in the process.

ITEM # AVMAM-AR | MSRP \$44.99



ERGONOMIC AR15 DELTA RING RETRACTOR

EASY-GRIP™ HANDGUARD REMOVAL TOOL

The name says it all. Ergonomic grips make one-handed changing of handguards on AR15s and M16s a breeze. Simply hook to the empty magwell, place the contoured rods around the Delta Ring, squeeze the handles and pull down to compress the Delta Ring. Remove the handguard with your free hand. It's that simple.

ITEM # AVEGHRT | MSRP \$19.99

THE FASTEST WAY TO INSTALL A PIVOT PIN.



PIVOT PIN TOOL FOR AR10**

How can such a small task cause such frustration? The AR10 Pivot Pin Tool gives you a third hand to turn the fumble-finger, pin-launching, pain-in-the-neck task into a quick breeze. 1-2-3-4 done, it's that simple. Easily install the AR10 Pivot Pin in less than 60 seconds.

NEW ITEM # AVAR10PPT | MSRP \$19.99

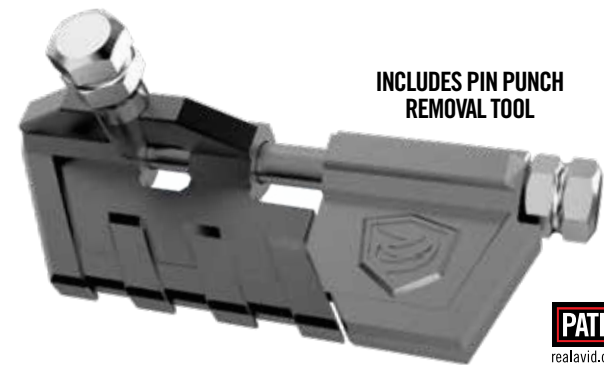

INCLUDES PIN PUNCH REMOVAL TOOL



AR15 PIVOT PIN TOOL-PRO™

Highly engineered to turn a frustrating task into a quick and painless operation. The larger, all-metal construction provides extreme durability, precise fitment and ease of use with all AR15s.

NEW ITEM # AVARPPTPRO | MSRP \$29.99

AR15 PIVOT PIN TOOL

How can such a small task cause such frustration? This brilliant little tool gives you an extra hand to turn the fumble-finger, pin-launching, pain-in-the-neck task into a quick breeze. 1-2-3-4 done, it's that simple.

ITEM # AVAR15PPT | MSRP \$11.99

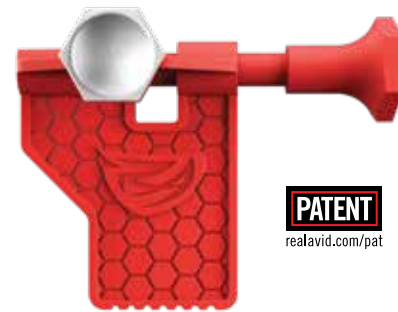

KICKS LESSER PUSHERS TO THE BACK OF THE BENCH.



PRECISION-ENGINEERED SIGHT CHANGER

REVERSIBLE PRESS BLOCK

FITS ANY DOVETAIL SLOT DOWN TO 5/32" (4MM) WIDE

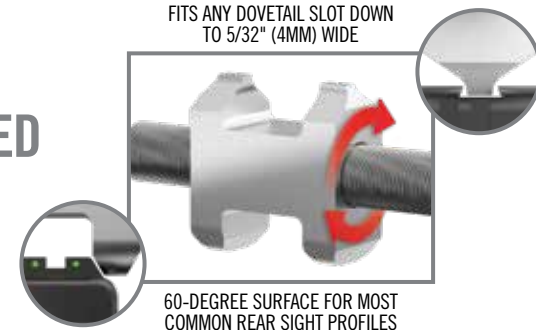

60-DEGREE SURFACE FOR MOST COMMON REAR SIGHT PROFILES

MASTER SIGHT PUSHER*

The Master Sight Pusher is a professional-grade tool that makes quick work of changing pistol sights while protecting both gun slides and the sights themselves. Heavy-duty, built to last and smartly designed to work on most modern pistol sights. The press block features multiple contact surfaces for almost all size and style of press-fit dovetail slots and sight profiles. Adjustable polymer contact surfaces securely hold both 1911 and flat bottom pistol slide styles.

ITEM # AVMSP | MSRP \$149.99

EASILY AND SAFELY CHANGE PRESS-FIT SIGHTS ON GLOCKS.

4MM PRESS BLOCK TOOTH CONNECTS WITHIN THE SIGHT'S DOVETAIL SLOT



SLIDE LOCKING BASE FITS SUBCOMPACT, COMPACT, STANDARD AND COMPETITION GLOCK SLIDES

SIGHT PUSHER FOR GLOCK*

The Sight Pusher for Glock is a professional-grade tool that makes quick work of changing Glock pistol sights while protecting both gun slides and the sights themselves. Heavy-duty, built to last and smartly designed to work on all Glock models, factory and aftermarket Glock sights. The oversized ergonomic Easy Torque™ Handle partners with extra-fine drive threads to provide maximum force with minimal effort when removing and installing Glock sights. A specially-designed press block features multiple contact surfaces to accommodate all Glock sights while applying maximum force to the actual dovetail surface at the optimal leverage point. The slide locking base securely anchors all sizes of Glock slides into place.

ITEM # AVGLOCKSP | MSRP \$99.99

**DISCLAIMER: This product is not manufactured, authorized, endorsed, or warranted by ArmaLite, Inc. ArmaLite, Inc. does not warrant or represent that this product is compatible with AR-10. *AR-10" is a federally registered trademark of ArmaLite, Inc. New Revo Brand Group, LLC, d/b/a Real Avid is not affiliated in any manner with, or otherwise endorsed by ArmaLite, Inc.

*DISCLAIMER: This product is not manufactured, authorized, endorsed, or warranted by GLOCK. GLOCK does not warrant or represent that this product is compatible with GLOCK pistols. "GLOCK" is a federally registered trademark of GLOCK, Inc. and is one of many trademarks owned by GLOCK, Inc. and GLOCK Ges.m.b.H. New Revo Brand Group, LLC, d/b/a Real Avid is not affiliated in any manner with, or otherwise endorsed by, GLOCK, Inc. or GLOCK Ges.m.b.H.



NO MORE COMPROMISES.

HIGH-PERFORMANCE GUN CLEANING™

Leave outdated cleaning kits behind and embrace the next-level performance in firearm maintenance. Our commitment to excellence drives us to continuously improve the gun cleaning experience. Real Avid obsessively crafts top-performing kits, tools and chemicals, setting a new standard in the industry. Clean guns easier and faster.



NEW

GO ANYWHERE. CLEAN ANYWHERE.

180 LUMEN WORK LIGHT WITH 3 SELECTABLE SETTINGS TO ILLUMINATE DARK, HARD-TO-SEE AREAS.

MOBILE WORKSTATION

GUN GRIPPER™
FORM-FITTING RETENTION FOR A TIGHT GRIP

Mobile Workstation with Gun Gripper technology incorporated into the yokes wrap around different contoured barrels and handguards for easy one-handed securement.

FOUR CORNER SMART-DOCKS

SMART ASSIST

QUICK-CONNECT CLIP

EQUIPPED WITH SPECIALIZED TOOLS TO PROFESSIONALLY CLEAN & MAINTAIN YOUR FIREARMS.

HIGH-PERFORMANCE, ALL-IN-ONE, GUN CLEANING KIT IN A MOBILE WORKSTATION.

RIFLE

.22 / .223 CAL / 5.56MM
.243 CAL / 6MM, .260 CAL / 6.5MM
.270 CAL, .284 CAL / 7MM
.30 CAL / 7.62MM

HANDGUN

.22 CAL, .380 CAL / 9MM
.40 CAL, .45 CAL

SHOTGUN

20 GA, 12 GA

BORE-MAX® MASTER CLEANING KIT

MOBILE WORKSTATION FOR GUNS INCLUDES GUN GRIPPER™ YOKES AND SMART-ASSIST™ LIGHTING

BORE-MAX® MASTER CLEANING KIT AND MOBILE WORKSTATION

The Bore-Max Master Cleaning Kit and Mobile Workstation combines the most comprehensive set of high performance cleaning tools with an integrated stand that allows you to clean your guns better and faster anywhere. First-of-its-kind spring-loaded Smart-Fit® Bore-Guide™ offers a deep and consistent seal of the chamber. The Bore-Max Speed Clean System™ cleans bores up to 4x faster and pairs with our new Bore-Max 3-Piece Speed Rod with ultra-glide bearing. Also includes Accu-Grip™ Steel Picks, Smart Brush® Cleaning Brushes and a cleaning mat. This kit provides the most effective way to clean any firearm. All housed in the innovative Mobile Workstation. The workstation is designed to let you clean your gun anywhere. The built-in yokes firmly grip barrels, handguards and stocks. And the four Smart-Assist docks allow you to add a work light (included), magnifying glass or cell phone holder.

NEW ITEM # AVBMMK | MSRP \$199.99

STACKABLE NESTING
Your workspace is valuable and the Bore-Max Master Cleaning Kit and Mobile Workstation helps to maximize this. The base, components tray and lid can be stacked in a variety of ways to free up space during deployment and still access what you need.

- MOBILE WORKSTATION WITH GUN GRIPPER YOKES
- BORE-MAX® BRUSHES™
- BORE-MAX SPEED JAGS™
- BORE-MAX SPEED JAG PATCHES™
- BORE-MAX 3-PIECE SMART ROD – 42"
- SMART-FIT BORE GUIDE
- ACCU-GRIP STEEL PICKS
- SMART BRUSH CLEANING BRUSHES
- GUN & PARTS CLEANING MAT
- SMART-ASSIST™ WORK LIGHT
- INTEGRATED SMART DOCKS

COMPATIBLE WITH **SMART ASSIST** ACCESSORIES



(5-INCH MAGNIFYING GLASS AND CELL PHONE HOLDER NOT INCLUDED - SOLD SEPARATELY)

THE FIRST EVER TRUE GUN WORKSTATION.

REVOLUTIONIZE HOW YOU CLEAN, REPAIR, CUSTOMIZE & MOUNT.

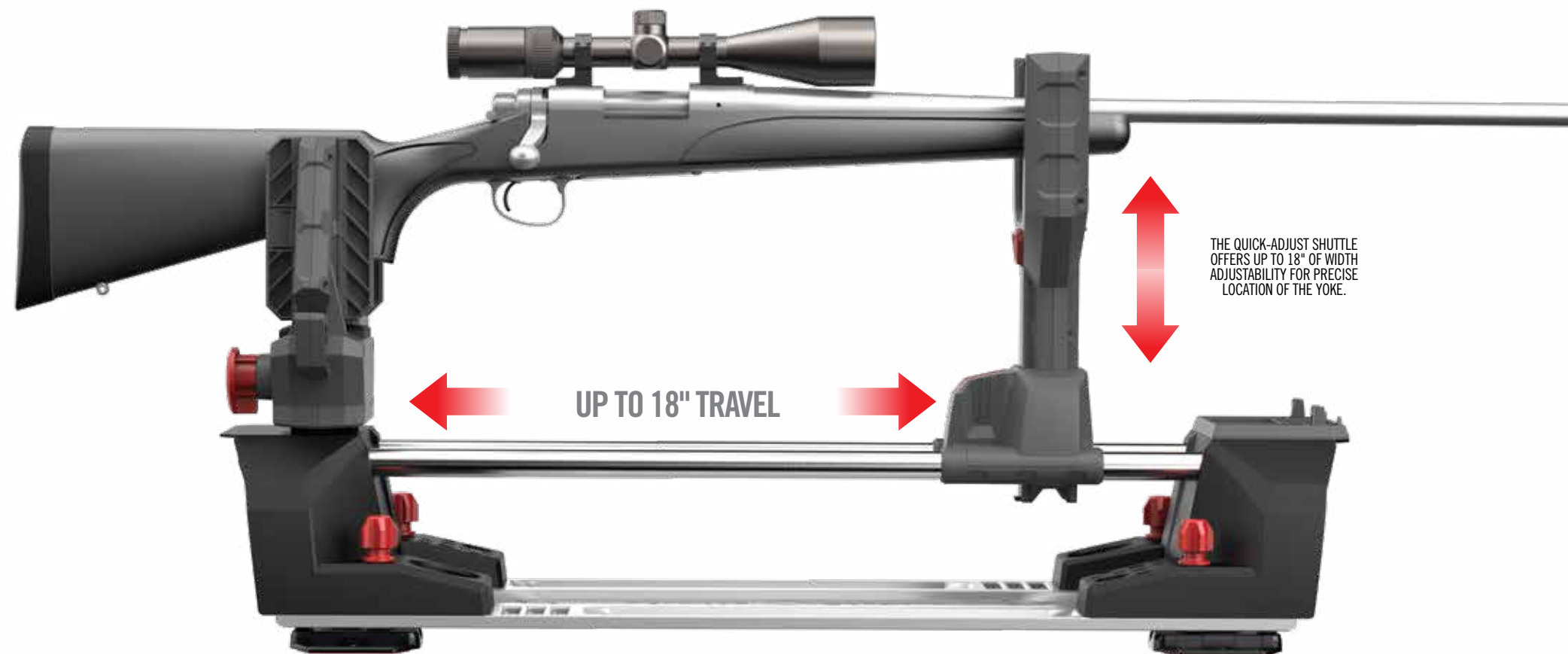

THE QUICK-ADJUST SHUTTLE OFFERS UP TO 18" OF WIDTH ADJUSTABILITY FOR PRECISE LOCATION OF THE YOKE.

UP TO 18" TRAVEL

THE PERFECT FIT FOR YOUR RIFLES AND SHOTGUNS.

GUN GRIPPER™
FORM-FITTING RETENTION FOR TIGHT GRIP ON GUN BARRELS



New Gun Gripper technology incorporated into the yoke wraps around different contoured barrels and handguards providing easy one-handed securement.

MASTER GUN WORKSTATION®

The Master Gun Workstation is the most advanced, versatile and comprehensive firearm workstation available! Cleaning, scope mounting and light gunsmithing have never had it this easy. The ingenious one-handed setup for firearms with chemical, brushes, jags and cleaning rod storage turned what some would call the ultimate vise into the ultimate workstation.

NEW ITEM # AVMGWS | MSRP \$199.99

THE SMART AND EASY WAY TO WORK ON YOUR GUN.



PATENT
realavid.com/pat



TRIGGER CLAMP QUICKLY ENGAGES AND DISENGAGES FORM-FITTING FOAM PADS WITH EASE, TO SECURE YOUR FIREARM FOR THE UTMOST PROTECTION.



WHEN INSTALLING OPTICS, THE ACCU-LEVEL™ KNOB LOCATED ON THE TRIGGER CLAMP OFFERS 6 DEGREES OF TILTING MICRO-ADJUSTMENTS FOR LEVELING FIREARMS.



HEIGHT-ADJUSTABLE, NON-SLIP FEET THAT ARE CAPABLE OF BEING CLAMPED TO A BENCH OR BOLTED DOWN FOR A LONG-TERM SOLUTION.

COMPATIBLE WITH
SMART ASSIST
ACCESSORIES



180 LUMEN WORK LIGHT | 5-INCH MAGNIFYING GLASS | CELL PHONE HOLDER

(ACCESSORIES NOT INCLUDED - SOLD SEPARATELY)

CLEAN GUNS FASTER. PROTECT GUNS LONGER.

ADVANCED TRIPLE-ACTION PERFORMANCE TRI-MAX CLP®

Tri-Max CLP is a chemically-advanced triple threat to the most common enemies of gun performance – friction, corrosion & gunk. Advanced anti-friction additives bond to metal surfaces for longer lasting lubrication of moving gun parts, also creating a protective barrier against gunk, grime and burnt powder for easier cleaning of the action.

EXTREME CORROSION PROTECTION & LUBRICATION GUN-MAX® GUN OIL

Gun-Max's advanced gun-metal grade formula sets a new standard for protecting, lubricating and cleaning modern guns. Maximizes performance of semi-auto guns with high cycle rates. Formulated to excel in sub-zero temperatures and harsh operating conditions.

POWERFUL COPPER & CARBON ELIMINATOR BORE-MAX® BORE FOAM AND SOLVENT

Powerful gun-metal grade solvent is specially formulated to expand and penetrate within the gun bore, rapidly and effectively dissolving performance inhibiting copper and powder fouling.

WICKED FAST GUN ACTION CLEANER & DEGREASER FOUL-OUT® GUNK BLASTER

Foul-Out Gunk Blaster blows away grease and grime fast and leaves no sticky residue. Quickly cleans chambers, actions, trigger groups, bolt groups, slides, choke tube threading, semi-auto gas ports, extractors, ejectors and other hard-to-reach areas.



GUN-MAX GUN OIL 12 OZ AEROSOL	ITEM # AVMLP12A	MSRP \$15.99
GUN-MAX GUN OIL 4 OZ BOTTLE	ITEM # AVBMG04L	MSRP \$9.99
NEW GUN-MAX GUN OIL 1 OZ BOTTLE	ITEM # AVBMG01L	MSRP \$8.99
GUN-MAX WIPES SINGLES 25 PACK	ITEM # AVGMW25	MSRP \$16.99
TRI-MAX CLP 12 OZ AEROSOL	ITEM # AVCLP12A	MSRP \$15.99
TRI-MAX CLP 4 OZ BOTTLE	ITEM # AVCLP4L	MSRP \$9.99
TRI-MAX CLP 60 COUNT CANISTER	ITEM # AVCLPW-C60	MSRP \$16.99
BORE-MAX BORE FOAM 12 OZ AEROSOL	ITEM # AVFBC12A	MSRP \$15.99
BORE-MAX BORE SOLVENT 4 OZ BOTTLE	ITEM # AVBMS4L	MSRP \$9.99
FOUL-OUT GUNK BLASTER 12 OZ AEROSOL	ITEM # AVDCB12A	MSRP \$15.99

TWO-POSITION NOZZLE STRAW

AN INDUSTRY-FIRST FLIP-UP NOZZLE PROVIDES PIN-POINT CHEMICAL APPLICATION WITH NOZZLE IN THE "UP" POSITION. THE "DOWN" POSITION PROVIDES A WIDER SPRAY AND SAFELY STORES THE STRAW WHEN NOT IN USE.



THE BORE-MAX® SPEED CLEAN SYSTEM™ IS PRECISELY SIZED FOR MAXIMUM BORE CONTACT.

The Bore-Max Speed Jag™ & Patches Multi-Cal Pack and Bore-Max Speed Brush® Multi-Cal Pack includes 10 popular pistol and rifle calibers in one convenient storage case.

INCLUDES SET OF 10 JAGS:

- RIFLE**
.22 / .223 CAL / 5.56MM
.243 CAL / 6MM
.260 CAL / 6.5MM
.270 CAL, .284 CAL / 7MM
.30 CAL / 7.62MM

- HANDGUN**
.22 CAL, .380 CAL / 9MM
.40 CAL, .45 CAL

INCLUDES
500
SPEED PATCHES



NEW BORE-MAX SPEED JAG & PATCHES MULTI-CAL PACK
NEW BORE-MAX SPEED BRUSH MULTI-CAL PACK

INCLUDES SET OF 10 BRUSHES:

- RIFLE**
.22 / .223 CAL / 5.56MM
.243 CAL / 6MM
.260 CAL / 6.5MM
.270 CAL, .284 CAL / 7MM
.30 CAL / 7.62MM

- HANDGUN**
.22 CAL, .380 CAL / 9MM
.40 CAL, .45 CAL



ITEM # AVBMJAGS
ITEM # AVBMSBS

MSRP \$49.99
MSRP \$39.99

REVOLUTIONARY BORE CLEANING SYSTEM.



Maximizing bore contact yields better results. Bore cleaning is a chore, and so the goal is simple – get it done faster and get it done right. The Bore-Max Speed Clean System delivers up to 4 times more bore cleaning contact per pass than traditional brushes, jags and patches. This means less passes to clean your bore and less time spent on the chore. Upgrade to High Performance Gun Care!

BORE-MAX SPEED BRUSHES™

Twice the bristle density of standard brushes for maximum scrubbing power. Stiff, nickel-plated phosphor bronze bristles eliminate chemical breakdown in the bore and extend the life of the brush.

BORE-MAX SPEED JAGS™ & PATCHES

Speed Jag and Speed Jag Patches are sized exactly to work in tandem delivering precise bore fitment by caliber, resulting in the removal of up to 4 times the copper and carbon of shorter traditional jags and square patches. This means a cleaner bore with less pass throughs.

BORE-MAX SPEED CLEAN SYSTEM INCLUDES SPEED BRUSH, JAG AND PATCHES

An all-in-one upgrade system for faster and easier bore cleaning. System includes the Bore-Max Speed Brush with twice the bristle density of traditional brushes, making it twice as effective in agitating the surface in preparation for the jag and patch. Finish off with the Speed Jag and Patch combination to remove up to 4 times the carbon and copper of shorter traditional jags and square patches.

BORE-MAX SPEED JAG PATCHES™ REFILL

Speed Jag Patches are specifically designed to provide no-bunch scrubbing when used with corresponding caliber specific Speed Jags. The micro-pore fibers provide maximum absorbency and grit-grabbing surface texture without fraying or dropping lint.

BORE-MAX SPEED BRUSHES

.22 / .223 CAL / 5.56MM	ITEM # AVBMSB223	MSRP \$4.99
.243 CAL / 6MM	ITEM # AVBMSB243	MSRP \$4.99
.260 CAL / 6.5MM	ITEM # AVBMSB65MM	MSRP \$4.99
.270 CAL	ITEM # AVBMSB270	MSRP \$4.99
.284 CAL / 7MM	ITEM # AVBMSB7MM	MSRP \$4.99
.30 CAL / 7.62MM	ITEM # AVBMSB30	MSRP \$4.99
.338 CAL	ITEM # AVBMSB338	MSRP \$4.99
.35 CAL	ITEM # AVBMSB35	MSRP \$4.99
.375 CAL	ITEM # AVBMSB375	MSRP \$4.99
.22 CAL	ITEM # AVBMSB22	MSRP \$4.99
.380 CAL / 9MM	ITEM # AVBMSB9MM	MSRP \$4.99
.40 CAL	ITEM # AVBMSB40	MSRP \$4.99
.45 CAL	ITEM # AVBMSB45	MSRP \$4.99
12 GA	ITEM # AVBMSB12G	MSRP \$4.99
20 GA	ITEM # AVBMSB20G	MSRP \$4.99

BORE-MAX SPEED JAG & PATCHES

.22 / .223 CAL / 5.56MM	ITEM # AVBMJAG223	MSRP \$5.99
.243 CAL / 6MM	ITEM # AVBMJAG243	MSRP \$5.99
.260 CAL / 6.5MM	ITEM # AVBMJAG65MM	MSRP \$5.99
.270 CAL	ITEM # AVBMJAG270	MSRP \$5.99
.284 CAL / 7MM	ITEM # AVBMJAG7MM	MSRP \$5.99
.30 CAL / 7.62MM	ITEM # AVBMJAG30	MSRP \$5.99
.22 CAL	ITEM # AVBMJAG22	MSRP \$5.99
.380 CAL / 9MM	ITEM # AVBMJAG9MM	MSRP \$5.99
.40 CAL	ITEM # AVBMJAG40	MSRP \$5.99
.45 CAL	ITEM # AVBMJAG45	MSRP \$5.99

BORE-MAX SPEED CLEAN SYSTEM

INCLUDES SPEED BRUSH, JAG AND PATCHES

.22 / .223 CAL / 5.56MM	ITEM # AVBMSET223	MSRP \$9.99
.243 CAL / 6MM	ITEM # AVBMSET243	MSRP \$9.99
.260 CAL / 6.5MM	ITEM # AVBMSET65MM	MSRP \$9.99
.270 CAL	ITEM # AVBMSET270	MSRP \$9.99
.30 CAL / 7.62MM	ITEM # AVBMSET30	MSRP \$9.99
.380 CAL / 9MM	ITEM # AVBMSET9MM	MSRP \$9.99
.40 CAL	ITEM # AVBMSET40	MSRP \$9.99
.45 CAL	ITEM # AVBMSET45	MSRP \$9.99

BORE-MAX SPEED JAG PATCHES REFILL

RIFLE	ITEM # AVBMPATCH8	MSRP \$8.99
HANDGUN .32 - .45 CAL	ITEM # AVBMPATCH4L	MSRP \$8.99
HANDGUN .22 CAL	ITEM # AVBMPATCH4S	MSRP \$8.99

MAXIMUM BORE CLEANING.

THE PORTABLE, SECURE GUN CLEANING AND MODIFICATION STAND.



ADJUSTABLE 10" – 16" FOOTPRINT

GUN GRIPPER™ TECHNOLOGY.

Flexible support allows for the right amount of friction and retention when working on your firearms.



GUN GRIPPER™
FORM-FITTING RETENTION FOR FIREARMS.

THE PORTABLE, SECURE GUN CLEANING AND MODIFICATION STAND.

PATENT
realavid.com/pat

SPEED STAND™

The Speed Stand is the most portable and convenient gun cleaning stand on the market. Use at home or at the range for quick modifications and cleaning on all your rifles and shotguns. The adjustable feet allow for use on uneven surfaces while the Gun Gripper yokes firmly secure your firearm.

ITEM # AVSSFG | MSRP \$49.99

NEW

SPRING-LOADED DESIGN ALLOWS FOR A CONSISTENT CHAMBER SEALING.

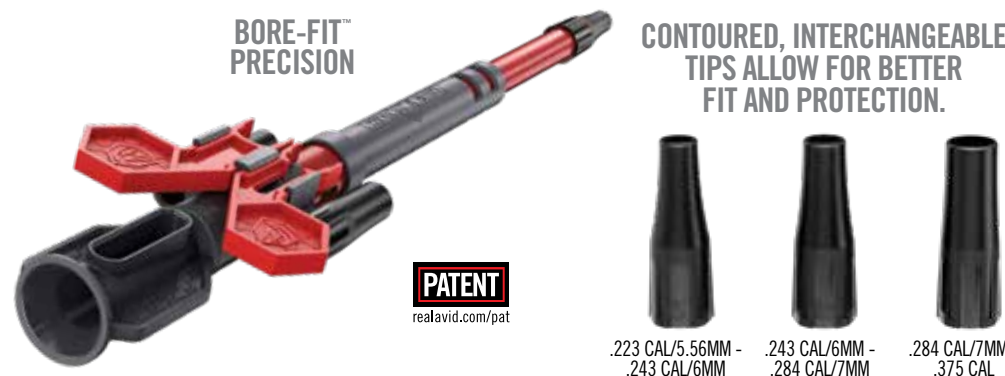

BORE-FIT™ PRECISION

PATENT
realavid.com/pat

CONTOURED, INTERCHANGEABLE TIPS ALLOW FOR BETTER FIT AND PROTECTION.



SMART-FIT® BORE GUIDE™

The Smart-Fit Bore Guide is the ultimate and first-of-its-kind spring-loaded, precision cleaning tool, providing worry-free cleaning. The spring-loaded slider locks, providing a secure fitment and ensures a consistent chamber sealing with zero movement when running brushes and patches through your bore. An anodized aluminum tube is designed for lasting durability and the contoured, non-marring, bore-specific tips ensure damage-free, precise fitment on centerfire rifles from .223 - .375 caliber.

NEW ITEM # AVBMBG | MSRP \$24.99

ULTRA-GLIDE BEARINGS DELIVER SILKY-SMOOTH ROTATION TO EFFECTIVELY CLEAN LANDS & GROOVES.

PATENT
realavid.com/pat



BORE-MAX® SMART ROD®

Upgraded comfort grip made for pushing and pulling jags, patches and brushes through the bore. Easier on your wrist and hands due to the vertical grip versus old-school horizontal screwdriver grips. The carbon fiber rod easily turns through the bore following the rifling thanks to the ultra-glide bearing handle attachment.

.22 - .270 CAL 36" CARBON FIBER
.270 - .45 CAL 36" CARBON FIBER
.270 - .45 CAL 44" CARBON FIBER
.22 - .45 CAL 9" CARBON FIBER

ITEM # AVBMSR2236
ITEM # AVBMSR3036
ITEM # AVBMSR3044
ITEM # AVBMSR2209

MSRP \$39.99
MSRP \$39.99
MSRP \$44.99
MSRP \$34.99

THE ULTIMATE WAY TO CLEAN AND MAINTAIN AR15s.

BOLT CARRIER GROUP CARBON REMOVAL MULTI-TOOL

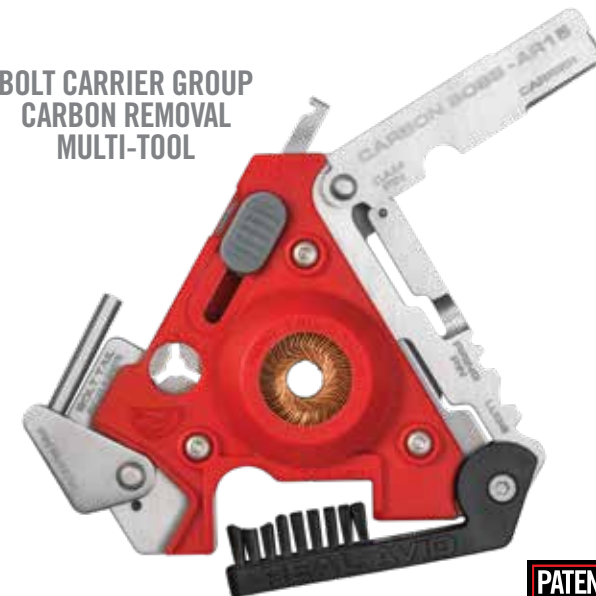

PATENT
realavid.com/pat

NEXT-GEN CARBON SUPER TOOL FOR BCG'S



BALLISTIC NYLON SHEATH

CARBON BOSS® - AR15

Smartly designed, this is the most comprehensive carbon removal multi-tool ever. Packed with easy-to-use precision cleaning tools.

ITEM # AVCARBAR15 | MSRP \$34.99



PRECISION CLEANING TOOL FOR BCG'S

THE AR15 SCRAPER™

A dirty bolt carrier group (BCG) is the #1 cause of AR15 malfunctions. Carbon is the enemy and it quickly builds up in hard-to-clean areas.

ITEM # AVAR15S | MSRP \$19.99



ALL-IN-1 CHAMBER CLEANING KIT

CHAMBER BOSS® - AR15

Every tool you need to easily eliminate baked-on carbon from the AR15 chamber. All cleaning implements store inside the ergonomic handle.

ITEM # AVAR15CB | MSRP \$29.99



ALL COMPONENTS WORK WITH STANDARD 8-32 THREADS

.223 CAL / 5.56MM CHAMBER AND BORE CLEANING.

AR15 BRUSH COMBO™

The AR15 Brush Combo contains the critical components you need to keep your AR15 chamber and bore carbon free.

ITEM # AVAR15BC | MSRP \$9.99

AR15 STAR CHAMBER CLEANING PADS

Use a star chamber brush to loosen the carbon then remove it with our star chamber cleaning pads (20 count pack) and a healthy dose of solvent.

ITEM # AVAR15CP | MSRP \$12.99

AR15 PIVOT LOCK
STAR CHAMBER BRUSH
5 WOOL STAR CHAMBER CLEANING PADS
SCRAPER PRECISELY FITS BARREL EXTENSION AND INTERNAL CHAMBER

PREMIUM .223 CAL / 5.56MM STAR CHAMBER CLEANING PADS



FIRST-EVER SELF-STORING, ALL-IN-ONE GUN CLEANING STATIONS.

ADVANCED CLEANING KIT,
DELUXE GUN MAT, ALL-IN-ONE.

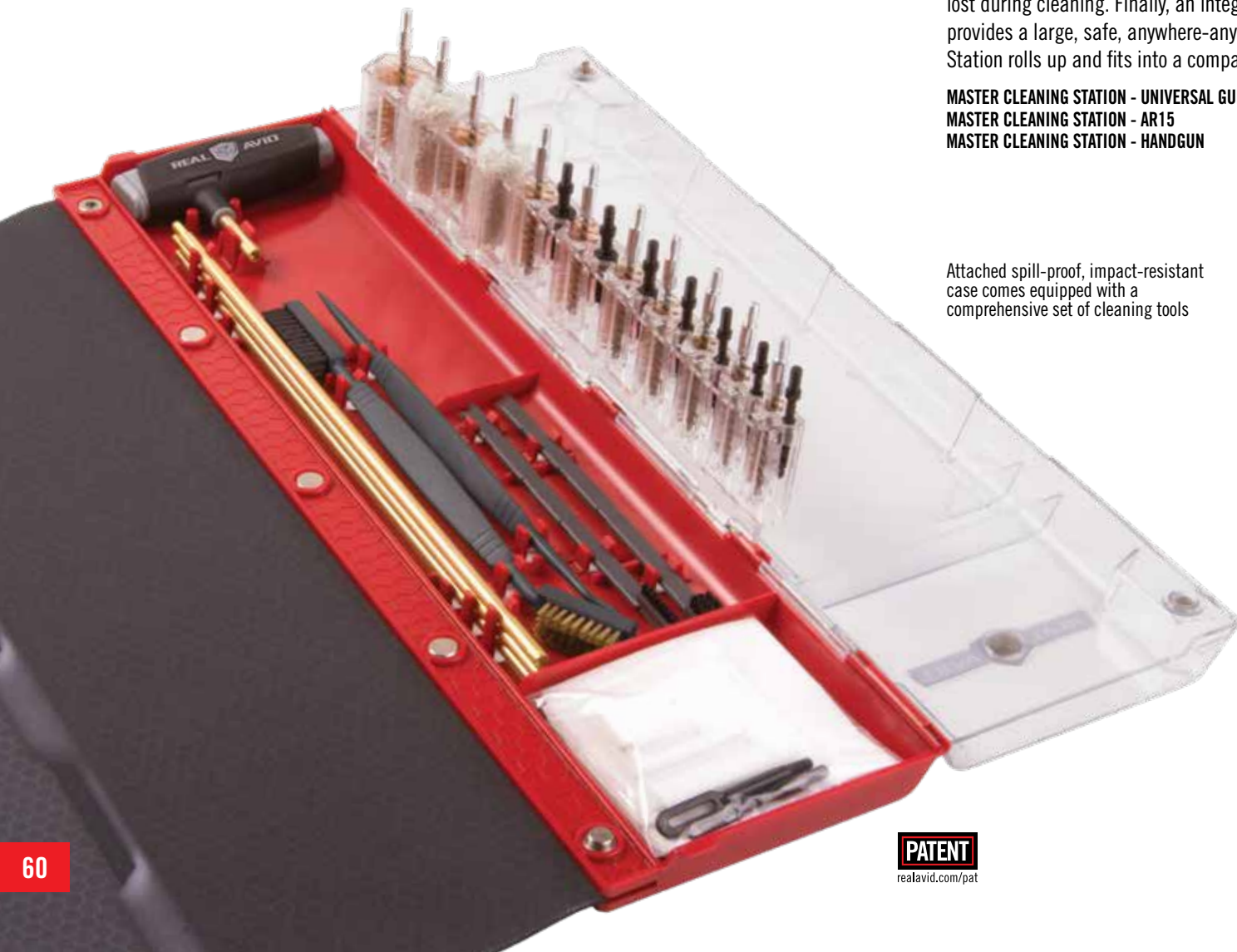

MASTER CLEANING STATION®

The world's first Master Cleaning Stations. Designed to empower gun owners to thoroughly clean guns from bore, breech and action down to the component level. The case provides frustration-free, spill-proof storage and features a proprietary pop-up storage riser making every tool easy to extract and return to its fitted holder. A magnetic parts tray keeps small gun parts from getting lost during cleaning. Finally, an integrated, oil-resistant, non-slip backed, padded cleaning mat provides a large, safe, anywhere-anytime cleaning surface. The entire expansive Master Cleaning Station rolls up and fits into a compact storage bag.

MASTER CLEANING STATION - UNIVERSAL GUN	ITEM # AVMCS-U	MSRP \$59.99
MASTER CLEANING STATION - AR15	ITEM # AVMCS-AR	MSRP \$69.99
MASTER CLEANING STATION - HANDGUN	ITEM # AVMCS-P	MSRP \$49.99

Attached spill-proof, impact-resistant case comes equipped with a comprehensive set of cleaning tools



UNIVERSAL GUN



AR15



HANDGUN



ERGONOMIC HANDLE ROTATES, TAPS PINS AND ALSO WORKS AS A DETAILING HANDLE

PROFESSIONAL-GRADE KITS. NOT TYPICAL, CHEAP, TRAY-BASED, SPILL-PRONE KITS.

ALL THE COMPONENTS TO
CLEAN ALL YOUR GUNS

GUN BOSS® PRO

Gun Boss Pro is the answer to cheap, flimsy, spill-prone cleaning kits. The virtually indestructible, stand-up case puts a complete set of gun cleaning tools at your fingertips. Premium components are secured into labeled, fitted tool slots and stay organized. No annoying loose parts. Conveniently the lid doubles as a kick-stand, standing the case up for easy access to tools.

GUN BOSS PRO - UNIVERSAL CLEANING KIT	ITEM # AVGBPRO-U	MSRP \$34.99
GUN BOSS PRO - AR15 CLEANING KIT	ITEM # AVGBPROAR15	MSRP \$29.99
GUN BOSS PRO - HANDGUN CLEANING KIT	ITEM # AVGBPRO-P	MSRP \$24.99
GUN BOSS PRO - PRECISION CLEANING TOOLS	ITEM # AVGBPROPCT	MSRP \$19.99



UNIVERSAL



AR15



HANDGUN



PRECISION



ERGONOMIC HANDLE ROTATES, TAPS PINS AND ALSO WORKS AS A DETAILING HANDLE

MULTI-FUNCTION T-HANDLE

STAND-UP CASE

CRUSH-PROOF, SPILL-PROOF CASE FLIPS OPEN AND STANDS UP FOR ORGANIZED, EASY ACCESS.

HOME & FIELD DOUBLE-DUTY, PROFESSIONAL GUN CLEANING KITS.

GUN BOSS® MULTI-KIT

Home and field double-duty, single-caliber, specialized gun cleaning kits. Kits include the Bore Boss® for a quick clean any time you shoot your gun, and an expanded gun cleaning kit with all the tools you need to fully clean the bore, action and chamber.

.22 CAL	RIFLE	ITEM # AVGBMK22	MSRP \$29.99
.223 CAL / 5.56MM	RIFLE	ITEM # AVGBMK223	MSRP \$34.99
.243 / .260 CAL / 6.5MM	RIFLE	ITEM # AVGBMK243	MSRP \$29.99
.270 / .280 CAL / 7MM	RIFLE	ITEM # AVGBMK270	MSRP \$29.99
.30 / .308 CAL / 7.62MM	RIFLE	ITEM # AVGBMK308	MSRP \$29.99
.357 / .38 CAL / 9MM	HANDGUN	ITEM # AVGBMK9MM	MSRP \$29.99

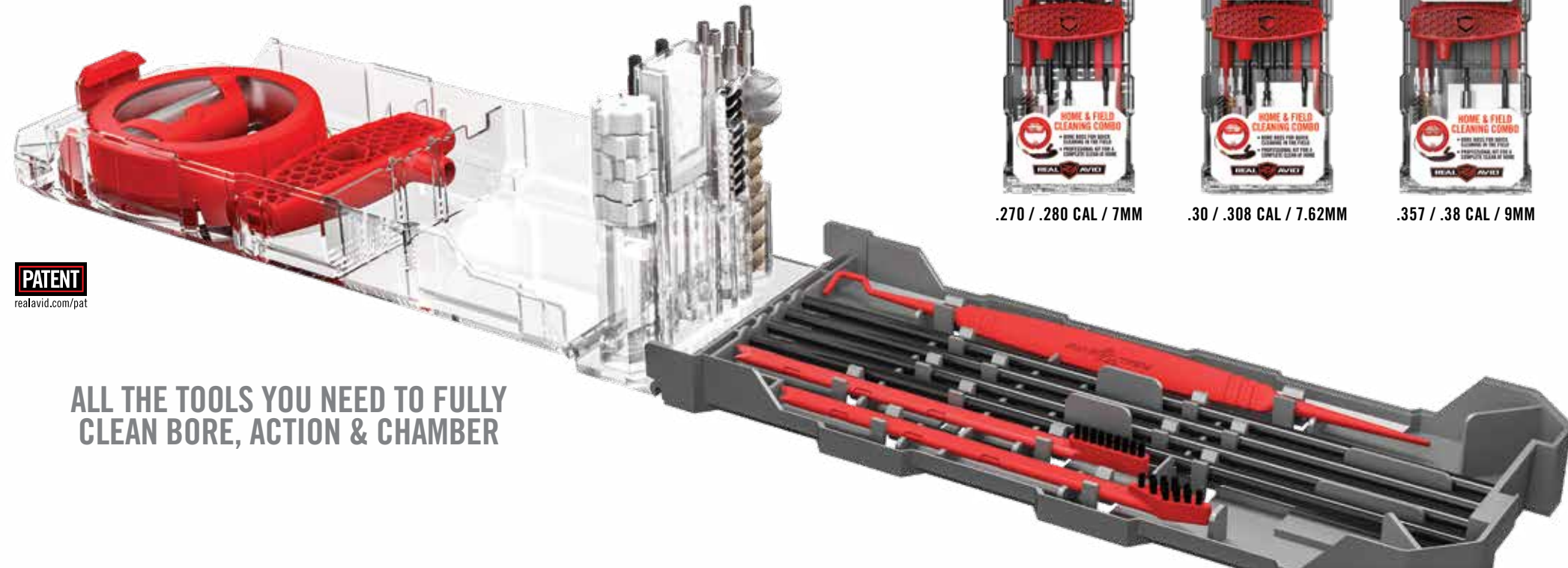

SMART, ORGANIZED & FULLY EQUIPPED TO CLEAN ON THE BENCH OR IN THE FIELD.



.22 CAL .223 CAL / 5.56MM .243 / .260 CAL / 6.5MM



.270 / .280 CAL / 7MM .30 / .308 CAL / 7.62MM .357 / .38 CAL / 9MM

WORLD'S EASIEST BORE CLEANER IS NOW THE FASTEST SELLER.



PATENT
realavid.com/pat

12 CHOICES - .17 CAL TO 12 GA

BORE BOSS®

The single-piece Dual-Action Cable with integrated phosphor bronze brush and braided mop wraps around the unique Flex-Case Handle to keep the system stowed and organized. To use, simply flip, feed, clip and pull. Throw it in your pack, or put it in your pocket. It's the next best thing to a self-cleaning gun.

.17 CAL	RIFLE	ITEM # AVBB17	MSRP \$9.99
.22 CAL	RIFLE	ITEM # AVBB22	MSRP \$9.99
.223 CAL / 5.56MM	RIFLE	ITEM # AVBB223	MSRP \$9.99
.243 / .260 CAL / 6.5MM	RIFLE	ITEM # AVBB243	MSRP \$9.99
.270 / .280 CAL / 7MM	RIFLE	ITEM # AVBB270	MSRP \$9.99
.30 / .308 CAL / 7.62MM	RIFLE	ITEM # AVBB308	MSRP \$9.99
9MM CARBINE	CARBINE	ITEM # AVBB9MM-CAR	MSRP \$9.99
.357 / .38 CAL / 9MM	HANDGUN	ITEM # AVBB9MM	MSRP \$9.99
.40 / .41 CAL	HANDGUN	ITEM # AVBB40	MSRP \$9.99
.44 / .45 CAL	HANDGUN	ITEM # AVBB45	MSRP \$9.99
20 GA	SHOTGUN	ITEM # AVBB20G	MSRP \$9.99
12 GA (NEW LONGER SIZE)	SHOTGUN	ITEM # AVBB12G	MSRP \$9.99

RUGGED & READY TACTICAL CLEANING KITS.

AR15 KIT FITS
.223 CAL / 5.56MM

20-PIECE AR15
CLEANING KIT

GUN BOSS® - AR15

Extremely compact so it can be carried anywhere. It contains everything needed to preserve the accuracy and reliability of an AR15. A chamber brush, carbon picks and star chamber pads help to clean more than the bore and keep your bolt cycling smoothly. Smartly organized, each brush, pick, jag, patch, pad and rod is held securely in place.

ITEM # AVGCKAR15 | MSRP \$29.99



14-PIECE SHOTGUN
CLEANING KIT

SHOTGUN KIT FITS
20 & 12 GA

GUN BOSS® - SHOTGUN

Big functionality in a small rugged package that easily fits into a pack or range bag. A complete cleaning kit designed to keep your shotgun tip-top in the field. No annoying loose parts. Smartly organized, each brush, mop and slotted patch tip is held securely in place. The Gun Boss Shotgun Cleaning Kit is a complete cleaning system that easily travels with you.

ITEM # AVGCK310-S | MSRP \$19.99



HANDGUN KIT FITS
.22 - .45 CAL

13-PIECE HANDGUN
CLEANING KIT

GUN BOSS® - HANDGUN

A complete system to keep your handgun clean and firing accurately. Aluminum connectors, nylon jags, slotted tips and phosphor bronze brushes protect bores. Take it anywhere, exclusively for handguns the Gun Boss Handgun Cleaning Kit moves easily between the field, range and workbench.

ITEM # AVGCK310-P | MSRP \$19.99



MAGNETIC BORE LIGHT™

HANDS-FREE
ILLUMINATION

Magnetic bore light clings to your firearm's steel surfaces for quick and easy inspection into your bore, chamber or action.

ITEM # AVBR101-B | MSRP \$9.99



PATENT
realavid.com/pat

ALL THE TOOLS YOU NEED TO FULLY CLEAN BORE, ACTION & CHAMBER



LONG GUN MATS 43" X 16"
HANDGUN MATS 19" X 16"

NEXT-GEN CLEANING MATS WITH INTEGRATED PARTS TRAY.

SMART MAT® CLEANING MATS

These are cleaning mats on steroids. The no-slip backed padded mat features an oil-resistant surface, allowing you to properly clean your gun without ruining the kitchen table and is large enough to handle field-stripped guns. The ingenious magnetic parts tray ensures your pins, screws and springs are never lost again.

SMART MAT - AR15	ITEM # AVAR15SM	MSRP \$24.99
SMART MAT - UNIVERSAL	ITEM # AVULGSM	MSRP \$24.99
SMART MAT - GLOCK*	ITEM # AVGLOCKSM	MSRP \$19.99
SMART MAT - HANDGUN	ITEM # AVUHGSM	MSRP \$19.99

PATENT
realavid.com/pat

TABLE GRIPPING, OIL REPELLING, SHOCK ABSORBING, PARTS SECURING, GUN CLEANING AWESOMENESS.

AR15



UNIVERSAL



GLOCK



HANDGUN



ERGONOMOMIC GUN DETAILING TOOLS.



INNOVATIVE, ERGONOMOMIC TRIANGULAR HANDLES

CLEAN THE CARBON OUT OF YOUR FIREARMS.

ACCU-GRIP™ STEEL PICKS

Firearm owners have had no choice but to use subpar cleaning picks for years. Accu-Grip Steel Picks offer specifically designed tips ensuring easy work on carbon build-up. The ergonomic design and stainless steel picks fit comfortably in your hand and offer superior control when cleaning hard-to-reach areas. Great for general firearm maintenance where plastic picks and cleaning solvents aren't enough. Throw away those toothpicks and use tools that were designed for the job.

NEW ITEM # AVAGSPS | MSRP \$39.99



INNOVATIVE, ERGONOMOMIC TRIANGULAR HANDLES

LENGTHS 8" TO 8 1/4"

ERGONOMOMIC GUN DETAILING TOOLS

ACCU-GRIP™ PICKS & BRUSHES

We created a superior line of picks and brushes that gives you complete control when cleaning hard-to-reach areas, comfortably fits in your hand and most importantly – won't damage your firearm.

ITEM # AVPBS | MSRP \$11.99



CARBON BUSTING MICRO-BRISTLES



LENGTH 5 1/2"

8 SUPER-SCRUBBER GUN BRUSHES WITH INTEGRATED SCRAPERS

SMART BRUSH® CLEANING BRUSHES

Our unique brush shapes with integrated scrapers are designed to specifically clean hard-to-reach interior and exterior surfaces where carbon and gunk accumulate.

ITEM # AVSB01 | MSRP \$11.99



*DISCLAIMER: This product is not manufactured, authorized, endorsed, or warranted by GLOCK. GLOCK does not warrant or represent that this product is compatible with GLOCK pistols. "GLOCK" is a federally registered trademark of GLOCK, Inc. and is one of many trademarks owned by GLOCK, Inc. and GLOCK Ges.m.b.H. New Revo Brand Group, LLC, d/b/a Real Avid is not affiliated in any manner with, or otherwise endorsed by, GLOCK, Inc. or GLOCK Ges.m.b.H.



MULTI-TOOLS FOR GUNS. NOT CAMPING.

GUN-SPECIFIC MULTI-TOOLS

These aren't your grandfather's multi-tools. We've redefined the multi-tools category to meet the specific needs of modern guns and their owners. ARs, pistols, rifles, shotguns.

Whatever you shoot, we have the tool you need to stay in the game.

CRITICAL-TASK CARRY TOOLS.



AR15
AR15 ADVANCED
CARRY TOOL



PISTOL
PISTOL PACKING
CAPABILITY

NEW

GUN TOOL EDGE™

Gun Tool Edge redefines firearm maintenance with precision and durability. The AR15 tactical knife/multi-tool features a 2.6" Tanto blade, titanium and black oxide finishes for superior performance. With 12 functions, it excels in the field. The pistol tactical knife/multi-tool ensures readiness with a 2.6" Wharncliffe blade, hex keys, and titanium finishes. Stainless steel components guarantee easy access. Both purpose-driven solutions redefine firearm excellence, offering efficiency and precision in maintenance. Upgrade your gear for a new era of performance and versatility.

NEW GUN TOOL EDGE - AR15
NEW GUN TOOL EDGE - PISTOL

ITEM # AVGTE-AR
ITEM # AVGTE-P

MSRP \$49.99
MSRP \$49.99



SHOTGUN

AR15

CARABINER-LIKE FUNCTION SECURES TO MOLLE STRAPS

GUN TOOL CORE®

Compact and fully capable, the Gun Tool CORE is the ideal tool for performing critical "keep shooting" tasks on your gun. Small and streamlined in stature, but big on solving the most commonly encountered problems, keeping you up and running in the field or at the range. Easy to carry with carabiner-like modularity, CORE easily secures to MOLLE straps or a belt. CORE is a must-have carry tool for serious shooters.

GUN TOOL CORE - SHOTGUN
GUN TOOL CORE - AR15

ITEM # AVGTCOR-SG
ITEM # AVGTCOR-AR

MSRP \$39.99
MSRP \$39.99

PATENT
realavid.com/pat

THE SMARTEST, MOST CAPABLE MULTI-TOOLS FOR THE WORLD'S MOST POPULAR PLATFORM.



PATENT
realavid.com/pat

AR15 TOOL™

This beefy, folding X-frame tool is built specifically for the needs of AR15 owners who want to keep their gun in the fight. It equips users to quickly remove carbon from all 12 critical surfaces of the bolt carrier group, make repairs in the field or on the bench, reduce malfunctions, add or remove accessories, make sight adjustments and easily disassemble and reassemble their guns.

ITEM # AVAR15T | MSRP \$89.99



INCLUDES 9 BITS:

- 3/32" ALLEN®
- 1/8" ALLEN
- 3/16" ALLEN
- 3/32" FLAT
- 7/64" ALLEN
- 9/64" ALLEN
- #1 PHILLIPS®
- 3/16" FLAT
- AR15 PIN PUNCH



MOLLE-COMPATIBLE BALLISTIC NYLON SHEATH



35-IN-1 GUN MULTI-TOOL FOR THE AR15

GUN TOOL PRO® - AR15

When it comes to keeping your AR15 going bang and getting the most for your buck, Gun Tool Pro - AR15 is the clear choice. Thirty-five highly capable tools in a tactical, rugged design work with ease and precision to keep black guns firing reliably and accurately. From teardown and carbon scraping, to maintenance and reassembly.

ITEM # AVGTPROAR | MSRP \$59.99

TOOLS SPECIFICALLY DESIGNED FOR POPULAR RIFLE AND SHOTGUN PLATFORMS.



GUN TOOL MAX®

Packed with precision-made, gun-specific tools for hunters and shooters, this highly-versatile multi-tool repairs, customizes and makes disassembly and reassembly fast and easy. The ballistic nylon sheath carries 12 additional bits for added functionality. It's a whole new breed of Gun Tool.

ITEM # AVGTMAX | MSRP \$79.99

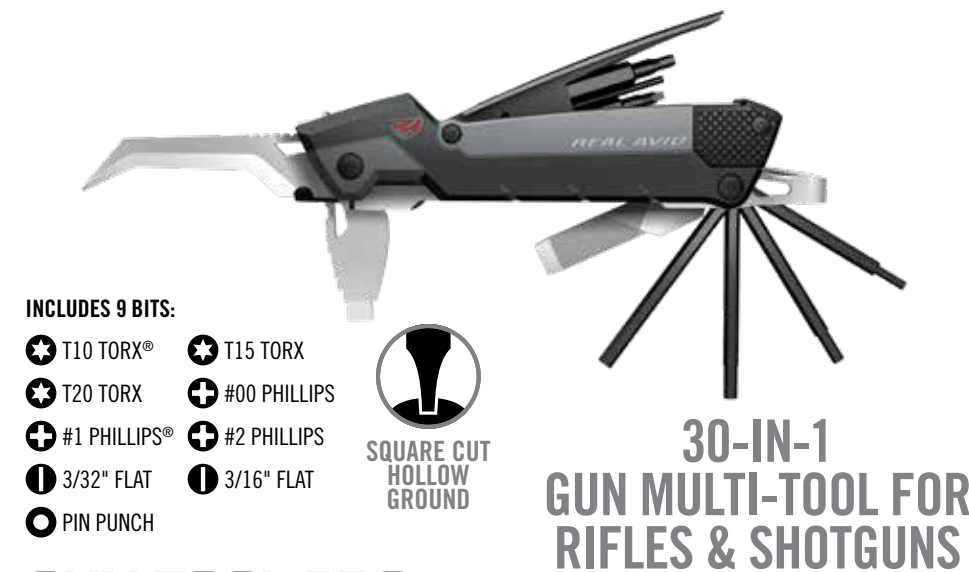

18-IN-1 SHOOTERS MULTI-TOOL

THE GUN TOOL™

The Gun Tool is the original shooter's multi-tool. This patented design features 18 of the most frequently used firearm tools. The Gun Tool gives you a lot of capability whether you're in the field, on the range or at your workbench.

ITEM # AVGTCL211 | MSRP \$29.99

THE HANDGUN OWNERS' TOOL KIT THAT FITS IN A MAG POUCH.

19-IN-1 GUN MULTI-TOOL FOR HANDGUNS



SQUARE CUT HOLLOW GROUND

6 HEX BITS WITH BALL DETENTS:

- ★ T15 TORX®
- ⊖ 1/8" FLAT
- ⊕ #1 PHILLIPS®
- ⊖ 3/32" HEX
- ⊖ 3/16" FLAT
- ⊕ #2 PHILLIPS



COMPACT SIZE FITS CONVENIENTLY INTO A PISTOL MAG POUCH

4 BONDHUS PROTANIUM® HEX KEYS FOR LASER SIGHTS



THE PISTOL TOOL™

The list of possibilities is long and thorough – mounting accessories, field disassembly, adjusting laser sights and changing side grips are just a few. Here, with easy one-hand access, is every tool a shooter could want to service and adjust the handgun of their choosing. Each tool locks open and is carefully calibrated to popular pistol platforms – from a polymer striker fired pistol to everything needed to take down the 1911.

ITEM # AVPSTL | MSRP \$39.99



BARREL BUSHING WRENCH

SMART WRENCH® - 1911

Finally, a solution to the problem you've been dealing with for years. Removing the barrel bushing on your 1911 has never been easier. Press and turn. The ingenious design keeps the spring and plug corralled – and you out of the dentist's chair.

ITEM # AV1911SW | MSRP \$12.99

NEXT LEVEL A1 & A2 FRONT SIGHT ADJUSTMENT



FRONT SIGHT ADJUSTER™ PRO



This smartly-designed tool makes front sight adjustments quick, easy and painless. The new longer, black oxide coated steel shaft is paired with an ingenious T-Handle to create the perfect combo when working with both A1 & A2 front sights. The compact carry case makes storing and protecting your tool easier, whether in your range bag or hanging from a lanyard.

ITEM # AVARFSAPRO | MSRP \$19.99

FITS BOTH 5-PIN AND 4-PIN FRONT SIGHTS



AR15 FRONT SIGHT ADJUSTER TOOL

This smartly-designed tool makes front sight adjustments quick and easy. The stainless steel shaft is knurled to create no-slip leverage when turning tight posts.

ITEM # AVAR15FSA | MSRP \$9.99

18-IN-1 CARRY TOOL

MICRO TOOL™ - AR15

AR15-specific functionality packed into a micro-sized tool. A multitude of breakdown, carbon scraping, adjusting and sighting-in options are ready at a moments notice. This pint-sized tool is as welcome on your keychain as it is at the range. Always be prepared, no matter the scenario.

ITEM # AVMICROAR15 | MSRP \$19.99



THE ONLY CHOKE TUBE WRENCH YOU WILL EVER NEED

FINI™ - UNIVERSAL CHOKE TUBE WRENCH

This pocket-sized tool is the most versatile choke wrench ever. It fits most brands and all gauges between .410 and 10 gauge. It also sports a handy screwdriver blade perfect for adjusting scope turrets or making repairs.

ITEM # AVCWT210 | MSRP \$9.99

ESSENTIAL TOOLS FOR GLOCK® OWNERS.



PUSH BUTTON ARMORER'S MULTI-TOOL

- ⊖ 3/16" HEX NUT DRIVER
- ⊖ .050" ALLEN® WRENCH
- ⊖ FLAT BLADE SCREWDRIVER
- ⊖ 3MM ARMORER'S PIN PUNCH

PUSH BUTTON DEPLOYMENT OF 4 GLOCK-SPECIFIC TOOLS.

4-IN-1 TOOL™ FOR GLOCK®*

Sleek, ergonomic, packed with function. In every way a thoroughly modern armorer's tool for Glock owners. Four different tools store inside the handle and each snaps open and locks in place with the push of a button. Remove pins for disassembly, change out front sights, remove slide lock spring and locking block and adjust aftermarket rear sights.

ITEM # AVGLOCK41 | MSRP \$29.99

ARMORER'S COMBINATION DISASSEMBLY & FRONT SIGHT TOOL



THE GLOCK OWNER'S ESSENTIAL TOOL. FITS ALL MODELS.

- ⊖ 3/16" HEX NUT DRIVER
- ⊖ 3MM ARMORER'S PIN PUNCH

2-IN-1 TOOL™ FOR GLOCK®*

This is the essential armorer's tool for Glock owners. Precisely-machined steel matches the quality of your gun. It combines the ability to completely disassemble your gun for cleaning and maintenance with the ability to change front sights.

ITEM # AVGLOCK21 | MSRP \$17.99

*DISCLAIMER: This product is not manufactured, authorized, endorsed, or warranted by GLOCK. GLOCK does not warrant or represent that this product is compatible with GLOCK pistols. "GLOCK" is a federally registered trademark of GLOCK, Inc. and is one of many trademarks owned by GLOCK, Inc. and GLOCK Ges.m.b.H. New Revo Brand Group, LLC, d/b/a Real Avid is not affiliated in any manner with, or otherwise endorsed by, GLOCK, Inc. or GLOCK Ges.m.b.H.

MAGAZINE QUICK-DISASSEMBLY TOOL

CHANGE BASE PLATES OR DISASSEMBLE GLOCK MAGAZINES FOR SAFE AND EASY CLEANING.



MAGAZINE UNLOADER



SMART MAG TOOL™ FOR GLOCK®*

Change base plates or disassemble Glock magazines for safe and easy cleaning. No fumbling, no need for an extra hand, no out-of-control springs launching across the room. The Smart Mag Tool for Glock simplifies the process by allowing you to break open the baseplate, and slide it off while retaining the spring in a secure position.

ITEM # AVGLOCKMT | MSRP \$14.99

NEXT-GEN CLEANING MAT WITH INTEGRATED PARTS TRAY



SMART MAT® FOR GLOCK®*

This mat was built by people who know guns inside and out and were fed up with the old way of doing things. It is the perfect size to handle a fieldstripped Glock with the visible instructions to help you break it down. The attached parts tray ensures your pins and springs are never lost again.

ITEM # AVGLOCKSM | MSRP \$19.99

NEW

BORN READY.™



PURPOSE-BUILT CARRY KNIVES

The philosophy is simple: being READY transcends a mere state of mind; it is a commitment to oneself and loved ones. Born from the Real Avid culture, these blades are crafted to confront the toughest challenges head-on. With a foundation grounded in proven real-world performance, passion and an unwavering commitment to innovation, Real Avid Blades are not just ready – they are BORN READY for whatever life throws your way.

RAV™-1

Handle Material
Nylon
Blade Length
3.25 inch.
Blade Profile
Modified Clip Point
Blade Material
4Cr14
Blade Finish
Black Oxide
Lock Type
Liner Lock



RAV™-2

Handle Material
Aluminum
Blade Length
3.25 inch.
Blade Profile
Drop Point
Blade Material
8Cr13MoV
Blade Finish
Black Oxide
Lock Type
Liner Lock
Spring Assist



RAV™-3

Handle Material
Aluminum + SS
Blade Length
3.25 inch.
Blade Profile
Drop Point
Blade Material
8Cr13MoV
Blade Finish
Black Oxide
Lock Type
Liner Lock
Spring Assist



RAV™-4

Handle Material
Glass-Filled Nylon
Blade Length
3.25 inch.
Blade Profile
Drop Point
Blade Material
8Cr13MoV
Blade Finish
Black Oxide
Lock Type
Axis Lock
Spring Assist



RAV™-5

Handle Material
Aluminum + CF
Blade Length
3.4 inch.
Blade Profile
Drop Point
Blade Material
8Cr13MoV
Blade Finish
Titanium
Lock Type
Liner Lock
Spring Assist



RAV™-6

Handle Material
Aluminum + CF
Blade Length
3.4 inch.
Blade Profile
Tanto
Blade Material
8Cr13MoV
Blade Finish
Titanium
Lock Type
Liner Lock
Spring Assist



RAV™-7

Handle Material
G10
Blade Length
3.25 inch.
Blade Profile
Drop Point
Blade Material
8Cr13MoV
Blade Finish
Titanium
Lock Type
Liner Lock
Spring Assist



REAL AVID BLADES - RAV SERIES

Being READY is more than a state of mind, it's a way of life and a commitment to yourself and the ones you love. Real Avid Blades are BORN READY for the toughest challenges encountered by your carry knife. Born from the Real Avid culture of proven real-world performance, passion and a relentless pursuit of innovation, these blades are purpose-built. They're BORN READY.

NEW RAV-1
NEW RAV-2
NEW RAV-3
NEW RAV-4
NEW RAV-5
NEW RAV-6
NEW RAV-7

ITEM # AVRAV1
ITEM # AVRAV2
ITEM # AVRAV3
ITEM # AVRAV4
ITEM # AVRAV5
ITEM # AVRAV6
ITEM # AVRAV7

MSRP \$24.99
MSRP \$29.99
MSRP \$34.99
MSRP \$39.99
MSRP \$44.99
MSRP \$44.99
MSRP \$49.99



UNWAVERING COMMITMENT.

We all choose and are sometimes given different missions in our lives. The success or failure of those missions often hinges upon who you choose as your partner. Real Avid hungers to make a difference. To be real in our relationships. To go deeper and not compromise in our search for what's important. To serve our customers by inventing new and smarter ways to solve real-world problems for gun owners. We'll know we've succeeded when we earn the right to be your partner in the missions that you live to achieve.

For the owners of Real Avid, our partner in all of our missions is Jesus Christ. Everything that we do is gently governed by our faith in who He is and how He has changed our lives. It guides our business practices, fuels our creativity and drives us to do everything that we can to honor Him. He leads us to serve others with love and grace and to show by example what real faith looks like in a hurting world. We hope that ultimately, He becomes your partner in your life's mission.

John 3:16 "For God so loved the world that He gave his one and only son, that whoever believes in Him will not perish but have eternal life."



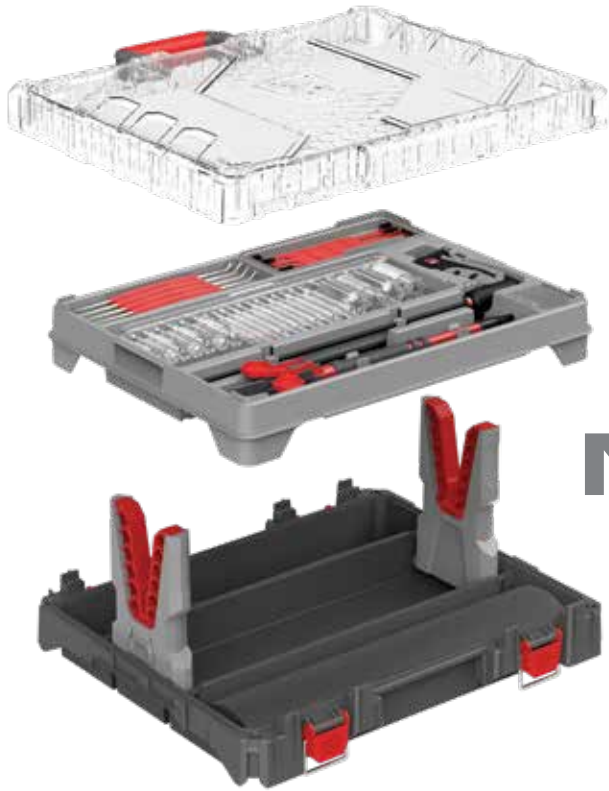

NEXT LEVEL

***DISCLAIMER:** The products in this catalog are not manufactured, authorized, endorsed, or warranted by GLOCK. GLOCK does not warrant or represent that this product is compatible with GLOCK pistols. "GLOCK" is a federally registered trademark of GLOCK, Inc. and is one of many trademarks owned by GLOCK, Inc. and GLOCK Ges.m.b.H. New Revo Brand Group, LLC, d/b/a Real Avid is not affiliated in any manner with, or otherwise endorsed by, GLOCK, Inc. or GLOCK Ges.m.b.H.

****DISCLAIMER:** The products in this catalog are not manufactured, authorized, endorsed, or warranted by ArmaLite, Inc. ArmaLite, Inc. does not warrant or represent that this product is compatible with AR-10. "AR-10" is a federally registered trademark of ArmaLite, Inc. New Revo Brand Group, LLC, d/b/a Real Avid is not affiliated in any manner with, or otherwise endorsed by ArmaLite, Inc.



5480 NATHAN LANE NORTH, SUITE 120
MINNEAPOLIS, MN 55442 | 800.286.0567

REALAVID.COM

©2024 NEW REVO BRAND GROUP