



CLONE TENT

0.6M HIGH 0.75 x 0.5M

8553

INSTRUCTION MANUAL

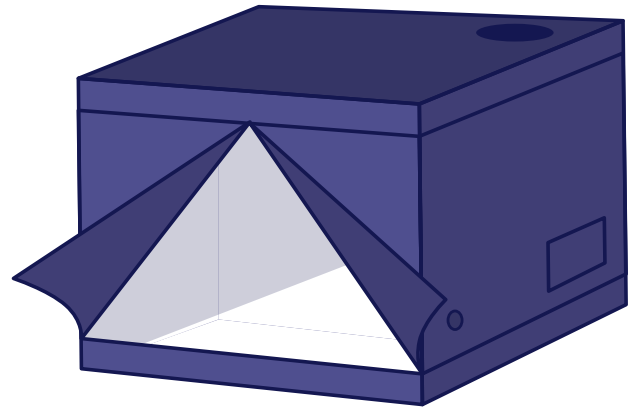

WHAT'S IN THE BOX

Please take the time, before assembling tent, to make sure all contents are present within this box.

8



2



4



A 71cm

4

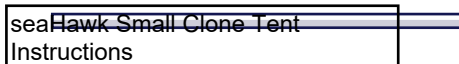

C 56cm

4



D 46cm

1



E 50cm

1



F 75cm

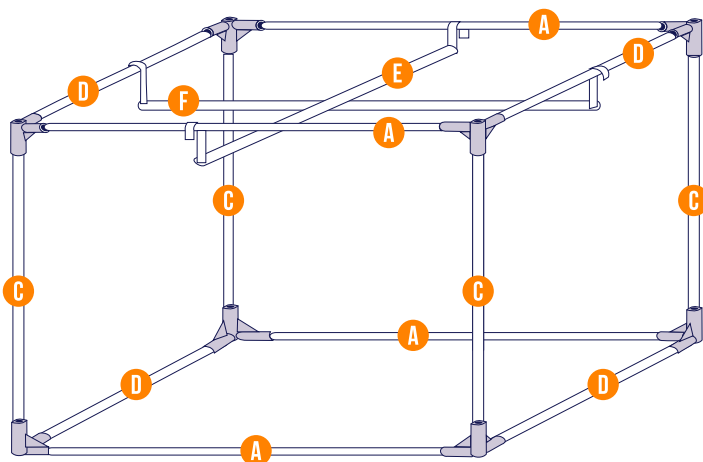

FRONT

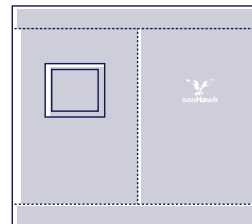

RHS

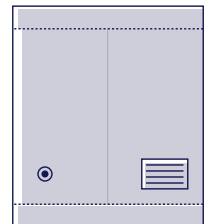

REAR

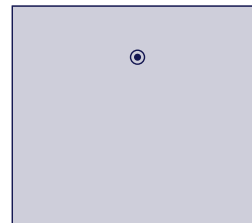

LHS

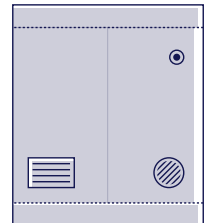

ROOF



seaHawk TENT KEY	
ZIPPER DOOR/ACCESS	OUTLET VENT 175 #
WINDOW	INTAKE PORT 175 #
AIR INTAKE	CABLE PORT 100 #

ASSEMBLY INSTRUCTIONS

STEP 1

Construct the metal tent frame by assembling the metal poles, corners, and connectors as per diagram. **To avoid damage, it is very important to check that all the poles are pushed completely into each corner/connector/joiner. Use a rubber mallet to gently tap fittings into the poles if necessary.** Failure to do so will not only make the tent cover difficult to fit but may also stretch the seams and allow emissions of light from the functioning tent.

STEP 2

Un-zip the zipper systems all the way.

STEP 3

Locate the tents' roof (*Refer PIC A*) and place neatly and carefully over all 4 corners of the top frame ensuring a snug fit. **To avoid damage, it is important that you hang the shallow and deep bars before doing the next step.**

STEP 4

Slip the base section of the tent cover beneath assembled "A" and "D" poles, and ensure it fits in a neat and precise manner around the tent frame corners and sides (*Refer PIC B*).

STEP 5

Close up the zipper system carefully. You may have to push the upright poles in as you zip up around each corner (*Refer PIC C*).

STEP 6

Attach waterproof floor tray in place and Nylon fabric straps. Zip up the zipper on the front (*Refer PIC D*).

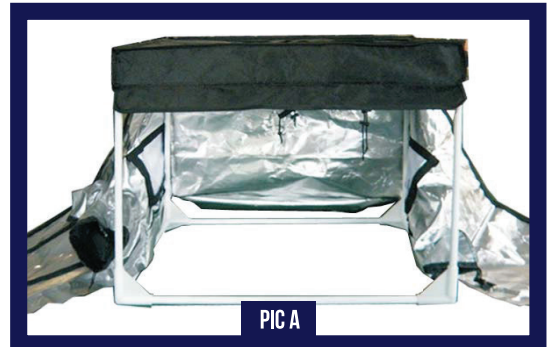

PIC A



PIC B



PIC C



PIC D

DISMANTLING OF SMART TENT

- 1 Ensure the tent is clean and dry before dismantling.
- 2 Reverse the operation as per above instruction. (**Step 6 > Step 5 > Step 4 > Step 3 > Step 2 > Step 1**) To ensure your **Smart Tent** maintains the same "lightproof" quality, always dismantle carefully and avoid stretching the seams of the tent cover.



seaHawk is distributed in Australia by Holland Forge PTY LTD.





SMART TENT WARRANTY

IMPORTANT INFORMATION

*Your Smart Tent is covered by a 12 month manufacturer's warranty.**

Holland Forge will repair or replace your **seaHawk Tent** if the product requires repair due to a manufacturing or materials defect (such as faulty stitching, delamination, faulty fittings, or faulty material).

The manufacturer's warranty is limited to manufacturing or materials defects. This does not include damage caused by wear and tear, condensation, dragging, abuse or misuse, accidents, falling objects, incorrect setup, burn holes, extreme exposure, mold, or damage caused by animals.

When setting up your **Smart Tent** for the first time, please inspect it thoroughly for any defects or missing parts. When attaching the poles to the corners/connectors/joiners, make sure they are firmly in place to avoid unnecessary stretching of the tent's fabric. Use a rubber mallet to gently tap fittings in if necessary.

Please fill out date and place of purchase on your tent carton and keep in a safe place for future reference.

Email info@hollandforge.com.au to notify us of any warranty issues. Please include Date and Place of Purchase along with Batch Number and Product Code and any photo's of the issue to help us assist with your warranty claim.



CONGRATULATIONS ON YOUR PURCHASE OF A SEAHAWK SMART TENT

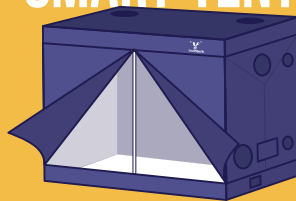

***Please note your zippers are only covered by a 3 month defect warranty.**

The zips on our tents are heavy duty. If there is an issue with a zip upon receiving your tent, please let us know immediately as we can cover this under warranty. Further down the line however, we do not cover the zips under warranty, as they can break if mistreated. For example; if the tent is exposed to large amounts of positive or negative pressure or if the zips are forced, your zips are not likely to last very long. Please take care of your zips by always using two hands to guide them and to not place undue pressure on them when opening or closing them. We would also recommend the use of a zipper lubricant to prolong the life of your zipper.



seaHawk is distributed in Australia
by Holland Forge PTY LTD.