



TEST REPORT

Reference No..... : WTU21N09102500E
Applicant..... : LUMATEK LTD.
Address..... : Ewropa Business centre Level 3 – 701 Dun Karm Street
Birkirkara BKR 9034 MALTA
Manufacturer..... : LUMATEK LTD.
Address..... : Ewropa Business centre Level 3 – 701 Dun Karm Street
Birkirkara BKR 9034 MALTA
Product Name..... : LED Luminaires
Model No..... : ATS200W PRO
Standards..... : EN IEC 55015:2019+A11:2020
EN 61547:2009
EN IEC 61000-3-2:2019
EN 61000-3-3:2013+A1:2019
Date of Receipt sample.... : 2021-05-19
Date of Test..... : 2021-05-24 to 2021-05-28
Date of Issue..... : 2021-10-18
Test Report Form No..... : WEL-55015A-03B
Test Result..... : **Pass**

Remarks:

The results shown in this test report refer only to the sample(s) tested, this test report cannot be reproduced, except in full, without prior written permission of the company. The report would be invalid without specific stamp of test institute and the signatures of compiler and approver.

Prepared By:

Waltek Testing Group (Ningbo) Co., Ltd.

Address: Zone 3, 1/F., No.6, Building 011, No.1177, Lingyun Road, Ningbo
Hi-Tech Zone, Yinzhou District, Ningbo, Zhejiang, China

Tel: +86-574-8749 3888

Fax: +86-574-8386 8018

Compiled by:

Shouyin Wang / Project Engineer

Approved by:

Jianzhong Mao / Manager



1 Test Summary

| EMISSION | | | |
|--|----------------------------|----------------------|--------|
| Test Item | Test Standard | Class / Severity | Result |
| Mains Terminal Disturbance Voltage, 9kHz to 30MHz | EN IEC 55015:2019+A11:2020 | Clause 4.3.1 | Pass |
| Radiated electromagnetic disturbance, 9kHz to 30MHz | EN IEC 55015:2019+A11:2020 | Clause 4.5.2 | Pass |
| Radiated Emission, 30MHz to 1GHz | EN IEC 55015:2019+A11:2020 | Clause 4.5.3 | Pass |
| Harmonic Current emission | EN IEC 61000-3-2:2019 | Clause 7 | Pass |
| Voltage Changes, Voltage Fluctuation and Flicker | EN 61000-3-3:2013+A1:2019 | Clause 5 | Pass |
| IMMUNITY (EN 61547:2009) | | | |
| Test Item | Test Method | Performance Criteria | Result |
| Electrostatic Discharge(ESD) | IEC 61000-4-2:2008 | B | Pass |
| Radio-frequency electromagnetic fields (80MHz to 1GHz) | IEC 61000-4-3:2006+A1:2007 | A | Pass |
| Electrical Fast Transients (EFT) | IEC 61000-4-4:2004 | B | Pass |
| Surge | IEC 61000-4-5:2005 | C | Pass |
| Injected Currents, 0.15MHz to 80MHz | IEC 61000-4-6:2008 | A | Pass |
| Power-frequency magnetic field | IEC 61000-4-8:1993+A1:2000 | A | N/A |
| Voltage Dips | IEC 61000-4-11:2004 | C | Pass |
| Voltage short interruptions | | B | Pass |

Remark:

Pass

Test item meets the requirement

Fail

Test item does not meet the requirement

N/A

Test case does not apply to the test object



2 Contents

| | Page |
|---|-----------|
| COVER PAGE | 1 |
| 1 TEST SUMMARY | 2 |
| 2 CONTENTS | 3 |
| 3 GENERAL INFORMATION | 5 |
| 3.1 GENERAL DESCRIPTION OF E.U.T. | 5 |
| 3.2 DETAILS OF E.U.T. | 5 |
| 3.3 DESCRIPTION OF SUPPORT UNITS | 5 |
| 3.4 STANDARDS APPLICABLE FOR TESTING | 5 |
| 3.5 SUBCONTRACTED | 6 |
| 3.6 ABNORMALITIES FROM STANDARD CONDITIONS | 6 |
| 4 EQUIPMENT USED DURING TEST | 7 |
| 4.1 MEASUREMENT UNCERTAINTY | 8 |
| 5 EMISSION TEST RESULTS | 9 |
| 5.1 MAINS TERMINALS DISTURBANCE VOLTAGE, 9KHZ TO 30MHZ | 9 |
| 5.1.1 E.U.T. Operation | 9 |
| 5.1.2 Block Diagram of Test Setup | 9 |
| 5.1.3 Measurement Data | 9 |
| 5.1.4 Mains Terminals Disturbance Voltage Test Data | 10 |
| 5.2 RADIATED ELECTROMAGNETIC DISTURBANCE, 9KHZ TO 30MHZ | 12 |
| 5.2.1 E.U.T. Operation | 12 |
| 5.2.2 Block Diagram of Test Setup | 13 |
| 5.2.3 Measurement Data | 13 |
| 5.2.4 Radiated Electromagnetic Disturbance test data, 9kHz to 30MHz | 14 |
| 5.3 RADIATED EMISSION, 30MHZ TO 1GHZ | 17 |
| 5.3.1 E.U.T. Operation | 17 |
| 5.3.2 Block Diagram of Setup | 17 |
| 5.3.3 Measurement Data | 18 |
| 5.3.4 Radiated Emission test data, 30MHz to 1GHz | 19 |
| 5.4 HARMONICS CURRENT EMISSION | 21 |
| 5.4.1 E.U.T. Operation | 21 |
| 5.4.2 Block Diagram of Setup | 21 |
| 5.4.3 Harmonic Current Emission Test Data | 22 |
| 5.5 VOLTAGE CHANGES, VOLTAGE FLUCTUATION AND FLICKER | 23 |
| 6 IMMUNITY TEST RESULTS | 24 |
| 6.1 PERFORMANCE CRITERIA | 24 |
| 6.2 ELECTROSTATIC DISCHARGE (ESD) | 24 |
| 6.2.1 E.U.T. Operation | 24 |
| 6.2.2 Block Diagram of Setup | 25 |
| 6.2.3 Direct Discharge Test Results | 25 |
| 6.2.4 Indirect Discharge Test Results | 26 |
| 6.3 RADIO-FREQUENCY ELECTROMAGNETIC FIELDS, 80MHZ TO 1GHZ | 26 |
| 6.3.1 E.U.T. Operation | 26 |
| 6.3.2 Block Diagram of Setup | 27 |
| 6.3.3 Test Results | 27 |
| 6.4 ELECTRICAL FAST TRANSIENTS (EFT) | 28 |
| 6.4.1 E.U.T. Operation | 28 |
| 6.4.2 Block Diagram of Setup | 29 |
| 6.4.3 Test Results | 29 |
| 6.5 SURGE | 30 |



| | | |
|----------|---|-----------|
| 6.5.1 | E.U.T. Operation | 30 |
| 6.5.2 | Block Diagram of Setup | 30 |
| 6.5.3 | Test Results | 30 |
| 6.6 | INJECTED CURRENTS IMMUNITY 0.15MHZ TO 80MHZ | 31 |
| 6.6.1 | E.U.T. Operation | 31 |
| 6.6.2 | Block Diagram of Setup | 31 |
| 6.6.3 | Test Results | 31 |
| 6.7 | VOLTAGE DIPS AND INTERRUPTIONS | 33 |
| 6.7.1 | E.U.T. Operation | 33 |
| 6.7.2 | Block Diagram of Setup | 33 |
| 6.7.3 | Test Results | 33 |
| 7 | PHOTOGRAPHS – TEST SETUP | 34 |
| 7.1 | PHOTOGRAPH – MAINS TERMINAL DISTURBANCE VOLTAGE TEST SETUP | 34 |
| 7.2 | PHOTOGRAPH – RADIATED ELECTROMAGNETIC DISTURBANCE TEST SETUP, 9kHz TO 30MHz | 34 |
| 7.3 | PHOTOGRAPH – RADIATED EMISSION TEST SETUP, 30MHz TO 1GHz | 35 |
| 7.4 | PHOTOGRAPH – HARMONIC CURRENT AND FLICKER TEST SETUP | 35 |
| 7.5 | PHOTOGRAPH – ESD IMMUNITY TEST SETUP | 36 |
| 7.6 | PHOTOGRAPH – RADIO-FREQUENCY ELECTROMAGNETIC FIELDS IMMUNITY TEST SETUP | 36 |
| 7.7 | PHOTOGRAPH – EFT & VOLTAGE DIPS AND INTERRUPTIONS IMMUNITY TEST SETUP | 37 |
| 7.8 | PHOTOGRAPH – SURGE IMMUNITY TEST SETUP | 37 |
| 7.9 | PHOTOGRAPH – INJECTED CURRENTS IMMUNITY TEST SETUP | 38 |
| 8 | PHOTOGRAPHS – CONSTRUCTIONAL DETAILS | 39 |
| 8.1 | EUT – FRONT VIEW | 39 |
| 8.2 | EUT – BACK VIEW | 40 |

WALTEK



3 General Information

3.1 General Description of E.U.T.

| | | |
|-------------------------------|---|---|
| Product Name | : | LED Luminaires |
| Model No. | : | ATS200W PRO |
| Protection Class | : | Class I |
| Remark | : | <ol style="list-style-type: none"> 1. The EUT (equipment under test) is an ordinary LED Luminaires for Lighting and similar use. For the further information, refer to the user's manual. 2. For details information, refer to the section 3.2. 3. For the test results, the EUT had been tested with the rated input range. But only the worst case was shown in test report. |

3.2 Details of E.U.T.

| No. | Model | Rated Input | Rated Power | Note |
|-----|-------------|--------------------------|-------------|------|
| 1. | ATS200W PRO | 220-240V~/230V~, 50/60Hz | 200W | / |

3.3 Description of Support Units

The EUT has been tested as an independent unit. ATS200W PRO is the tested sample. All tests were performed in the condition of 230V~, 50Hz input.

3.4 Standards Applicable for Testing

The tests were performed according to following standards:

| | |
|----------------------------|--|
| EN IEC 55015:2019+A11:2020 | Limits and methods of measurement of radio disturbance characteristics of electrical lighting and similar equipment |
| EN 61547:2009 | Equipment for general lighting purposes — EMC immunity requirements |
| EN IEC 61000-3-2:2019 | Electromagnetic compatibility (EMC) Part 3-2: Limits — Limits for harmonic current emissions (equipment input current ≤ 16 A per phase). |
| EN 61000-3-3:2013+A1:2019 | Electromagnetic compatibility (EMC) Part 3-3: Limits — Limitation of voltage changes, voltage fluctuations and flicker in public low-voltage supply systems, for equipment with rated current ≤ 16 A per phase and not subject to conditional connection. |



3.5 Subcontracted

Whether parts of tests for the product have been subcontracted to other labs:

Yes No

If Yes, list the related test items and lab information:

Test items: Radio-frequency electromagnetic fields (80MHz to 1GHz)

Lab information: Waltek Testing Group (Foshan) Co., Ltd.

Address: No.13-19, 2/F., 2nd Building, Sunlink International Machinery City,
Chencun, Shunde District, Foshan, Guangdong, China

3.6 Abnormalities from Standard Conditions

None.

WALTEK



4 Equipment Used during Test

| Mains Terminal Disturbance Voltage (Conducted Emission) | | | | | |
|---|---|--------------|-----------------------|------------|--------------------|
| Item | Equipment | Manufacturer | Model No. | Serial No. | Calibration Status |
| 1 | EMI Test Receiver | R&S | ESCI | 101406 | Valid |
| 2 | TWO-LINE V-NETWORK | R&S | ENV216 | 101208 | Valid |
| Radiated electromagnetic disturbance(9kHz to 30MHz) | | | | | |
| Item | Equipment | Manufacturer | Model No. | Serial No. | Calibration Status |
| 1 | EMI Test Receiver | R&S | ESCI | 101406 | Valid |
| 2 | 3-dimensional large loop antenna | SCHWARZBECK | HXYZ9170 | 256 | Valid |
| 3m Semi-anechoic Chamber for Radiated Emission | | | | | |
| Item | Equipment | Manufacturer | Model No. | Serial No. | Calibration Status |
| 1 | EMI Test Receiver | R&S | ESR7 | 101777 | Valid |
| 2 | TRILOG Biconic logarithmic periodic broadband antenna | SCHWARZBECK | VULB9163 | 01025 | Valid |
| 3 | coupling-Decoupling Network | SCHWARZBECK | CDNE M3 | 00081 | Valid |
| 4 | coupling-Decoupling Network | SCHWARZBECK | CDNE M2 | 00093 | Valid |
| Harmonics and Flicker Measuring System | | | | | |
| Item | Equipment | Manufacturer | Model No. | Serial No. | Calibration Status |
| 1 | Harmonics /Flicker Analyzer | KIKUSUI | KHA1000 | TL002966 | Valid |
| 2 | line Power Supply | KIKUSUI | PCR4000LE | TL003094 | Valid |
| 3 | Line Impedance Network | KIKUSUI | LIN40MA- PCR-LE | TM001297 | Valid |
| ESD | | | | | |
| Item | Equipment | Manufacturer | Model No. | Serial No. | Calibration Status |
| 1 | electrostatic discharge generator | TESEQ | NSG437 | 699 | Valid |
| Radio-frequency electromagnetic fields | | | | | |
| Item | Equipment | Manufacturer | Model No. | Serial No. | Calibration Status |
| 1 | RF Power Amplifier | OPHIR | 5225R | 1051/1712 | Valid |
| 2 | RF Power Amplifier | OPHIR | 5293RE | 1051/171 | Valid |
| 3 | Stacked double logarithmic periodic antenna | SCHWARZBECK | STLP9128E- SPECIAL | 142 | Valid |
| 4 | Stacked double logarithmic periodic | SCHWARZBECK | STLP 9149 | 476 | Valid |



| | | | | | |
|---|----------------------|---------|--------|------------|-------|
| | antenna | | | | |
| 5 | RF signal generator | Agilent | N5181A | MY48080720 | Valid |
| 6 | Power meter | RS | NRP6A | 101133 | Valid |
| 7 | Power meter | RS | NRP6A | 101134 | Valid |
| 8 | Electric field probe | Narda | EP 601 | 611WX70311 | Valid |

EFT & Voltage Dips and Interruptions

| Item | Equipment | Manufacturer | Model No. | Serial No. | Calibration Status |
|------|----------------------------------|--------------|-----------|------------|--------------------|
| 1 | Multifunction Generator Systems | TESEQ | NSG3040 | 2094 | Valid |
| 2 | Single way manual Step regulator | TESEQ | INA 6501 | 243 | Valid |

Surge

| Item | Equipment | Manufacturer | Model No. | Serial No. | Calibration Status |
|------|---------------------------------|--------------|-----------|------------|--------------------|
| 1 | Multifunction Generator Systems | TESEQ | NSG3060 | 1654 | Valid |
| 2 | coupling-Decoupling Network | TESEQ | CDN3061 | 1485 | Valid |

Injected Currents

| Item | Equipment | Manufacturer | Model No. | Serial No. | Calibration Status |
|------|---|--------------|-----------|------------|--------------------|
| 1 | Test System for Conducted and Radiated Immunity | TESEQ | NSG4070 | 37519 | Valid |
| 2 | Coupling and Decoupling Network | TESEQ | CDN M016 | 37358 | Valid |
| 3 | Attenuator | TESEQ | ATN6075 | 36917 | Valid |

4.1 Measurement Uncertainty

| Test Item | Frequency Range | Uncertainty | Note |
|--------------------------------------|-----------------|-------------|------|
| Mains Terminal Disturbance Voltage | 9kHz~30MHz | ±2.66dB | (1) |
| Radiated electromagnetic disturbance | 9kHz~30MHz | ±3.00dB | (1) |
| Radiated Emission | 30MHz~1GHz | ±5.03dB | (1) |

(1) This uncertainty represents an expanded uncertainty expressed at approximately the 95% confidence level using a coverage factor of $k=2$.



5 Emission Test Results

5.1 Mains Terminals Disturbance Voltage, 9kHz to 30MHz

| | |
|-----------------------|--|
| Test Requirement..... | : EN IEC 55015 |
| Test Method..... | : CIPR 16-2-1 and Clause 8.3 of EN IEC 55015 |
| Test Result..... | : Pass |
| Frequency Range..... | : 9kHz to 30MHz |
| Class/Severity..... | : Table 1 of EN IEC 55015 |

5.1.1 E.U.T. Operation

Operating Environment:

Temperature : 22.8°C

Humidity..... : 53%RH

EUT Operation:

Input Voltage : 230V~, 50Hz

Operating Mode..... : On mode

5.1.2 Block Diagram of Test Setup

The Mains Terminals Disturbance Voltage tests were performed in accordance with the EN IEC 55015.

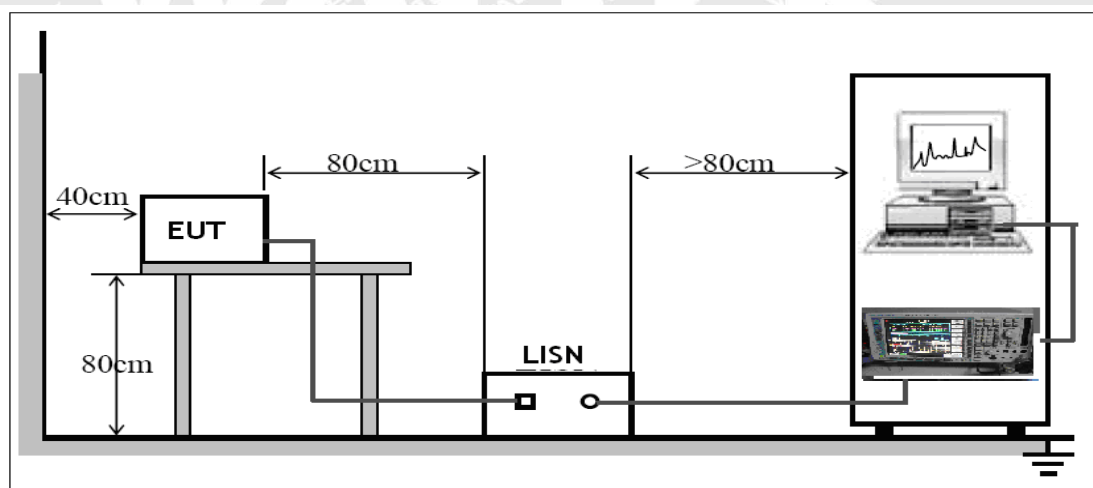

5.1.3 Measurement Data

The maximised peak emissions from the EUT was scanned and measured for both the Live and Neutral Lines. Quasi-peak & average measurements were performed if peak emissions were within 6dB of the average limit line.



5.1.4 Mains Terminals Disturbance Voltage Test Data

Live Line

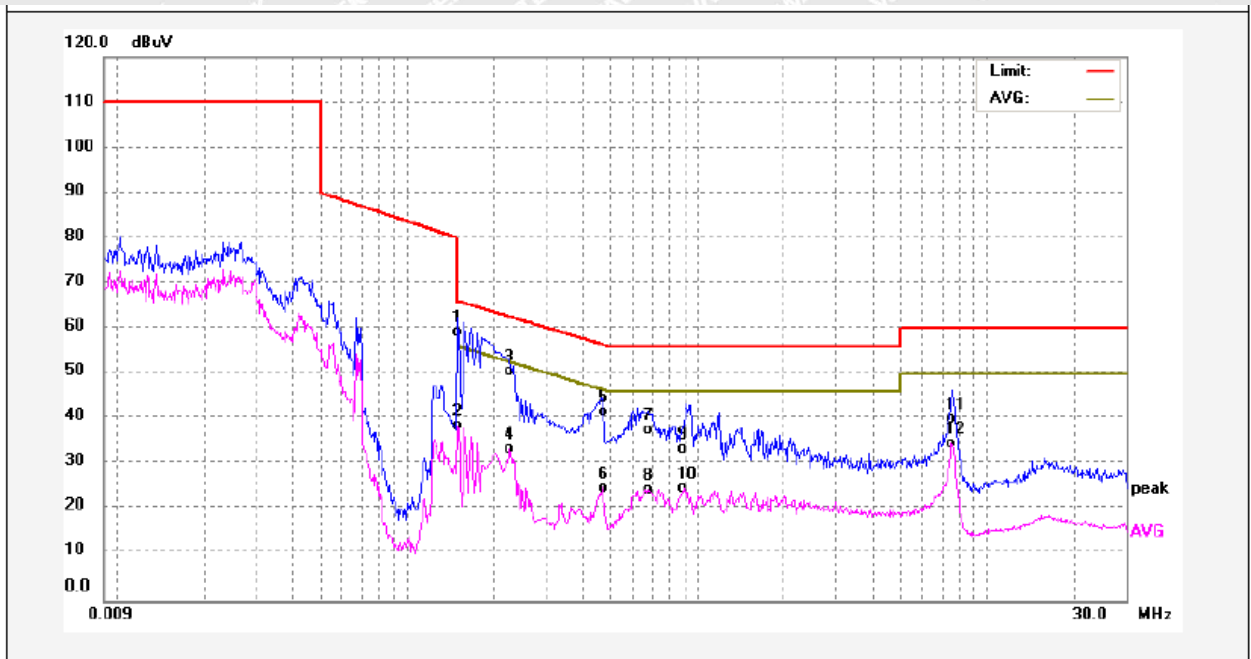

| No. | Freq. (MHz) | Reading (dBuV) | Factor (dB) | Result (dBuV) | Limit dBuV | Margin (dB) | Detector | Remark |
|-----|-------------|----------------|-------------|---------------|------------|-------------|----------|--------|
| 1 | 0.1501 | 49.53 | 9.64 | 59.17 | 65.99 | -6.82 | QP | |
| 2 | 0.1501 | 28.90 | 9.64 | 38.54 | 55.99 | -17.45 | AVG | |
| 3 | 0.2261 | 41.01 | 9.63 | 50.64 | 62.59 | -11.95 | QP | |
| 4 | 0.2261 | 23.92 | 9.63 | 33.55 | 52.59 | -19.04 | AVG | |
| 5 | 0.4741 | 31.89 | 9.63 | 41.52 | 56.44 | -14.92 | QP | |
| 6 | 0.4741 | 15.27 | 9.63 | 24.90 | 46.44 | -21.54 | AVG | |
| 7 | 0.6741 | 28.01 | 9.65 | 37.66 | 56.00 | -18.34 | QP | |
| 8 | 0.6741 | 14.87 | 9.65 | 24.52 | 46.00 | -21.48 | AVG | |
| 9 | 0.8981 | 23.74 | 9.66 | 33.40 | 56.00 | -22.60 | QP | |
| 10 | 0.8981 | 14.95 | 9.66 | 24.61 | 46.00 | -21.39 | AVG | |
| 11 | 7.5301 | 30.09 | 9.87 | 39.96 | 60.00 | -20.04 | QP | |
| 12 | 7.5301 | 24.85 | 9.87 | 34.72 | 50.00 | -15.28 | AVG | |



Neutral Line

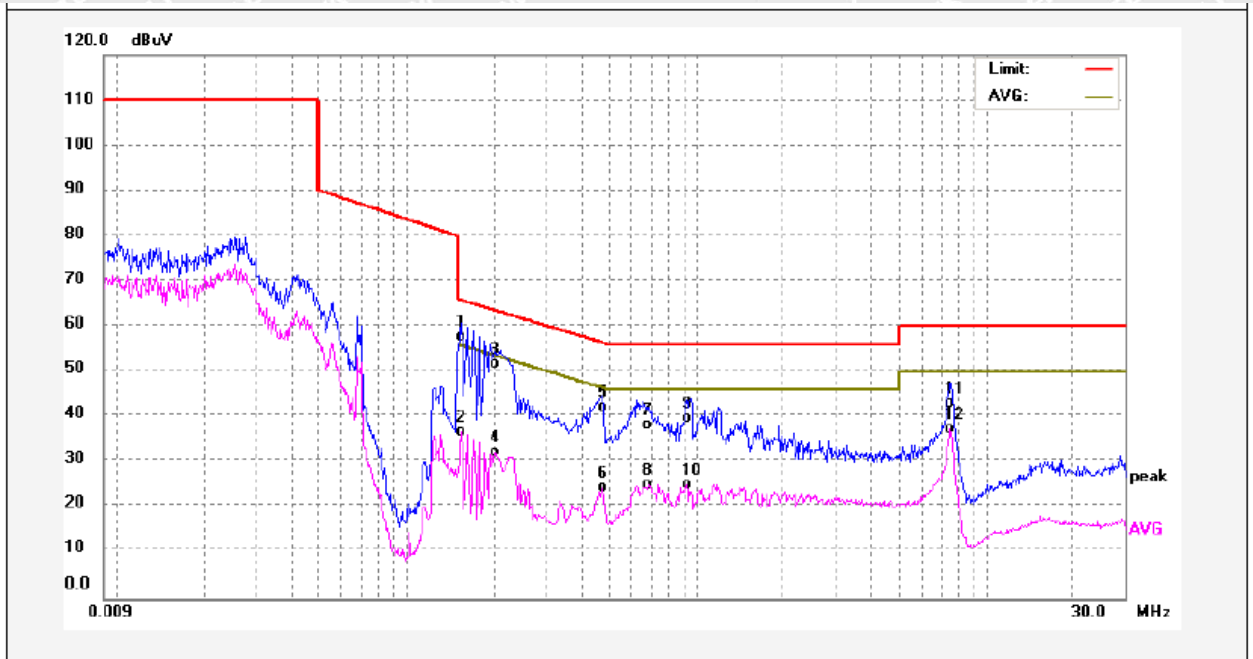

| No. | Freq. (MHz) | Reading (dBuV) | Factor (dB) | Result (dBuV) | Limit dBuV | Margin (dB) | Detector | Remark |
|-----|-------------|----------------|-------------|---------------|------------|-------------|----------|--------|
| 1 | 0.1541 | 48.19 | 9.64 | 57.83 | 65.77 | -7.94 | QP | |
| 2 | 0.1541 | 27.04 | 9.64 | 36.68 | 55.77 | -19.09 | AVG | |
| 3 | 0.2021 | 42.20 | 9.63 | 51.83 | 63.52 | -11.69 | QP | |
| 4 | 0.2021 | 22.59 | 9.63 | 32.22 | 53.52 | -21.30 | AVG | |
| 5 | 0.4781 | 32.58 | 9.63 | 42.21 | 56.37 | -14.16 | QP | |
| 6 | 0.4781 | 14.85 | 9.63 | 24.48 | 46.37 | -21.89 | AVG | |
| 7 | 0.6861 | 28.56 | 9.65 | 38.21 | 56.00 | -17.79 | QP | |
| 8 | 0.6861 | 15.43 | 9.65 | 25.08 | 46.00 | -20.92 | AVG | |
| 9 | 0.9261 | 30.09 | 9.66 | 39.75 | 56.00 | -16.25 | QP | |
| 10 | 0.9261 | 15.54 | 9.66 | 25.20 | 46.00 | -20.80 | AVG | |
| 11 | 7.5461 | 33.15 | 9.87 | 43.02 | 60.00 | -16.98 | QP | |
| 12 | 7.5461 | 27.52 | 9.87 | 37.39 | 50.00 | -12.61 | AVG | |



5.2 Radiated Electromagnetic Disturbance, 9kHz to 30MHz

| | | |
|-------------------------------|---|---|
| Test Requirement | : | EN IEC 55015 |
| Test Method | : | CISPR 16-2-3 and Clause 9.3.2 of EN IEC 55015 |
| Test Result | : | Pass |
| Frequency Range | : | 9kHz to 30MHz |
| Class/Severity | : | Table 7 and Table 8 of EN IEC 55015 |

5.2.1 E.U.T. Operation

Operating Environment:

Temperature : 22.8°C

Humidity..... : 53%RH

EUT Operation:

Input Voltage : 230V~, 50Hz

Operating Mode..... : On mode

WALTEK



5.2.2 Block Diagram of Test Setup

The Radiated Electromagnetic Disturbance (9kHz to 30MHz) test was performed in accordance with the EN IEC 55015.

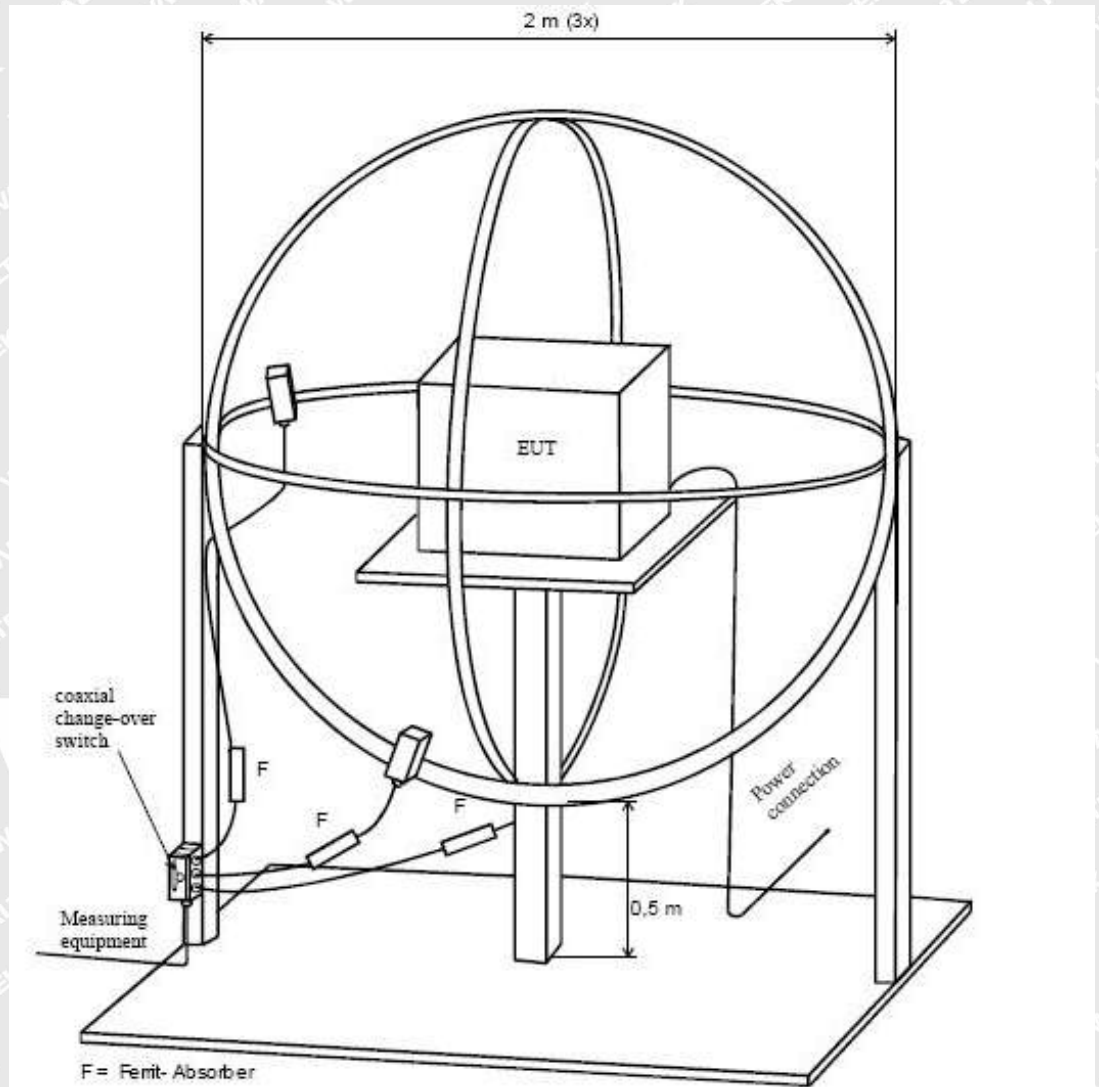

5.2.3 Measurement Data

According to the data in section 5.2.4, the EUT complied with the EN IEC 55015 standards.



5.2.4 Radiated Electromagnetic Disturbance test data, 9kHz to 30MHz

Loop X

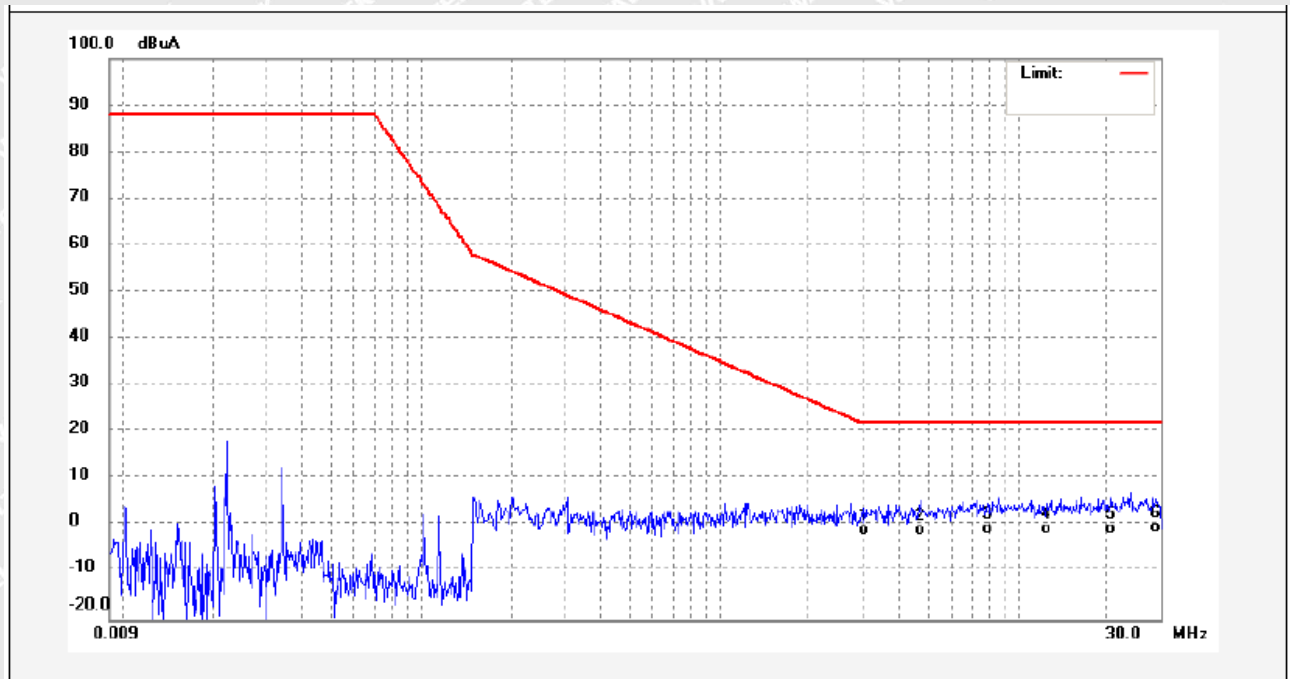

| No. | Freq. (MHz) | Reading (dBuA) | Factor (dB) | Result (dBuA) | Limit dBuA | Margin (dB) | Detector | Remark |
|-----|-------------|----------------|-------------|---------------|------------|-------------|----------|--------|
| 1 | 3.0701 | -34.60 | 33.61 | -0.99 | 22.00 | -22.99 | QP | |
| 2 | 4.7181 | -34.64 | 33.63 | -1.01 | 22.00 | -23.01 | QP | |
| 3 | 7.9021 | -34.23 | 33.70 | -0.53 | 22.00 | -22.53 | QP | |
| 4 | 12.3941 | -34.56 | 33.89 | -0.67 | 22.00 | -22.67 | QP | |
| 5 | 20.6541 | -34.55 | 34.01 | -0.54 | 22.00 | -22.54 | QP | |
| 6 | 29.0301 | -33.87 | 33.64 | -0.23 | 22.00 | -22.23 | QP | |



Loop Y

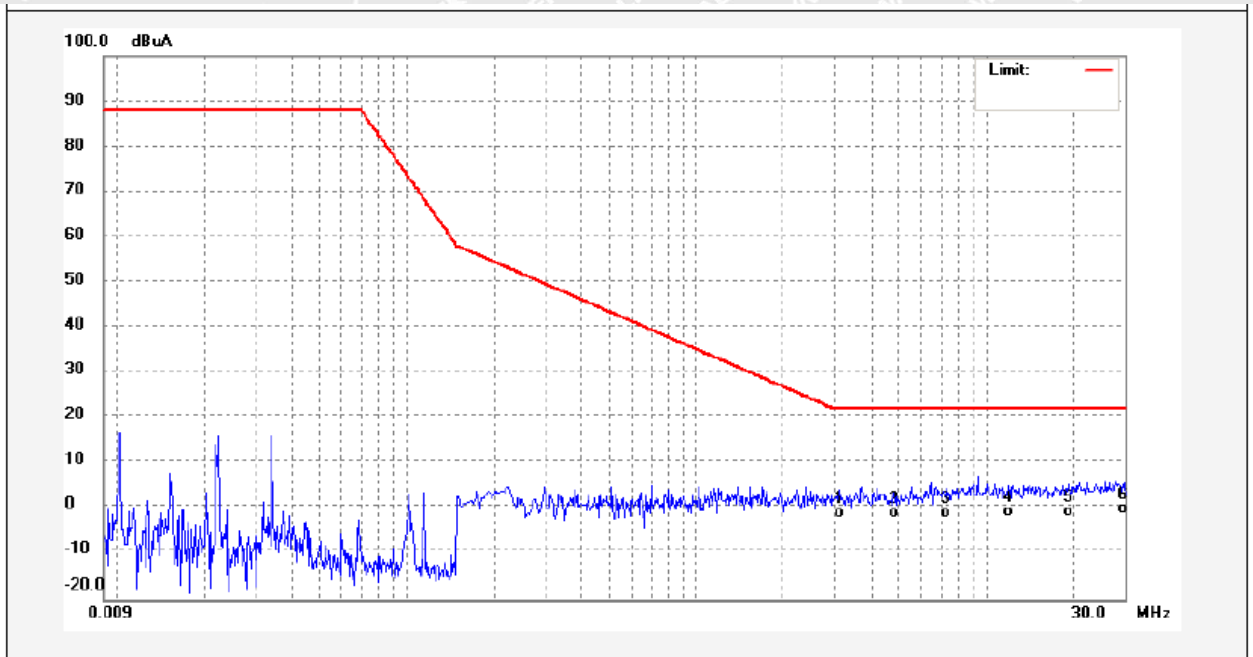

| No. | Freq. (MHz) | Reading (dBuA) | Factor (dB) | Result (dBuA) | Limit dBuA | Margin (dB) | Detector | Remark |
|-----|-------------|----------------|-------------|---------------|------------|-------------|----------|--------|
| 1 | 3.1221 | -34.59 | 33.61 | -0.98 | 22.00 | -22.98 | QP | |
| 2 | 4.8061 | -34.71 | 33.63 | -1.08 | 22.00 | -23.08 | QP | |
| 3 | 7.2741 | -34.54 | 33.71 | -0.83 | 22.00 | -22.83 | QP | |
| 4 | 11.9181 | -34.58 | 33.88 | -0.70 | 22.00 | -22.70 | QP | |
| 5 | 19.2741 | -34.62 | 34.03 | -0.59 | 22.00 | -22.59 | QP | |
| 6 | 29.9821 | -33.78 | 33.60 | -0.18 | 22.00 | -22.18 | QP | |



Loop Z

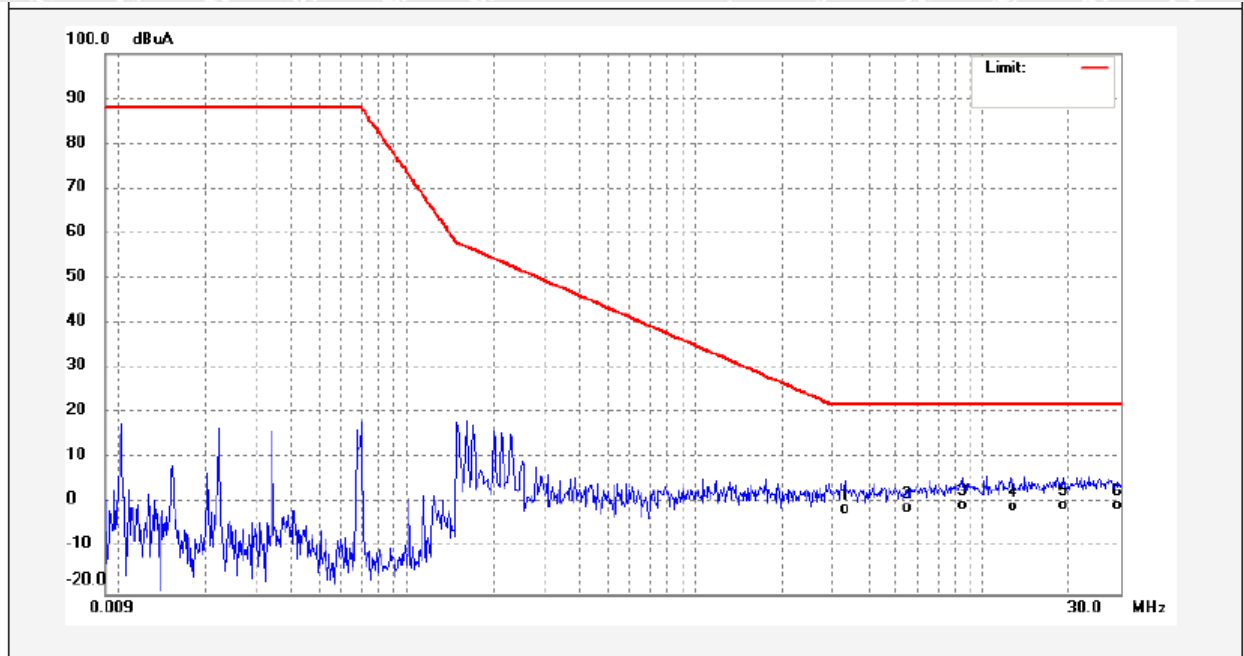

| No. | Freq. (MHz) | Reading (dBuA) | Factor (dB) | Result (dBuA) | Limit dBuA | Margin (dB) | Detector | Remark |
|-----|-------------|----------------|-------------|---------------|------------|-------------|----------|--------|
| 1 | 3.3181 | -34.71 | 33.60 | -1.11 | 22.00 | -23.11 | QP | |
| 2 | 5.4901 | -34.73 | 33.68 | -1.05 | 22.00 | -23.05 | QP | |
| 3 | 8.4781 | -34.02 | 33.72 | -0.30 | 22.00 | -22.30 | QP | |
| 4 | 12.7381 | -34.65 | 33.90 | -0.75 | 22.00 | -22.75 | QP | |
| 5 | 18.9141 | -34.43 | 34.02 | -0.41 | 22.00 | -22.41 | QP | |
| 6 | 29.3821 | -33.96 | 33.63 | -0.33 | 22.00 | -22.33 | QP | |



5.3 Radiated Emission, 30MHz to 1GHz

| | |
|-----------------------|----------------------------|
| Test Requirement..... | : EN IEC 55015 |
| Test Method..... | : CISPR 16-2-3 |
| Test Result..... | : Pass |
| Frequency Range..... | : 30MHz to 1GHz |
| Class/Severity..... | : Table 10 of EN IEC 55015 |

5.3.1 E.U.T. Operation

Operating Environment:

| | |
|------------------|----------|
| Temperature..... | : 22.7°C |
| Humidity..... | : 55%RH |

EUT Operation :

| | |
|---------------------|---------------|
| Input Voltage..... | : 230V~, 50Hz |
| Operating Mode..... | : On mode |

5.3.2 Block Diagram of Setup

The Radiated Emission tests were performed in the 3m Semi- Anechoic Chamber test site, using the setup accordance with the CISPR 16-2-3.

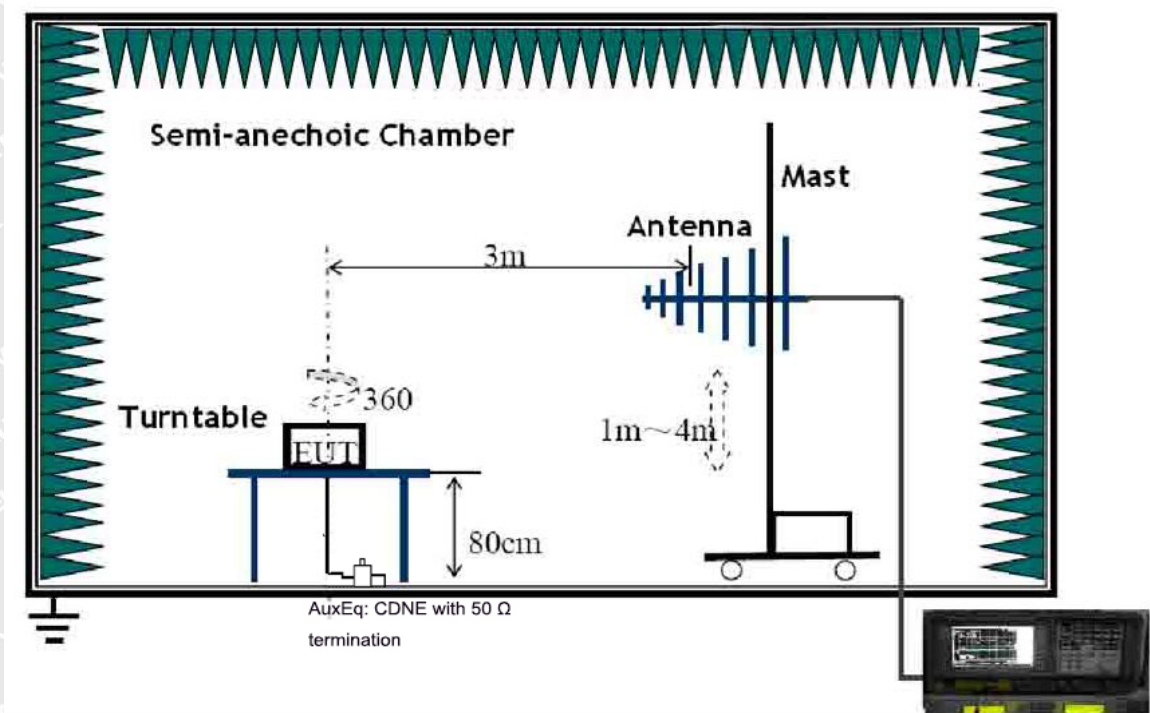



5.3.3 Measurement Data

The maximised peak emissions from the EUT was scanned and measured for Horizontal & Vertical polarisation. Quasi-peak measurements were performed if peak emissions were within 6dB of the limit line. According to the data in section 5.3.4, the EUT complied with the EN IEC 55015 standards.

WALTEK



5.3.4 Radiated Emission test data, 30MHz to 1GHz

Vertical

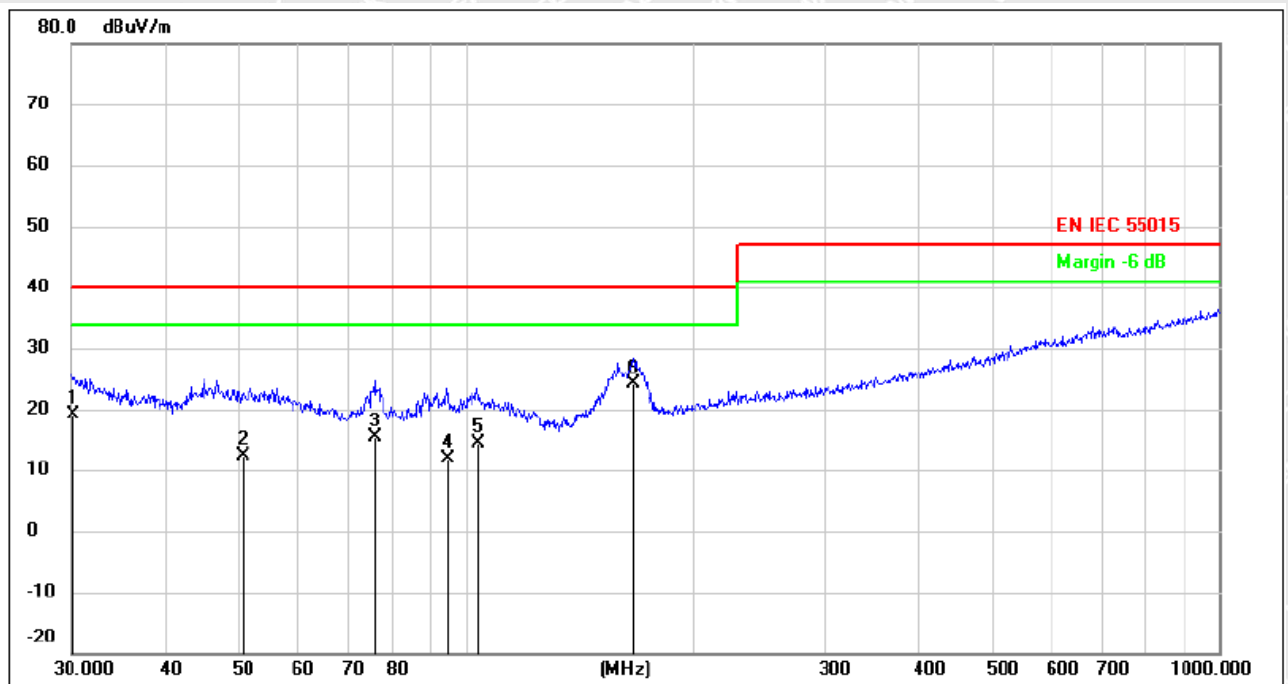

| No. | Frequency (MHz) | Reading (dBuV/m) | Correct dB/m | Result (dBuV/m) | Limit (dBuV/m) | Margin (dB) | Remark |
|-----|--------------------|---------------------|-----------------|--------------------|-------------------|----------------|--------|
| 1 | 30.1054 | 8.41 | 10.82 | 19.23 | 40.00 | -20.77 | QP |
| 2 | 50.7637 | -1.05 | 13.55 | 12.50 | 40.00 | -27.50 | QP |
| 3 | 75.7114 | 6.86 | 8.43 | 15.29 | 40.00 | -24.71 | QP |
| 4 | 94.4284 | 1.20 | 10.74 | 11.94 | 40.00 | -28.06 | QP |
| 5 | 103.8055 | 2.67 | 11.60 | 14.27 | 40.00 | -25.73 | QP |
| 6 | 167.2368 | 15.45 | 8.64 | 24.09 | 40.00 | -15.91 | QP |



Horizontal

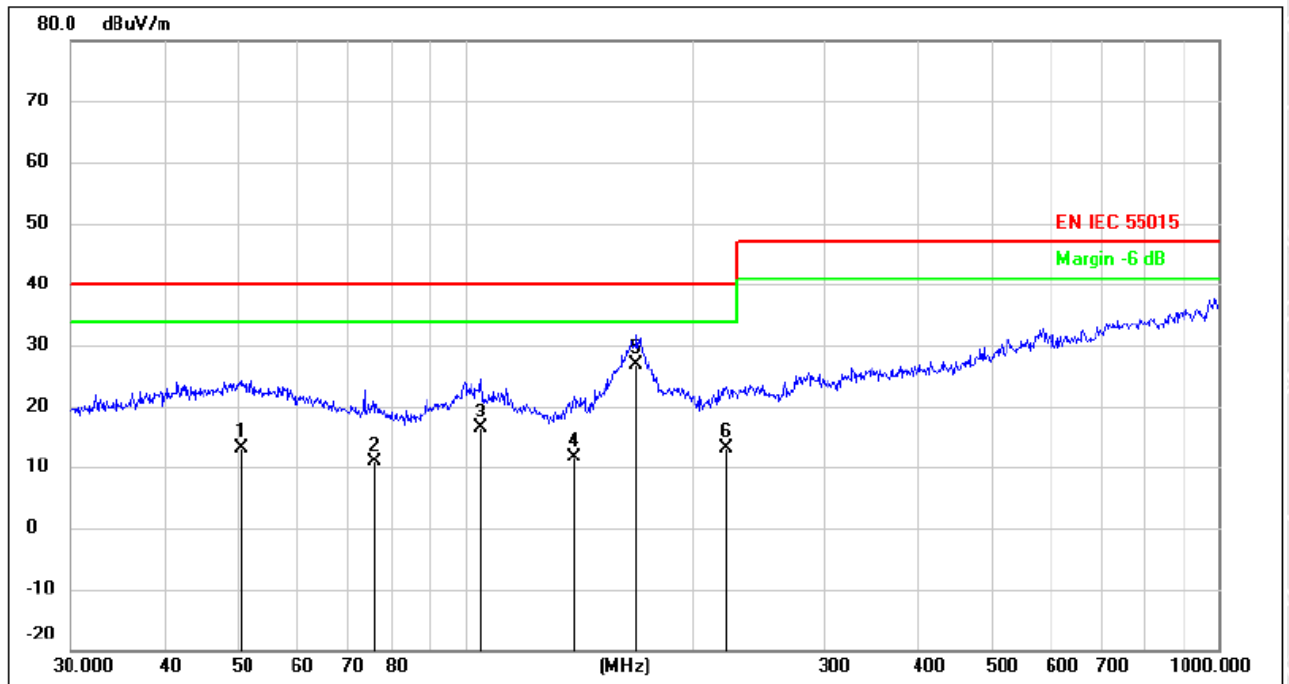

| No. | Frequency (MHz) | Reading (dBuV/m) | Correct dB/m | Result (dBuV/m) | Limit (dBuV/m) | Margin (dB) | Remark |
|-----|--------------------|---------------------|-----------------|--------------------|-------------------|----------------|--------|
| 1 | 50.5859 | -1.82 | 15.04 | 13.22 | 40.00 | -26.78 | QP |
| 2 | 75.4463 | 2.05 | 8.82 | 10.87 | 40.00 | -29.13 | QP |
| 3 | 105.2717 | 3.91 | 12.42 | 16.33 | 40.00 | -23.67 | QP |
| 4 | 139.8507 | 3.58 | 7.99 | 11.57 | 40.00 | -28.43 | QP |
| 5 | 168.7654 | 18.14 | 8.69 | 26.83 | 40.00 | -13.17 | QP |
| 6 | 222.1698 | 1.62 | 11.42 | 13.04 | 40.00 | -26.96 | QP |



5.4 Harmonics Current Emission

| | | |
|-----------------------|---|------------------|
| Test Requirement..... | : | EN IEC 61000-3-2 |
| Test Method..... | : | EN IEC 61000-3-2 |
| Test Result..... | : | Pass |
| Class/Severity..... | : | Class C |

5.4.1 E.U.T. Operation

Operating Environment:

| | | |
|-------------------|---|---------|
| Temperature | : | 24.8°C |
| Humidity..... | : | 59.8%RH |

EUT Operation:

| | | |
|---------------------|---|-------------|
| Input Voltage | : | 230V~, 50Hz |
| Operating Mode..... | : | On mode |

5.4.2 Block Diagram of Setup

The Harmonics Current emission test was performed in accordance with the EN IEC 61000-3-2.

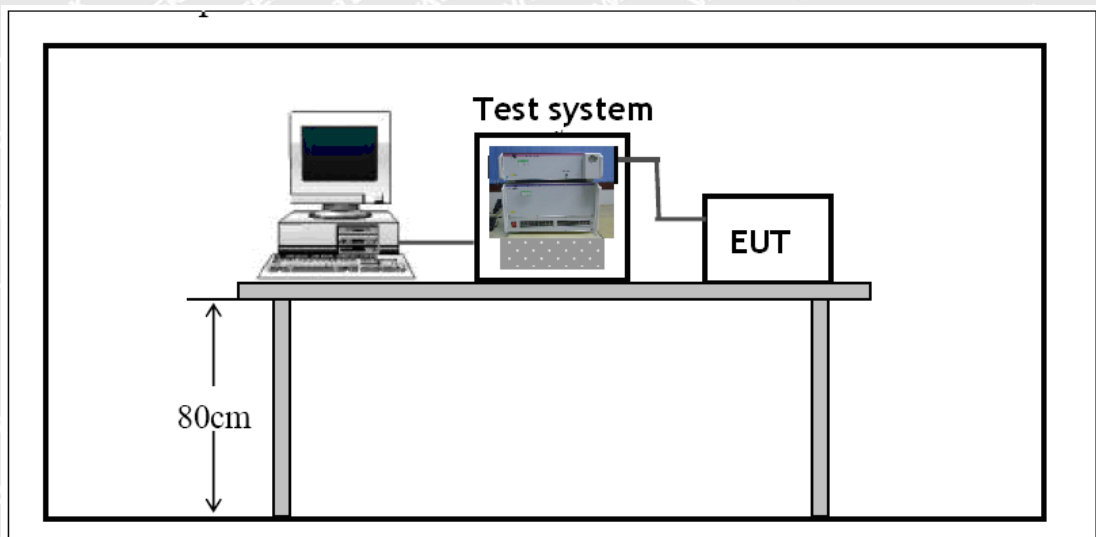



5.4.3 Harmonic Current Emission Test Data

| | | | |
|-------------------|-------------|---------------------|------------------------|
| Final Test Result | Pass | Tobs | Quasi-Stationary |
| Voltage | 230.04 V | THC | 0.0357 A |
| Current | 0.9363 A | POHC/Limit | 0.0173 A / 0.0888 A *3 |
| Power | 212.82 W | Nominal | 230 V / 50 Hz |
| Power Factor | 0.9880 | Fundamental Current | 0.9356 A |
| Apparent Power | 215.4 VA | Measuring Period | 150 s |
| THD (max) | 3.82 % | Margin | 100 % |

| Order | Limit1(A rms) | Limit2(A rms) | Ave(A rms) | Max(A rms) | Judge |
|-------|---------------|---------------|------------|------------|-------|
| 1 | ---- | ---- | 0.9340 | 0.9356 | N/A |
| 2 | 0.0187 | 0.0281 | 0.0006 | 0.0007 | N/A |
| 3 | 0.2773 | 0.4160 | 0.0120 | 0.0121 | Pass |
| 4 | ---- | ---- | 0.0002 | 0.0003 | N/A |
| 5 | 0.0936 | 0.1403 | 0.0080 | 0.0081 | Pass |
| 6 | ---- | ---- | 0.0001 | 0.0001 | N/A |
| 7 | 0.0655 | 0.0982 | 0.0060 | 0.0060 | Pass |
| 8 | ---- | ---- | 0.0001 | 0.0001 | N/A |
| 9 | 0.0468 | 0.0702 | 0.0080 | 0.0080 | Pass |
| 10 | ---- | ---- | 0.0001 | 0.0001 | N/A |
| 11 | 0.0281 | 0.0421 | 0.0102 | 0.0103 | Pass |
| 12 | ---- | ---- | 0.0001 | 0.0001 | N/A |
| 13 | 0.0281 | 0.0421 | 0.0116 | 0.0116 | Pass |
| 14 | ---- | ---- | 0.0001 | 0.0002 | N/A |
| 15 | 0.0281 | 0.0421 | 0.0124 | 0.0124 | Pass |
| 16 | ---- | ---- | 0.0001 | 0.0002 | N/A |
| 17 | 0.0281 | 0.0421 | 0.0123 | 0.0123 | Pass |
| 18 | ---- | ---- | 0.0002 | 0.0002 | N/A |
| 19 | 0.0281 | 0.0421 | 0.0110 | 0.0110 | Pass |
| 20 | ---- | ---- | 0.0002 | 0.0002 | N/A |
| 21 | 0.0421 | 0.0421 | 0.0099 | 0.0100 | Pass |
| 22 | ---- | ---- | 0.0002 | 0.0002 | N/A |
| 23 | 0.0421 | 0.0421 | 0.0084 | 0.0085 | Pass |
| 24 | ---- | ---- | 0.0002 | 0.0002 | N/A |
| 25 | 0.0421 | 0.0421 | 0.0072 | 0.0073 | Pass |
| 26 | ---- | ---- | 0.0002 | 0.0002 | N/A |
| 27 | 0.0421 | 0.0421 | 0.0055 | 0.0056 | Pass |
| 28 | ---- | ---- | 0.0002 | 0.0002 | N/A |
| 29 | 0.0421 | 0.0421 | 0.0042 | 0.0043 | N/A |
| 30 | ---- | ---- | 0.0002 | 0.0002 | N/A |
| 31 | 0.0421 | 0.0421 | 0.0035 | 0.0035 | N/A |
| 32 | ---- | ---- | 0.0002 | 0.0002 | N/A |
| 33 | 0.0421 | 0.0421 | 0.0025 | 0.0026 | N/A |
| 34 | ---- | ---- | 0.0002 | 0.0002 | N/A |
| 35 | 0.0421 | 0.0421 | 0.0020 | 0.0020 | N/A |
| 36 | ---- | ---- | 0.0002 | 0.0002 | N/A |
| 37 | 0.0421 | 0.0421 | 0.0017 | 0.0018 | N/A |
| 38 | ---- | ---- | 0.0002 | 0.0002 | N/A |
| 39 | 0.0421 | 0.0421 | 0.0015 | 0.0015 | N/A |
| 40 | ---- | ---- | 0.0002 | 0.0003 | N/A |

N/A : Not Apply



5.5 Voltage Changes, Voltage Fluctuation and Flicker

Test Requirement..... : EN 61000-3-3

Test Method..... : EN 61000-3-3

Test Result..... : Pass

According to EN 61000-3-3 which states: " Incandescent lamp luminaires with ratings less than or equal to 1000 W and discharge and LED lamp luminaires with ratings less than or equal to 600 W, are deemed to comply with the dc, dmax and Tmax limits in this standard and are not required to be tested. And LED luminaires with ratings less than or equal to 600 W, are deemed to comply with the dc, dmax and Tmax limits in this standard and are not required to be tested."

WALTEK



6 Immunity Test Results

6.1 Performance Criteria

Performance criterion A: During the test, no change of the luminous intensity shall be observed and the regulating control, if any, shall operate during the test as intended.

Performance criterion B: During the test, the luminous intensity may change to any value. After the test, the luminous intensity shall be restored to its initial value within 1 min. Regulating controls need not function during the test, but after the test, the mode of the control shall be the same as before the test provided that during the test no mode changing commands were given.

Performance criterion C: During and after the test, any change of the luminous intensity is allowed and the lamp(s) may be extinguished. After the test, within 30 min, all functions shall return to normal, if necessary by temporary interruption of the mains supply and/or operating the regulating control.

6.2 Electrostatic Discharge (ESD)

| | | |
|----------------------------------|---|---|
| Test Requirement | : | EN 61547 |
| Test Method | : | IEC 61000-4-2 |
| Test Result | : | Pass |
| Discharge Impedance | : | 330Ω / 150pF |
| Discharge Voltage | : | Air Discharge: ±8kV Contact Discharge: ±4kV HCP & VCP: ±4kV |
| Polarity | : | Positive & Negative |
| Number of Discharge | : | Minimum 10 times at each test point |
| Discharge Mode | : | Single Discharge |
| Discharge Period | : | 1 second minimum |

6.2.1 E.U.T. Operation

Operating Environment:

| | | |
|----------------------------------|---|----------|
| Temperature | : | 24.3°C |
| Humidity | : | 58.3%RH |
| Barometric Pressure | : | 100.8kPa |

EUT Operation:

| | | |
|-----------------------------|---|-------------|
| Input Voltage | : | 230V~, 50Hz |
| Operating Mode | : | On mode |



6.2.2 Block Diagram of Setup

The ESD test was performed in accordance with the IEC 61000-4-2.

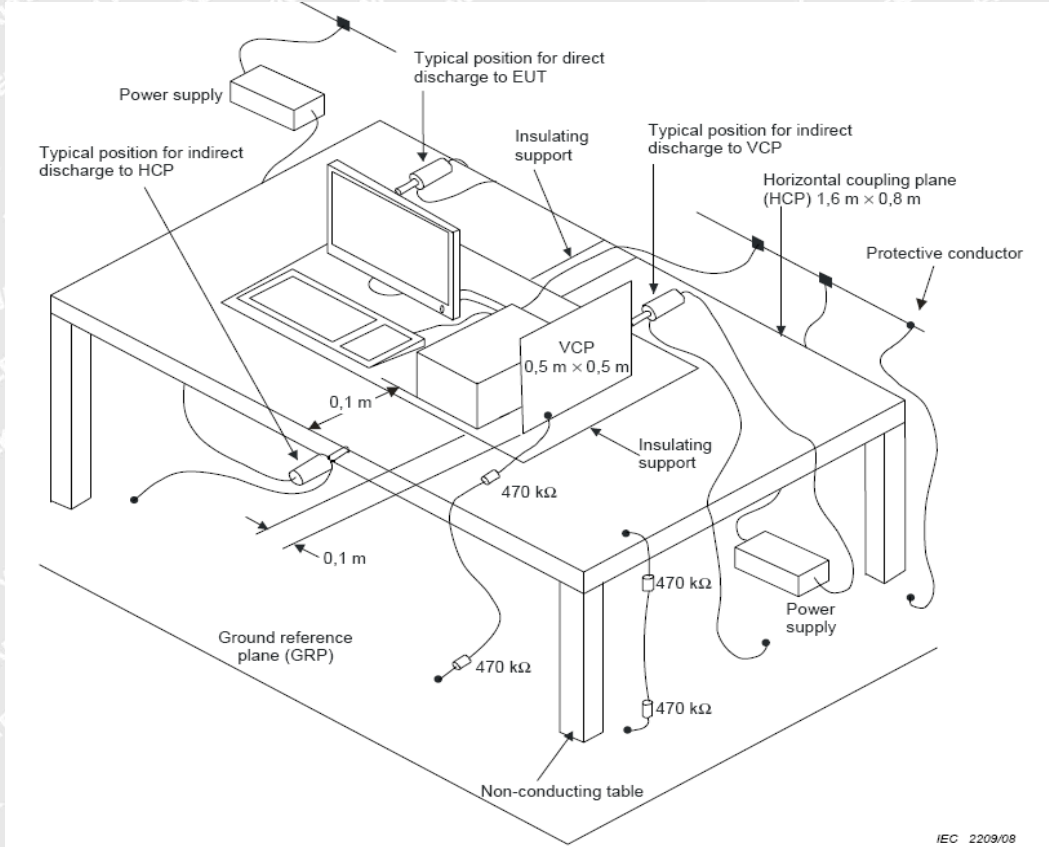

6.2.3 Direct Discharge Test Results

Observations: Test points: 1. All Exposed Surface & Seams;
 2. All metallic part

| Direct Discharge | | | Test Results | | |
|----------------------|-----------------------|------------|-------------------|---------------|--------------------|
| Applied Voltage (kV) | Performance Criterion | Test Point | Contact Discharge | Air Discharge | Actual performance |
| ±2, ±4, ±8 | B | 1 | N/A | Pass* | A |
| ±4 | B | 2 | Pass* | N/A | A |

Remark:

* During the test no deviation was detected to the selected operation mode(s)



6.2.4 Indirect Discharge Test Results

Observations:

Test points: 1. All sides.

| Indirect Discharge | | | Test Results | | |
|----------------------|-----------------------|------------|---------------------|-------------------|--------------------|
| Applied Voltage (kV) | Performance Criterion | Test Point | Horizontal Coupling | Vertical Coupling | Actual performance |
| ±4 | B | 1 | Pass* | Pass* | A |

Remark:

* During the test no deviation was detected to the selected operation mode(s)

6.3 Radio-frequency electromagnetic fields, 80MHz to 1GHz

Test Requirement..... : EN 61547

Test Method : IEC 61000-4-3

Test Result..... : Pass

Frequency Range : 80MHz to 1GHz

Test level..... : 3V/m

Modulation : 80%, 1kHz Amplitude Modulation.

Face of EUT : Front, Back, Left, Right

Antenna polarisation : Horizontal& Vertical

6.3.1 E.U.T. Operation

Operating Environment:

Temperature : 23.6°C

Humidity..... : 53.4%RH

EUT Operation:

Input Voltage : 230V~, 50Hz

Operating Mode..... : On mode



6.3.2 Block Diagram of Setup

The Radio-frequency electromagnetic fields Immunity test was performed in accordance with the IEC 61000-4-3.

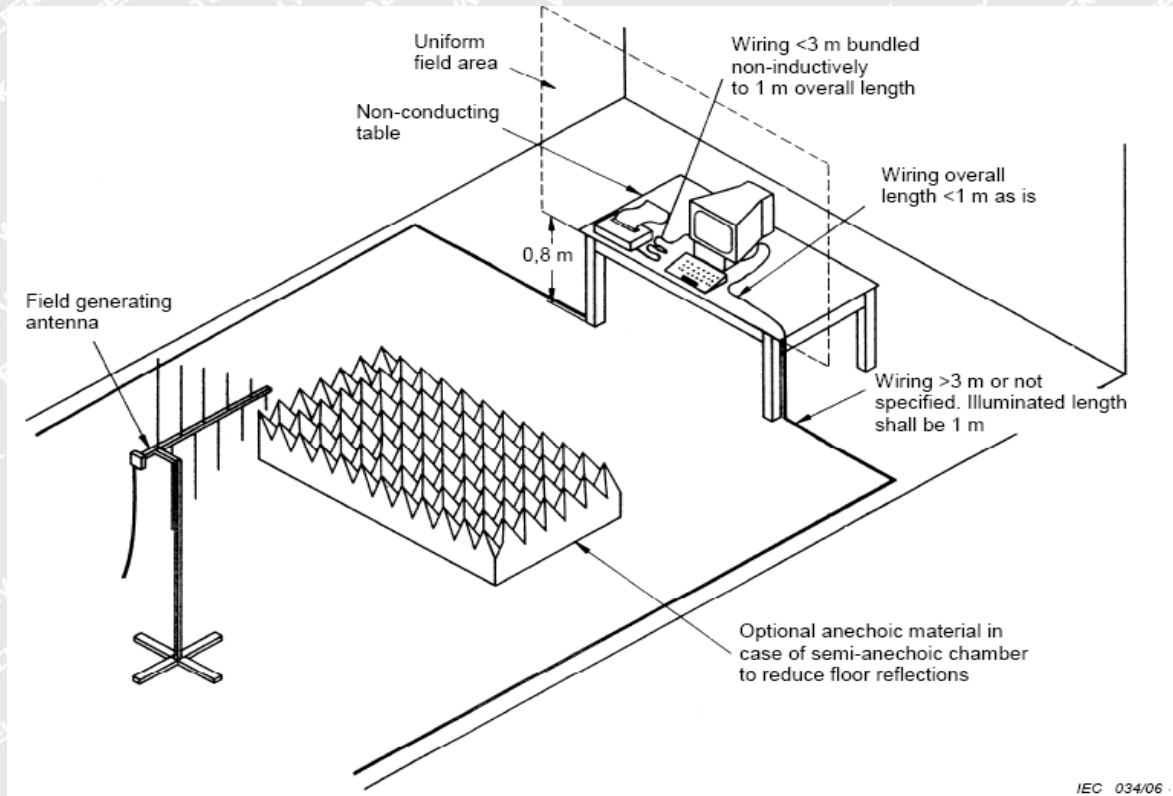

6.3.3 Test Results

| Frequency | Face of EUT | Antenna polarisation | Test Level | Step Size | Dwell Time | Performance Criterion | Result | Actual performance |
|---------------|--------------------------|----------------------|------------|-----------|------------|-----------------------|--------|--------------------|
| 80 to 1000MHz | Front, Back, Left, Right | Horizontal | 3V/m | 1% | 3s | A | Pass* | A |
| 80 to 1000MHz | Front, Back, Left, Right | Vertical | 3V/m | 1% | 3s | A | Pass* | A |

Remark:

* During the test no deviation was detected to the selected operation mode(s)



6.4 Electrical Fast Transients (EFT)

| | | |
|----------------------------------|---|--------------------------------|
| Test Requirement | : | EN 61547 |
| Test Method | : | IEC 61000-4-4 |
| Test Result | : | Pass |
| Test Level | : | 1.0kV on AC Mains |
| Polarity | : | Positive & Negative |
| Repetition Frequency | : | 5kHz |
| Burst Duration | : | 300ms |
| Test Duration | : | 2 minutes per level & polarity |

6.4.1 E.U.T. Operation

Operating Environment:

| | | |
|--------------------------|---|---------|
| Temperature | : | 24.3°C |
| Humidity | : | 58.3%RH |

EUT Operation:

| | | |
|-----------------------------|---|-------------|
| Input Voltage | : | 230V~, 50Hz |
| Operating Mode | : | On mode |

WALTEK



6.4.2 Block Diagram of Setup

The Electrical Fast Transients Immunity test was performed in accordance with the IEC 61000-4-4.

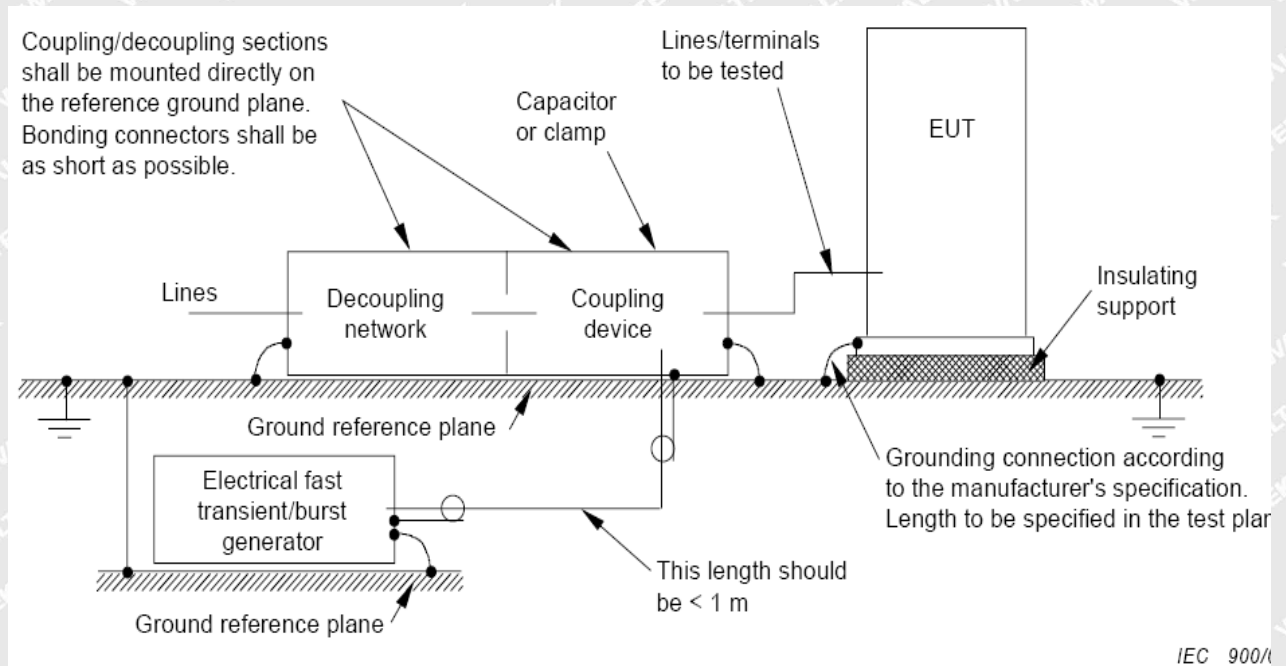

6.4.3 Test Results

| Test Port | Test Level(kV) | Performance Criterion | Result | Actual performance |
|-----------------|----------------|-----------------------|--------|--------------------|
| Line-Neutral-PE | ± 1.0 | B | Pass* | A |

Remark:

* During the test no deviation was detected to the selected operation mode(s)



6.5 Surge

| | |
|-----------------------|--|
| Test Requirement..... | : EN 61547 |
| Test Method..... | : IEC 61000-4-5 |
| Test Result..... | : Pass |
| Test level..... | : Table 10 of EN 61547 |
| Interval | : 60s between each surge |
| No. of surges | : 5 positive at 90°, 5 negative at 270°. |

6.5.1 E.U.T. Operation

Operating Environment:

| | |
|-------------------|-----------|
| Temperature | : 24.3°C |
| Humidity..... | : 58.3%RH |

EUT Operation:

| | |
|---------------------|---------------|
| Input Voltage | : 230V~, 50Hz |
| Operating Mode..... | : On mode |

6.5.2 Block Diagram of Setup

The Surge Immunity test was performed in accordance with the IEC 61000-4-5.

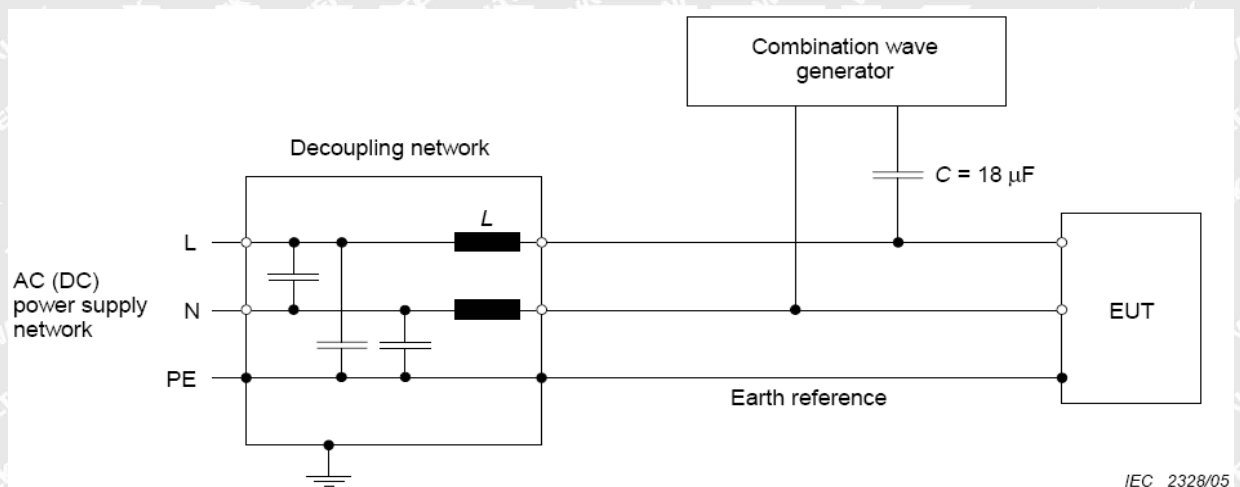

6.5.3 Test Results

| Test Port | Applied Voltage (kV) | Performance criterion | Result | Actual performance |
|----------------------------|----------------------|-----------------------|--------|--------------------|
| Between Live And Neutral | ±1 | C | Pass* | A |
| Between Live And Ground | ±2 | C | Pass* | A |
| Between Neutral And Ground | ±2 | C | Pass* | A |

Remark:

Waltek Testing Group (Ningbo) Co., Ltd.
<http://www.waltek.com.cn>



* During the test no deviation was detected to the selected operation mode(s)

6.6 Injected Currents Immunity 0.15MHz to 80MHz

| | | |
|-------------------------------|---|--|
| Test Requirement | : | EN 61547 |
| Test Method | : | IEC 61000-4-6 |
| Test Result | : | Pass |
| Frequency Range | : | 0.15MHz to 80MHz |
| Test level | : | 3V r.m.s. (unmodulated emf into 150 Ω) |
| Modulation | : | 80%, 1kHz Amplitude Modulation. |

6.6.1 E.U.T. Operation

Operating Environment:

| | | |
|--------------------------|---|---------|
| Temperature | : | 24.3°C |
| Humidity | : | 57.4%RH |

EUT Operation:

| | | |
|-----------------------------|---|-------------|
| Input Voltage | : | 230V~, 50Hz |
| Operating Mode | : | On mode |

6.6.2 Block Diagram of Setup

The Injected Currents Immunity test was performed in accordance with the IEC 61000-4-6.

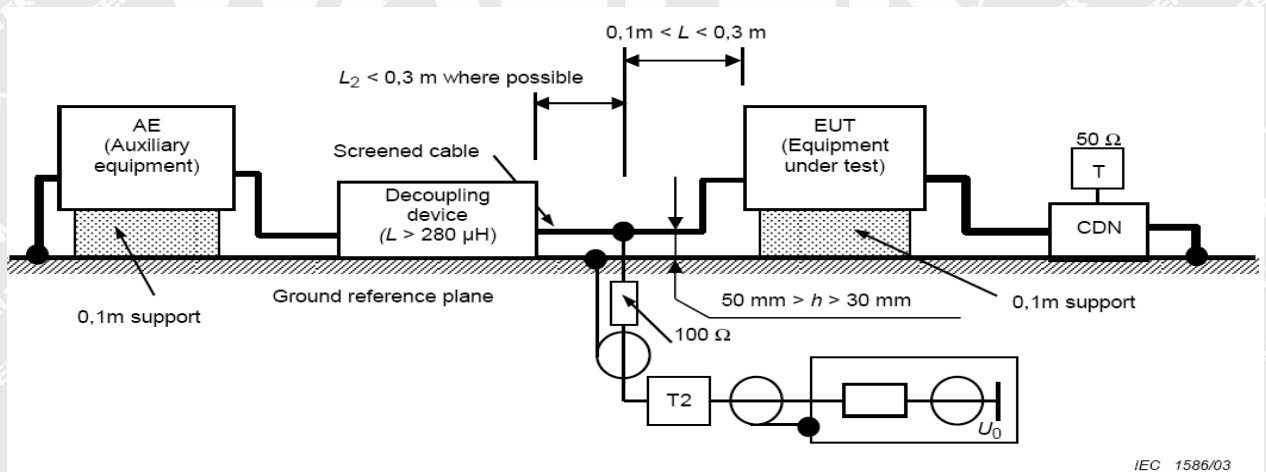

IEC 1586/03

6.6.3 Test Results

| Frequency | Line | Test Level | Modulation | Step Size | Dwell Time | Performance Criterion | Result | Actual performance |
|------------------|-------------------------|------------|---------------------|-----------|------------|-----------------------|--------|--------------------|
| 0.15MHz to 80MHz | 3 Wire AC Supply Cables | 3Vr.m.s. | 80%, 1kHz Amp. Mod. | 1% | 3s | A | Pass* | A |

Remark:
Waltek Testing Group (Ningbo) Co., Ltd.
<http://www.waltek.com.cn>



* During the test no deviation was detected to the selected operation mode(s)

WALTEK



6.7 Voltage Dips and Interruptions

| | |
|----------------------------------|-----------------------------------|
| Test Requirement..... | EN 61547 |
| Test Method..... | IEC 61000-4-11 |
| Test Result..... | Pass |
| Test Level(Voltage reduction) | 0%&70 % of U_T (Supply Voltage) |
| No. of Dips / Interruptions..... | 1 per Level at 20ms intervals |

6.7.1 E.U.T. Operation

Operating Environment:

| | |
|-------------------|---------|
| Temperature | 24.3°C |
| Humidity | 58.3%RH |

EUT Operation:

| | |
|---------------------|-------------|
| Input Voltage | 230V~, 50Hz |
| Operating Mode..... | On mode |

6.7.2 Block Diagram of Setup

The Voltage Dips and Interruptions Immunity test was performed in accordance with the IEC 61000-4-11.

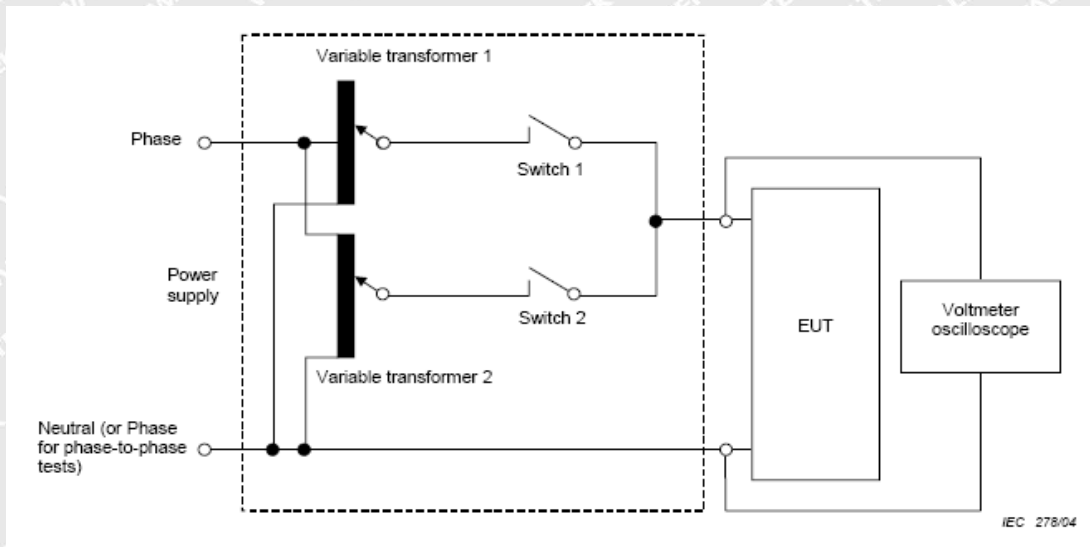

6.7.3 Test Results

| Test Level in % U_T | Phase | Performance criterion | Duration | Result | Actual performance |
|-----------------------|-----------|-----------------------|----------|--------|--------------------|
| 0 | 0° & 180° | B | 0.5 | Pass* | A |
| 70 | 0° & 180° | C | 10 | Pass* | A |

Remark:

* During the test no deviation was detected to the selected operation mode(s)



7 Photographs – Test Setup

7.1 Photograph – Mains Terminal Disturbance Voltage Test Setup

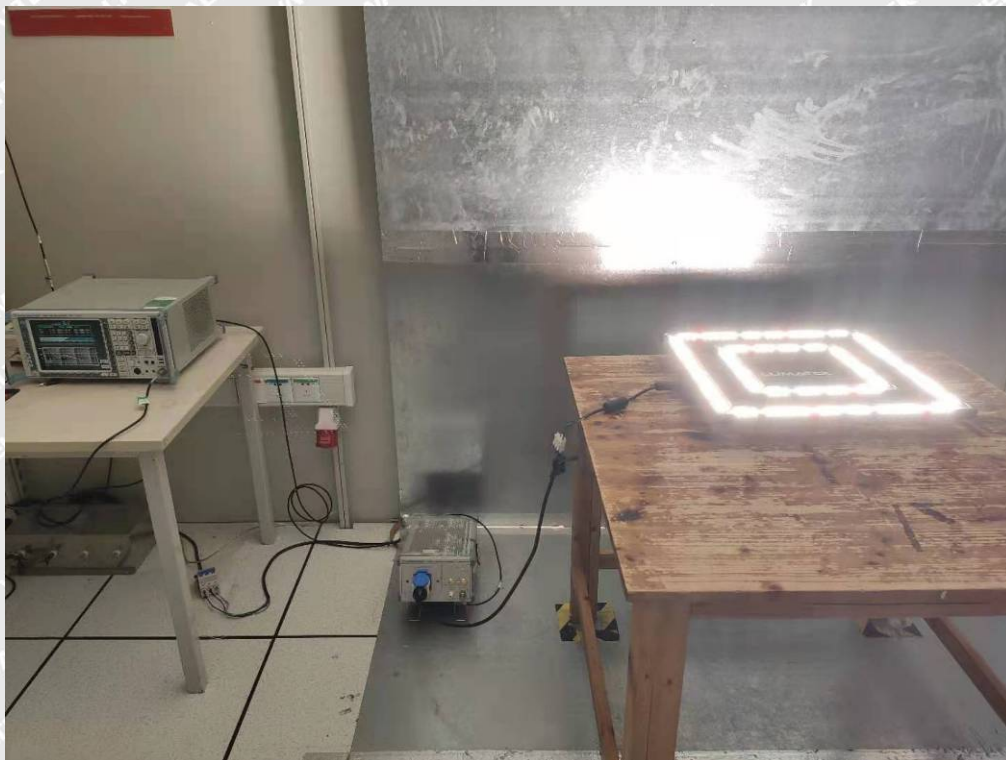

7.2 Photograph – Radiated electromagnetic disturbance Test Setup, 9kHz to 30MHz





7.3 Photograph – Radiated Emission Test Setup, 30MHz to 1GHz



7.4 Photograph – Harmonic Current and Flicker Test Setup





7.5 Photograph – ESD Immunity Test Setup

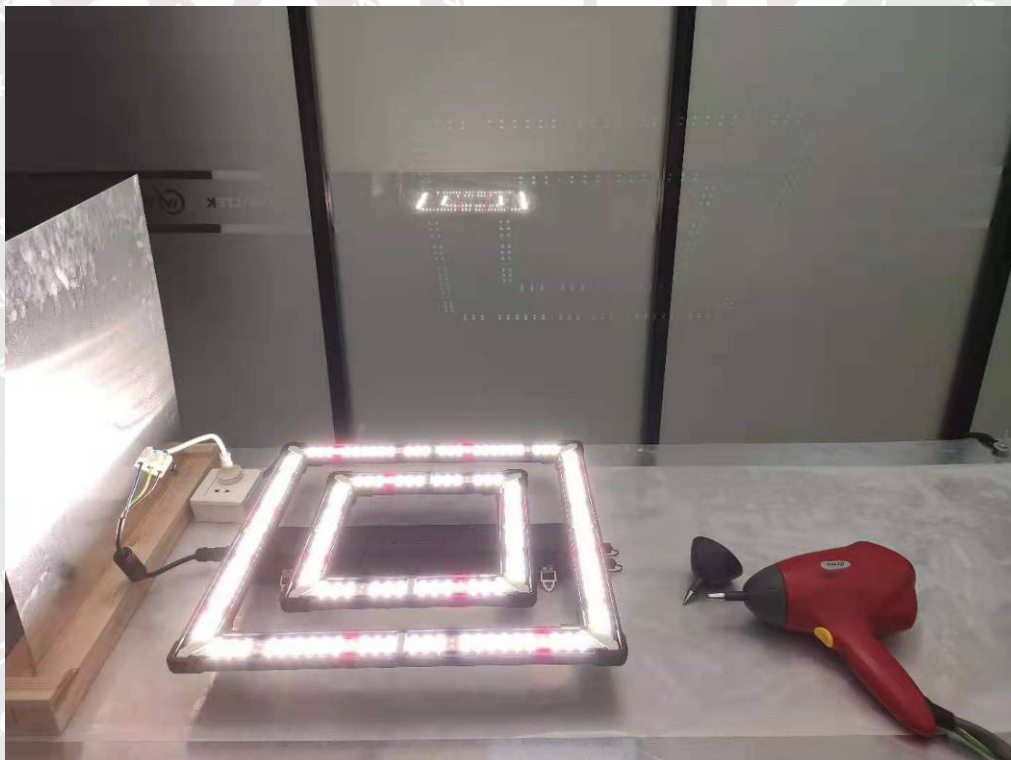

7.6 Photograph – Radio-frequency electromagnetic fields Immunity Test Setup



7.7 Photograph – EFT & Voltage Dips and Interruptions Immunity Test Setup

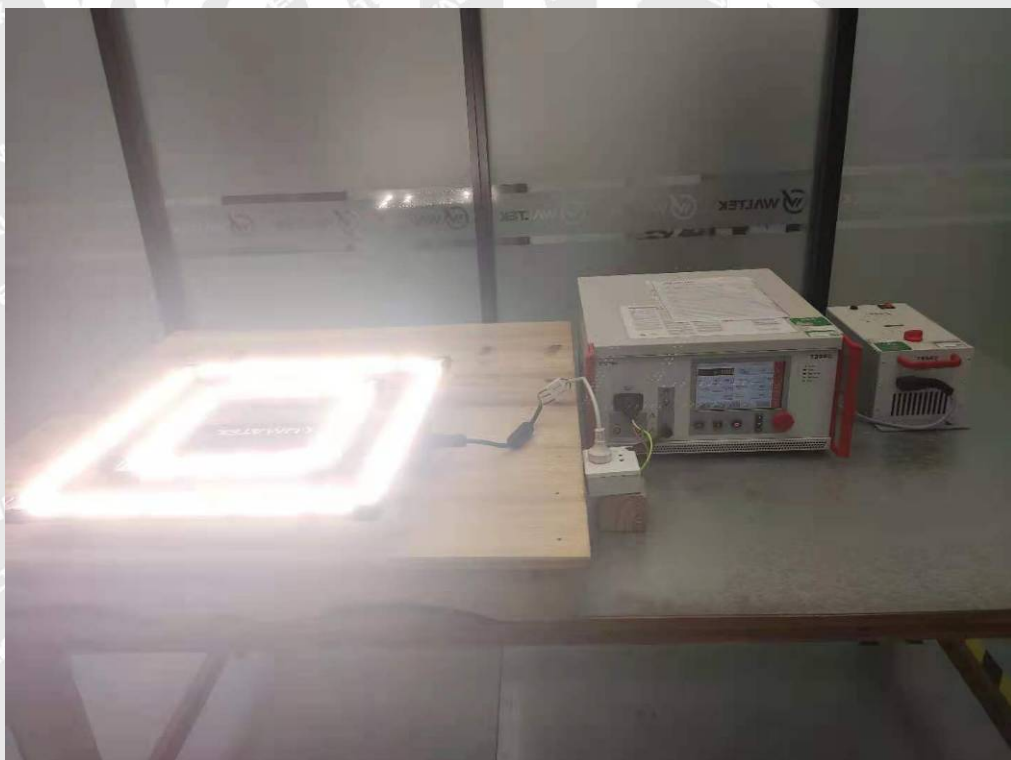

7.8 Photograph – Surge Immunity Test Setup

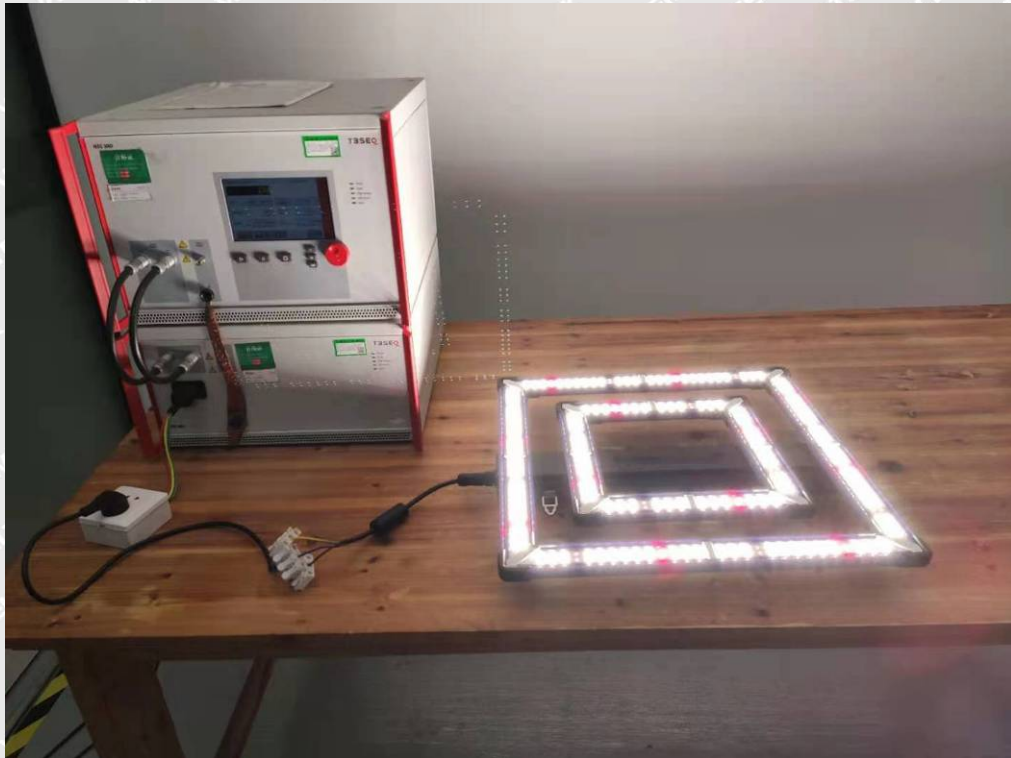

7.9 Photograph – Injected Currents Immunity Test Setup





WALTEK

8 Photographs – Constructional Details

8.1 EUT – Front View

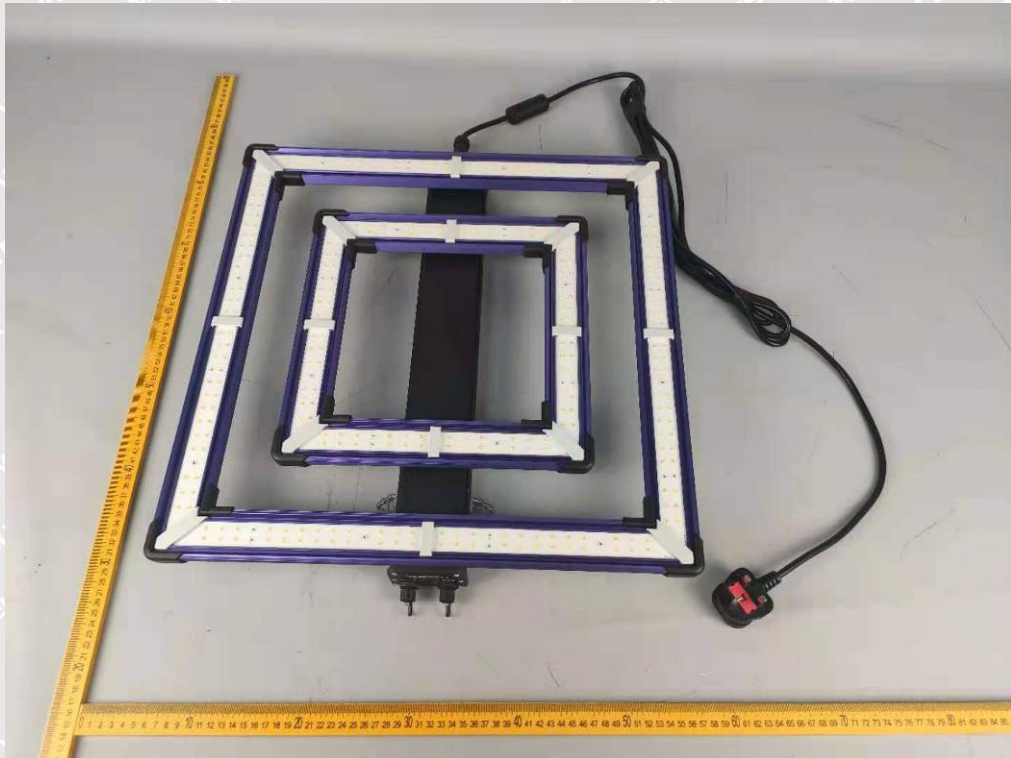

8.2 EUT – Back View

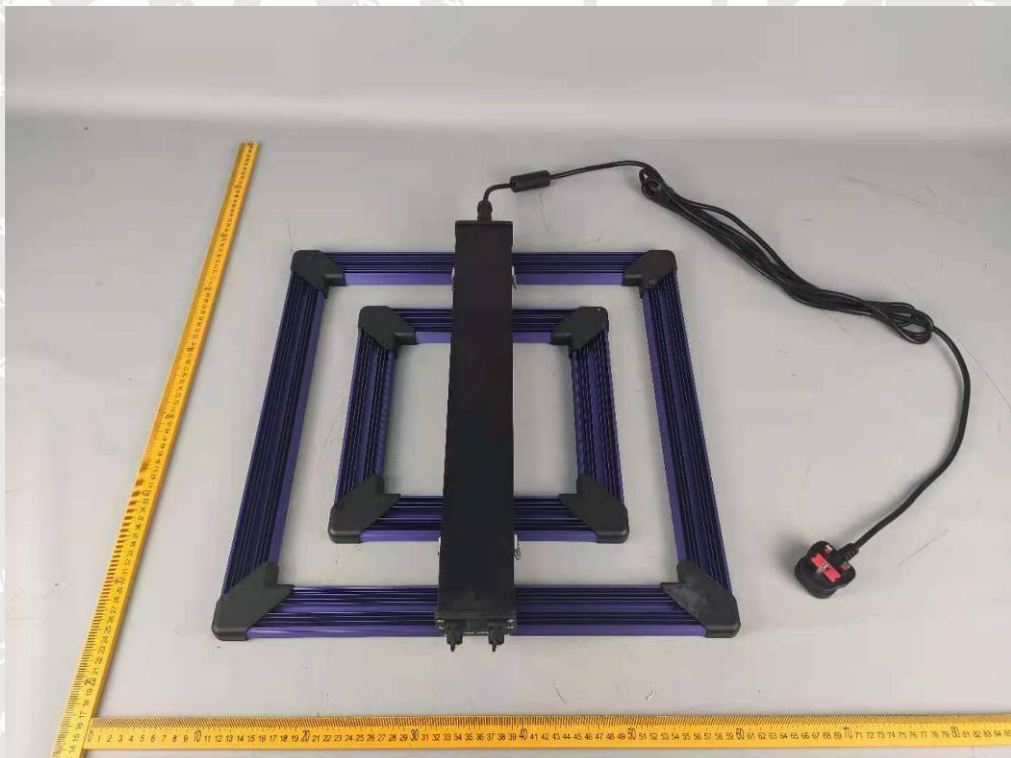

====End of Report====