



portier

LIMITLESS BABY CARRIER

INSTRUCTIONS: SAFETY & CARE

CARRY YOUR BABY SAFELY

IMPORTANT! READ ALL INSTRUCTIONS CAREFULLY BEFORE USING THE CARRIER & KEEP INSTRUCTIONS FOR FUTURE REFERENCE AND USE.

WARNING: FALL AND SUFFOCATION HAZARD

FALL HAZARD -

INFANTS CAN FALL THROUGH A WIDE LEG OPENING OR OUT OF CARRIER.

- Adjust leg openings to fit child's legs snugly.
- Before each use, make sure all fasteners are secure.
- Take special care when leaning or walking.
- Never bend at waist; bend at knees.
- Child must face towards you until they can hold their head upright.
- Only use this carrier for children between 7 lbs. And 35 lbs. (3.2kg-16kg).
- DO NOT USE for a child weighing less than 7lbs (3.2kg).
- DO NOT let child sleep in outward facing position.
- DO NOT USE this carrier during sporting activities.

SUFFOCATION HAZARD -

INFANTS UNDER 4 MONTHS CAN SUFFOCATE IN THIS PRODUCT IF FACE IS PRESSED TIGHT AGAINST YOUR BODY.

- Do not strap infant too tight against your body.
- Allow room for head movement.
- Keep infant's face free from obstruction at all times.

WARNING -

- When using this carrier, constantly monitor your child and ensure that their mouth and nose are unobstructed.
- For low birth weight babies and children with medical conditions, seek advice from a health professional before using this product.
- Check for ripped seams, loose buttons, torn straps, and adjustments are secure before each use.
- STOP using the carrier if parts are missing or damaged.
- Ensure correct placement of child in the carrier, including leg placement.
- Never use carrier when balance or mobility is impaired due to exercise, drowsiness or medical conditions.
- Never wear a carrier while driving or being a passenger in a motor vehicle
- Keep this carrier away from children when not in use.

PRECAUTIONS FOR USE OF PORTIER LIMITLESS CARRIER –

Read all instructions before assembling and using the soft carrier. Practice putting on your Carrier before using.

Never use this product when balance or mobility is impaired because of exercise, drowsiness, or medical conditions. Never use this product while engaging in activities such as cooking and cleaning which involve a heat source or exposure to chemicals. Never wear a soft carrier while driving or being a passenger in a vehicle. Be careful when drinking hot beverage to avoid spilling hot drinks onto the baby while using the carrier. Never remove the waistbelt, until your child is removed from the carrier. As a baby becomes more active, there is an increased risk of the child falling out of the carrier. Never carry more than one child at a time.

Baby's chin should NEVER rest on baby's chest because this partially closes baby's airway. There should always be at least two fingers width clearance beneath baby's chin. Wearer must be sure that baby's airway is clear and that baby is breathing normally at ALL TIMES. Premature infants, infants with respiratory problems, and infants under 4 months are at greatest risk of suffocation. Avoid dressing your child too warmly.

Ensure proper placement of baby in product including leg placement. The baby's position should be checked regularly to make sure that the baby is comfortable and properly seated in the Carrier, centered with legs extended and head upright and not slumping downward or to the side. Baby's arms, legs and feet need to be observed regularly while in the Carrier to ensure that they are not constricted. The carrier must be worn in a way that allows for a baby to move their head without their face being pressed tight against your body. Ensure that baby's fingers are not caught in a buckle as this may cause injury to the baby. Always fasten the buckles properly when the carrier is not in use. Keep the carrier away from children when it is not in use.

Check to assure all buckles, snaps, straps and adjustments are secure before each use. Regularly inspect the carrier for any sign of wear and damage. Stop using the carrier if parts are missing or damaged in any way. Check for ripped seams, torn straps or fabrics and damaged fasteners before each use. Regularly check straps and buckles while in use to make sure they have proper tension and placement. Regularly check that your child is securely seated in baby carrier, especially when using the back carry function. This baby carrier is intended for use by adults only.

For any assistance required on how to use the carrier safely and comfortably, please send an email to info@portier.com.au or refer to our video or image instructions, www.portier.com.au.

The references to ages are only a general guide. Each baby is different. This carrier is not to be used with any babies less than 3.2kg/7lbs and less than 50cm tall.

CONTENTS

WARNING STATEMENTS	2
ABOUT PORTIER	8
INSTRUCTIONS FOR USE	9
HOW TO ADJUST THE LIMITLESS CARRIER	10
SECURING THE WAIST BELT	14
FRONT CARRY - FACING IN	15
FRONT CARRY - FACING OUT	21
BACK CARRY	27
WASH & CARE	33
DISCLAIMER	34

Connect with the portier posse



ABOUT PORTIER

OUR STORY

Portier was born from the desire to give parents the confidence to style parenthood their way.

As a lover of contemporary design, portier's founder struggled to find products that accurately reflected her approach to style and motherhood. It was an experience that ultimately formed the foundation for portier's bold mission: to make the intimidating, daunting and confusing world of baby products not just approachable, but conquerable.

Australian owned and determined to redefine baby essentials for a modern era, portier are committed to creating products that don't compromise on aesthetics or functionality.

Embodying our bold vision of parenthood, our hero product, the Limitless Carrier, gives parents the freedom to lean into their new lifestyle, without limitation.

With a forward looking, empowered vision of parenthood, we instinctively want the best for our children — both at home and in the big wide world.

From palette to print, fabric to fit, we are committed to uncompromising detail, sustainable manufacturing practices and durable, premium textiles that are as gentle for families as they are the planet.

More than anything, portier are passionate believers that parenthood looks strikingly different for everyone. And that every parent should be celebrated.

FOR THE LIMITLESS BABY CARRIER

HOW TO ADJUST THE LIMITLESS BABY CARRIER TO YOUR BABY'S NEEDS

WIDTH:

The bottom of the carrier's waist belt, which is where the baby will sit, has 3 sizing positions to suit the length and weight of your baby.

Different sizes can be created by adjusting the position of the snap buttons found on the inside of the waist belt of the carrier.

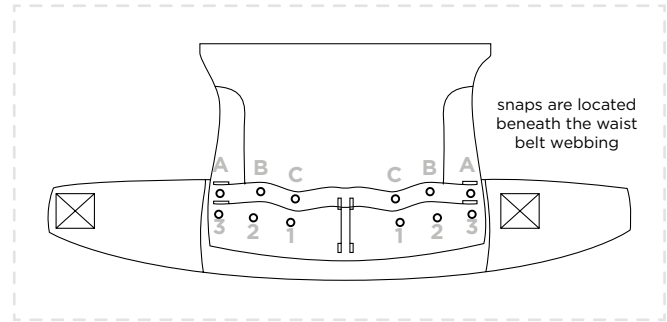

SUITABLE FROM BIRTH - 3 MONTHS

The narrowest setting can be used for babies with a minimum weight of 3.2kg

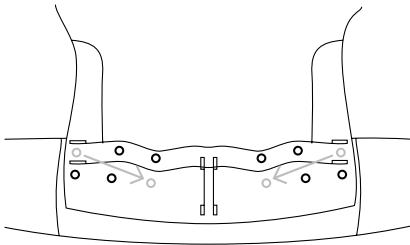

Secure snap A to snap 1.

SUITABLE FROM 3-9 MONTHS

The middle setting can be used with babies 3-9 months.

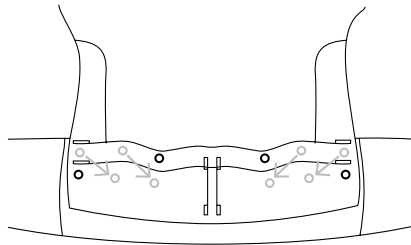

Secure snap A to snap 2 and snap B to snap 1

SUITABLE FROM 9 MONTHS

The widest setting is suitable for babies from 9 months until a maximum weight of 35lbs (16kg).

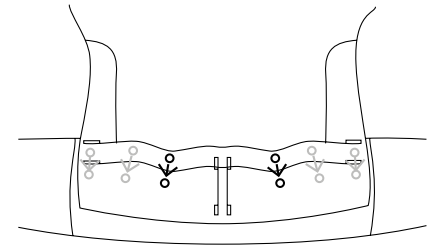

Secure snap A to snap 3, snap B to snap 2, Snap C to snap 1.

FINDING THE CORRECT FIT FOR YOUR BABY

IN ALL CARRIER POSITIONS, YOUR BABY'S KNEES SHOULD ALWAYS BE HIGHER THAN THEIR BOTTOM, FABRIC SUPPORTING THE THIGHS.

CORRECT POSITIONING - INWARD FACING

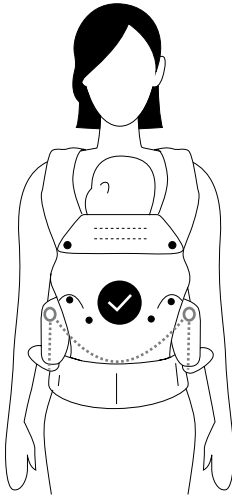

"M" POSITION

The "M" Position is the ergonomically correct position.

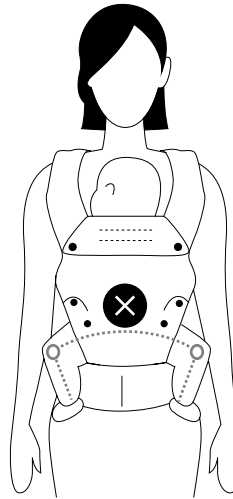

TOO NARROW FOR YOUR BABY'S FIT

When your baby's thighs are not fully supported, the carrier should be adjusted to a wider setting.

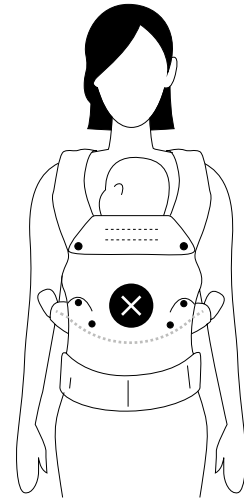

TOO WIDE FOR YOUR BABY'S FIT

When the fabric reaches beyond your baby's knees, the carrier should be adjusted to a narrower setting.

HOW TO ADJUST THE LIMITLESS BABY CARRIER TO YOUR BABY'S NEEDS

CORRECT POSITIONING - OUTWARD FACING

- 1 Proper carrier setup is important to achieve an ergonomic carrying position when a child is facing out in the Limitless carrier.
- 2 Be sure the seat is adjusted to the widest setting whenever carrying a child in the facing out position.
- 3 Fasten the buttonholes on the outside thigh support to the lower set of buttons on the front of the carrier panel, to widen the leg opening.
- 4 The neck support pillow should always be fastened into place on the outside of the carrier in the facing out position.

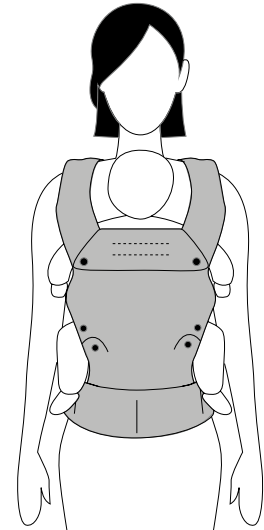
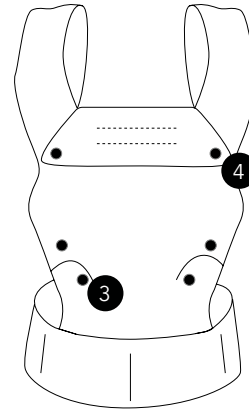

HOW TO ADJUST THE NECK CUSHION TO YOUR BABY'S SIZE AND NEEDS:

The neck cushion of the carrier is also adjustable in height. There are two height positions – short and Tall.

- 1 **Short position:** Secure the neck support to the outside of the panel using the button located on the outside edge of the carrier.
- 2 **Tall position:** Secure the neck support to the inside of the shoulder straps by snapping the neck support in the upwards position into the snaps on the inside of the shoulder straps.

- 3 **Correct positioning of neck cushion:** When determining which panel height to use with your child, always choose a height that allows child's face to be visible over the top edge of the panel.

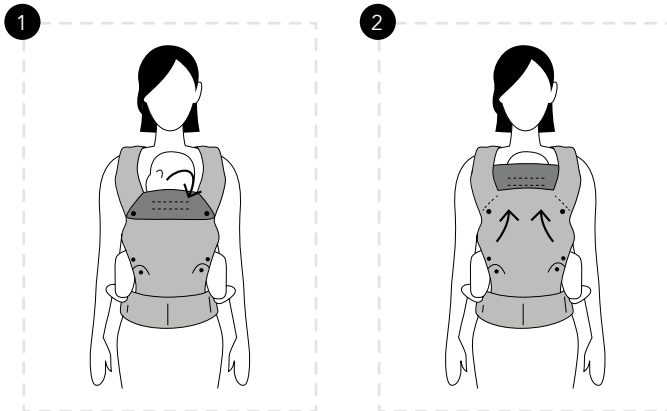

3

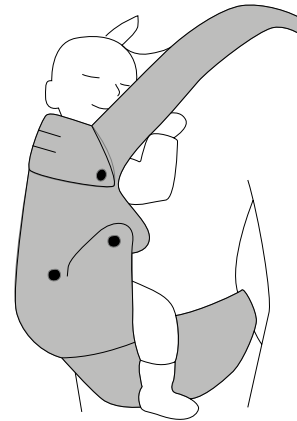

SECURING THE LIMITLESS WAIST BELT

- 1 Position the waist belt around you with the labels facing inwards, towards your body.
- 2 Start with the waist belt around your natural waist, adjust up or down slightly to your comfort.

- 3 Feed the buckle under the elastic strap until you hear a click.
- 4 Tighten the waist belt by pulling until it lays flat against your body, with no gaps or looseness.

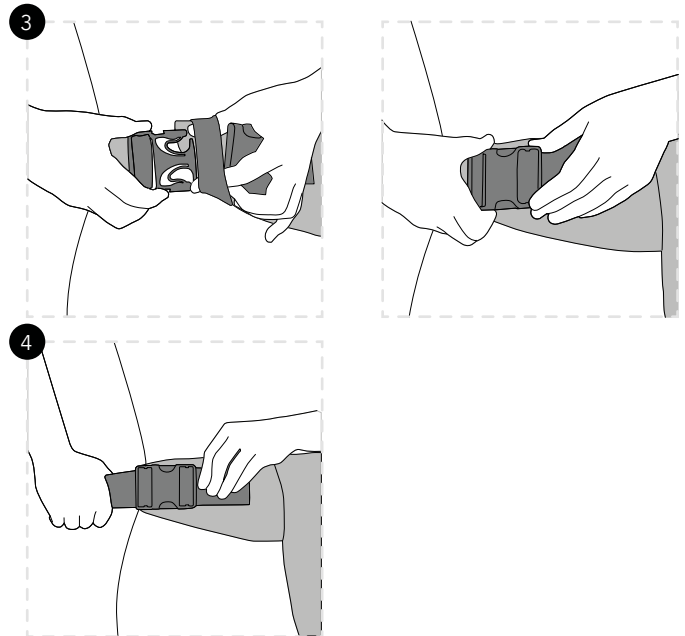
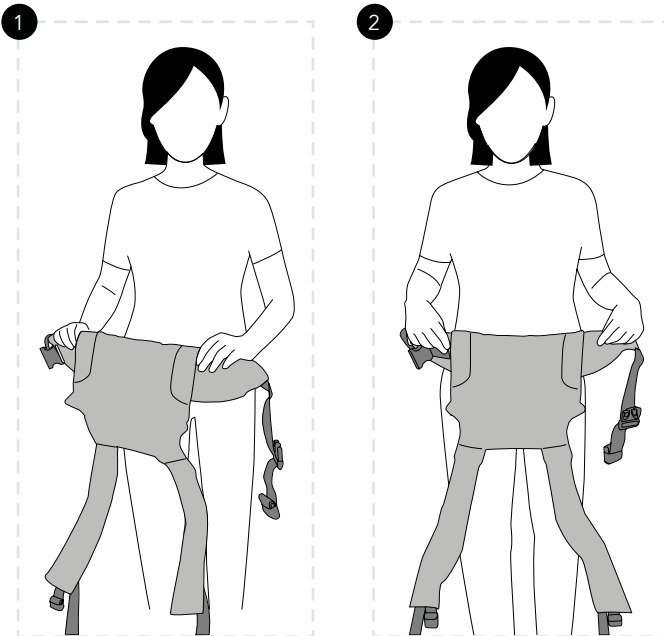

FRONT CARRY - BABY FACING INWARD

BIRTH 7LBS/3.2KG - 35LBS/16KG

FRONT CARRY – BABY FACING INWARD

IMPORTANT:

- THIGH SUPPORT SHOULD ALWAYS BE BUTTONED ONTO THE TOP MOST OUTER PANEL BUTTON WHEN CARRYING A BABY FACING IN.
- PLEASE ENSURE THE CARRIER IS SET UP TO APPROPRIATE WIDTH FOR YOUR CHILD'S SIZE – REFER TO PAGE 10.

- 1 Position the waist belt so that the panel is centred on the front of your body.
- 2 Ensure that before beginning, the shoulder straps are adjusted to their full length and buckles are unfastened. Lift the body panel up by placing the right shoulder strap on your right shoulder.
- 3 Pull the right shoulder strap across your back.
- 4 Feed the buckle of the right shoulder strap into the buckle on the left side of the body panel until it clicks.

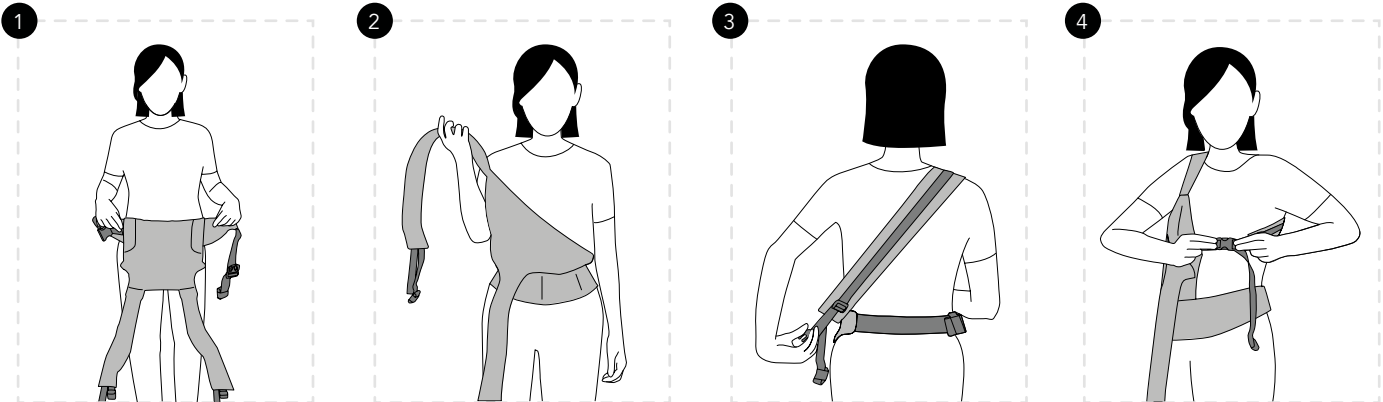

FRONT CARRY - BABY FACING INWARD CONTINUED

- 5 Pick up your child and with your left hand position them facing inwards, while using the other hand to slip the child's leg between the panel and your body.
- 6 Use your right hand to support your child, while using the other hand to slip the child's right leg underneath the strap already buckled into the side of the body panel.
- 7 Pull the left shoulder strap, lifting the body panel behind your child's back and over your left shoulder.
- 8 Pull the left shoulder strap across your back.

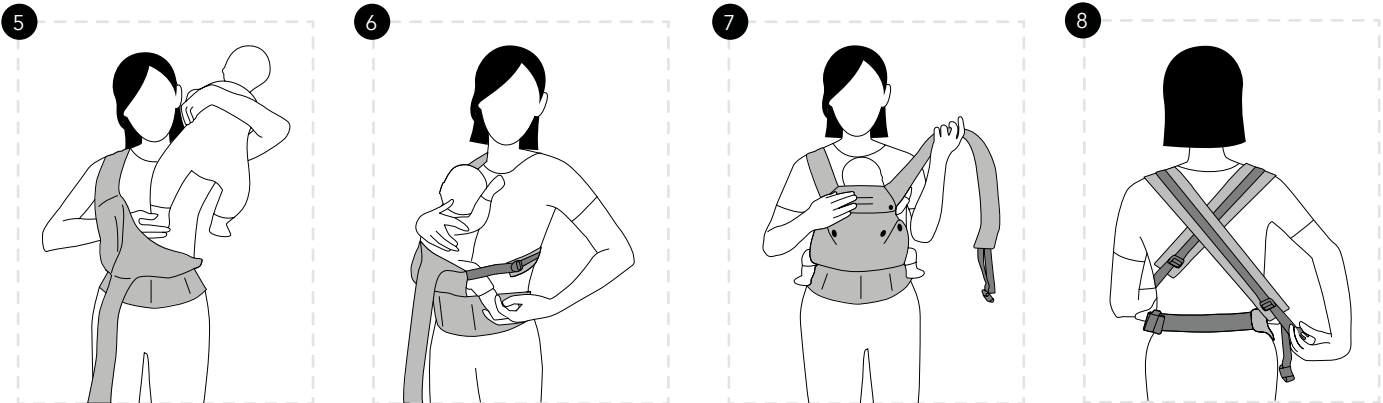

FRONT CARRY - BABY FACING INWARD CONTINUED

9 Tighten both side straps simultaneously by pulling. Make sure your child is comfortable and not too tight against your body. Allow room for the child's head movement.

10 Ensure your child's bottom is seated deeply in the carrier's body panel just above the waist belt by gently pushing up on the baby's calves. Baby should be seated in the "M" shaped position. Refer to page 11.

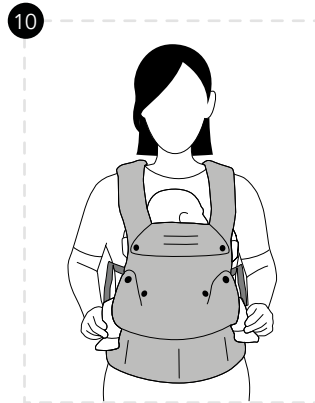
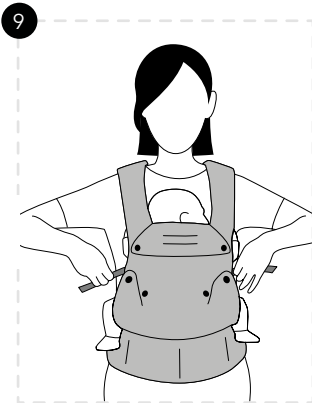

TO REMOVE YOUR CHILD FROM THE CARRIER:

IMPORTANT:

- DO NOT REMOVE THE WAIST BELT, UNTIL YOUR CHILD IS REMOVED FROM THE CARRIER.

- 1 While holding with one hand the bottom of your child, use your other hand to unbuckle one of the shoulder straps.
- 2 Now use your other hand to hold the child and pull the loose shoulder strap behind the child's back.
- 3 While holding your child with one hand, unbuckle the other strap.
- 4 Bring the loose straps behind the child's back while always holding your child with one hand.
- 5 Your child is now OK to be removed from the carrier.

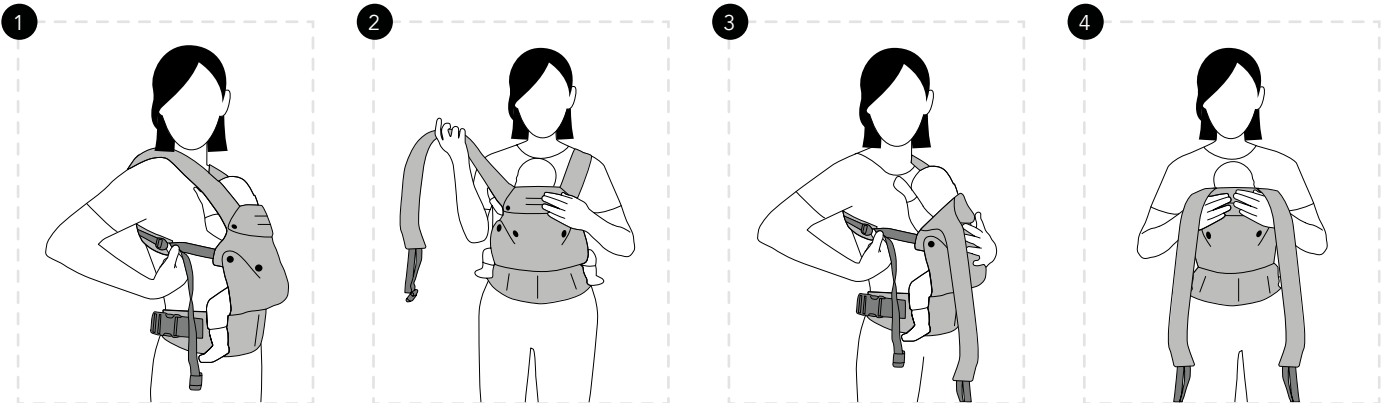

FRONT CARRY - BABY FACING OUTWARD

13LBS/5.9KG - 22LBS/10KG

FRONT CARRY - BABY FACING OUTWARD

IMPORTANT:

- THIGH SUPPORT SHOULD ALWAYS BE BUTTONED ONTO THE LOWER SET OF BUTTONS ON THE FRONT CARRIER PANEL WHEN CARRYING A BABY FACING OUTWARD.
- BE SURE THE SEAT IS ADJUSTED TO THE WIDEST SETTING (PAGE 10) WHENEVER CARRYING A CHILD IN THE FACING OUTWARD POSITION.

WARNING DO NOT LET BABY SLEEP IN THE FACING-OUT POSITION

- 1 Position the waist belt so that the panel is centred on the front of your body.
- 2 Ensure that before beginning, the shoulder straps are adjusted to their full length and buckles are unfastened. Lift the body panel up by placing the right shoulder strap on your right shoulder.

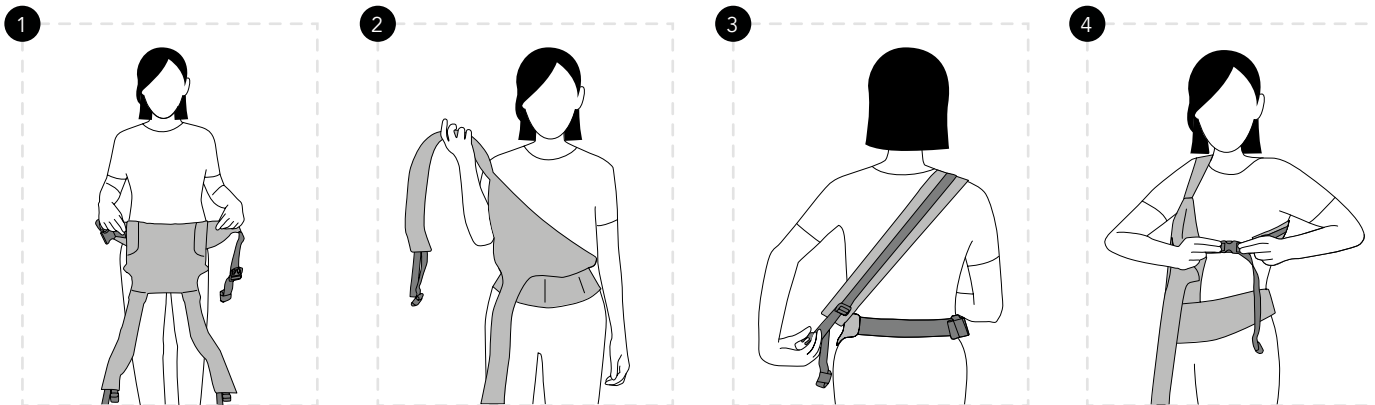

FRONT CARRY - BABY FACING OUTWARD CONTINUED

- 3 Pull the right shoulder strap across your back.
- 4 Feed the buckle of the right shoulder strap into the buckle on the left side of the body panel until it clicks.
- 5 Pick up your child and with your left hand position them facing outwards, while using the other hand to slip the child's left leg between the panel and your body.

- 6 Use your right hand to support your child, while using the other hand to slip the child's right leg underneath the strap already buckled into the side of the body panel.
- 7 Pull the left shoulder strap, lifting the body panel behind your child's back and over your left shoulder.
- 8 Pull the left shoulder strap across your back.

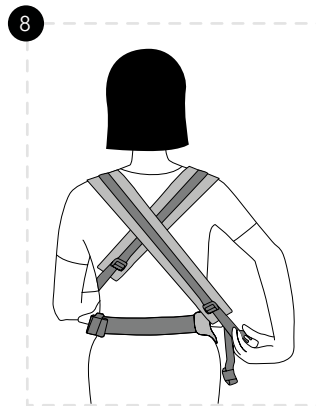
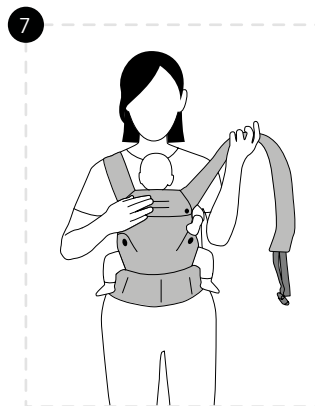
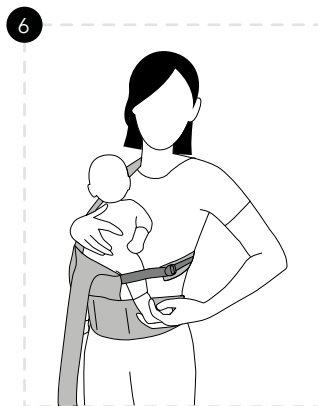
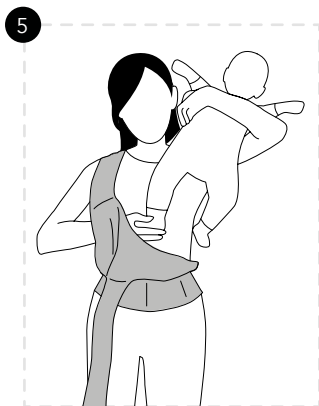

FRONT CARRY - BABY FACING OUTWARD CONTINUED

- 9 Tighten both side straps simultaneously. Make sure your child is comfortable. Child's arms should be positioned between the under-arm webbing and should strap straps so they can move freely.

- 10 Ensure that your child is comfortably positioned, by pivoting their pelvis forward and pulling the seat under their thighs.

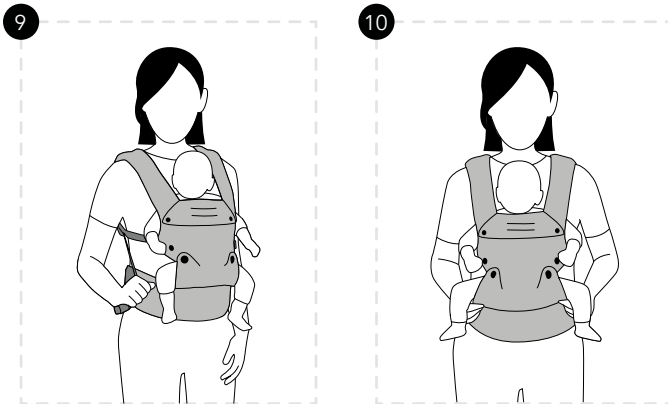

TO REMOVE YOUR CHILD FROM THE CARRIER:

IMPORTANT:

- DO NOT REMOVE THE WAIST BELT, UNTIL YOUR CHILD IS REMOVED FROM THE CARRIER.

- 1 While holding with one hand, use your other hand to unbuckle one of the shoulder straps.
- 2 Now use your other hand to hold the child and pull the loose shoulder strap behind the child's back.
- 3 While holding your child with one hand, unbuckle the other strap.
- 4 Bring the loose straps in front of your child while, always keeping one hand on them.
- 5 Your child is OK to now be removed from the carrier safely.

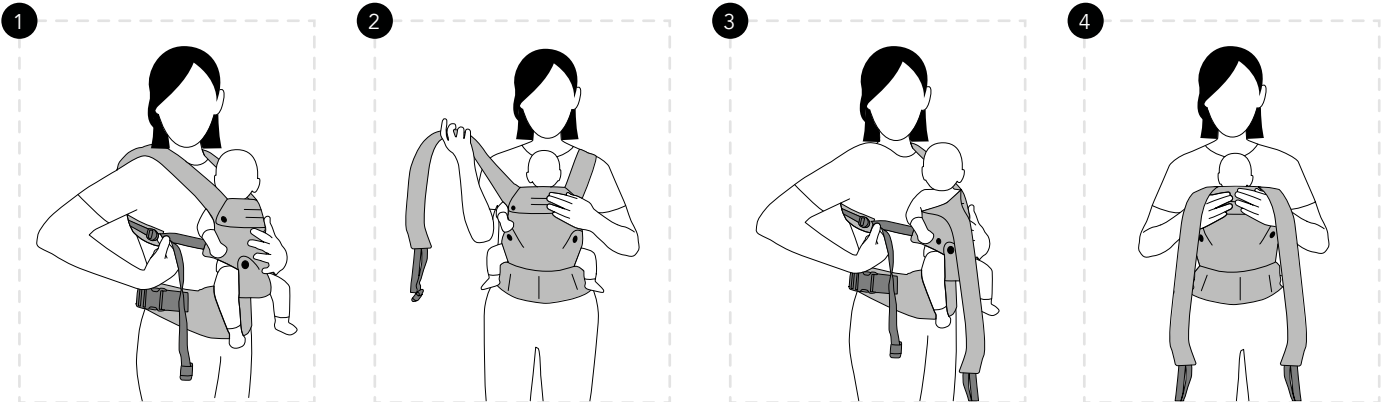

BACK CARRY

18LBS/8.2KG - 35LBS/16KG

BACK CARRY

⚠ WARNING ONLY USE THE BACK CARRY POSITION WHEN YOUR BABY HAS STRONG HEAD AND NECK CONTROL, AND IS ABLE TO SIT UNAIDED.

IMPORTANT:

- THE BACK CARRY CAN BE USED IN MIDDLE OR WIDEST SEAT SETTING. THIS CARRIER IS NOT INTENDED FOR USE IN A BACK CARRY IN THE NARROWEST SEAT SETTING.
- PLEASE HAVE SOMEONE ASSIST YOU UNTIL YOU FEEL COMFORTABLE PUTTING YOUR CHILD IN THIS POSITION ON YOUR OWN.
- THIGH SUPPORT SHOULD ALWAYS BE BUTTONED ONTO THE TOP MOST OUTER BUTTON WHEN WEARING YOUR BABY ON YOUR BACK.

- 1 Position the waist belt so that the panel is centred on the back of your body.
- 2 Position one of the straps over one arm.

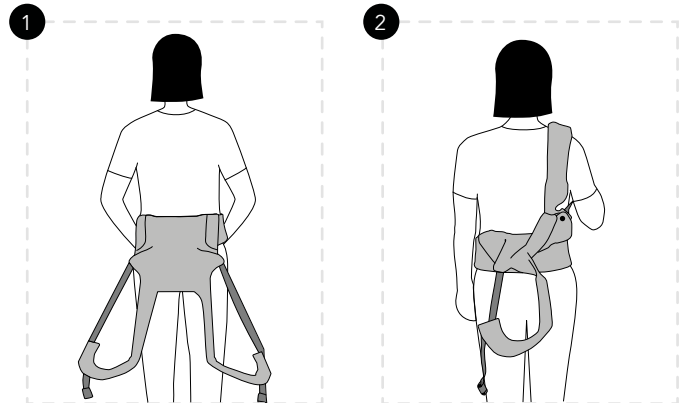

BACK CARRY CONTINUED

- 3 Place your child on the opposite hip.
- 4 Use the arm that is free from the strap to move your child from the hip position into the carrier, while using the arm in the strap to secure your child.

- 5 Lean forward slightly so your child can rest their weight on your back as you position them.

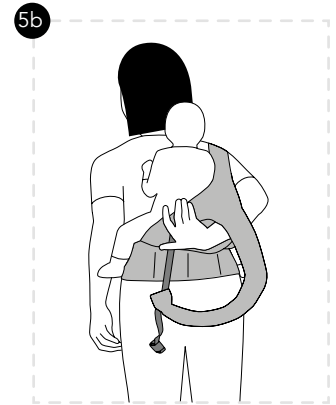
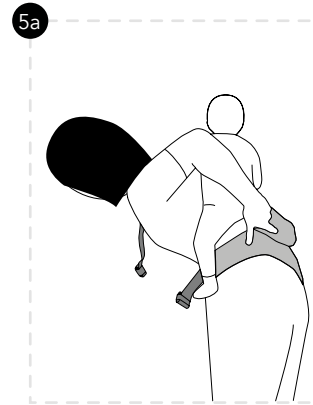
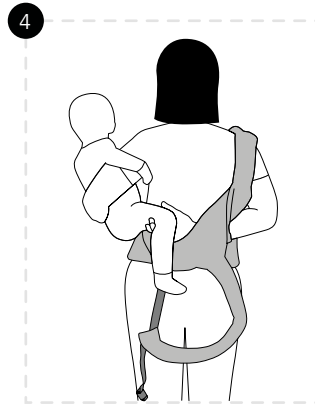

BACK CARRY CONTINUED

- 6 Maintaining a slight forward lean, smooth the panel up your child's back and slip your other arm through the second shoulder strap as though you are putting on a backpack.

- 7 Adjust the carrier from adjustable straps under your arm for a snug fit. Ensure your child is comfortable and close to your body.

- 8 Gently push on your child's calves so that the legs remain in an "M" position. Refer to page 11.

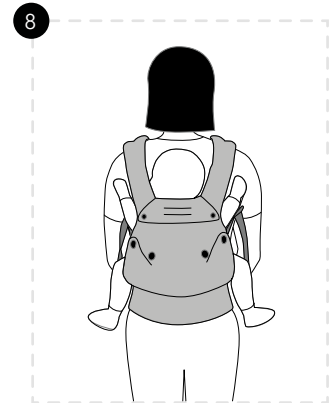
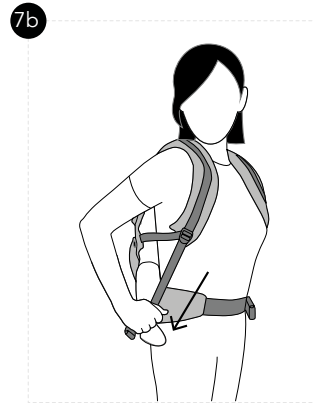
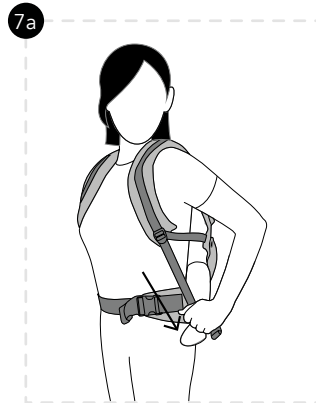
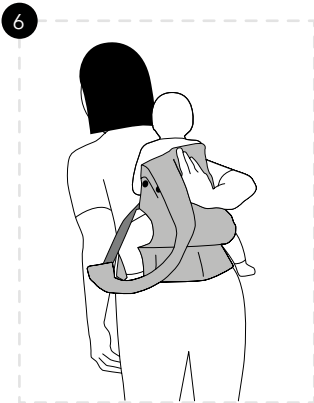

TO REMOVE YOUR CHILD FROM THE CARRIER:

IMPORTANT:

- DO NOT REMOVE THE WAIST BELT, UNTIL YOUR CHILD IS REMOVED FROM THE CARRIER.

- 1 To take your child out of the carrier, lean forward slightly and loosen the straps under the arms.
- 2 Remove the shoulder straps one at a time while always supporting your child with one hand.

- 3 Slide the child from your back to your hip.
- 4 Remove child from the carrier.

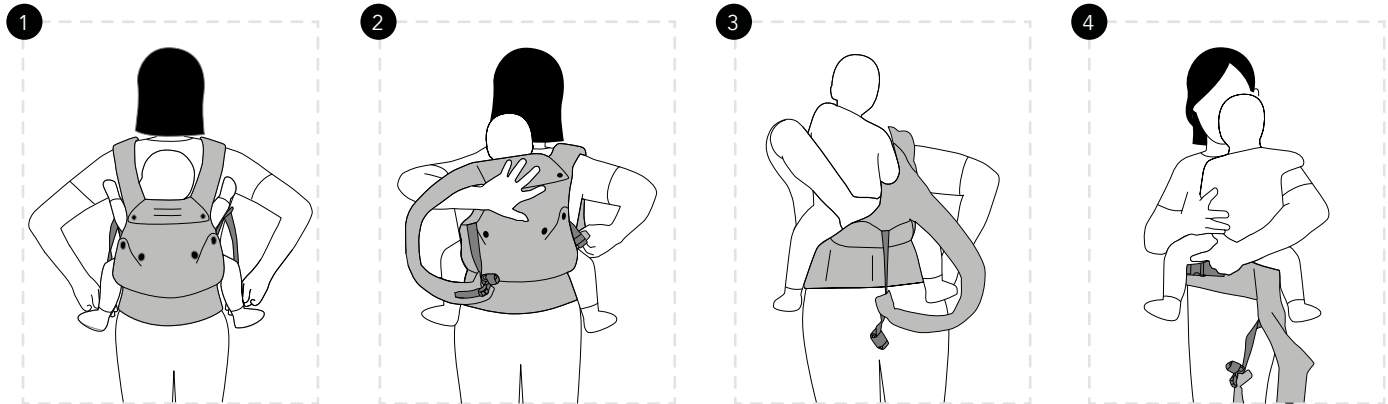

WASH & CARE:

WASH & CARE

Portier Limitless carrier is a complete ready to use product. We recommend spot cleaning your carrier with a soft cloth and warm water where possible.

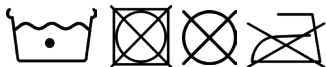

MACHINE WASH

Wash in cold water on a delicate washing cycle. Do not bleach. Line dry in the shade. Only use liquid detergent and do not use softeners. Do not Iron. Do no dry clean

DISCLAIMER:

Portier uses high quality dyes to ensure a product will retain its colour as much as possible. There is always a possibility that colours will fade with washing. Portier cannot be held responsible for fading due to washing.

Contact Portier customer service team for additional assistance if required.

portier

portier | www.portier.com.au | info@portier.com.au

PO BOX 362, Essendon, VIC, Australia, 3040 | +61 414 148 358