

USER MANUAL

**MODEL NAME: LOVECLEAN PRO UV STERILISER**

**MODEL NUMBER: LOV13001**

---



## Thank you for choosing LoveAmme®'s products!

Please read the user manual carefully before use.

The pictures here are for reference. We continually improve our products and the images may differ slightly from your product.

### CONTENTS

---

01 Warnings	2
02 Product Overview	3
03 Using the LoveAmme® LoveClean Pro	4
04 Function Settings	5
05 Tips for use	7
06 Product Parts Replacement	8
07 Cleaning & Maintenance	9
08 Authorised Distributors	9

---

### 01 WARNINGS

---

- 1) Unpack the product and check the accessories (User manual x 1, Steriliser tray x 1, Steriliser Rack x 1, Power Cord x 1)
- 2) Before use:
  - a) Check that the voltage indicated on the bottom of the appliance corresponds to your mains voltage. Connect the power cable provided to the steriliser's power socket. Connect cable to your mains power socket.
  - b) Wipe the inside of the UV Steriliser with a clean, damp cloth.
  - c) Put a few slices of lemon or ginger in the UV Steriliser. Do not place any other items in the steriliser.
  - d) Press the "Auto" (A) function button. Run this mode five times before use.
  - e) Open the lid for 12 hours to deodorise the new machine.
- 3) Do not lift or move the UV Steriliser during use.
- 4) Do not use accessories or parts produced by other brands as doing so will void the warranty of this product. The use of said accessories or parts which are not recommended or sold by LoveAmme® may cause potential injuries.
- 5) This product is not a toy. Do not place this product within reach of children or babies. This appliance should not be used by children.
- 6) If the UV lamp is damaged or needs to be replaced, it must be replaced with LoveAmme®'s specified UV Lamp or by any of our authorised service centres to avoid potential safety hazards.
- 7) If there is any breakage or damage to the UV Steriliser; or if the power cord is damaged, please stop using the appliance and send it to any of our authorised service centres for further inspection or repair (if required).
- 8) This product is designed for home and indoor use only.
- 9) This product can be used by persons with reduced physical, sensory or mental capabilities or lack of experience and knowledge if they are supervised or given proper instruction on the correct use of the UV Steriliser.
- 10) This UV Steriliser is only intended for the purpose described in this user manual. Do not use this UV Steriliser or any part of the appliance outside of its intended uses to avoid potential injuries and other hazards.
- 11) Do not use the Auto (A) , Dry ☼ and Storage ☐ funtion for electronic products.

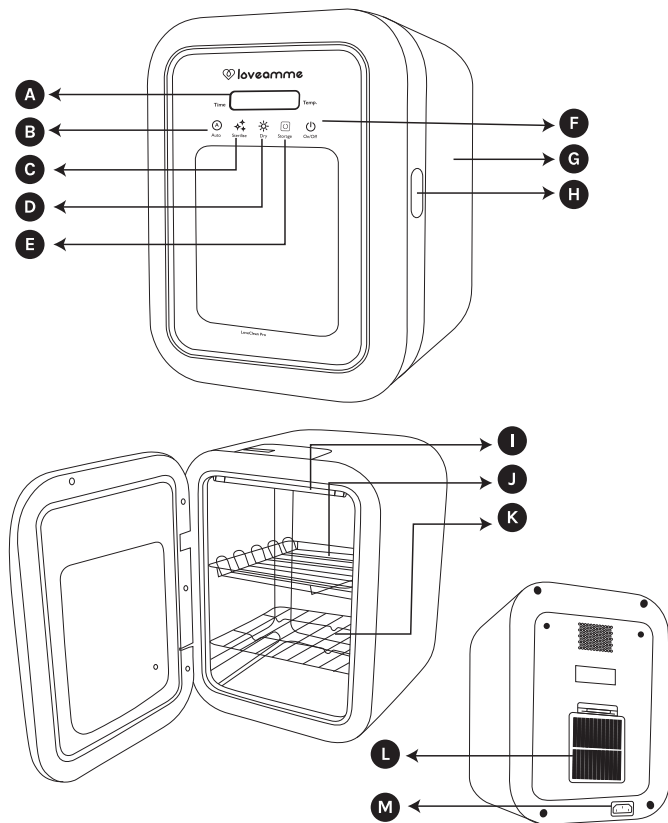

Item	Name
A	Digital Display
B	Auto Function Button
C	Sterilise Function Button
D	Dry Function Button
E	Storage Function Button
F	On/Off Button
G	Steriliser Casing

Item	Name
H	Door Handle
I	UV Lamp
J	Steriliser Tray
K	Steriliser Rack
L	Air Vent
M	Power Socket

### Materials and Min/Max of Temperature Sensitive Parts:

Name	Material	Maximum Temperature	Minimum Temperature
Tray and Rack	304 Stainless Steel	800°C	N/L
Inner Lining	304 Stainless Steel	800°C	N/L
Door Face	Tempered Glass	700°C	N/L
Casing	ABS Plastic	85°C	N/L

### Product Specifications:

Model Name: LoveClean Pro UV Steriliser  
 Model Number: LOV13001  
 UV Light Bulb: Philips TUV 4W G4 T5 x 2  
 Net Weight: 4.2 kg  
 Gross Weight: 5.5 kg  
 Product Dimensions: 370 x 286 x 320 mm  
 Sterilising Power: 8W  
 Drying Power: 180W  
 Voltage: AC 220V / ~50-60Hz  
 Inner Capacity: 16 Litres  
 Using Condition: Indoor / Home

### Safety Certification:

LoveClean Pro has been independently certified by international third party labs to meet IEC/EN 60335 standards, which is the European Standards governing the safety of electrical appliances intended for household use.

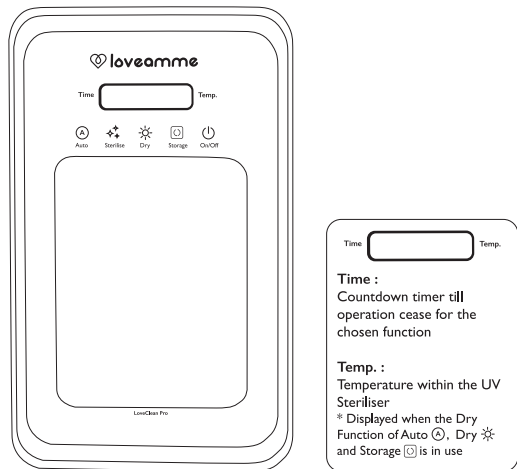

#### About the 4 Functions:

- (A) AUTO** This function is used when both drying and sterilising functions are needed. There are 3 timings for you to choose from - 30, 50 and 70 minutes.
- ✚✚ STERILISE** This function is used for sterilising objects only. There is no drying. There are 3 sterilising times for you to choose from - 5, 10 and 15 minutes.
- ☀ DRY** This function is used for drying objects only. There is no sterilisation. There are 3 drying times for you to choose from - 40, 50 and 60 minutes.
- (S) STORAGE** This function is used for keeping items sterilised in the UV Steriliser for up to 72 hours.

#### How to Operate:

- 1) Follow the pre-use instructions found under Warnings in Section I. As bacteria favour wet conditions, if you have not used your steriliser for a few days, it is recommended to first use the Dry ☀ Function before sterilising.
- 2) Wash items to be sterilised. Flick dry to remove excess water. Open the steriliser door and place them in the UV Steriliser. Place small feeding parts such as teats and neck rings on the Steriliser Tray. Close the door.
- 3) The height of items inserted into the steriliser should not exceed 29 cm if placed on the Steriliser Rack; 19.5cm if placed on the Steriliser Tray when it is installed at the middle ledge; and 9.5cm if placed on the Steriliser Tray when it is installed at the top ledge.
- 4) Plug the Power Cord into the Power Socket and press the On/Off (O) Button for one second. A beep will sound and all the lights will turn on for one second. Product is now on standby mode and the Digital Display will show “--- --”. The product is now ready for use.
- 5) Select your desired function. If nothing is displayed and the On/Off Button is blinking, the product is on Standby mode. To power up the device, press the On/Off (O) Button for one second and then select your desired function. The cycle will automatically start in 3 seconds.
- 6) If you have selected the wrong function, you can cancel your selection by simply pressing the On/Off (O) Button twice. If you wish to switch to another function, simply press the On/Off (O) Button twice and select the other function. The newly selected function will automatically start in 3 seconds.

#### Guidelines

- 1) Make sure to shake off excess water before placing items inside the product.
- 2) Have the items that will be sterilised face the upper direction (towards the direction of the UV lamp).
- 3) Do not stack the items for maximum sterilisation efficiency.
- 4) The Sterilise ✚✚ Function is for items that do not need drying or should not be heat-dried: mobile phone, remote control, toys etc.



### ☀ Dry Function

- a) This function is used for drying objects only. There is no sterilisation in this mode.
- b) Press the "☀" button. The "☀" button will flash 3 times and light up. This indicates that the drying cycle has started and it is a 40-minute cycle by default.
- c) There are 3 drying times for you to choose from - 40, 50 or 60 minutes. To select, toggle through the options by pressing the "☀" button while the numerical display is flashing in (b). The selection will flash 3 times and the drying cycle will start.
- d) When the drying function is running, the cycle can be cancelled by pressing the On/Off (⏻) Button twice.
- e) The numerical display indicates the number of minutes left in the cycle.
- f) There will be an air ventilation mode lasting a minute before the end of the cycle.
- g) When the drying cycle is complete, the beeper will sound 3 times and the UV Steriliser will enter the standby mode. Note: Appliance may be warm after usage. Please be careful when retrieving objects from the appliance.
- h) For Your Safety: When the door is opened during a cycle, the timer and the selected function will stop. If the door is closed within 10 seconds, the previous selected function will continue. Otherwise, the UV Steriliser will switch to standby mode.

### ✦ Sterilise Function

- a) This function is used for sterilising objects only. There will be no drying in this mode.
- b) Press the "✦" button, the "✦" button will flash 3 times and light up. This indicates that the sterilisation cycle has started. It is a 5-minute cycle by default.
- c) There are 3 sterilisation times for you to choose from - 5, 10 or 15 minutes. To select, toggle through the options by pressing the "✦" button while the numerical display is flashing in (b). The selection will flash 3 times and the sterilisation cycle will start.





- d) When the sterilising function is running, the cycle can be cancelled by pressing the On/Off (⏻) Button twice.
- e) The numerical display indicates the number of minutes left in the cycle.
- f) There will be an air ventilation mode lasting a minute before the end of the cycle.
- g) When the sterilisation cycle is complete, the beeper will sound 3 times and the UV Steriliser will enter the storage mode.
- h) For Your Safety: When the door is opened during a cycle, the timer will stop and the selected function will stop. If the door is closed within 10 seconds, the "✦" function will continue. Otherwise, the UV Steriliser will switch to standby mode.

### Ⓐ Auto Function

- a) This function is used when both drying and sterilisation functions are required.
- b) Press the "Ⓐ" button, the "Ⓐ" button will flash 3 times and light up. This indicates that the Auto Function has started – first with the drying mode, followed by the sterilising mode. It is a 50-minute cycle by default.
- c) There are 3 Auto time settings for you to choose from –
  - i) 30 minutes: 20 minutes of drying + 10 minutes of sterilisation
  - ii) 50 minutes: 40 minutes of drying + 10 minutes of sterilisation
  - iii) 70 minutes: 60 minutes of drying + 10 minutes of sterilisation
- d) To select duration, toggle through the options by pressing the "Auto" button while the numerical display is flashing in (b). The selection will flash 3 times and your selected Auto cycle will start.
- e) The numerical display indicates the number of minutes left in the Auto cycle. At the end of the drying mode, the sterilising mode will start automatically.
- f) There will be an air ventilation mode lasting a minute before the end of each cycle.
- g) When the "Ⓐ" cycle is completed, the beeper will sound 3 times and the UV Steriliser will enter the standby mode.
- h) For Your Safety: When the door is opened during a cycle, the timer and the selected function will stop. If the door is closed within 10 seconds, the previous selected function will continue. Otherwise, the UV Steriliser will switch to standby mode.



### Storage Function

- a) This function is used for keeping items sterilised in the UV Steriliser for up to 72 hours.
- b) Press the " and Storage  Functions are separate, with the Auto timer first running for 50 minutes, followed by the Storage timer running for 72 hours.
- c) The numerical display indicates the number of minutes left in the Auto or Storage cycle.
- d) Re-sterilisation is performed for one minute after every 1 hour and 59 minutes of storage.
- e) When the Storage  Function is running, the function can be cancelled by pressing the On/Off  Button twice.
- f) This program lasts for up to 72 hours before entering the standby state. When 72 hours is up, the beeper will sound 3 times and enter the standby state.
- g) For Your Safety: When the door is opened during a cycle, the timer will stop and the selected function will stop. If the door is closed within 10 seconds, the Storage  Function will restart, with 1 minute of sterilisation followed by 72 hours of storage. If the door is closed after >10 seconds, the UV Steriliser will start with 5 minutes of sterilisation followed by 72 hours of storage.



Please face bottle mouth opening upwards when placed into the sterilisation compartment.



Before placing the bottle, flick dry to remove excess water.

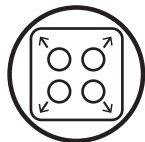

Please space out the items for more efficient sterilisation.

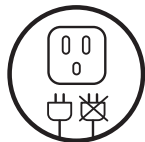

Do not use the same socket with other high power consumption appliances.



Time displayed shows the remaining time left for the selected function.



LoveClean can sterilise other items such as toys, clothes, blankets and small electronic items.



Press the function button to start. To cancel, wait for the indicator to stop flashing, then press the same function button.



Do not use the Dry ☀️, Auto Ⓐ or Storage Ⓛ Functions for electronic products. Only use the Sterilise ✨ Function.



### a. How to Replace the UV Tube:

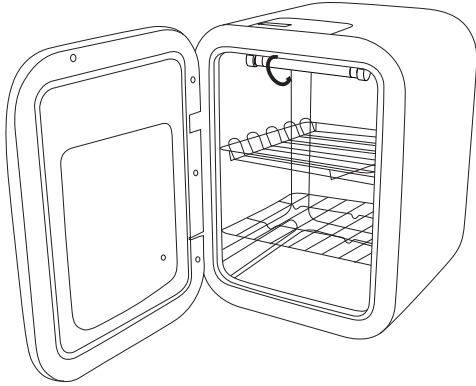

- 1) Ensure that the appliance is disconnected from the power supply. Only change the UV tube after the appliance has cooled down.
- 2) Lightly pinch the UV tube with both hands, and twist the tube towards you for approximately 45 degrees. You will feel a “click” when the tube is out of the socket. The pins of the bulb will align with the gaps in the tube holder. Pull the UV tube gently downwards to remove the tube.
- 3) Align the pins of the replacement tube with the gaps in the tube holder and insert into socket. Rotate it 45° inwards to install it. You will feel a “click” when it is properly installed.
- 4) It is recommended to replace the UV lamp every 18 months. The lifetime of the UV lamp exceeds 6000 hours of usage.
- 5) The UV lamp can be purchased from LoveAmme®’s Authorised Distributors.

### b. How to clean the filter in the plastic grille:

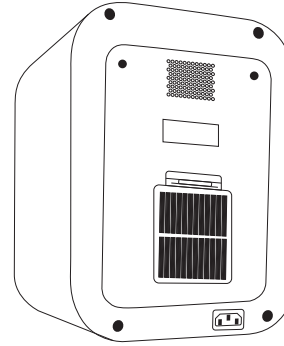

- 1) Ensure that the appliance is disconnected from the power supply. Only proceed to remove the filter to wash when the Steriliser has cooled down.
- 2) The air vent is covered by a plastic grille as indicated in the diagram.
- 3) Simply remove the plastic grille by pressing on to the catch located at the top of the grille.
- 4) Rinse the filter within the grille with water.
- 5) Leave the filter out to dry before installing the grille back onto the air vent.



## 07 CLEANING & MAINTENANCE



### ! Caution:

Clean the appliance immediately after every use.

Do not immerse the product into water or pour water directly into the product.

Do not use bleach, chemical solutions or cleaning tablets in the appliance.

Do not use steel wool, abrasive cleansers or corrosive liquid (such as petrol, acetone or alcohol) to clean the appliance.

### How to Clean:

- 1) **WARNING!** Before carrying out any cleaning, always ensure that the appliance is disconnected from the power supply. After use, there will be residual heat inside the product. Please allow the Steriliser to cool down before cleaning it.
- 2) Open the cover and remove the accessories tray.
- 3) Wipe the product with a dry towel or cotton cloth.

## 08 AUTHORISED DISTRIBUTORS

### Singapore:

Kim Hin Innovation Labs Private Ltd.  
601 Sims Drive, Pan-I Complex, Singapore 387382  
care.il@kimhinintl.com

### Malaysia:

Global Retail Network Sdn Bhd (921399-V)  
Wisma Pang Cheng Yean,  
Lot 5205C, Jalan Perindustrian Balakong Jaya 1/3,  
Taman Perindustrian Balakong Jaya,  
43300 Seri Kembangan,  
Selangor Darul Ehsan, Malaysia  
Tel: (03) 8940 6638  
contactus@globalretail.com.my

### Hong Kong:

Trade Solutions Ltd.  
Unit D, 13A, Gemstar Tower,  
No. 23 Man Lok Street, Hung Hom,  
Kowloon, Hong Kong  
Tel: (852) 2264 1282

### Connect with Mums

At the heart of LoveAmme® is a community of mums supporting and helping each other. Be a part of our community at [LoveAmmeOfficial@facebook](#) and [loveamme.official@instagram](#), tap into our feeding resources at [www.loveamme.com](#), or simply email us at [welcome@loveamme.com](#) to get connected.





**loveamme**  
love in every drop

## 感谢您选择使用LoveAmme® 产品

使用本产品之前，请仔细阅读本使用者手册，並妥善保管好本使用者手册以便日后参考。  
本使用者手册图片仅供参考，产品将持续改进，请以实物为准。

## 目錄

01 注意事项	11
02 产品介绍	12
03 使用方法	13
04 功能使用和操作	14
05 使用提示	16
06 零件更换方式	17
07 清洁和保养	18
08 授权经销商	18

## ! 01 注意事项

- 1) 打开包装取出产品并核对备件清单（使用者手册x 1，消毒器托盘 x 1，消毒器架子 x 1，电源线 x 1）
- 2) 使用前：
  - a) 在将本产品连接电源前，请先检查本产品标示的电压与电源供电电压是否相符。
  - b) 请用干净的半湿布擦拭机器内胆。
  - c) 请在机器内放置几片柠檬片或姜片。除此之外，切勿放置其他物件。
  - d) 按下自动功能键，并重复此操作5次。
  - e) 打开盖子，放置12小时以去除新消毒机的味道。
- 3) 在使用期间，请勿提起或移动本产品。
- 4) 切勿使用其他制造商生产或未经LoveAmme® 批准的附件或部件。如果您使用了此类附件或部件，本产品的保修将会失效。使用此类附件或部件也有可能对产品造成损坏或对消费者造成伤害。
- 5) 本产品不是玩具。切勿将本产品置于儿童可能接触到的地方。切勿任由儿童无人看管，确保不让儿童玩耍或使用产品与附件。为避免窒息风险，请勿让儿童玩耍任何包装塑料袋。
- 6) 为了避免风险，如果紫外线灯管损坏或需要更换，务必使用LoveAmme®指定紫外线灯管，或是前往经销商的LoveAmme®售后服务中心进行检查。
- 7) 如果产品有摔落或者任何损坏，请勿继续使用。请将其送往经销商的LoveAmme®售后服务中心进行检修。
- 8) 本产品仅供家用及室内使用。
- 9) 肢体不健全、知觉或精神上有障碍或缺乏相关经验和知识的人士不得使用本产品，除非有人监督或指导他们使用本产品进行，以确保他们安全使用，并且让他们明白相关的运作方式及危害。
- 10) 本产品仅限于本使用者手册内的说明进行使用。为了避免任何危害或损坏的发生，切勿将本产品用于其他不当或本使用者手册说明以外的用途。此类情况下保修将失效。
- 11) 切勿将本产品内的烘干功能、自动功能或储存功能用于任何电子产品。本产品唯有消毒功能适用于电子产品。

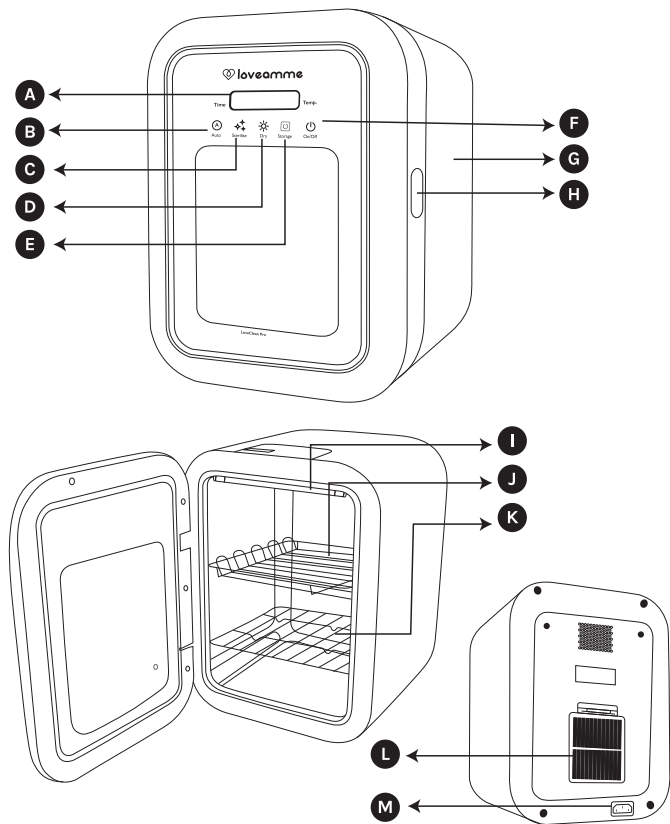

编号	名称	编号	名称
A	显示屏	H	手把
B	自动功能键	I	紫外线灯管
C	消毒功能键	J	消毒器托盘
D	烘干功能键	K	消毒器架子
E	储存功能键	L	进气孔
F	开关键	M	电源插座
G	消毒器箱体		

名称	材质	耐热温度	耐冷温度
托盘与架子	304 不锈钢	800° C	N/L
箱内	304 不锈钢	800° C	N/L
门面	钢化玻璃	700° C	N/L
箱体	ABS塑料	85° C	N/L

#### 产品参数:

产品名称: LoveClean Pro 紫外线消毒烘干柜  
 产品型号: LOV13001  
 UV灯管型号: Philips TUV 4W G4 T5  
 产品净重: 4.2kg  
 产品毛重: 5.5kg  
 产品尺寸: 370 x 286 x 320mm  
 消毒功率: 4W  
 烘干功率: 180W  
 额定电源: AC 220V / ~50Hz-60Hz  
 内胆容量: 16L  
 使用环境: 家用/室内使用

#### 执行标准:

LoveClean Pro 消毒器经国际协力厂商认证机构的测试, 并被认证已通过IEC/EN 60335标准。本标准为家用及类似用途电器安规标准通用要求。

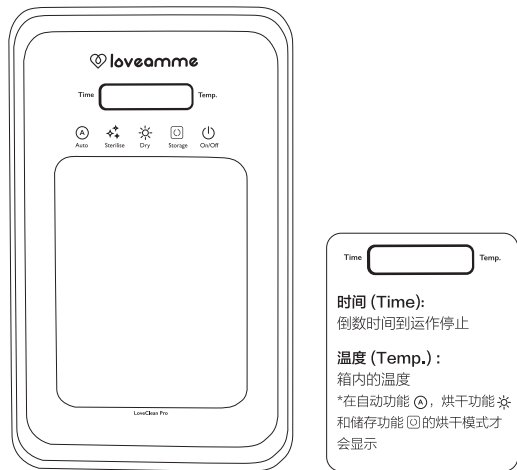

### 本产品功能介绍:

- Ⓐ **自动功能** 此功能适合在在需要烘干及消毒物件的情况下使用。自动功能时间分别有3个时段可选择 - 30, 50 或 70分钟。
- ✳ **消毒功能** 此功能适合只需消毒物件，不需要烘干的情况下使用。消毒功能时间分别有3个时段可选择 - 5, 10 或 15分钟。
- ☀ **烘干功能** 此功能适合只需烘干物件，不需要消毒的情况下使用。烘干功能时间分别有3个时段可选择 - 40, 50 或 60分钟。
- 📦 **储存功能** 此功能适合较长时期将物件储存在已消毒的环境内。储存功能可长达72小时。

### 如何操作:

- 1) 请遵循注意事项内的说明。因细菌易在潮湿状态下滋生，建议每次使用前先烘干 ☀ 功能才进行其他功能。
- 2) 清洗需要烘干或消毒的物件。放置物件之前，请将该物件或物件上的水尽量甩干，再将物件置入紫外线消毒器内。将奶嘴及其他小型用具放置在消毒器托盘上，再将消毒器门关上。
- 3) 若用消毒器架子，物品高度不能超过29公分。若消毒器托盘安装在中间的壁架时，请确保物品不超过19.5公分。若消毒器托盘安装在上面的壁架时，请确保物品不超过9.5公分。
- 4) 接通电源后，请按开关 ⏻ 键。一秒之后，消毒器将发出“滴”一声，数码显示及功能键将会亮起一秒钟后关闭。显示屏会显示“-----”，表示消毒器已进入待机模式。
- 5) 选择想进行的功能并按下相对的按键。若数码显示上没有任何显示，而开关键持续闪烁，标示消毒器正处于待机模式。在此情况，请按开关 ⏻ 键一秒开机后再选择项进行的功能，所选功能将在三秒后自动开启。
- 6) 错过功能的情况下，请点击开关 ⏻ 键两次，即可取消错选的功能。取消了以后，直接点击想进行的功能键，所选功能将在三秒后自动开启。

### 使用指南:

- 1) 请尽量将物件多余的水分甩干后再将物件置入消毒器。
- 2) 置入待消毒物品时，请将物品朝上放置（对着紫外线灯管的方向）。
- 3) 为了达成消毒的最高效率，请勿重叠物品。
- 4) 消毒 ✳ 功能最适合适用于无需烘干或不能烘干的物件，如：手机，遥控器，玩具等物件。



## 04 功能使用和操作

### ☀ 烘干功能

- a) 此功能只限于烘干物件，并不进行消毒。
- b) 点击烘干 ☀ 功能键。烘干 ☀ 功能键将闪烁3次后持续亮着，显示烘干功能已自动开启。预设烘干时间是40分钟。
- c) 烘干功能时间分别有3个时段可选择 - 40, 50 或 60分钟。在 (b) 步骤烘干 ☀ 功能键闪烁时，继续点击该功能键即可选择所需的烘干时间。所选时间将会闪烁3次后持续亮着，显示烘干功能已自动开启。
- d) 进入烘干功能后，点击开关 ⏻ 键两次，可取消进行中的烘干功能。
- e) 烘干功能时间倒数将显示在显示屏上。
- f) 烘干功能结束前1分钟，消毒器自动进入换气。
- g) 烘干功能结束时，消毒器会响三声然后直接进入持用的状态。注意：烘干功能结束后，消毒器内胆会处于温热状态。
- h) 为了您的安全：若消毒器的门在功能进行的半途中被打开，显示屏和烘干功能将会停止。如果消毒器的门在10秒钟内关上，烘干功能将继续进行。否则，消毒器将进入待机模式。

### ✦ 消毒功能

- a) 此功能只限于消毒物件，并无烘干。
- b) 当您点击消毒 ✦ 功能键后，消毒 ✦ 功能键将闪烁3次后持续亮着，显示消毒功能已自动开启。默认消毒时间是5分钟。
- c) 消毒功能时间分别有3个时段可选择 - 5, 10 或 15分钟。在 (b) 步骤数码显示灯闪烁时，继续点击该 ✦ 功能键即可选择所需的消毒时间。所选时间将会闪烁3次后持续亮着，显示消毒功能已自动开启。
- d) 进入消毒功能后，点击开关 ⏻ 键两次，可取消进行中的消毒功能。
- e) 消毒功能时间倒数将显示在显示屏上。
- f) 消毒功能结束前1分钟，消毒器自动进入换气。
- g) 消毒功能结束时，消毒器会响三声然后直接进入储存功能。

- h) 为了您的安全：若消毒器的门在功能进行的半途中被打开，显示屏和消毒 ✦ 功能将会停止。如果消毒器的门在10秒钟内关上，烘干功能将继续进行。否则，消毒器将进入待机模式。

### Ⓐ 自动功能

- a) 此功能适合在在需要烘干及消毒物件的情况下使用。
- b) 点击自动 Ⓐ 功能键。自动 Ⓐ 功能键将闪烁3次后持续亮着，显示自动功能已自动开启。默认时间是50分钟。
- c) 自动功能时间有3个时段可选择：
  - i) 30分钟：20分钟烘干功能 + 10分钟消毒功能
  - ii) 50分钟：40分钟烘干功能 + 10分钟消毒功能
  - iii) 70分钟：60分钟烘干功能 + 10分钟消毒功能
- d) 在 (b) 步骤数码显示灯闪烁时，继续点击该功能键即可选择所需的时间。所选时间将会闪烁三次后持续亮着，显示自动功能已自动开启。
- e) 进入自动功能后，点击开关 Ⓐ 键两次，可取消进行中的自动功能。
- f) 自动功能时间倒数将显示在显示屏上。
- g) 自动功能结束前1分钟，消毒器自动进入换气。
- h) 自动功能结束时，消毒器会响三声然后直接进入持用的状态。若消毒器的门在功能进行的半途中被打开，数码显示和自动功能将会停止。如果消毒器的门在10秒钟内关上，自动功能将继续进行。否则，消毒器将进入持用的状态。



## 04 功能使用和操作

### ☐ 储存功能

- a) 此功能可用于在机器内储存已消毒的物件长达72小时。
- b) 点击储存 ☐ 功能键。储存 ☐ 功能键将闪烁3次后持续亮着，显示储存功能已自动开启。每一轮循环包括40分钟烘干功能 + 10分钟的消毒功能，机器再进入储存模式。自动 Ⓐ 功能和储存 ☐ 功能的显示是分开的，自动功能倒数50分钟结束后，才开始显示储存功能的72小时倒数。
- c) 自动功能 / 储存功能时间倒数将显示在显示屏上。
- d) 本机器每个两小时将会自动开启长达一分钟的消毒功能。
- e) 进入储存功能后，点击开关 Ⓛ 键两次，可取消进行中的储存 ☐ 功能。
- f) 消毒器进入待机模式之前，此功能将可长达72小时。72小时后，消毒器会进入待用的状态。
- g) 为了您的安全：若消毒器的门在储存功能进行的半途中被打开，显示屏和储存 ☐ 功能将会停止。如果消毒器的门在10秒钟内关上，储存功能进行1分钟的消毒功能然后将重新进行72小时的储存功能。如果消毒器的门在10秒钟后才关上，消毒器会进行5分钟的消毒功能然后将重新进行72小时的储存功能。



请将奶瓶口向上垂直放入消毒剂内胆。



放置奶瓶前，先将奶瓶内的水尽量甩干。

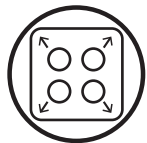

消毒时，请尽量展开需要杀菌的物品。

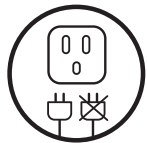

请勿与其他高功率电器使用同一个插座。



数码显示上的时间为功能剩余工作时间。



LoveClean 可对玩具、衣服、被单和小型电子产品等物件进行消毒。



点击当前模式按键启动，待指示灯停止闪烁，再点击当前模式按键即可取消。



请勿对电子产品进行烘干。此类物件仅限于使用消毒功能。





### a. 紫外线灯管更换方式:

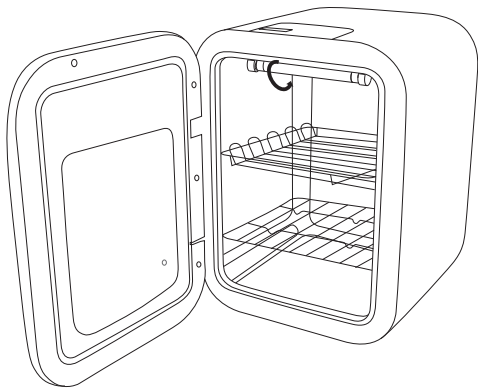

- 1) 请先确保本产品的电源插头已取下。当确保机器已完全冷却后，您才可更换紫外线灯管。
- 2) 双手轻轻的捏着紫外线灯管然后将灯管朝自己转约45度。当灯管旋转至插座开口时，轻轻将灯管往下方拉出来。
- 3) 将新的紫外线灯管插入并向内45度旋转以完成装置。
- 4) 为了最佳运作与消毒状态，建议每18个月更换一次紫外线灯管。紫外线灯管的寿命可长达6000小时的使用时间。
- 5) 您可以在经销商的LoveAmme®售后服务中心购买紫外线灯管。

### b. 过滤棉网更新方式:

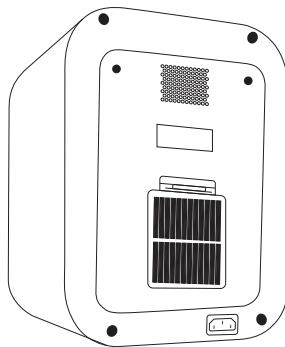

- 1) 请确保电源线插头已取下。请确保消毒器已完全冷却，方才更换过滤棉网。
- 2) 进气孔上装有塑料盖，请参考以上图片。
- 3) 轻轻的按着处于塑料盖上方的勾并将塑料盖朝自己拉开。
- 4) 用水冲洗过滤棉网。
- 5) 请待过滤棉网干了再将塑料盖安装归位。



## 07 清洁和保养

### ⚠ 注意事项:

每次使用后都应该立即清洁产品。  
切勿将本产品直接于入水中，切勿将水直接倒在产品上。  
切勿在产品内使用漂白水、化学剂或清洁片剂。  
切勿使用钢丝绒、研磨性清洁剂或腐蚀性液体（汽油、丙酮或酒精等）来清洁本产品。

### 清洁方式:

- 1) **警告!** 在开始清洁本产品之前，请确保已经切断电源并将插头剥离插座。本产品在使用完过后会有余温，请确保本产品已完全冷却后才开始清洁。
- 2) 打开消毒器门并将消毒托盘与架子取出。
- 3) 用干毛巾或干棉布擦拭产品。

## 08 授权转销商

### 新加坡:

Kim Hin Innovation Labs Private Ltd.  
601 Sims Drive, Pan-I Complex, Singapore 387382  
care.il@kimhinintl.com

### 马来西亚:

Global Retail Network Sdn Bhd (921399-V)  
Wisma Pang Cheng Yean, Lot 5205C, Jalan Perindustrian Balakong Jaya 1/3,  
Taman Perindustrian Balakong Jaya, 43300 Seri Kembangan,  
Selangor Darul Ehsan, Malaysia  
Tel: (03) 8940 6638  
contactus@globalretail.com.my

### 香港:

Trade Solutions Ltd.  
Unit D, 13A/F, Gemstar Tower, 23 Man Lok Street, Hungghom,  
Kowloon, Hong Kong  
Tel: (852) 2264 1282

### 与妈妈们联系

LoveAmme®的核心是由一群互相扶持，互相协助的妈妈们共同建立起的社区。您可以通过LoveAmmeOfficial@facebook 及loveamme.official@instagram 加入成为我们社区的一份子、在 [www.loveamme.com](http://www.loveamme.com) 摄取更多有关婴儿辅食的相关资料，或发送电邮至[welcome@loveamme.com](mailto:welcome@loveamme.com) 与我们联系。

