



Beautifully tailored with a dressmaker skirt, the Eleanor Bench is a classic staple for the end of the bed. Available in 3 sizes to correspond with a Twin, Queen, and King bed, the Eleanor Bench is also stunning in front of a window or as a dining bench. For added customization, add a contrast fabric on the top or a contrast welt.

#### FRAME CONSTRUCTION

##### WOOD:

Responsibly harvested engineered hardwood with interlocking glued joints that are corner blocked for durability

##### SPRINGS:

Supportive, durable elastic webbed base

##### POLY:

All of the foam used in our pieces is CertiPUR-US® certified. None of the foam used in our products contain flame retardants. All of our products are TBI 17-2013 compliant

#### AVAILABLE CUSTOMIZATIONS

SMALL (30"), MEDIUM (50"), OR  
LARGE (66") LENGTH

CONTRAST TOP

CONTRAST WELT

CONTRAST TRIM OR BAND

---

#### QUESTIONS?

HELLO@COLEYHOME.COM

980.237.9861

SMALL

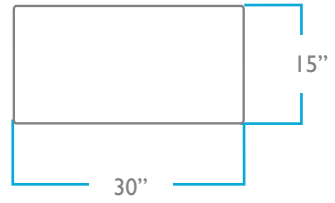
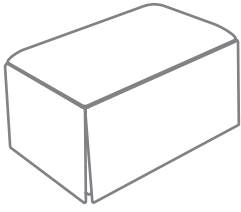

MEDIUM

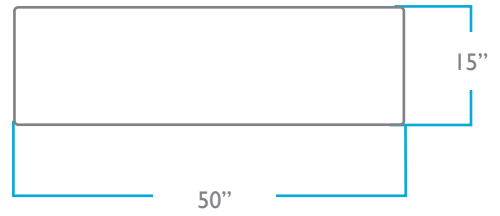
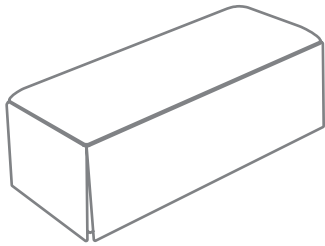

LARGE

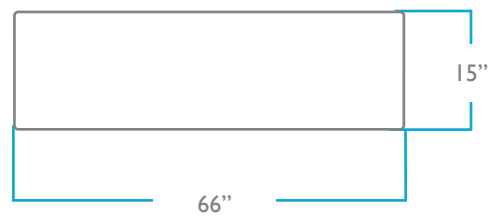
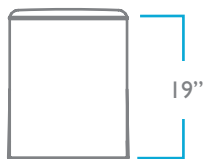
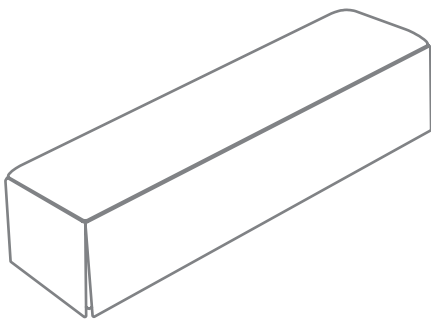

OVERALL

HEIGHT: 19"

DEPTH: 15"

PACK WEIGHT

SMALL: 30 LBS

MEDIUM: 40 LBS

LARGE: 45 LBS