



COLEY HOME

THE CROWN BED ASSEMBLY GUIDE



STEP ONE:

Take the compressed headboard out of the box and remove plastic.



STEP TWO:

Lay the headboard flat on the ground. Let it expand for about 1-3 hours.
Once fully expanded, the foam will be 4 inches thick.



STEP THREE:

Pull the slipcover over the headboard, matching the seams with the edges of the headboard.
Keep tugging! It is tight for a reason!

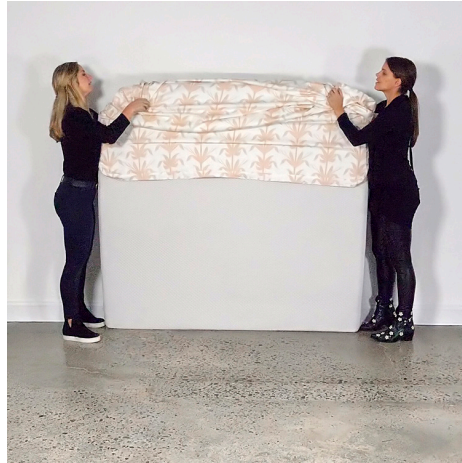

STEP FOUR:

Zip the bottom of the slipcover and place the headboard against your wall. The foam will continue to expand over the next 24 hours. Once fully expanded, adjust the seams to align with the edges of the headboard.



TIPS + CARE

After removing the plastic, take a break! The headboard requires 1-3 hours to come back to life. The longer it is in the box, the longer the foam will take to reshape.

Place a pillow on top of the headboard while it expands to help remove the arch from packaging.

Before you put on the slipcover, **steam or lightly iron** it to remove any creases leftover from packaging.

It is best to dry clean your slipcover. Spot clean when necessary for minor stains. Only use a mild water-free solvent. Let it breathe. Air dry is the best dry!





COLEY HOME

BED FRAME ASSEMBLY GUIDE



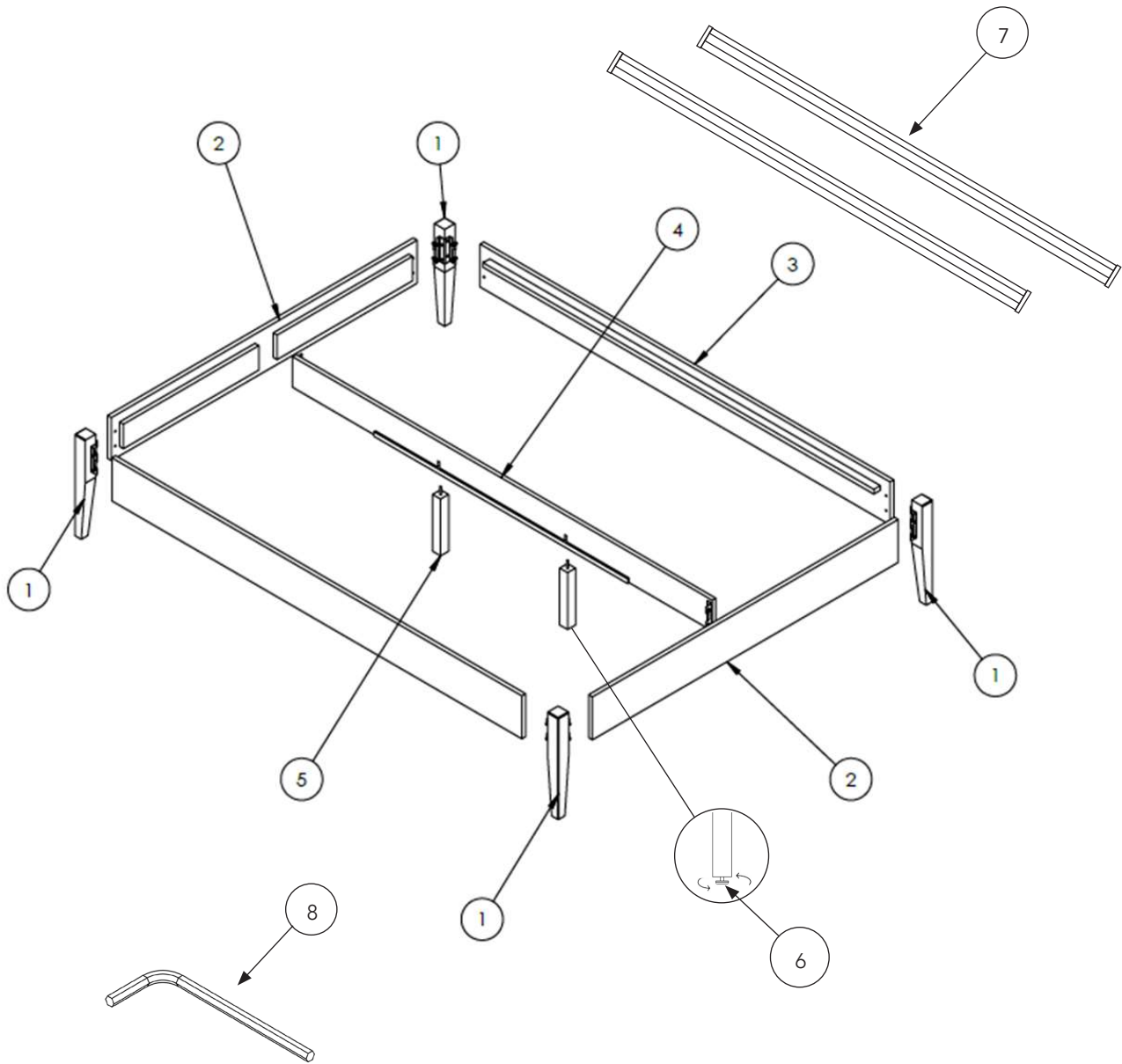

9



EXTRA LEG BRACKET SCREWS

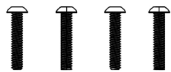

EXTRA SIDE RAIL BOLTS

ITEM NUMBER	DESCRIPTION	QUANTITY
1	OAK LEGS	4
2	FRONT/BACK RAIL	2
3	LEFT/RIGHT RAIL	2
4	CENTER RAIL	1
5	CENTER RAIL LEGS	2
6	ADJUSTABLE LEG GRIP	2
7	SLATS	2
8	ALLEN WRENCH	1
9	EXTRA SCREWS	

STEP ONE:

Connect the wooden legs to the upholstered rails.

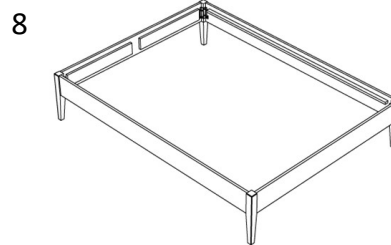
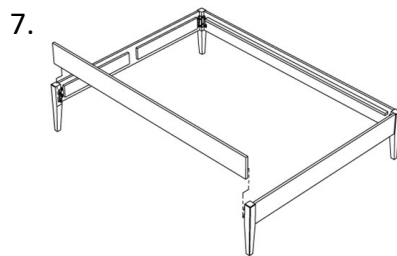
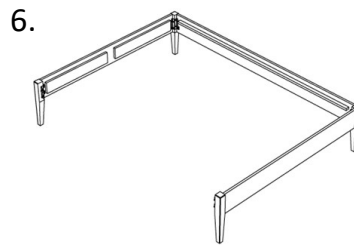
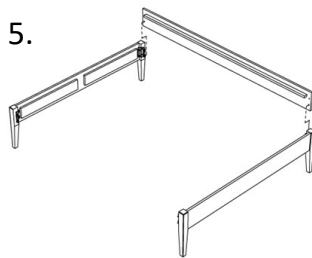
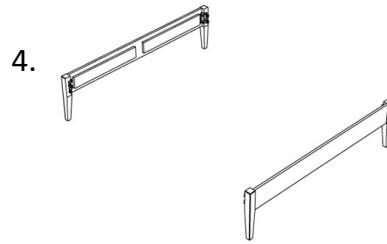
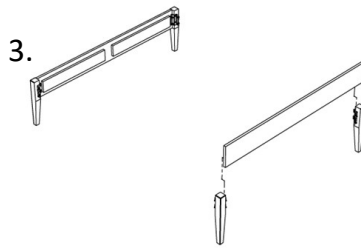
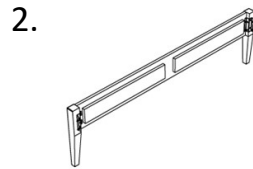
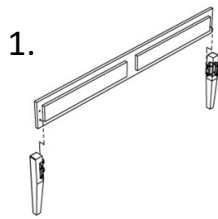
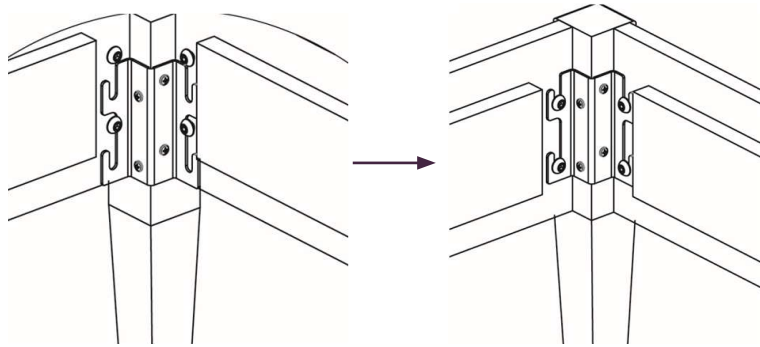

STEP TWO:

A Insert the center rail legs into into the center rail. **B** Insert the center rail into the bolts on the front and back rails. **C** If needed, adjust the height of the grip at the bottom of the center rail legs based on your carpet height.

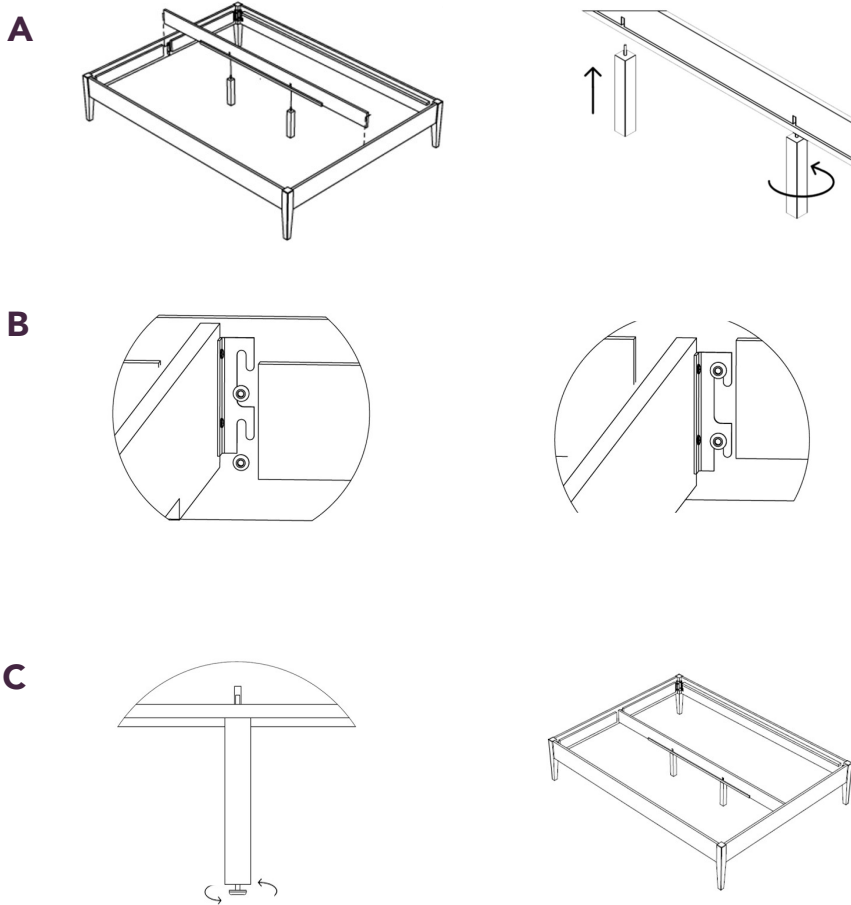

STEP THREE:

Use the Allen wrench to tighten the bolts. Place the two sets of slats neatly inside the bed frame. Slide directly against your headboard, place your mattress on top and enjoy!

