



COLEY HOME

BED FRAME ASSEMBLY GUIDE





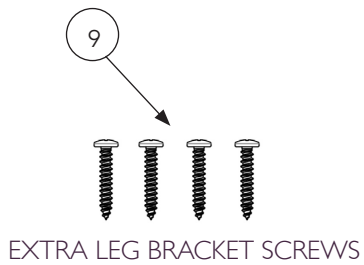
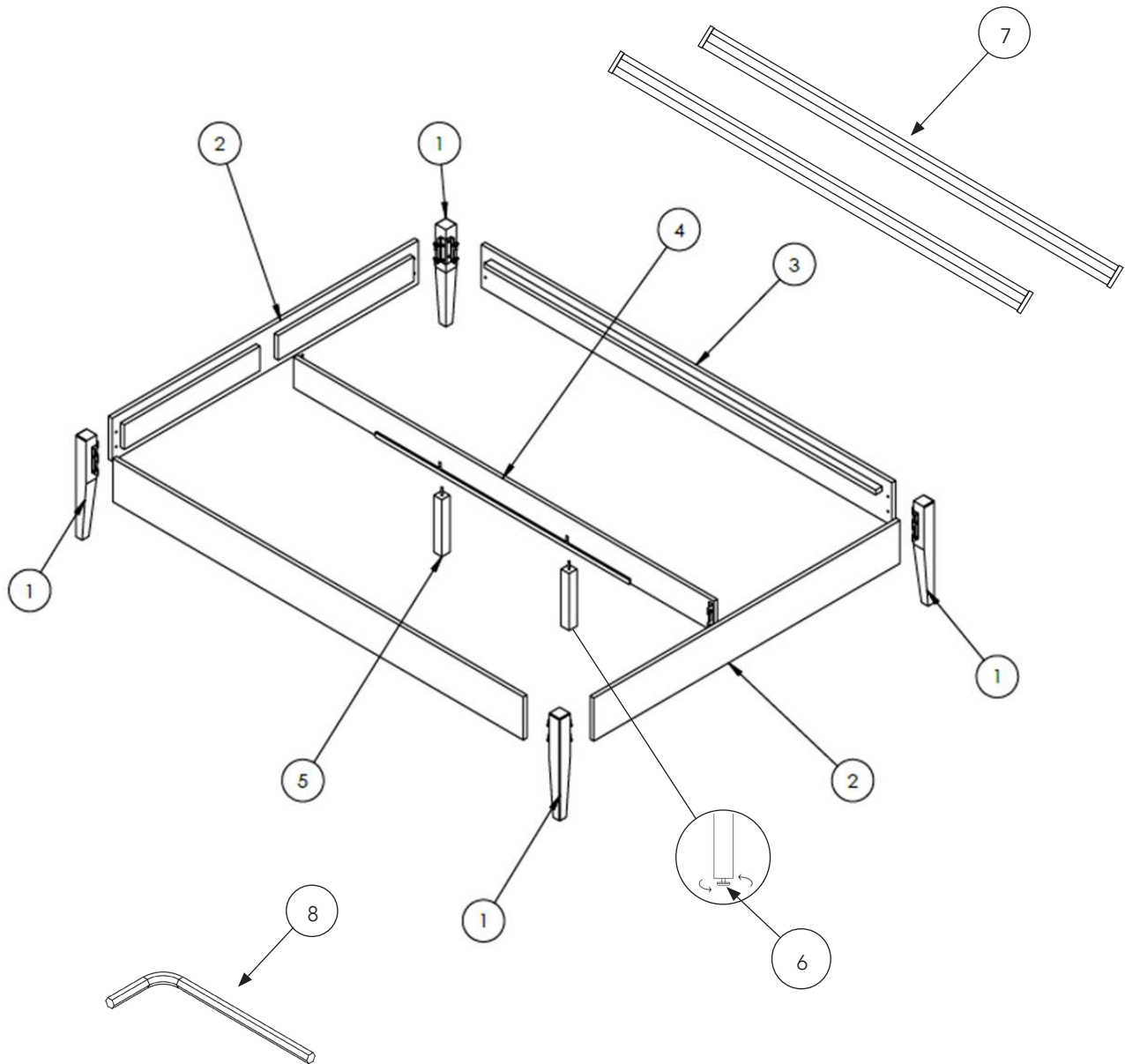

ITEM NUMBER	DESCRIPTION	QUANTITY
1	OAK LEGS	4
2	FRONT/BACK RAIL	2
3	LEFT/RIGHT RAIL	2
4	CENTER RAIL	1
5	CENTER RAIL LEGS	2
6	ADJUSTABLE LEG GRIP	2
7	SLATS	2
8	ALLEN WRENCH	1
9	EXTRA SCREWS	

STEP ONE:

Connect the wooden legs to the upholstered rails.

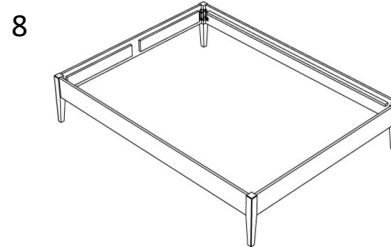
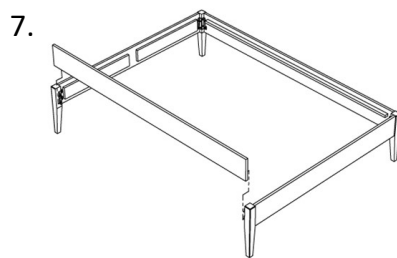
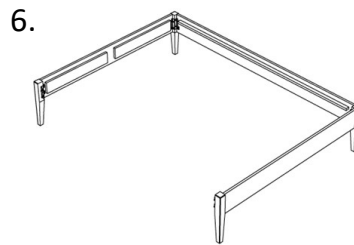
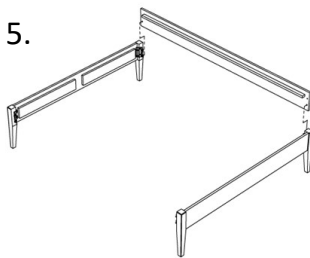
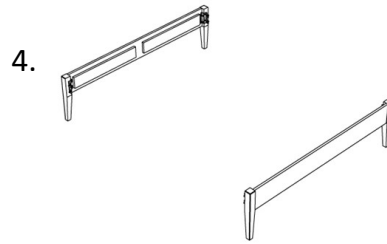
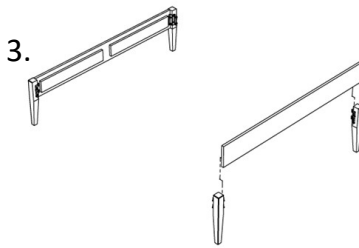
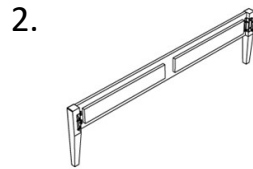
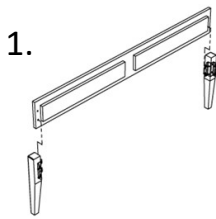
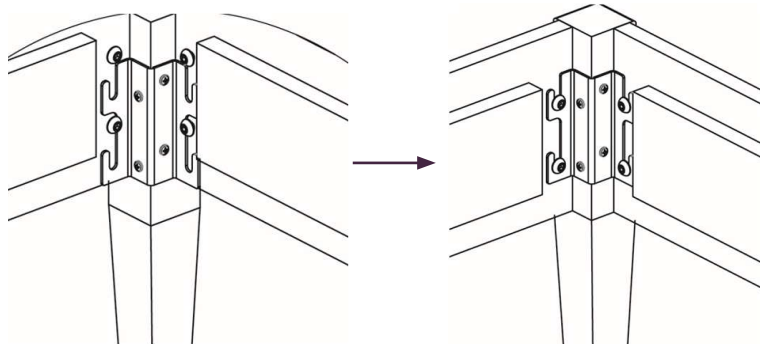

STEP TWO:

A Insert the center rail legs into into the center rail. **B** Insert the center rail into the bolts on the front and back rails. **C** If needed, adjust the height of the grip at the bottom of the center rail legs based on your carpet height.

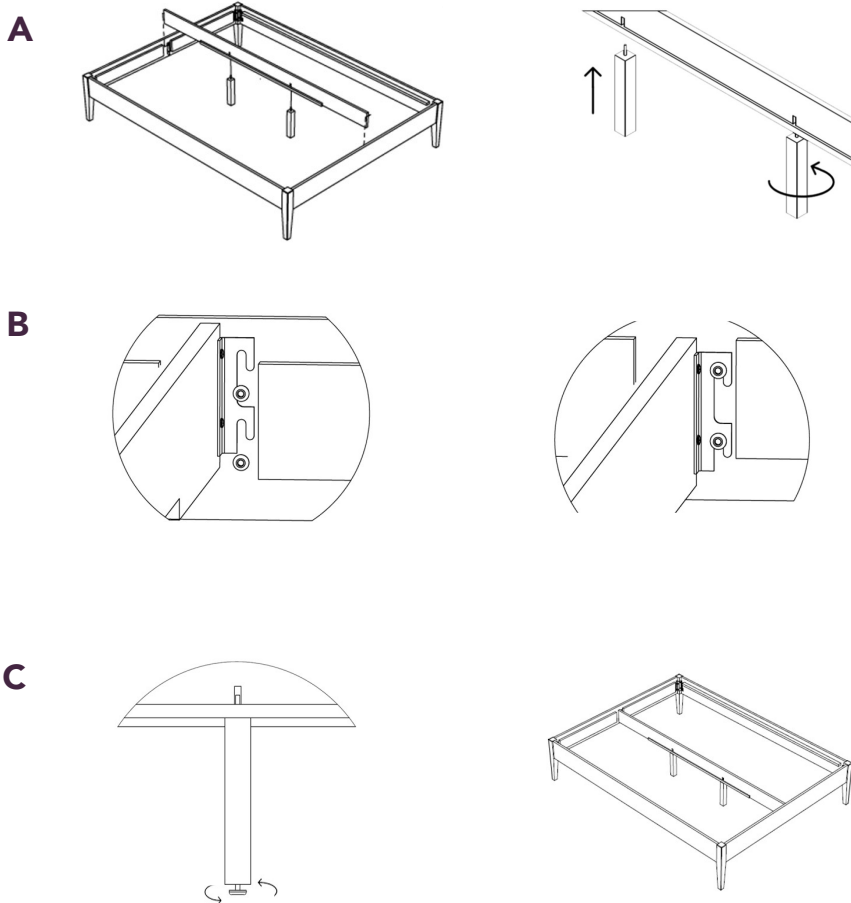

STEP THREE:

Use the Allen wrench to tighten the bolts. Place the two sets of slats neatly inside the bed frame. Slide directly against your headboard, place your mattress on top and enjoy!

