



**BB2000**

---

OWNER'S MANUAL

---





**PRODUCT INFORMATION**

Important Safeguards.....4  
Main Unit & Parts.....10  
Dimensions.....11  
Remote Control.....12  
Operation.....14

**PRODUCT INSTALLATION**

Installation.....25  
Unit Separation.....29

**PRODUCT SETTINGS**

Maintenance.....30  
Water Draining.....32  
Troubleshooting.....33  
Specifications.....34

**WARRANTY**

Warranty.....35  
Information to the User.....38



## **DANGER - To reduce the risk of electrocution**

## **WARNING - To reduce the risk of burns, electrocution, fire, or injury to the persons**

## **PLEASE OBSERVE THE FOLLOWING PRECAUTION BEFORE USING THIS PRODUCT**

### **READ ALL INSTRUCTIONS BEFORE INSTALLATION AND USE**

1. Do not open the product to repair or remodel. Only qualified service personnel should service this product. Do not use attachments not recommended by the manufacturer.
2. Connect this product to a cold water supply pipe carrying potable water. Do not connect to an industrial water supply line that does not carry water of drinking quality. This will negatively effect hygiene and performance.
3. **Low Temperature Burns** - A burn occurs when the skin has been exposed to high temperatures. However, a low temperature burn may occur when the skin has been in contact with an object at relatively low temperature (about 104°F). Close supervision is necessary when this product is used by children or adults with sensitive skin.
4. If using any chemical toilet bowl cleaner, be sure to wipe up any spills that splash onto the electric bidet. Do not use benzene or any acid chemical detergent. Only neutral detergent permitted.
5. Do not plug in the power cord before connecting the water supply hose.
6. This product must be grounded. An approved Ground Fault Circuit Interrupt must be used.
7. Do not splash water on this product. Please provide adequate ventilation to avoid high levels of humidity which can damage the electronic components. It is necessary to provide adequate ventilation with a fan, open door, or open window when bathing.

8. Do not touch the power cord with wet hands. Do not reach for a product that has fallen into water. Unplug immediately!
9. This product must be connected to a standard voltage power source. Do not connect power cord if the cord is damaged or broken. Do not plug the unit into a loose electric outlet.
10. Please disconnect the power cord when you clean this product or detach it from toilet bowl. Do not supply electrical power to the unit until the plumbing work has been completed.
11. Keep the electrical cord away from heated surfaces to prevent a fire hazard. Also, keep any flammable materials away from this product at all times.

### **GENERAL CAUTIONS**

1. Never operate this product if it is not working properly, if it has been dropped or damaged, or dropped into water. Return the product to a service center for examination and repair.
2. Do not stand or sit on the seat cover lid. It is not designed to support a user's body weight.
3. Allow the seat and lid to close automatically. Do not force the lid closed.
4. Do not strain or push the connected hose and tube connector; it may cause water leakage. Never drop or insert any object into any opening or hose. Use proper plumbing supplies if any modification is to be made.
5. Use this product only as described in the operating instructions. Never use while sleeping or drowsy. Do not use while bathing.
6. Be careful so that this product does not become stained with excrement and urine.
7. Drain the water from unit and unplug the power if this product is not going to be used for an extended period of time.



## CAUTIONS BEFORE INSTALLATION:

### WIRING REQUIREMENT

- **THIS PRODUCT MUST BE PLUGGED** into a regular voltage grounded GFCI outlet (North America 120V ac). The rated power consumption is 1400W. In locations where only a standard two-prong outlet is available, it is the responsibility of the user to install a grounded three-prong outlet. Using a higher voltage is dangerous and may result in a fire or other accident. This product is not responsible for damage resulting from the use of it on other than specified voltage, or operating it without proper grounding.

### WARNING

- This product must be on a separate circuit. No other appliance should share the circuit with this product. Sharing a circuit could cause the branch circuit fuse to blow or the circuit breaker to trip. Continuous usage under these conditions could result in fire or property damage.

### GROUND INSTRUCTIONS

1. This product has a three-prong grounding plug, which must be plugged into an outlet that is properly installed and grounded. In the event of an electrical short circuit, grounding reduces the risk of electric shock by providing an escape wire for the electric current. If repair or replacement of the cord or plug is necessary, do not connect the grounding wire to either flat blade terminal. The wire with insulation having an outer surface that is green with or without yellow stripes is the grounding wire. Check with a qualified electrician or service person if the grounding instructions are not completely understood, or if in doubt as to whether the product is properly grounded.

2. This product is for use on a nominal 120V circuit, and has a grounding plug that looks like the plug illustrated in sketch A in Figure 1. A temporary adapter, which looks like the adapter illustrated in sketches B and C, may be used to connect this plug to a 2-pole receptacle as shown in sketch B if a properly grounded outlet is not available. The temporary adapter should be used only until a properly grounded outlet (sketch A) can be installed by a qualified electrician. The green colored rigid ear, lug, or the like extending from the adapter must be connected to a permanent ground such as a properly grounded outlet box cover. Whenever the adapter is used, it must be held in place by the screw.

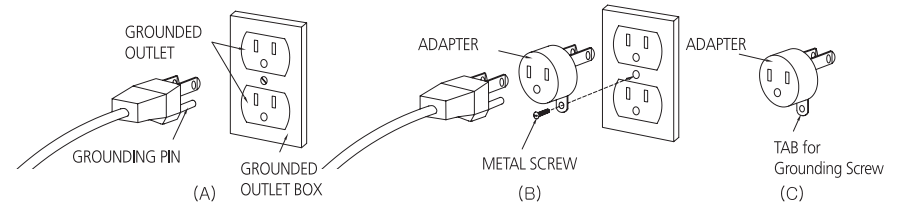

- Figure 1-

### OPTIONAL GROUND INSTRUCTIONS

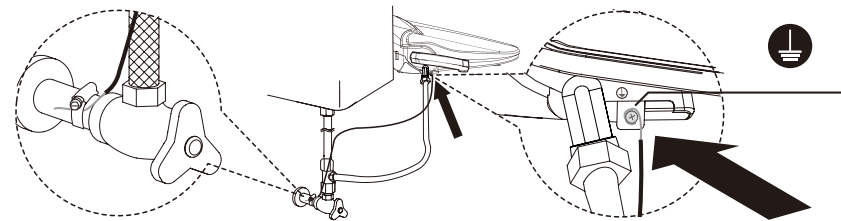



### DANGER

- **IMPROPER GROUNDING CAN RESULT IN A RISK OF ELECTRIC SHOCK.**  
Electric wiring has to be done in accordance with all local codes, or in the absence of local codes, with the National Electrical Codes.
- The use of an extension cord is not recommended or advised. If it is necessary to use an extension cord, use only a three-prong extension cord (one to one), and a three slot built-in GFCI receptacle that will accept the plug on this product. The marked rating of the extension cord should be equal to or greater than the electrical rating of the unit (10amp). Consult a qualified electrician or service person if you are not sure whether the unit is properly grounded.

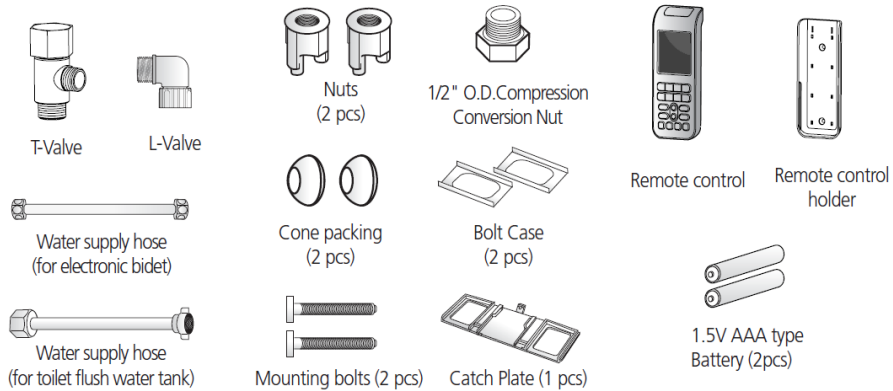
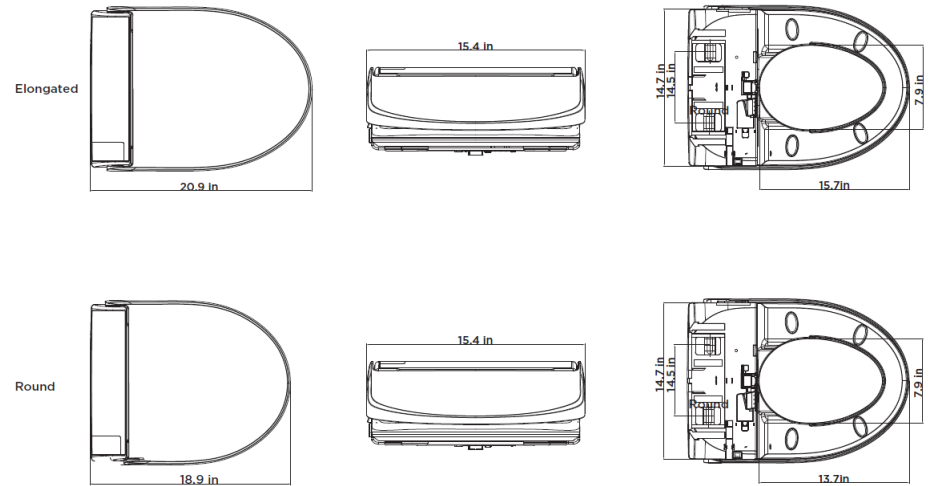
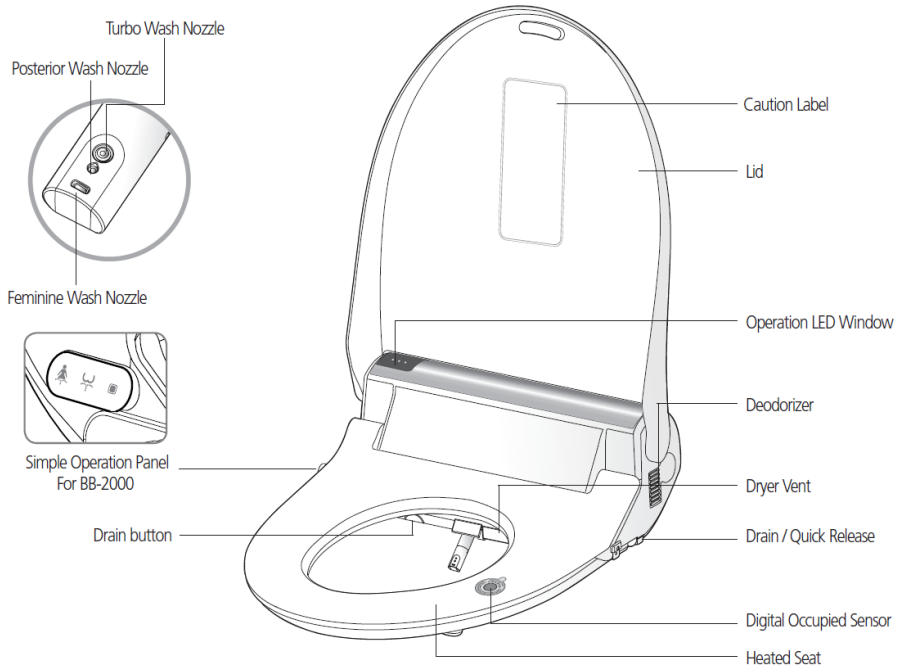

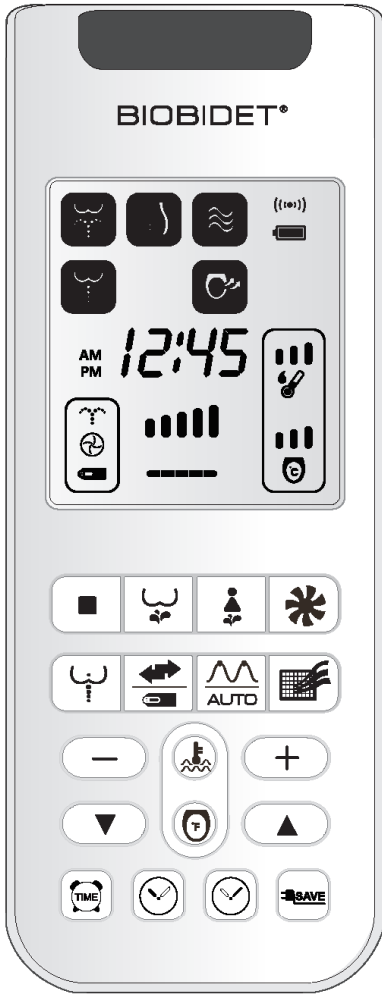

	Stop all operation.
	Posterior wash.
	Feminine wash.
	Dry washed area.
	VORTEX wash.
	When selected during wash function nozzle oscillates automatically for a wider wash.
	If move button is selected when user is not sitting on the seat, it operates nozzle shower function.
	When selected during wash function, it start massage wash.
	If massage function selected when user is not using wash functions, it automatically operates wash and dry function sequentially.
	When user sits on the seat, it automatically operates to deodorize. (Can select on/off)
	The water temperature can be adjusted up to 4 levels (off, low, middle, high).
	The seat temperature can be adjusted up to 4 levels (off, low, middle, high).
	Can set time in the remote control with hour(🕒) and minutes(🕒) buttons.
	If Economy mode is selected, seat temperature and water temperature will stay at 89.6°F.
	If this(🔋) symbol flashes, please change the battery in remote control.

DISPLAY



1	Posterior Wash	10	Set Seat Temperature
2	Feminine Wash	11	Heated Seat
3	Dry	12	Water Pressure
4	Turbo	13	Dry On / Off
5	Deodrant	14	Set Nozzle position
6	Remote signal intensity	15	Water pressure
7	battery life	16	Nozzle position
8	Set Water Temperature		
9	Heated Water		

OPERATION PANEL

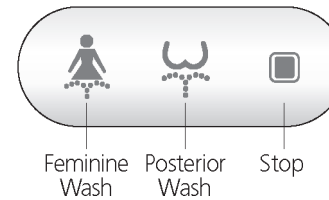

When you sit down on this product, sit in the center in order to activate the sensor. (If the unit's input water temperature is lower than 54°F, the water temperature could be lower than the above noted temperatures)



**CAUTION**

Please press the “off” or “low” button to reduce the seat temperature after using. Special precautions should be taken for children, those who cannot adjust the temperature, and those who have sensitive skin.

**DO NOT ALLOW CHILDREN TO USE THE TURBO WASH or VORTEX WASH FUNCTION! SUPERVISION IS STRONGLY RECOMMENDED FOR THE ELDERLY OR OTHER PERSONS THAT MAY HAVE LIMITATIONS IN BODY MOVEMENT, ILLNESS OR DISABILITIES.**

### 1. Check for Water Leaks

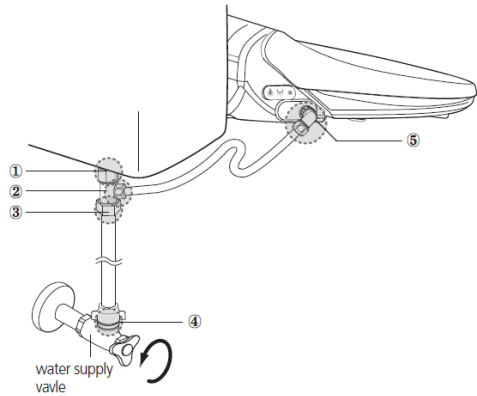

- Please turn on the water supply valve and check connected spots (1-5) for the leakage.

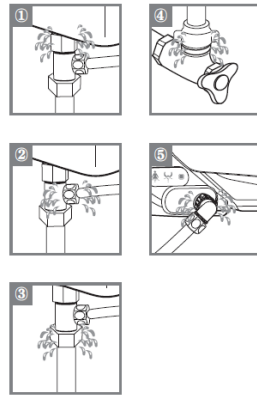

### 2. Preparation



- Please plug the power cord into AC120V power outlet.
- Plug the unit into the proper power source and the LED power light will start flashing.
- Wait until the LED power light stops flashing and becomes solid red.
- The water tank will be filled after pushing a “wash” (Posterior Wash, Feminine) button.
- When the water tank is filling the buzzer “Beeps” continuously.
- After the water tank is full the buzzer will end with “One Solid Beep”.

### 3. Sit On Seat

- When you sit down on the seat, the orange light in the LED window will light up
- When the digital sensor on the seat is activated, the operation LED window on the main unit will light “Occupied sensor” and simultaneously, the deodorizer fan will start to work. (BB-1700/ BB-2000 Models)

### 4. Stop

- Press this button to stop all operation.





**5. Posterior Wash**



1. Press "Posterior Wash". Automatically, the nozzle comes out and sprays warm water to posterior.
2. Additional functions during your Posterior Wash experience are available.

**6. Feminine Wash**



1. Press "Feminine Wash". Automatically, the nozzle comes out and sprays warm water to feminine area.
2. Additional functions during your Feminine Wash experience are available.

6. Press the "STOP" button when you feel your abdomen is full or wait until the "Turbo Wash" or "Vortex Wash" function stops, approximately 1 minute.
7. You will shortly feel the urge to push the water out of your colon, push the water and feces out as thoroughly as you can.
8. 6- Relax for a few minutes and be sure you feel your colon is empty and then use the "Posterior Wash" and "Air Dry" function to finish.

**7. Turbo Wash/Vortex Wash**



1. Press "Turbo Wash" or "Vortex Wash", the nozzle spray is more or focused to produce the effect of strong wash, to help stimulate bowel movement.
2. Press "Water pressure - High & Low button" to adjust the water pressure.
3. Press "Turbo Wash" or "Vortex Wash" continuously for 3 to 5 seconds. Automatically, the water nozzle comes out and sprays a warm stream of water to the posterior center of the rectum.
4. If necessary, adjust "Position" of water stream with the (<, >) buttons.
5. Press "Water pressure High & Low button" (+, -) to adjust the water pressure to your desired comfort.

**8. Warm Air Dryer**



1. Press "Dry", warm, dry air is gently directed to washed area for about 3 minutes.
2. You may adjust the warm air temp. by pressing High and Low (+, -) buttons.
3. This product memorizes the air temperature of prior use.

**9. Water Pressure Adjustment**



- After sitting down on the this product, the LED lamp for water pressure on the Power Control will light at third or middle level.
- Press high or low (+, -) to adjust the pressure of the water spray to your desired comfort level.



### 10. Warm Water/Seat Temperature Adjustment

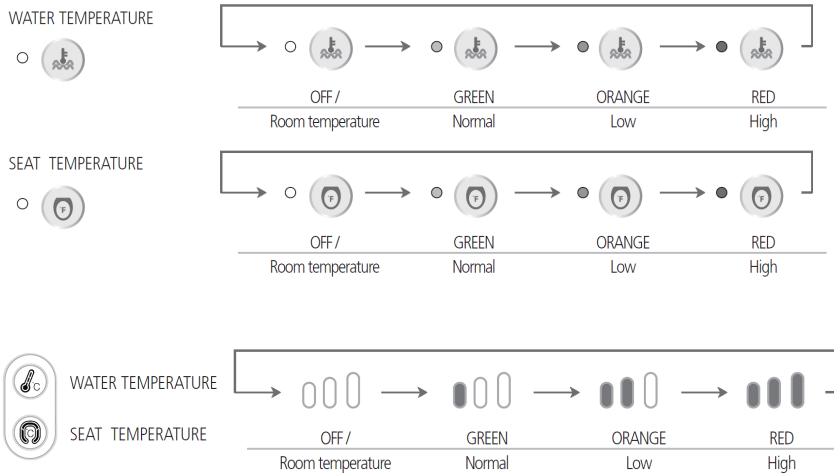

- The temperature of water and seat are adjustable to the desired level by pressing the “WATER” and “SEAT” button.

### 11. Deodorizer



- Deodorizer ON/Off (initial setting is Off)
- Press button for 3 seconds (press the button again for 3 seconds, the function is canceled.)
- After setting Deodorizer function, it is automatically activated when sensing the human body.
- Once used, the Deodorizer function automatically stops after 1 minute of operation.
- Deodorizer function stops while dryer is selected. After dryer function completes, deodorizer automatically is activated.



## 12. Oscillation (Nozzle Movement Function)

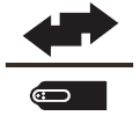

- When using Posterior or Feminine Washing functions, pressing the “MOVE” button will provide a short-motion, front to back oscillating spray for a much wider cleansing experience.
- You may change the position of the Oscillating spray by pressing the “MOVE” button again and “Front” or “Rear” buttons simultaneously.
- Push the “MOVE” button again and the oscillation motion will stop automatically.
- Auto-Setting of Oscillation Feature - You can set this function to automatically oscillate whenever the seat is occupied and the Posterior or Feminine washes are in operation.

1. Sit on this product. Press the “MOVE” button for 3 seconds or until you hear a single Chime.
  2. Sit on the this product and proceed with Posterior or Feminine Wash. In the automatic setting, you may still adjust the position of the Oscillating spray by pressing the “Front” or “Rear” buttons.
- Canceling the Automatic Oscillation function
3. Sit on this product. Press the “MOVE” button for 3 seconds or until you hear a double Chime.

## 13. Nozzle Position Adjustment

- Nozzle position is adjustable to the desired position by pressing “Front” or “Rear” (< , >) button from 1 to 5 positions. After using this product, the nozzle will return to position 3.

## 14. Massage (Rhythm Wash)



- When using the Posterior Wash or Feminine Wash functions, pressing the “MASSAGE” button will provide a pulsation spray.
  - You may change the pressure of the spray by pressing the “High” or “Low” (+, -) buttons.
  - Push the “MASSAGE” button again and the pulsating action will stop automatically.
  - Auto-Setting of Massage Feature
  - You can set this function to automatically pulsate whenever the seat is occupied and the Posterior or Feminine washes are in operation.
1. Sit on this product. Step 2: Press the “MASSAGE” button for 3 seconds or until you hear a single Chime.
  2. Sit on this product and proceed with Posterior or Feminine Wash. In the automatic setting, you may still adjust the pressure of the pulsating spray by pressing the “High” or “Low” (+, -) functions.
- Canceling the Automatic Oscillation function
3. Sit on this product. Press the “MASSAGE” button for 3 seconds or until you hear a double Chime.



**15. Auto Wash**

- If the “MASSAGE” function selected when user is not using wash functions, it automatically operates wash and dry function sequentially.
- Wash (30 Seconds) + Dryer (1 minute) then automatically stops.

**17. Night Light**



- Press “Stop” and “Temperature” remote buttons simultaneously until night light is turned on or off.

**16. Nozzle Shower**

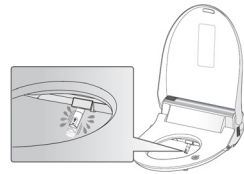

- Press “Move” button while seat is not occupied.
- Nozzle shower will initiate to clean nozzle and tip for about 20 seconds.
- Nozzle will automatically retract once finished.

**18. Economy (Energy Save Mode) **

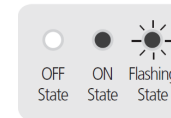
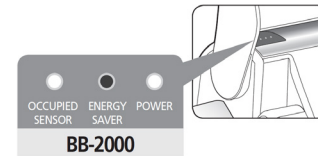

- Saver On/ Off
- When pressing the energy saver LED on the main unit will turn on. (press button again, the saver LED will turn off)
- Energy saver mode automatically maintains a water and seat temperature of 89.6°F (32°C).
- When using bidet in saver mode, it is turned to automatic saver.
- When you rise from the seat, it goes into saver mode.
- Seat temperature is maintained 32°C.

In energy saver mode, the seat heating temperature could appear to be lower than the actual temperature setting.

**OTHER ENERGY SAVING TIPS:**

- Keep seat cover closed when not in use to prevent heat from being lost.
- Keep temperature set to low.
- Unplug the power cord if you do not plan to use the unit for a long period of time.



**19. Nozzle Cleaning (Automatic & Manual)**

**Automatic**

- This product has an automatic nozzle self-cleaning function that cleans the nozzle before and after each use.

**Manual**

- Press the “Posterior” button on the Auxiliary Control panel on the side of the seat without occupying seat. The nozzle will fully extend. Gently clean the nozzle with a soft cloth or toothbrush.
- Press “Stop” button to retract nozzle to stand by mode.

**20. Selecting/Canceling Silent Mode**

- Beeping mode can be enabled or disabled.
- To select or cancel silent mode, press and hold down the “Stop” and “Massage” remote buttons simultaneously for approximately 3 seconds or until short beeps
- Single short beep - Silent mode has been canceled
- Double short beeps - Silent mode has been set
- The new setting will automatically be saved if no other buttons are pressed.



**CAUTION**

- Do not plug in before installation.
- If you need an electric power system or extension, please consult a qualified electrician.
- Please contact our service center (847-458-2334) when you want to reinstall the bidet product (move or replacement).

**2. Remove Existing Seat & Lid**



- Remove mounting bolts to release existing toilet seat from toilet.

**1. Turn Off Water**

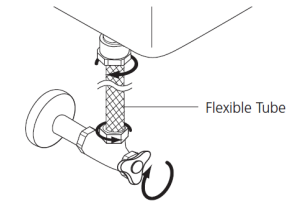

- Shut off the water supply shut off valve.
- Drain the toilet tank completely.
- Then remove the existing fill valve water supply hose.

**3. Connect T-Valve**

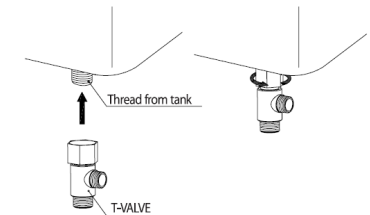

- Remove existing supply hose connected to the toilet tank. Make sure not to damage the water supply hose.
- Install T-Valve at the thread from tank.



## 4. Water Supply Hose

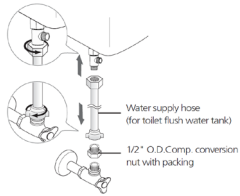

- Remove existing supply tube from fresh tank
- If your shut off valve is 1/2" O.D compression size, use supplied 1/2" conversion nut with packing as shown below.

## 5. Installation Catch Plate

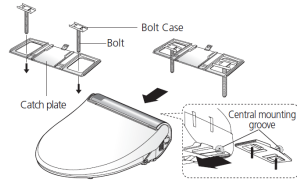

- Place the plate and guides over each mounting hole. Insert the mounting bolts through the plate and mounting holes.

## 7. Assembly

1. Slide this product onto the catch plate centering the unit with the guide arrows on the base.
2. You will hear a click once this product is securely mounted to the catch plate.
3. This product will feel a little loose on the toilet bowl. Adjust the fit from front to back and side to side for balance.
4. Tighten the nuts on both bolts securely.
5. Check for any water leaks.

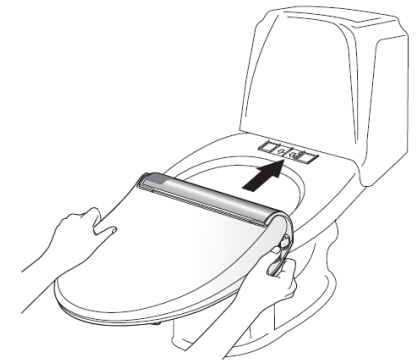

## 6. Bolt & Nut Assembly

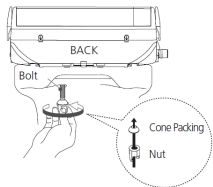

- Slide cone packing and washers onto the bolts then fasten to securely mount bidet seat to toilet.

## 8. Flexible Tube

- Connect the flexible tube from side of T-Valve to this product. Open the Angle Stop valve to fill water.
- Check for any water leaks.
- Customers should use the new hose set provided with the product. Do not use used set again.

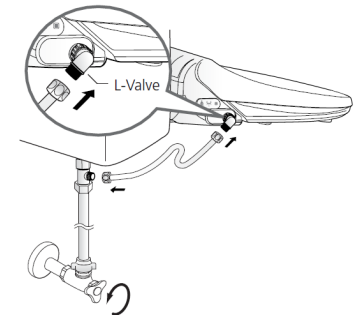



**9. Wireless Remote Mounting Guide**

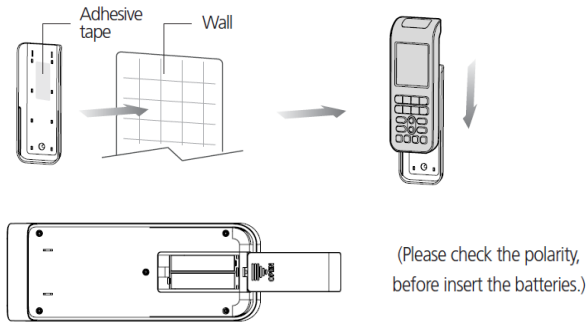

- Remove adhesive from back of bracket and place bracket where desired.
- Insert supplied batteries (1.5V AAA) and close battery cover.

**10. Nozzle Change**

**Nozzle Separation**

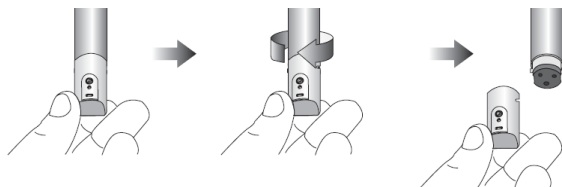

**Nozzle Combination**

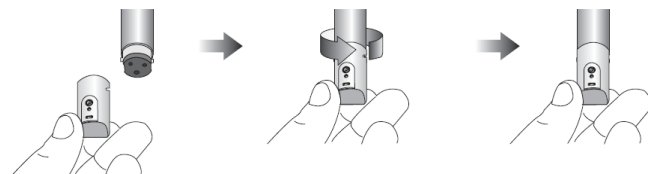

**Separation of Unit From Toilet Bowl**

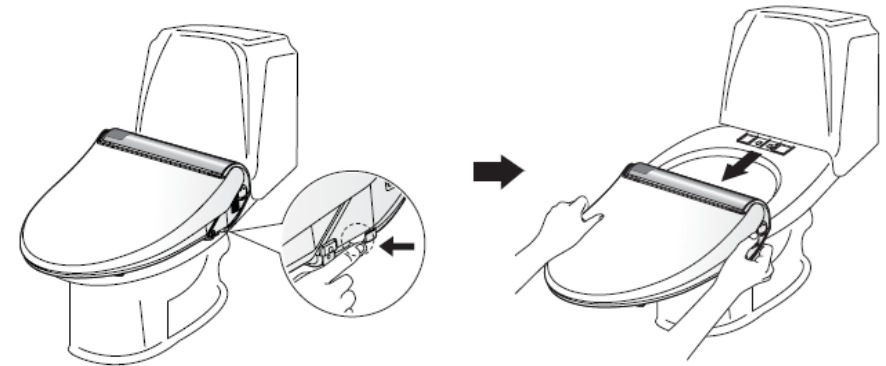

**DO NOT TURN UNIT UPSIDE DOWN**

1. Disconnect the power plug.
2. Close water supply shut-off valve.
3. Drain water from bidet seat using drainage as illustrated.
4. Remove bidet seat from toilet as illustrated.



## Cleaning The Nozzle

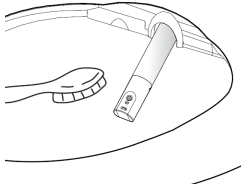

- When the “Posterior Wash” button is pressed for 3 seconds without occupying the seat, the nozzle can be cleaned with a soft toothbrush.
- After cleaning the nozzle, push the “Stop” button once again, and the nozzle retracts itself.

## Water Filter Maintenance

- Use of external water filter is only recommended in areas with known hard water issues. If a filter is used, it must be replaced every 3 months.
- This product is designed and intended for use exclusively with Bio Bidet Carbon & Iodine water filters. The purchase or use of any other water filter is not the responsibility of BBC Innovation LLC. As such, any use of non Carbon or Iodine water filters is prohibited and will void the warranty for those Bio Bidet products. Bio Bidet will not be responsible for any resulting damages or claims related to the misuse or distribution of non BioBidet Carbon & Iodine filters.

## Cleaning The Body Of Unit

- When you clean this product, do not use thinner, benzene or toilet bowl cleaner. It may cause damage to the surface of unit.
- Use a wet cloth when you clean this product.
- Do not spray water directly on to this product.
- When you clean this product, disconnect the power plug.

## Cleaning The Strainer

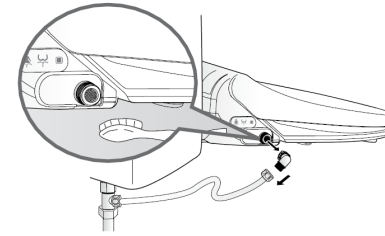

This product will not operate properly if the strainer is clogged. Please clean the strainer regularly.

1. Close the water shut off valve.
2. Flush the toilet to empty the water reservoir.
3. Unscrew the water hose nut.
4. Clean the strainer with a small brush or water
5. Re-screw the water hose nut.
6. Open the water shut off valve.





**Draining the Warm Water Tank in the Unit**



**Do not drink the drained water. Do not insert finger into the drain hole. Before draining, unplug the power cord and wait 30 minutes until the unit has cooled down.**

If you do not intend to use this product for 14 days or longer, Drain the water from this product's warm water tank.

1. Disconnect the power plug.
2. Close the water shut off valve.
3. Press the drain lever until the water is completely drained from water tank.
4. To re-supply water after draining, open the water shut off valve.

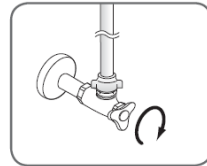

**Maintenance For Winter Season**

1. Check the power cord if it is plugged in or not.
2. Keep the water temperature on "Middle or High Level" to prevent water from freezing.
3. If you do not intend to use the unit for 14 days or longer, disconnect the power plug and drain the water.

Trouble	Cause	Remedy
<b>The washing water does not spray</b>	<ol style="list-style-type: none"> <li>1. The water tank is not filled.</li> <li>2. The shut off valve is closed.</li> <li>3. Freezing inside the main unit or the water supply pipe.</li> </ol>	<ol style="list-style-type: none"> <li>1. Wait about one minute.</li> <li>2. Press the desired washing button once again.</li> <li>3. Turn on the shut off valve to open.</li> <li>4. Heat the room (for about two hours). Operating the unit while parts are frozen will cause a malfunction.</li> </ol>
<b>The unit is not operating</b>	<ol style="list-style-type: none"> <li>1. Disconnected the power cord.</li> <li>2. The seat is not occupied.</li> <li>3. The battery of remote controller is exhausted.</li> </ol>	<ol style="list-style-type: none"> <li>1. Connect the power cord.</li> <li>2. Check the power supply system in your house.</li> <li>3. Occupy the seat (The unit has an occupied sensor).</li> <li>4. Replace the battery.</li> </ol>
<b>Water is leaking</b>	Check the water supply system	If water is leaking from the main unit, call the service center or the place you purchased unit.
<b>The washing water pressure is weak</b>	<ol style="list-style-type: none"> <li>1. The water pressure level is set to "LOW".</li> <li>2. The strainer is clogged.</li> </ol>	<ol style="list-style-type: none"> <li>1. Set the water pressure to "HIGH"</li> <li>2. Clean the strainer.</li> </ol>
<b>The washing water is not warm</b>	<ol style="list-style-type: none"> <li>1. The water temperature is set to "LOW"</li> <li>2. Continuous operation has depleted the supply of warm water.</li> </ol>	<ol style="list-style-type: none"> <li>1. Set the water temperature to "HIGH"</li> <li>2. Wait about three minutes.</li> </ol>
<b>The seat and dryer is not warm</b>	The seat & dryer temperature is set to "LOW"	Set the seat & dryer temperature to "HIGH"



Specifications		BB-2000
<b>Power Rating</b>		America or Canada: 120Vac, 60Hz, 1400W
<b>Water Inlet Type</b>	<b>Type</b>	Direct Inlet flow type
	<b>Water inlet pressure</b>	0.04 - 0.74MPa(0.4 - 7.5 kgf/cm)
<b>Power Cord</b>		1.2m (4 feet): AMERICA
<b>Wash Device</b>	<b>Posterior Wash</b>	Max. 0.7l/min ( Max. 0.185 GPM )
	<b>Feminine Wash</b>	Max. 0.7l/min ( Max. 0.185 GPM )
	<b>Water Pressure Adjustable</b>	5 Levels
	<b>Warm Water Temperature</b>	Room Temp - Low, Normal, High
	<b>Heater</b>	1340 W
	<b>Safety Devices</b>	Thermal fuse, Thermal switch, Float switch
<b>Heated Seat</b>	<b>Temperature</b>	Room Temp - Low, Normal, High
	<b>Heater</b>	55 W
	<b>Safety Device</b>	Thermal fuse
<b>Warm Air Dryer Device</b>	<b>Adjustable Dry Temp (Room Temp 55°C)</b>	○
	<b>Heated (250W)</b>	○
	<b>Safety Device (Thermal fuse, bi metal)</b>	○
<b>Turbo&amp; Vortex Function</b>		○
<b>Deodorizer</b>		○
<b>Remote Control</b>		○
<b>Inlet Water Temp.</b>		3°C- 35°C ( 37.4°F - 95°F )
<b>Ambient Temp.</b>		3°C- 40°C ( 37.4°F - 104°F )
<b>Dimension</b>		W : 392mm / L : 531mm / H : 152mm
<b>Weight (kg)</b>		4.8kg

**3 YEAR FULL COVERAGE WARRANTY**

BBC Innovation LLC warranty its product to be free from manufacturing defects under normal use and service for a period of three (3) years from originaldate of purchase.

This warranty is extended only to the ORIGINAL PURCHASER.

- BBC Innovation LLC's obligations under this warranty are limited to repair or replacement, at BBC Innovation LLC's option, of products or parts found to be defective, provided that such products were properly installed and used in accordance with instructions.
- BBC Innovation LLC reserves the right to make such inspections as may be necessary in order to determine the cause of the defect.
- BBC Innovation LLC will not charge for labor or parts in connection with warranty repairs or replacements.
- BBC Innovation LLC is not responsible for the cost of removal, return and/or re installation of products.

This warranty does not apply to the following items:

- Damage or loss sustained in a natural calamity such as fire, earthquake, flood, thunder electrical storm, etc.
- Damage or loss resulting from any unreasonable use, misuse, abuse, negligence, or improper maintenance of the product.
- Damage or loss resulting from removal, improper repair, or modification of the product.
- Damage or loss resulting from sediments or foreign matter contained in a water system.
- Damage or loss resulting from improper installation or from installation of a unit in a harsh and/or hazardous environment.

This warranty gives you specific legal rights. You may have other rights which vary from state to state. To obtain warranty repair service under this warranty, you must take the product or deliver it prepaid to a BBC Innovation LLC service facility together with a letter stating the problem, or contact a BBC Innovation LLC distributor or products service contractor, or



write directly to  
BBC Innovation LLC, 7900 Illinois Rte 31, Crystal Lake, IL 60014.

This written warranty is the only warranty made by BBC Innovation LLC. Repair or replacement as provided under this warranty shall be the exclusive remedy available to the purchaser. BBC Innovation LLC shall not be responsible for loss of the product or for other incidental, special or consequential damages or expenses incurred by the purchaser, or for labor or other costs due to installation or removal, or costs of repairs by others, or for any other expense not specifically stated above. Except to the extent prohibited by applicable law, any implied warranties, including that of merchantability or fitness for use, are expressly limited to the duration this warranty. Some states do not allow limitations on how long an implied warranty lasts, or the exclusion or limitation of incidental or consequential damages, so the above limitation and exclusion may not apply to you.

**Warning!** BBC Innovation LLC shall not be responsible or liable for any failure of, or damage to, this plumbing product or product component caused by either chloramines in the treatment of public water supply or in-tank bowl cleaners containing chlorine (calcium hypochlorite).

**Note:** The use of high concentration of chlorine or chlorine related products can seriously damage the fittings. This damage can cause leakage and serious property damage.



**WARNING - Changes or modifications not expressly approved by the manufacturer could void the user's authority to operate the equipment.**

**Note:** The manufacturer is not responsible for any Radio or TV interference caused by unauthorized modifications to this equipment. Such modifications could void the user's authority to operate the equipment.

This equipment has been tested and found to comply with the limits for a Class B digital device, pursuant to part 15 of the FCC Rules. These limits are designed to provide reasonable protection against harmful interference in a residential installation. This equipment generates, uses and can radiate radio frequency energy and, if not installed and used in accordance with the instructions, may cause harmful interference to radio communications. However, there is no guarantee that interference will not occur in a particular installation. If this equipment does cause harmful interference to radio or television reception, which can be determined by turning the equipment off and on, the user is encouraged to try to correct the interference by one more of the following measures:

- Reorient or relocate the receiving antenna.
- Increase the separation between the equipment and receiver.
- Connect the equipment into an outlet on a circuit different from that to which the receiver is connected.
- Consult the dealer or an experienced radio/TV technician for help.

# Thank You



Technical Support/Customer Service  
7900 S Route 31 Crystal Lake, IL 60014  
T: 847.458.2334  
U.S. TOLL FREE: 877.339.5214

[support@biobidet.com](mailto:support@biobidet.com)  
[www.biobidet.com](http://www.biobidet.com)