

JACKBOARD®

The construction board system for creative bathroom design.

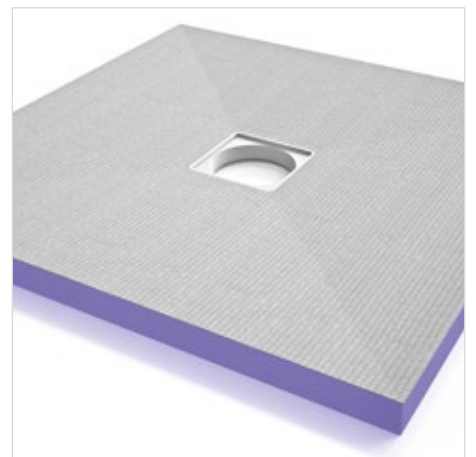

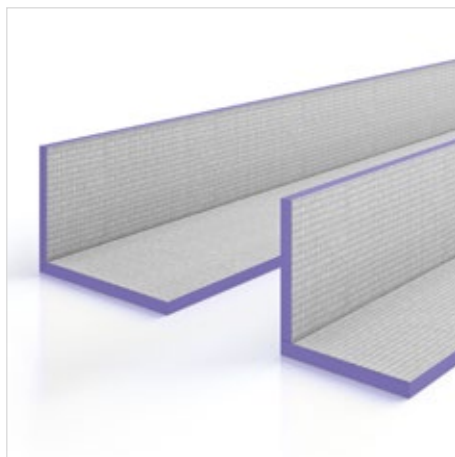
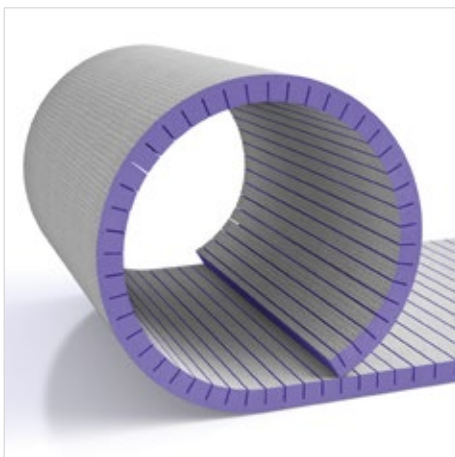
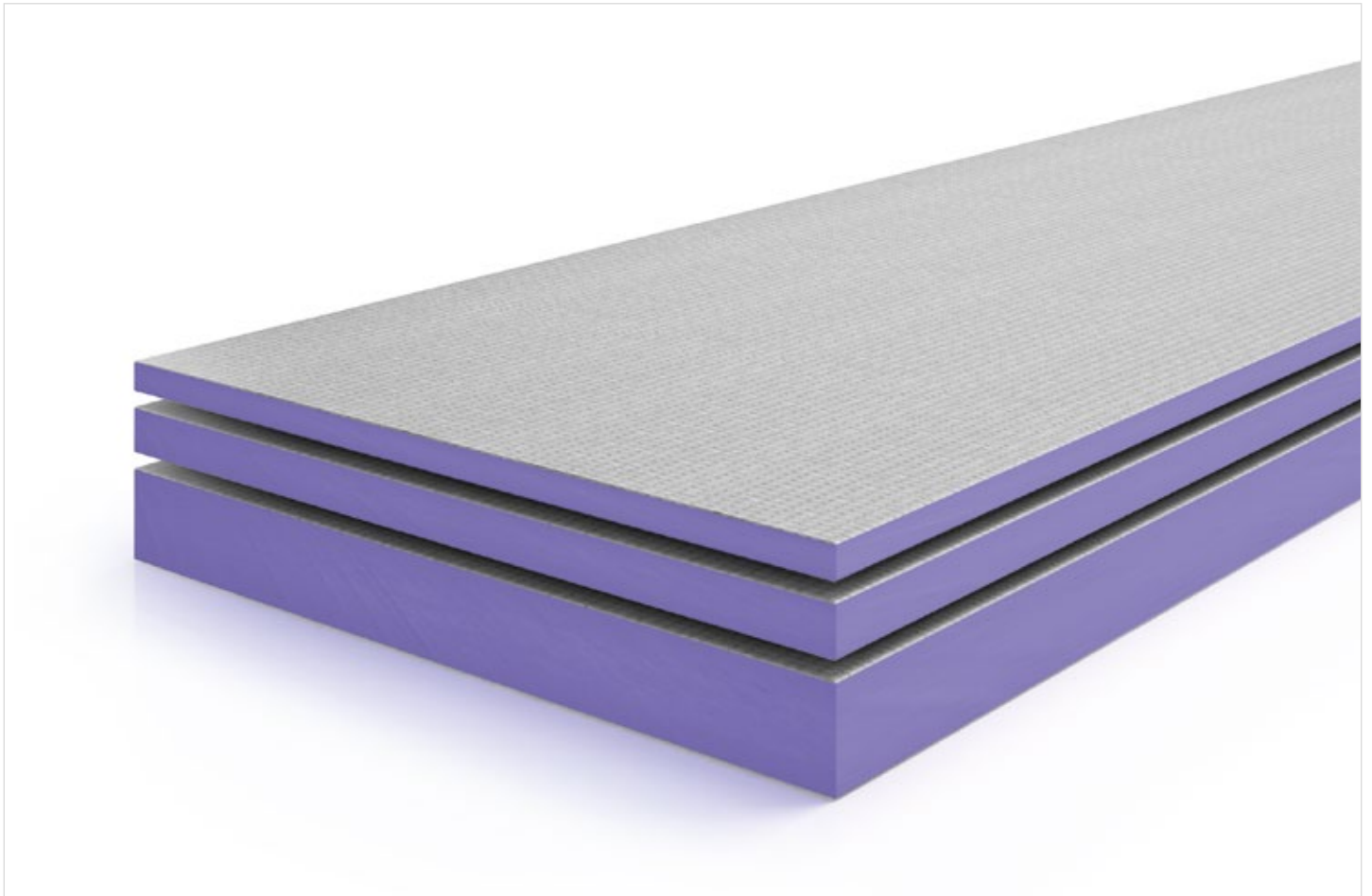
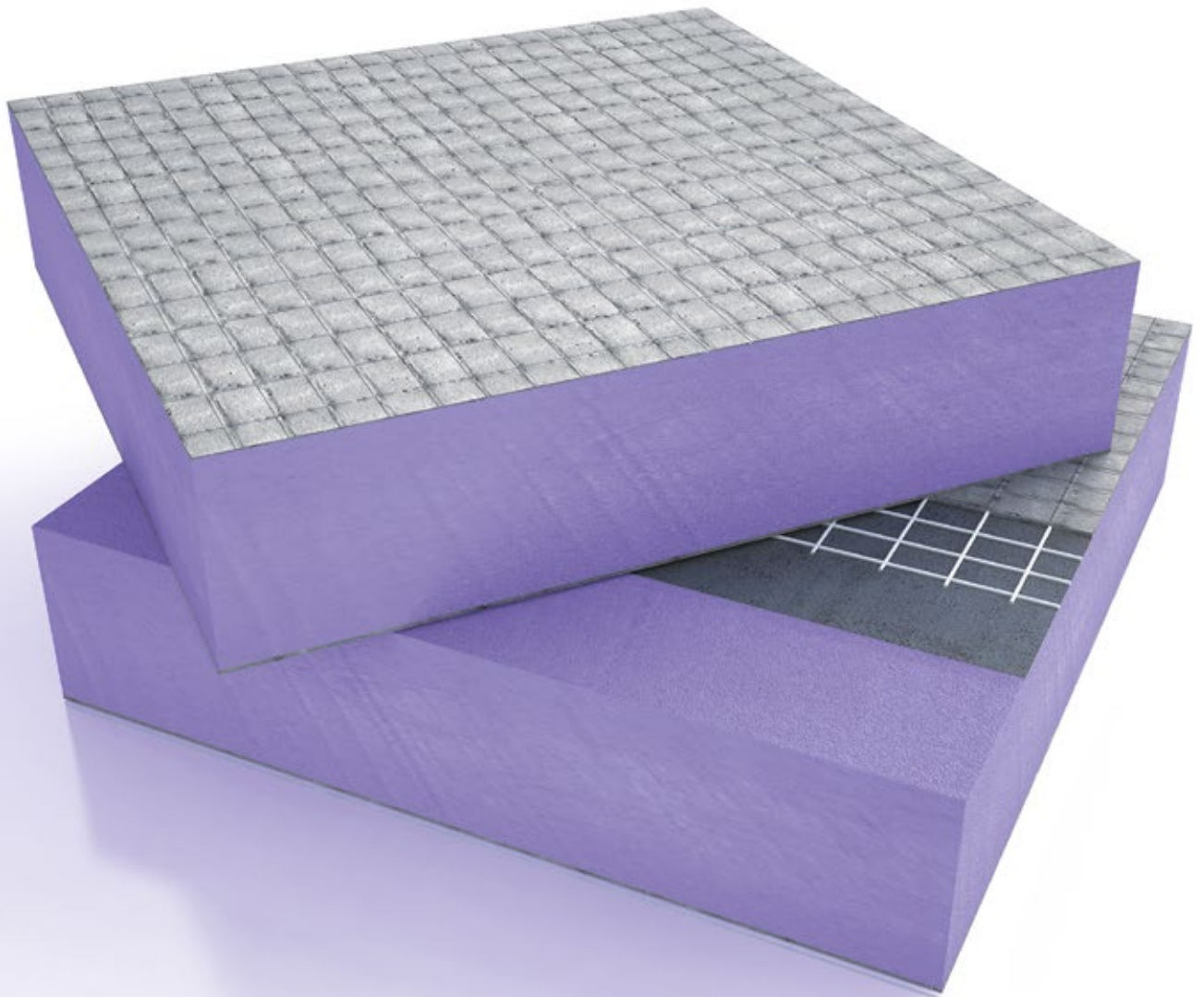

Easy to work with



Can be covered immediately with tiles, filler or plaster



Water repellent



Low weight
approx. 3-6 kg/m²



Optimum insulation properties
 $\lambda_p=0,034 \text{ W/(m}\cdot\text{K)}$



High compressive strength
> 300 kPa



For rooms exposed to high levels of moisture
(Wear class A1 and A2)

Thanks to their extruded polystyrene foam core and the special coating on both sides, the JACKOBOARD® construction boards are the ideal base for plaster and tile. The surfaces of the JACKOBOARD® system provide a strong primer and can be used on virtually any substrate. At the same time, they are water repellent, thermally insulating, light and sturdy.



JACKOBOARD®

The construction board system
for creative bathroom design.

Table of contents

Construction board system

Plano	04
Plano Premium	04
Plano NF	05
Canto	05
Canto Premium	06
Flexo	06
Flexo-Plus	07
Wabo	07

Bathroom furniture self assembly set

Sabo self assembly set	08
Vanity	08
Modula D 800	09
Modula D 1600	09
Modula R 600	09
Modula R 300	09

Shower elements

Aqua	10-12
Aqua Flat	12
Aqua Solid Premium	12
Aqua Reno	13
Aqua Base	13

Aqua drain systems	14
Stainless steel grates	15
Nova tileable drain cover	15
Aqua Line pro	16
Aqua Line pro drain systems	16
Aqua Line Profile	17
Aqua Delta	17
Aqua Spiral	18
Aqua Circle	19
Aqua Panel	19

Accessories

Sealing set	20
BOARD-FIX® adhesive and sealing agent	20
Assembly adhesive	20
Collars	21
Glass fibre tape	21
Sealing tape	21
4 E corners	21
Glass fibre tape	22
Construction board disks	22
Anchor	23
Metall disk plugs	23

Construction board system	24-25
Technical specifications	26-27

Valid from July 2017

This document replaces all previous versions and editions. All deliveries are governed exclusively by our General Terms and Conditions of Sale and Supply and by our Installation Instructions, in both cases as amended at the time of ordering (available on the internet at www.jackon-insulation.com). All prices apply to entire packaging units and are exclusive of statutory VAT. Please observe our minimum order value. Deliveries exclude unloading.

Construction board system

JACKOBOARD® Plano

- Construction board for interior architecture (wall, pipe and bath tub panelling, sink units, shelves etc.)
- Special coating on both sides
- Can be covered directly with tiles, plaster or render



Art. no.	EAN code	Thickness mm	Panel dim. mm	Pack content boards	Pack content m ²
4502263	40 25345 02263 6	4	1300 x 600	140	109,20
4513022	40 25345 13022 5	6	1300 x 600	140	109,20
4500211	40 25345 00211 9	10	1300 x 600	100	78,00
4502334*	40 25345 02334 3	12,5	1300 x 600	100	78,00
4500210	40 25345 00210 2	10	2600 x 600	50	78,00
4504089*	40 25345 04089 0	12,5	2600 x 600	50	78,00
4500212	40 25345 00212 6	20	2600 x 600	50	78,00
4513032	40 25345 13032 4	30	2600 x 600	36	56,16
4500185	40 25345 00185 3	40	2600 x 600	36	56,16
4513052	40 25345 13052 2	50	2600 x 600	26	40,56
4502264	40 25345 02264 3	60	2600 x 600	18	28,08
4502265	40 25345 02265 0	80	2600 x 600	16	24,96
4505060*	40 25345 05060 8	10	2600 x 900	50	117,00
4505061*	40 25345 05061 5	12,5	2600 x 900	40	93,60
4505062	40 25345 05062 2	20	2600 x 900	25	58,50
4504751	40 25345 04751 6	50	2600 x 900	16	37,44

*on request

JACKOBOARD® Plano Premium

- General purpose construction board for interior use
- Special non-woven coating for extra smooth finish
- Can be painted, wallpapered, plastered or tiled
- Taper edge to facilitate taped joints



Art. no.	EAN code	Thickness mm	Panel dim. mm	Pack content boards	Pack content m ²
4513126	40 25345 10254 3	10*	1300 x 600	84	65.52
4513127	40 25345 10255 0	12.5	1300 x 600	70	54.60
4513128	40 25345 10256 7	20	1300 x 600	84	65.52
4513129	40 25345 10257 4	30	1300 x 600	56	43.68
4513130	40 25345 10258 1	50	1300 x 600	34	26.52
4513131	40 25345 10259 8	12.5	2600 x 600	70	109.20
4513132	40 25345 10260 4	20	2600 x 600	84	131.04
4513133	40 25345 10261 1	30	2600 x 600	65	87.36
4513134	40 25345 10262 8	50	2600 x 600	34	53.04

*10 mm without tapered edge

Construction board system



JACKOBOARD® Plano NF

Plano NF-1

Art. no.	EAN code	Thickness mm	Panel dim. mm	Pack content boards	Pack content m ²
4509231	40 25345 07796 4	50	2600 x 600	26	40,56
4509232	40 25345 07797 1	80	2600 x 600	16	24,96

Plano NF-2

Art. no.	EAN code	Thickness mm	Panel dim. mm	Pack content boards	Pack content m ²
4509233	40 25345 07798 8	50	2600 x 600	26	40,56
4509234	40 25345 07799 5	80	2600 x 600	16	24,96

Plano NF-3

Art. no.	EAN code	Thickness mm	Panel dim. mm	Pack content boards	Pack content m ²
4509235	40 25345 07800 8	50	2600 x 600	26	40,56
4509236	40 25345 07801 5	80	2600 x 600	16	24,96

- Construction board with tongue and groove system
- Simple and sturdy connection of construction board joints for various applications
- Perfectly flat butt area
- Clean-cut corners
- Supplied complete with fillet jointing pieces 1300 x 37 x 6 mm
- Special coating on both sides
- Can be covered directly with tiles, plaster or render

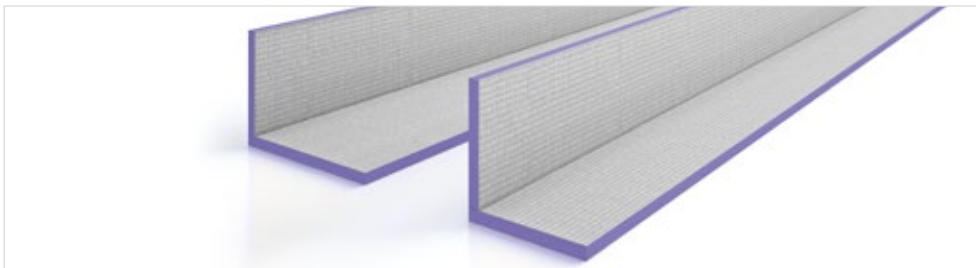

JACKOBOARD® Canto

Art. no.	EAN code	Thickness mm	Length mm	Dimensions mm	Pack content pcs.
4500043	40 25345 00043 6	20	2600	150 x 150	60
4500044	40 25345 00044 3	20	2600	200 x 200	40
4500009	40 25345 00009 2	20	2600	300 x 300	40
4500024	40 25345 00024 5	20	2600	400 x 200	40

- Special construction element for angles and corners and to cover pipes
- Special coating on both sides
- Can be supplied in U shape on request
- Can be covered directly with tiles, plaster or render

Construction board system

JACKOBOARD® Canto Premium

- Angle element for paint and tile applications
- Non-woven coating on both sides
- Can be cut to any dimensions
- Surface for tiles, plasters, fillers, wallpapers and paints

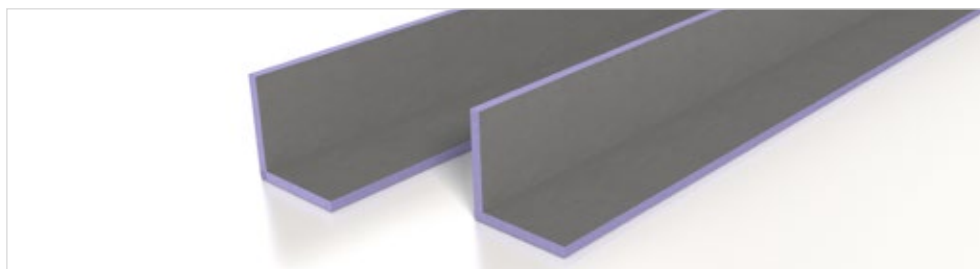

Art. no.	EAN code	Thickness mm	Length mm	Dimensions mm	Pack content pcs.
4511994*	40 25345 09661 3	20	2600	150 x 150	60
4511995	40 25345 09662 0	20	2600	200 x 200	40
4511996*	40 25345 09663 7	20	2600	300 x 300	40
4511997*	40 25345 09664 4	20	2600	200 x 400	40

* on request

JACKOBOARD® Flexo

- Construction element for creative interior architecture
- Differently rounded finishes possible
- Can be covered directly with tiles, plaster or render
- Single-sided slotted surface
- Distance between slots 30 mm
- Smallest bending radius 240 mm (inner), Thickness 30 mm
- Smallest bending radius 480 mm (inner), Thickness 50 mm

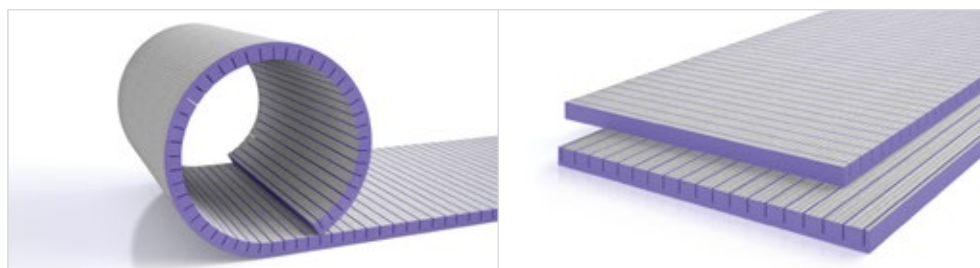

Art. no.	EAN code	Thickness mm	Panel dim. mm	Version	Pack content boards	Pack content m ²
4502335	40 25345 02335 0	30	1300 x 600	crossw. slotted	2	1,56
4502362	40 25345 02362 6	30	2600 x 600	lengthw. slotted	2	3,12
4502929	40 25345 02929 1	50	1300 x 600	crossw. slotted	2	1,56
4502928	40 25345 02928 4	50	2600 x 600	lengthw. slotted	2	3,12

Construction board system

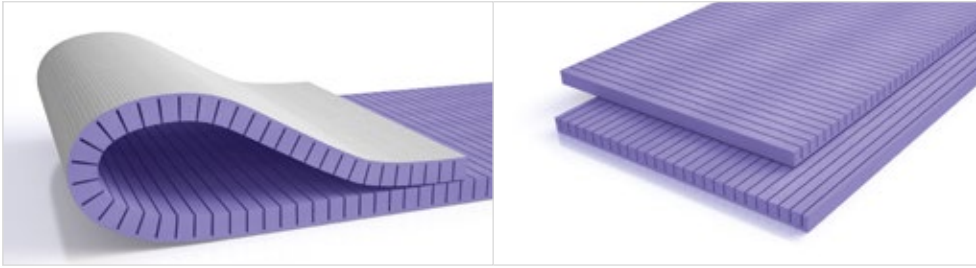

JACKOBOARD® Flexo-Plus

Art. no.	EAN code	Thickness mm	Panel dim. mm	Version	Pack content boards	Pack content m ²
4507938	40 25345 06840 5	30	1300 x 600	crossw. slotted	2	1,56
4507939	40 25345 06841 2	30	2600 x 600	lengthw. slotted	2	3,12

- Construction board for the creation of the widest possible variety of curves
- With a single-sided slotted surface
- Distance between slots 15 mm
- Specifically for small radii
- Smallest bending radius 90 mm (inner)
- Single-sided coating
- Can be covered directly with tiles, plaster or render

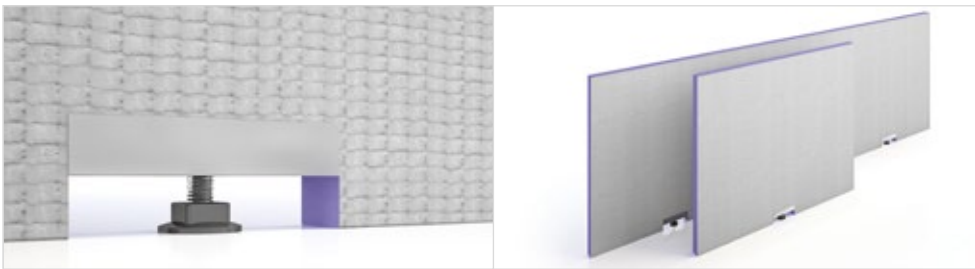

JACKOBOARD® Wabo

Art. no.	EAN code	Thickness mm	Panel dim. mm	Pack content
4500148	40 25345 00148 8	30	1770 x 600	1,06 m ² /board with 30 boards = 31,8 m ² /pallet
4500032	40 25345 00032 0	30	2100 x 600	1,26 m ² /board with 30 boards = 37,8 m ² /pallet
4500103	40 25345 00103 7	30	730 x 600	0,44 m ² /board with 30 boards = 13,2 m ² /pallet
4500117	40 25345 00117 4	30	900 x 300	0,27 m ² /board with 30 boards = 8,1 m ² /pallet

- Bath panel for bathtub panelling
- Easy to install
- Special coating on both sides
- Including adjustable feet
- Can be covered directly with tiles, plaster or render

Bathroom furniture self assembly set

JACKOBOARD® Sabo self assembly set

- Assembly kit for cladding WC wall elements
- 2-part construction element with holes for installation of standard toilets, 10 self-cutting drilling-screws and 10 construction board disks inclusive
- Special coating on both sides
- High compressive strength
- Can be covered directly with tiles

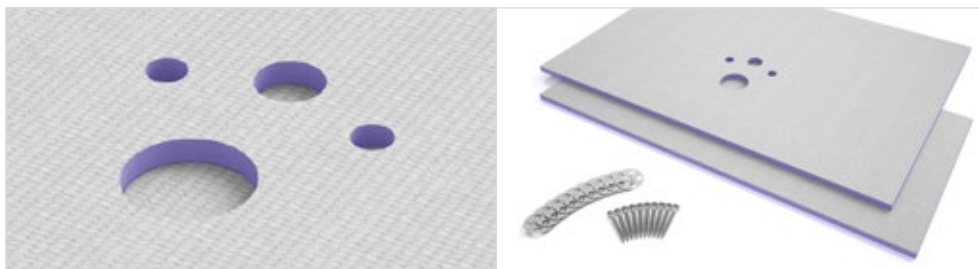

Art. no.	EAN code	Thickness mm	Panel dim. mm	Pack content
4508472	40 25345 07242 6	20	1300 x 900 1300 x 600	1

JACKOBOARD® Vanity

- Tileable designer washbasin for barrierfree bathrooms and spa facilities
- Made from extruded rigid polystyrene foam coated with special mortar with fibre glass weave
- Basin cutout with 3 fall surfaces
- With integrated moulded parts for mounting standard taps and drains
- Barrier-free in accordance with DIN 18040 parts 1 and 2
- Incl. 2 solid wall brackets made of steel to create an impression of free floating

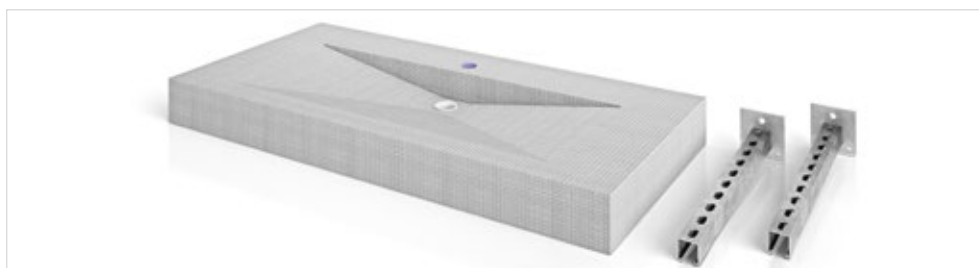

Art. no.	EAN code	Thickness mm	Dimensions mm	Pack content
4510565	40 25345 08690 4	110	1200 x 550	1

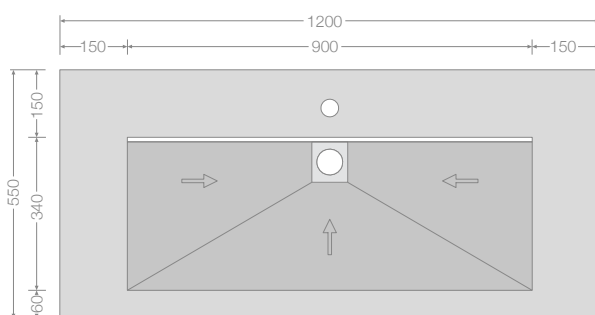

Construction board system

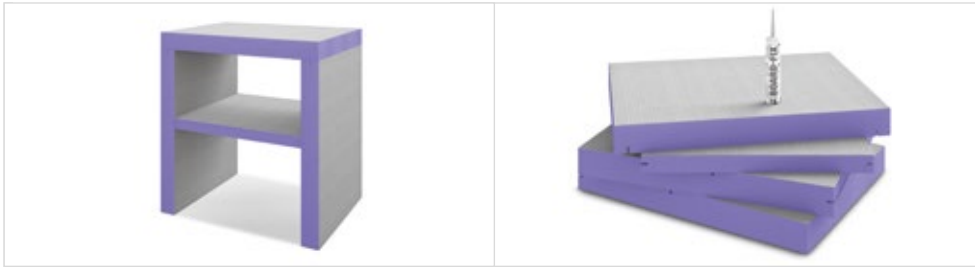

Art. no.	EAN code	Width mm	Depth mm	Height mm	Pack content
4506336	40 25345 05770 6	800	600	850	1

Special sizes available on request

JACKOBOARD® Modula D 800

- Assembly kit for single washstand consists of: 2 side walls and 1 top, 80 mm thick, 1 centre shelf, 50 mm thick, special adhesive, screws, mounting board, assembly instructions

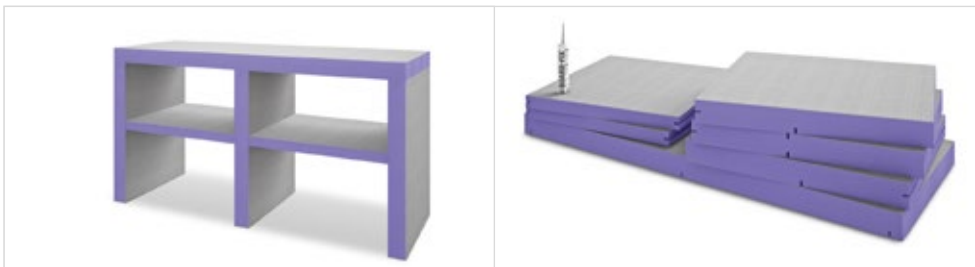

Art. no.	EAN code	Width mm	Depth mm	Height mm	Pack content
4506335	40 25345 05769 0	1600	600	850	1

Special sizes available on request

JACKOBOARD® Modula D 1600

- Assembly kit for double washstand consists of: 2 side walls, 1 centre wall and 1 top, 80 mm thick, 2 centre shelves, 50 mm thick, special adhesive, screws, mounting board, assembly instructions



Art. no.	EAN code	Width mm	Depth mm	Height mm	Pack content
4506337	40 25345 05771 3	600	600	2125	1

Special sizes available on request

JACKOBOARD® Modula R 600

- Assembly kit for shelf unit consists of: 2 side walls and 4 shelves, 50 mm thick, 1 shelf, 80 mm thick, special adhesive, screws, mounting board, assembly instruction3



Art. no.	EAN code	Width mm	Depth mm	Height mm	Pack content
4506338	40 25345 05772 0	600	300	2125	1

Special sizes available on request

JACKOBOARD® Modula R 300

- Assembly kit for shelf unit consists of: 2 side walls and 5 shelves, 50 mm thick, special adhesive, screws, mounting board, assembly instructions

Shower elements

JACKOBOARD® Aqua

- Extruded polystyrene foam shower element with special coating on both sides
- For barrier-free showering
- Can be tiled immediately
- Incorporated fall
- Sealed drain flange
- Wheelchair-accessible
- Complete with general building code test certificate (abP)
- Choice of different drainage systems (see page 14)

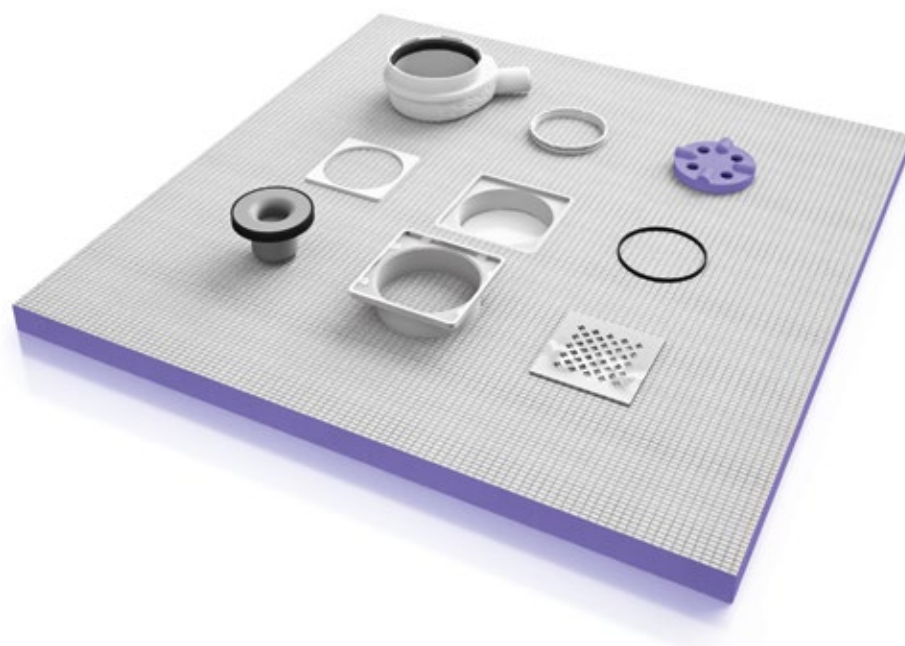

Special dimensions:

In addition to the standard sizes, JACKOBOARD® Aqua is also available in a wide range of made-to-measure sizes and shapes on request.



JACKOBOARD® Aqua central drain

Order the drain separately (p. 14)

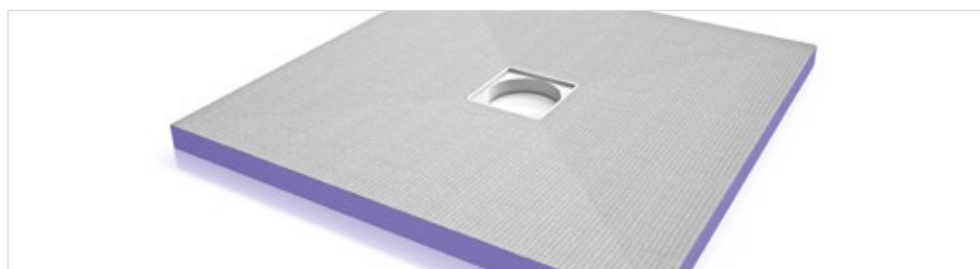

Art. no.	EAN code	Thickness mm	Panel dim. mm	Pack content
4512087	40 25345 09725 2	40	900 x 900	1
4512088	40 25345 09726 9	40	1000 x 1000	1
4512090	40 25345 09728 3	40	1200 x 1200	1
4512131	40 25345 09751 1	40	1500 x 1500	1
4512089	40 25345 09727 6	40	1200 x 900	1
4512091	40 25345 09729 0	40	1800 x 900	1

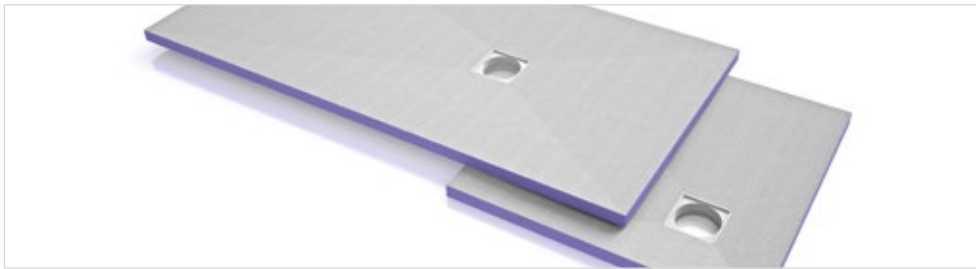

JACKOBOARD®
Aqua offset drain

Order the drain separately (p. 14)

Art. no.	EAN code	Thickness mm	Panel dim. mm	Drain centre from the edge	Pack content
4512092	40 25345 09730 6	40	900 x 900	250 / 250	1
4512093	40 25345 09731 3	40	1000 x 1000	250 / 250	1
4512095	40 25345 09733 7	40	1200 x 1200	350 / 350	1
4512094	40 25345 09732 0	40	1200 x 900	250 / 450	1
4512096	40 25345 09734 4	40	1400 x 900	450 / 450	1
4512097	40 25345 09735 1	40	1500 x 900	450 / 450	1
4512098	40 25345 09736 8	40	1800 x 900	650 / 450	1
4512099	40 25345 09737 5	50	1800 x 900	450 / 450	1
4512100	40 25345 09738 2	50	2000 x 1000	500 / 500	1

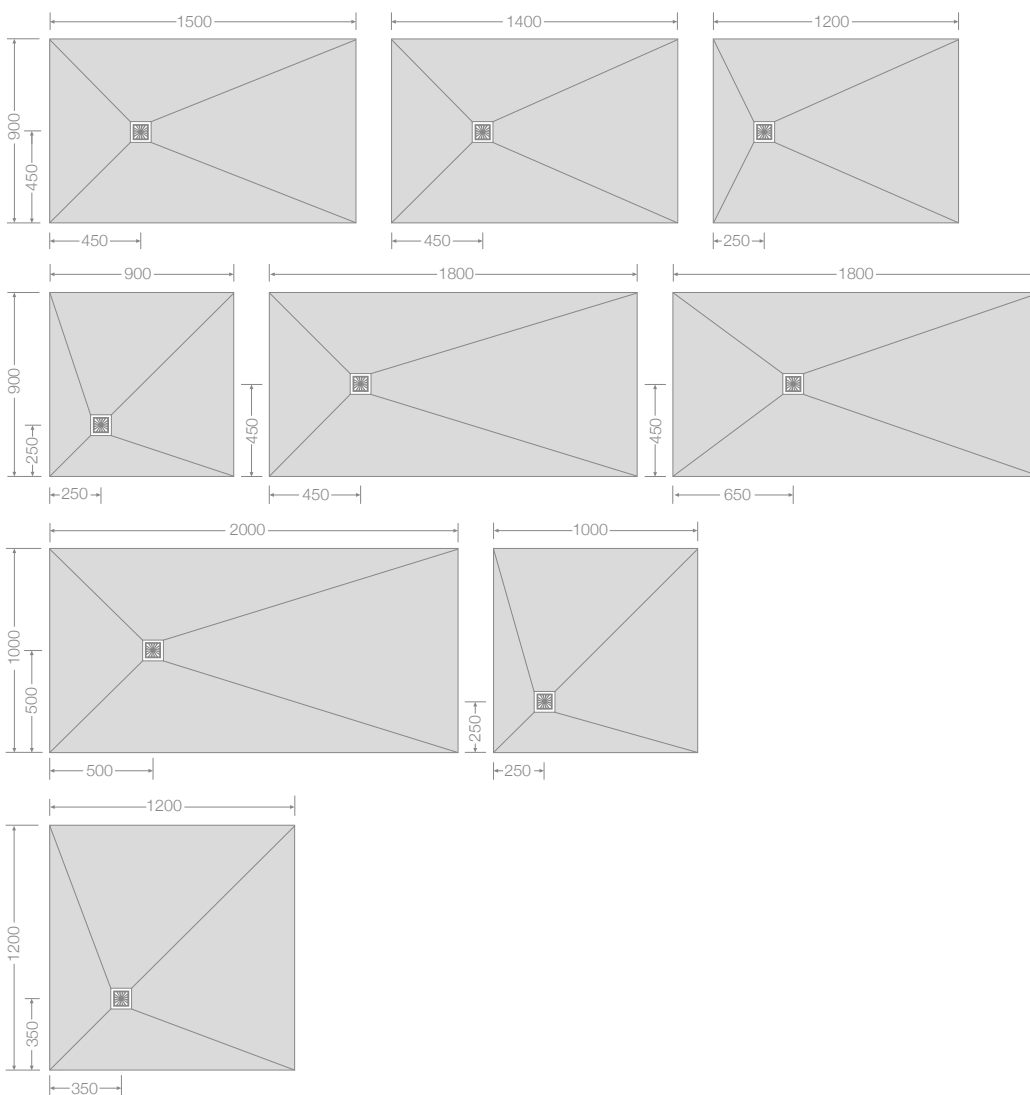

Shower elements

JACKOBOARD® Aqua quadrant, offset drain

Order the drain separately (p. 14)



Art. no.	EAN code	Thickness mm	Panel dim. mm	Drain centre from the edge	Pack content
4512122	40 25345 09747 4	40	900 x 900	250 / 250	1

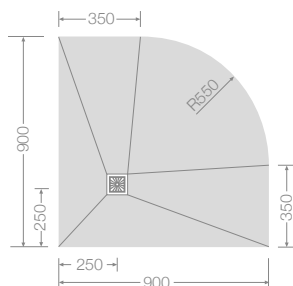

JACKOBOARD® Aqua Flat central drain

- Extremely flat version, just 20 mm thick
- Specially developed for suspended timber floors

Order the drain separately (p. 14)



Art. no.	EAN code	Thickness mm	Panel dim. mm	Pack content
4512101	40 25345 09739 9	20	900 x 900	1
4512102	40 25345 09740 5	20	1200 x 900	1
4512103	40 25345 09741 2	20	1200 x 1200	1

Special dimensions available on request

JACKOBOARD® Aqua Solid *Premium* central drain

- Shower element with a special highly compression proof coating
- No restrictions regarding tile size
- Wheelchair-accessible
- Incorporated fall
- Can be tiled immediately

Order the drain separately (p. 14)

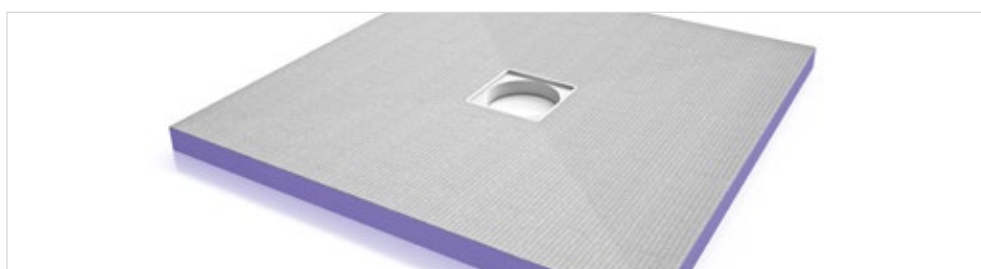

Art. no.	EAN code	Thickness mm	Panel dim. mm	Pack content
4512267	40 25345 09798 6	40	900 x 900	1
4512268	40 25345 09799 3	40	1400 x 900	1
4512269	40 25345 09800 6	40	1800 x 900	1

Special dimensions available on request

Shower elements

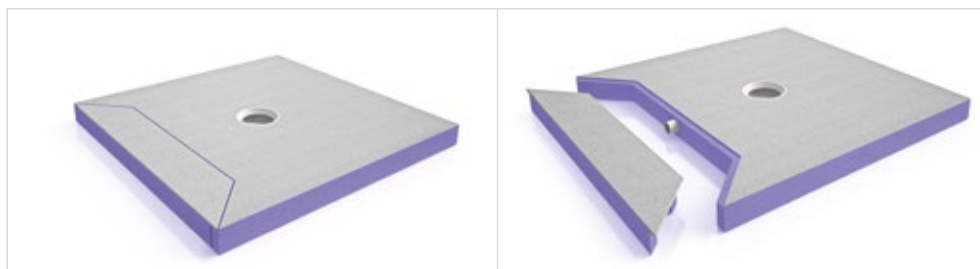

Art. no.	EAN code	Thickness mm	Panel dim. mm	Drain centre from the edge	Pack content
4512256	40 25345 09790 0	65	900 x 900	450 / 450	1
4512257	40 25345 09791 7	65	1400 x 900	450 / 450	1
4512258	40 25345 09792 4	75	1800 x 900	450 / 450	1

Special sizes available on request

JACKOBOARD® Aqua Reno

- Shower element with integrated drainage system and inspection chamber element
- Barrier-free system solution for existing buildings
- Minimum installation height only 65 mm
- Including special adhesive and 10 m sealing tape for sealing joints
- Incorporated fall
- Integrated floor drain
- Can be tiled immediately
- Drainage rate: 0.5 l/s
- Water trap height: 22 mm
- Including a high-quality designer grate in solid brushed stainless steel



Art. no.	EAN code	Thickness mm	Dimensions mm	Pack content
4512048	40 25345 09695 8	80	900 x 900	1
4512049	40 25345 09696 5	50	1200 x 1200	1
4512050	40 25345 09697 2	80	1200 x 1200	1
4512051	40 25345 09698 9	50	1800 x 900	1
4512052	40 25345 09699 6	80	1800 x 900	1

Special sizes available on request

JACKOBOARD® Aqua Base

- Element to bring up JACKOBOARD® Aqua to the required level
- Fast and economical to handle
- Perforation for different positions for the drain

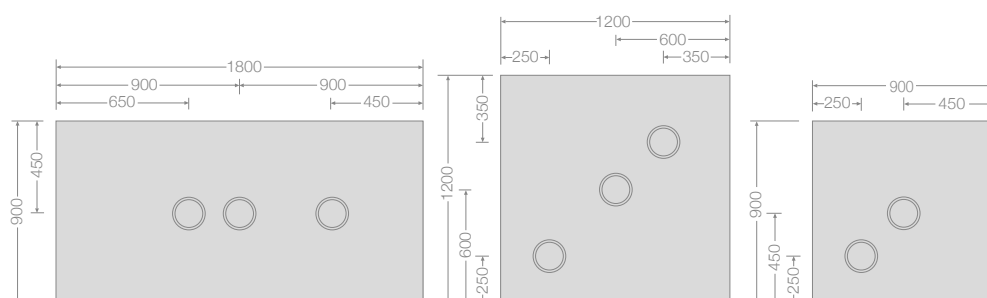

Shower elements

JACKOBOARD®
Aqua drain systems



Horizontal drain

- High-quality designer grate in solid brushed stainless steel
- Grate frame height adjustable from 3 to 18 mm
- Super-flat drain with a minimum installation height including shower element of only 97 mm
- High drainage rate 0.9 l/s
- Water trap height 50 mm
- DN 50
- Drain nozzle made of glueable ABS plastic
- For more information, see page 27



Art. no.	EAN code	Content
4512007	40 25345 09478 7	1

Vertical drain

- High-quality designer grate in solid brushed stainless steel
- Grate frame height adjustable from 3 to 18 mm
- High drainage rate 0.9 l/s
- Water trap height 50 mm
- DN 40/50
- Drain nozzle made of glueable ABS plastic
- For more information, see page 27



Art. no.	EAN code	Content
4512008	40 25345 09479 4	1

Also available in fire protection design on request!



Art. no.	EAN code	Thickness mm	Dimensions mm	Pack content
4512135	40 25345 09482 4	4	120 x 120	1

JACKOBOARD®
Terra
stainless steel grate

- in solid stainless steel
- brushed surface

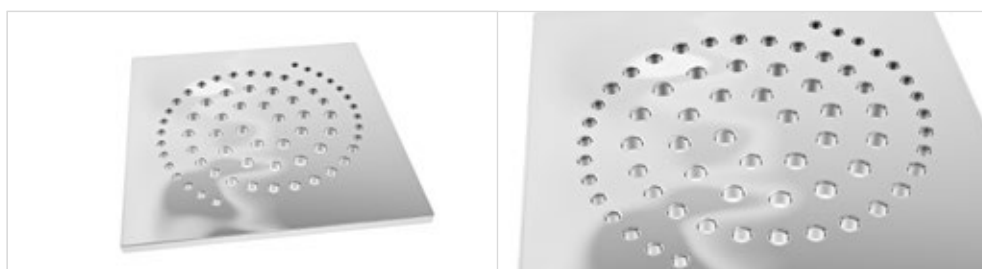

Art. no.	EAN code	Thickness mm	Dimensions mm	Pack content
4512137	40 25345 09484 8	4	120 x 120	1

JACKOBOARD®
Stella
stainless steel grate

- in solid stainless steel
- brushed surface



Art. no.	EAN code	Thickness mm	Dimensions mm	Pack content
4512136	40 25345 09483 1	4	120 x 120	1

JACKOBOARD®
Sol
stainless steel grate

- in solid stainless steel
- brushed surface



Art. no.	EAN code	Height mm	Dimensions mm	Pack content
4512138	40 25345 09485 5	90	130 x 130	1

JACKOBOARD®
Nova
tileable drain cover

- Tileable drain cover to replace steel grate
- Tileable tray in stainless steel
- Tray edged with stainless steel upstand
- Suitable for tiles with thicknesses from 8 mm

Shower elements

JACKOBOARD® Aqua Line pro

- Shower element with drainage channel in brushed stainless steel
- Frame height is adjustable from 6-21 mm to accommodate different tile thicknesses
- High drainage rate of up to 1.05 l/s
- Stainless steel linear grate can be inserted upside down and tiled on the back
- Bar and frame made of stainless steel
- Smooth, easy-clean surface with self-cleaning effect
- Low installation height
- Water trap height 50 mm

Order the drain separately (see below)



1-sided fall (see drawing)

Art. no.	EAN code	Thickness mm	Channel width mm	Length x Width mm	Content
4510330	40 25345 08514 3	60/43	750	1000 x 900	1
4510331	40 25345 08515 0	70/43	850	1100 x 1000	1
4510333	40 25345 08517 4	70/43	750	1400 x 900	1
4510336	40 25345 08520 4	80/43	750	1800 x 900	1
4510332	40 25345 08516 7	70/43	950	1200 x 1100	1
4510334	40 25345 08518 1	70/43	1150	1400 x 1300	1

4-sided fall (see drawing)

Art. no.	EAN code	Thickness mm	Channel width mm	Length x Width mm	Content
4510335	40 25345 08519 8	60	950	1600 x 1000	1

Special sizes available on request

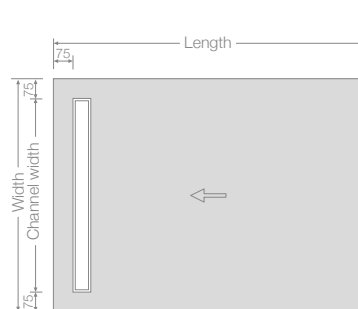

1-sided fall

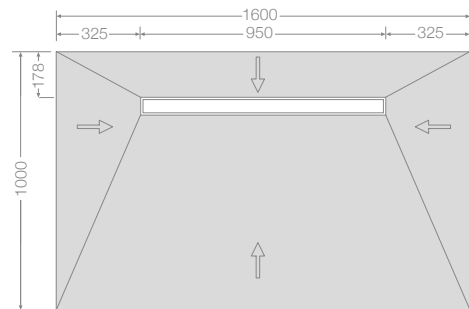

4-sided fall

JACKOBOARD® Aqua Line pro drain systems

Horizontal drain

- Fits JACKOBOARD® Aqua Line pro
- Height: 70 mm
- DN 50

Vertical drain

- Fits JACKOBOARD® Aqua Line pro
- Height: 192 mm
- Thickness: 156 mm
- DN 50



Art. no.	EAN code	Content
4510370	40 25345 08560 0	1

Art. no.	EAN code	Content
4510371	40 25345 08561 7	1

Shower elements



Art. no.	EAN code	Length mm	Upstand in mm	Version*	Pack content
4506484	40 25345 05856 7	1480	10	right	1
4506485	40 25345 05857 4	1480	10	left	1
4511939	40 25345 09474 9	2000	10	right	1
4511940	40 25345 09475 6	2000	10	left	1

*Model on the left on the product photo

JACKOBOARD® Aqua Line Profile

- Accessorie for JACKOBOARD® Aqua Line pro
- Side edge profile for insertion between JACKOBOARD® Aqua Line pro and the screed
- Edge with 2 % fall to match the JACKOBOARD® Aqua Line pro
- Track made of brushed stainless steel

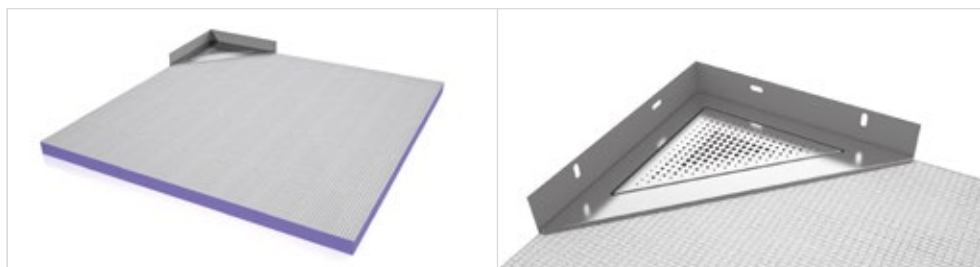

Art. no.	EAN code	Thickness mm	Dimensions mm	Pack content
4506488*	40 25345 05860 4	50	900 x 900	1
4506489*	40 25345 05861 1	50	1200 x 1200	1

*on request

JACKOBOARD® Aqua Delta

- Shower element with corner drain for barrier-free showers
- Height-adjustable grate made of brushed stainless steel
- Sealed stainless steel flange with edge that can be tiled over
- Incorporated fall
- Special sizes available on request
- Can be covered directly with tiles
- Incl. horizontal drain system

In addition to the standard sizes, JACKOBOARD® Aqua Line and JACKOBOARD® Aqua Delta shower elements are also available in a wide range of made-to-measure sizes and shapes on request.

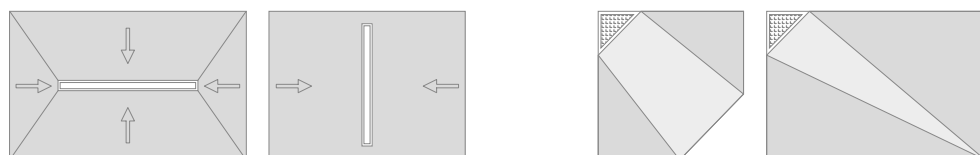

JACKOBOARD® Aqua Line pro

JACKOBOARD® Aqua Delta

Shower elements

JACKOBOARD® Aqua Spiral



Shower partition

- Curved Shower in the shape of an Archimedes spiral
- Outer dimensions 2055 x 1696 mm
- Height 2150 mm
- Thickness 50 mm
- Consisting of separate partition walls with groove and feather connections
- Inside wall surface approx. 10.7m²
- Outside wall surface approx. 11.4m²

Art. no.	EAN code	Thickness mm	Height mm	Version	Content
4511717*	40 25345 09444 2	50	2150	entrance left	1
4511719*	40 25345 09446 6	50	2150	entrance right	1

*on request

Floor element

- Barrier-free shower element with incorporated gradient
- Groove for insertion of partition elements
- Thickness 50 mm
- Inside floor surface approx. 2.1 m²
- Curved shower available in other sizes on request
- Drain system included
- Can be covered directly with tiles

Art. no.	EAN code	Thickness mm	Dimensions mm	Version	Content
4512106*	40 25345 09746 7	50	2055 x 1696	entrance right	1
4512105*	40 25345 09743 6	50	2055 x 1696	entrance left	1

*on request

Order the drain separately (p. 14)

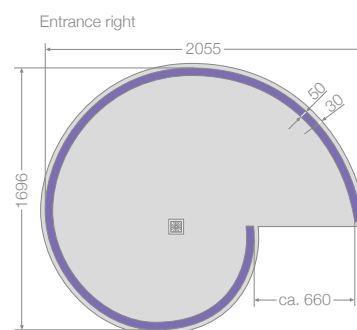
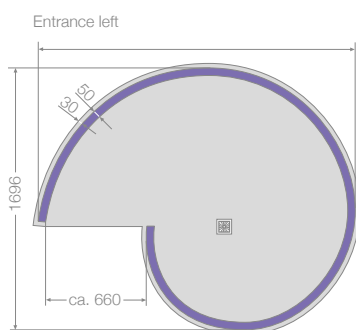

Shower elements



Art. no.	EAN code	Thickness mm	Height mm	Content
4503176*	40 25345 03176 8	50	2150	1

*on request

Art. no.	EAN code	Thickness mm	Dimensions mm	Content
4512104*	40 25345 09742 9	40	1200 x 1200	1

*on request

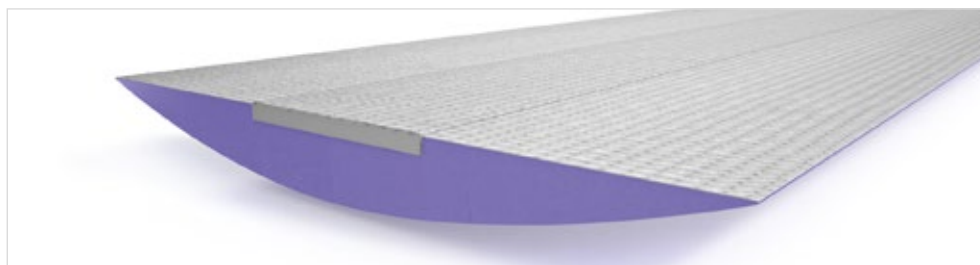

Art. no.	EAN code	Thickness mm	Length mm	Width mm	Content
4505094*	40 25345 05094 3	32	2200	345	1

*on request

JACKOBOARD® Aqua Circle

Shower partition wall

- Shower partition wall consisting of 5 elements with tongue and groove connection
- Inside wall surface approx 5.82 m²
- Outside wall surface approx. 6.39 m²
- Special dimensions possible on request
- Can be tiled immediately

Floor element

- Barrier-free shower element with incorporated fall
- Internal diameter 1000 mm
- External diameter 1100 mm
- Groove for insertion of partition elements
- Inside floor surface approx. 0.8 m²

Order the drain separately (p. 14)

JACKOBOARD® Panel

- Panel for mounting taps, shower heads and piping to complete JACKOBOARD® Aqua Circle
- With incorporated reinforcement plate and cut-out section at the back for pipes
- Curve radius r = 500 mm
- Special sizes available on request
- Can be covered directly with tiles

Accessories

JACKOBOARD® Sealing set

- For completely tight joint seals in shower areas
- Sealing set consisting of 1x powder component, 1x liquid component, 10 m sealing tape, 2 x sealing corners



Art. no.	EAN code	Pack content
4504509	40 25345 04509 3	1

BOARD-FIX® adhesive and sealing agent

- Special adhesive and sealing agent
- For gluing JACKODUR® and JACKOBOARD®
- For sealing JACKOBOARD® construction board joints in wet areas
- One cartridge is sufficient for about 9 running metres



Art. no.	EAN code	Volume ml	Pcs./box
4506342	40 25345 05865 9	290	12

JACKOBOARD® Assembly adhesive

- Cartridges made from PE, solvent-free PU-based adhesive
- For gluing JACKODUR® and JACKOBOARD®
- Very fast curing
- Cartridge gun available on request
- One cartridge is sufficient for about 10 running metres



Art. no.	EAN code	Volume ml	Pcs./box
4510610	40 25345 08725 3	310	12

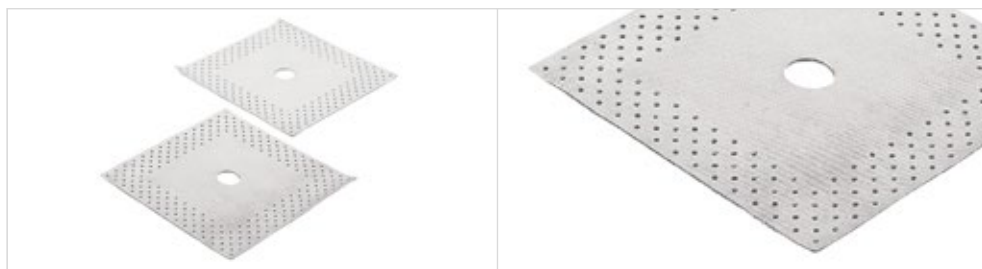

Art. no.	EAN code	Pcs./unit
4501725	40 25345 01725 0	2

JACKOBOARD® Collars

- For sealing passage holes for pipes through JACKOBOARD® construction elements in wet rooms

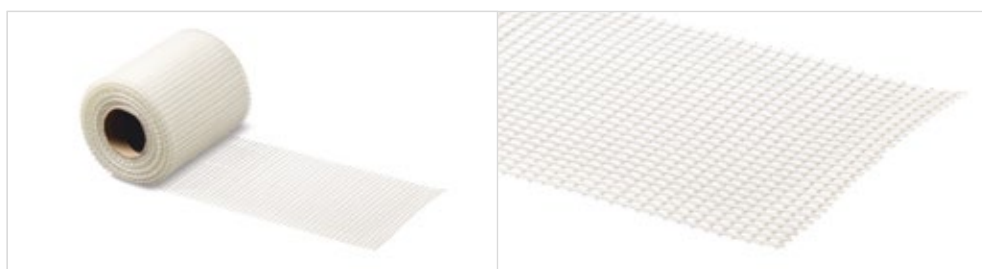

Art. no.	EAN code	Width mm	Roll length m	Pack content pcs.
4513178	40 25345 10279 6	12,5	25	4

JACKOBOARD® Glass fibre tape

- For reinforcing the abutting edges of JACKOBOARD® elements
- Self-adhesive



Art. no.	EAN code	Width cm	Roll length m	Pack content pcs.
4500058	40 25345 00058 0	12,0	50	1
4501715	40 25345 01715 1	12,0	10	1

JACKOBOARD® Sealing tape

- For sealing the abutting edges of JACKOBOARD® elements in wet areas
- With a central rubber coating



Art. no.	EAN code	Pcs./box
4500151	40 25345 00151 8	50
4506091	40 25345 05852 9	2

JACKOBOARD® 4 E corners

- Prefabricated corners for sealing JACKOBOARD® elements in wet areas

Accessories

JACKOBOARD® Glass fibre tape

- For reinforcing the abutting edges of JACKOBOARD® Plano Premium elements

NEW

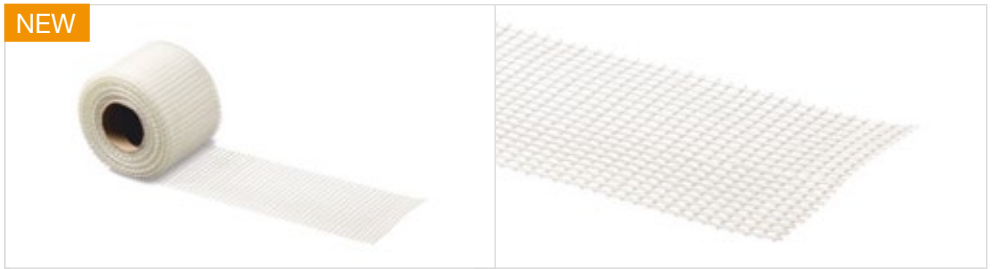

Art. no.	EAN-Code	Width cm	Roll length m	Pack content pcs.
4513293	40 25345 09489 3	7	25	10

JACKOBOARD® Construction board disc

- Insulation board disk in plastic
- dia. 60 mm
- Internal dia. 5 mm



Art. no.	EAN code	Dimensions mm	Pcs./box
4500229	40 25345 00229 4	ø 60	100

JACKOBOARD® Construction board disc

- Galvanized insulation board disk
- dia. 50 mm and dia. 76 mm
- Internal dia. 5 mm



Art. no.	EAN code	Dimensions mm	Pcs./box
4500230	40 25345 00230 0	ø 50	100

JACKOBOARD® Construction board disc

- Stainless steel insulation board disk
- dia. 36 mm
- Internal dia. 5,5 mm
- 5 pcs/m²

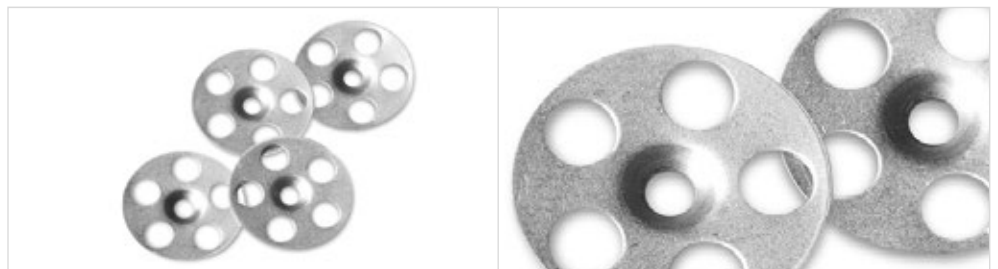

Art. no.	EAN code	Dimensions mm	Pcs./box
4501171	40 25345 01171 5	ø 36	100



Art. no.	EAN code	inside measurement mm	Anchor for angle element pcs./box
4500036	40 25345 00036 8	2,0	100
4500015	40 25345 00015 3	3,0	100

JACKOBOARD® Anchor

- For fastening JACKOBOARD® Canto and JACKOBOARD® Plano

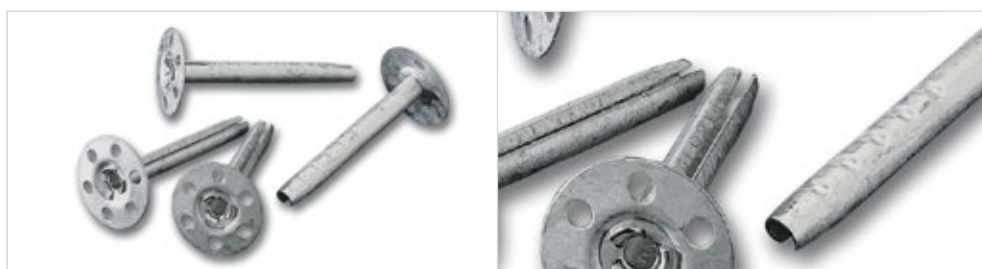

Art. no.	EAN code	Dimensions mm	Pack content pcs.
4506483	40 25345 05855 0	50	250
4500164	40 25345 00164 8	80	250
4500530	40 25345 00530 1	110	250
4500165	40 25345 00165 5	140	250

JACKOBOARD® Metal disk plugs

- for mounting JACKOBOARD® Plano
- 5 pcs/m²
- Dowel hole \varnothing 8 mm

The JACKOBOARD® construction board system - versatile and fully compatible.



A

JACKOBOARD® Plano

The high-quality "all-rounder". Walls, floors, bath panelling or furniture constructions. Anything is possible with the construction board JACKOBOARD® Plano.

C

B

JACKOBOARD® Flexo/Flexo Plus

Pliable and flexible. With these bendable construction boards, round shapes can be created very easily.

D

Our complete JACKOBOARD® range is available on:
www.jackon-insulation.com/jackoboard



JACKOBOARD® Aqua

Floor-level shower elements for barrier-free showers.
Available in many different designs.

JACKOBOARD® Wabo

The fast and easy way to panel bathtubs.

E

JACKOBOARD® Canto

Pre-fabricated element for fast pipe cladding.

F

JACKOBOARD® Sabo

Assembly kit for cladding WC wall elements.

Technical specifications

JACKOBOARD® Plano construction board
 JACKOBOARD® Plano Premium

Properties	Standard	Unit	XPS core
Bulk density	EN 1602	kg/m ³	> 30
Thermal conductivity λ_D	EN 13164	W/(m·K)	0,034 ¹⁾
Compressive strength and/or compressive stress at 10% compression	EN 826	N/mm ²	> 0,30 ²⁾
Dimensional stability at 70°C and 90% relative humidity	EN 1604	%	≤ 5
Deformation under 40 kPa load and 70°C temperature	EN 1605	%	≤ 5
Vapour diffusion resistance factor μ (dependent on the thickness)	EN 12086	-	200 - 60
Water absorption on long-term immersion	EN 12087	Vol-%	≤ 1
Linear thermal expansion coefficient	-	mm/(m·K)	0,07
Fire behaviour	EN 13501-1	Class	Euroclass E
Working temperature	-	°C	-50 /+75

¹⁾ 80 mm $\lambda_D = 0,035$ W/(m·K)

²⁾ 0,2 N/mm² for Plano construction board 20 mm and Plano Premium ≤ 20 mm

Properties	Standard	Unit	JACKOBOARD® Plano
Tensile strength	EN 1607	kPa	> 200
Tolerances	Width	EN 822	mm
	Length	EN 822	mm
	Rectangularity	EN 824	mm/m
	Evenness	EN 825	mm
Edge profile	-	-	butt edge

We would like to point out that the data, images, technical information and drawings provided in the brochure are general details and only constitute suggestions. The illustrations are schematic and demonstrate the basic functional principle. Exact dimensions are not specified. The fabricator/customer is responsible for testing the applicability with regard to the respective construction project. All specifications and data must be adapted to local conditions and do not constitute construction, detail or installation documentation. The technical specifications and data for the products in the data sheets and system descriptions/approvals must be observed.

JACKOBOARD® Aqua shower element

Properties	Unit	Value
Compressive strength at 10% compression according to EN 826 (XPS core)	kPa	> 300
Tensile strength	kPa	> 200
Fall	-	integrated
Thickness	mm	20, 40, 50
Minimum tile size	mm	25 x 25 x 4 ¹⁾
Wheelchair accessible from tile size	mm	50 x 50 x 6,5
Fire behaviour	-	Euroclass E
Thermal conductivity (λ_p) according to EN 13164 (XPS core)	W/(m·K)	0,035

¹⁾ For smaller tile sizes the joints must be grouted with epoxy resin grout.

Horizontal drain (Art. no. 4512007)

Properties	Unit	Value
Drainage rate	l/s	0,9
Installation height	mm	77
Water trap height	mm	50 ²⁾
Grate load class	-	K3
Pipe connection	-	DN 50
Grate size	mm	120 x 120 x 4
Grate frame size	mm	130 x 130 x 9
Tile thickness incl. plaster	mm	3-38

²⁾ Installation height incl. shower element up to 97 mm

Vertical drain (Art. no. 4512008)

Properties	Unit	Value
Drainage rate	l/s	0,9
Installation height	mm	115 ³⁾
Water trap height	mm	50
Grate load class	-	K3
Pipe connection	-	DN 40 and DN 50
Grate size	mm	120 x 120 x 4
Grate frame size	mm	130 x 130 x 9
Tile thickness incl. plaster	mm	3-38

³⁾ Floor drain underside (without drain nozzle)

Imprint

Concept, creation, editing and product visuals *KAGADO! Werbeagentur*
 Photography *getty images, fotolia, istock* | Printing *Druckhaus Fromm*
 JACKON Insulation GmbH | Carl-Benz-Straße 8 | D-33803 Steinhagen
 T +49 (0) 5204 9955-0 | F +49 (0) 5204 9955-400 | info@jackodur.com | jackon-insulation.com

Solutions for construction. Simple but effective.



JACKON Insulation GmbH
 Carl-Benz-Straße 8
 D-33803 Steinhagen

Tel: +49 (0) 5204 99 55-444

Fax: +49 (0) 5204 99 55-300

E-Mail: info@jackodur.com

www.jackon-insulation.com

Your dealer:

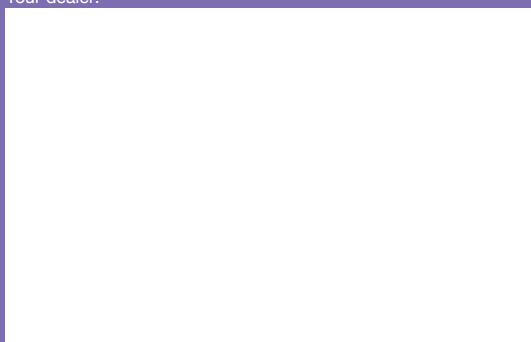

Reg.-Nr.067674

