

10*12FT Hardtop Gazebo

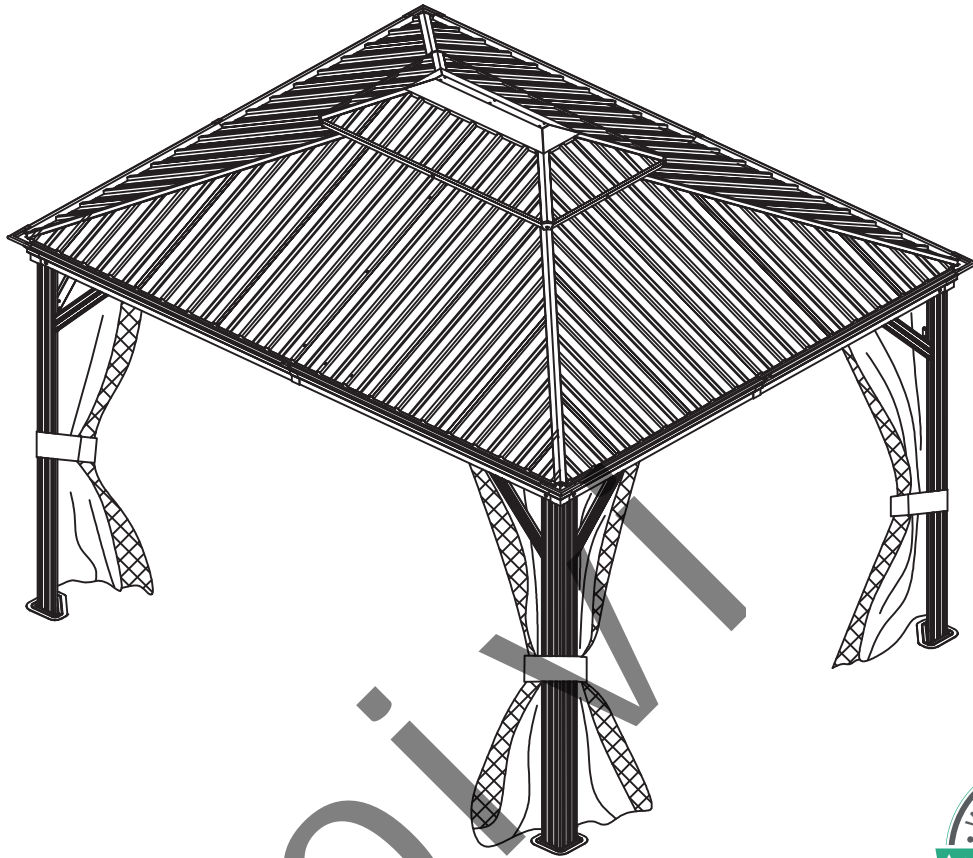

Thank you for choosing us!

Our goal is to provide high quality outdoor furniture with outstanding customer service-all at an affordable price.

Please let us know how we are doing!

Problems?

(Missing pieces, wrong pieces...)

We will fix it immediately. Send us an email at aftersaledirect@gmail.com.

Happy?

Please leave us a review!
You can make others happy too!

Please prepare below tools before installation.

Package not included

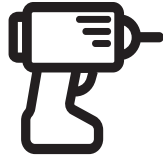

Electric Screwdriver



+ Manual Screwdriver



Ladder

Package included Tools



Gloves X 1 Pair



Spanner X 1

ATTENTION:

Please read this instruction carefully before installation and follow it strictly during installation. Ensure that there are no problems later due to installation errors.

Installation Notes

Keep all children and pets away from assembly area.

Do not assemble the product in days of wind or rain.

You must schedule enough time to complete the assembly.

Please check the quantity of all parts before installation (Please refer to the Parts Lists) and the appearance of the products. Please make sure the product is correct before installation. If there is any problem, please contact us directly.

Make sure the anti-UV panels are facing outwards and all the holes match. The panels are textured, please install the panels in the order specified in the instructions. All lines and holes must be accurately matched to make the storage shed more stable. Please ensure that all screws are tightened to prevent the product from falling apart.

There is a protective film on the surface to protect the product, please tear it off after installation to get the final presentation. If you do not damage the film during installation, it can also remain on the product to protect the product.



Safety Precautions

We recommend at least two adults to complete the installation. Two adults installed together will make the installation process easier and safer.

The gloves must be carried to prevent hand cuts during installation.

Take care when using power tools near water the use of a residual current device (RCD) is advised. Please use the electric driver carefully during screwing to prevent the screw from slipping and hurting your hand. (We recommend that beginners use a manual screwdriver for installation.) Be careful not to fall when installing the roof. Please steady the ladder and make sure the product placed on a flat ground.

Check all screws for tightness before and during usage of the unit. Tighten the screws at least twice a year.

Care and Cleaning

For cleaning: use a domestic soap or a soft detergent and wash with warm water using a sponge or fabric cloth. Rinse with clean water.

Snow must always be removed from the roof of the unit.

The fabric roof, mosquito nets & curtains must be removed and stored during winter.

Do not hang any items to the structure.











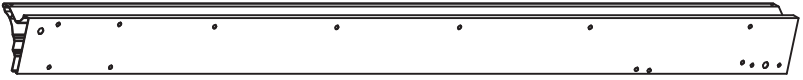

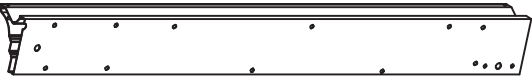
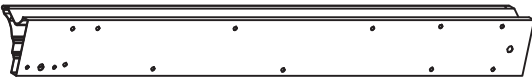
Disposing of the packaging

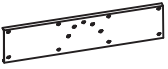







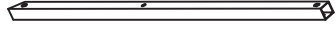



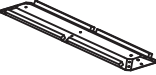

The packaging consists of cardboard and correspondingly marked plastics that can be recycled.

















– Make these materials available for recycling.











PLEASE KEEP THIS INSTRUCTION FOR FUTURE REFERENCE.





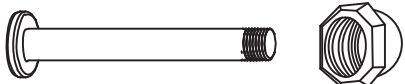
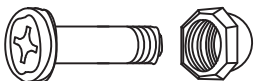
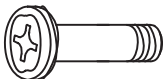
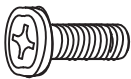

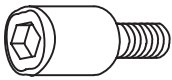
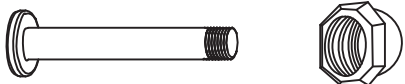

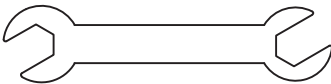
COMPONENT LIST

REFERENCE IMAGE	NO.	QTY
	A	4
	B	2
	B1	2
	B2	4
	C	2
	C1	2
	C2	4
	D	4
	E	4
	E1	4
	F1	2
	F2	2
	F3	2
	F4	2
	H	4
	I	4

REFERENCE IMAGE	NO.	QTY
	J	2
	J1	2
	K	1
	K1	1
	L1	4
	L2	4
	M1	4
	M2	8
	M3	4
	M4	4
	R1	2
	R2	2
	W	4
	W1	4
	W3	8
	W4	8

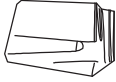
REFERENCE IMAGE	NO.	QTY
	N	2
	N1	2
	N2	2
	N3	2
	N4	2
	N5	2
	N6	2
	N7	2
	O	2
	O1	2
	O2	2
	O3	2
	O4	2
	O5	2
	P	2
	P1	2

REFERENCE IMAGE	NO.	QTY
	P2	2
	P3	2
	P4	2
	P5	2
	R	56
	D1	16
 M6x47	S	12
 M6x24	T	64
 M6x24	U	4
 M6x15	V	229
 M5x15	V1	40
 M6x12(D10X20)	X	16
 M6x42	X1	8
 ST3.8x12	Y	24
 ST4.2x13	Y1	16
	W2	1

REFERENCE IMAGE	NO.	QTY
	Z	1
	Z1	8
	Wa	2
	NN	4
	CC	4
	Q	104
	ZS1	2
	ZS2	2
	GG	1

ASSEMBLY STEPS

- 1 Insert the Post Base (M1) into Post (A) with Bolt (V).
Attach the Fasteners (W3/W4) to Post (A) with Bolt (V1).

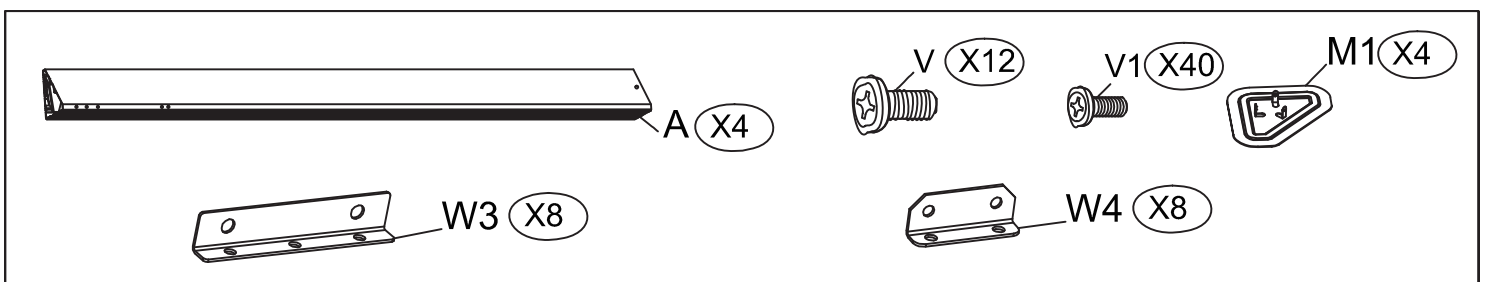
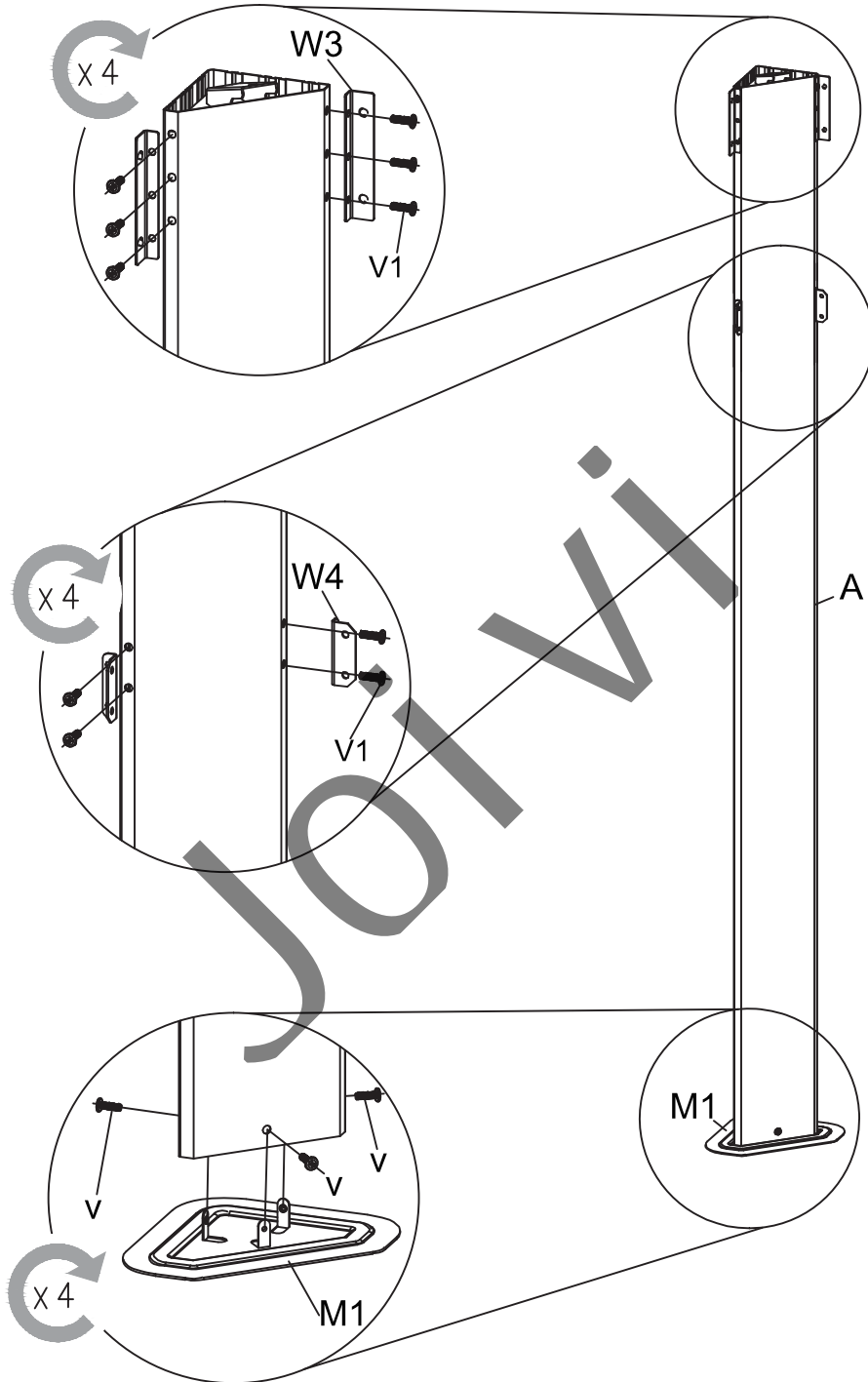

ASSEMBLY STEPS

- 2** Insert the beam lining (D) to the long beam (B & B1) and short beam (C & C1) with Bolt (V) .

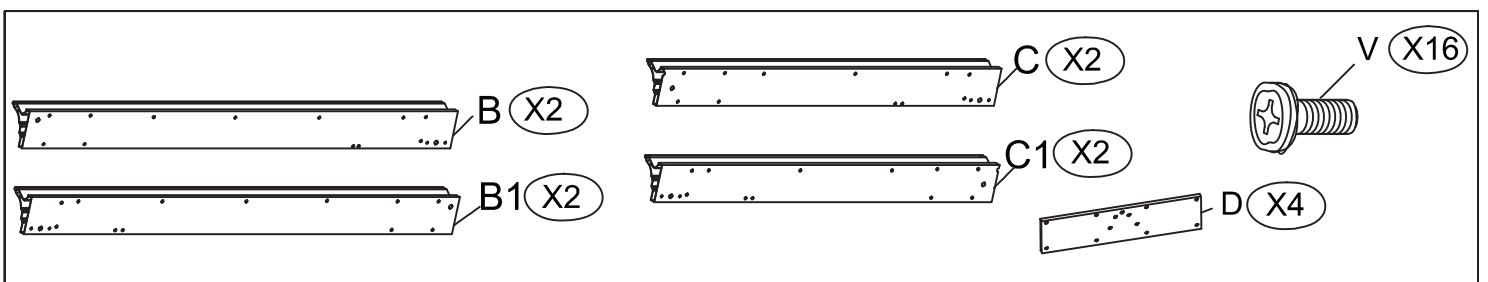
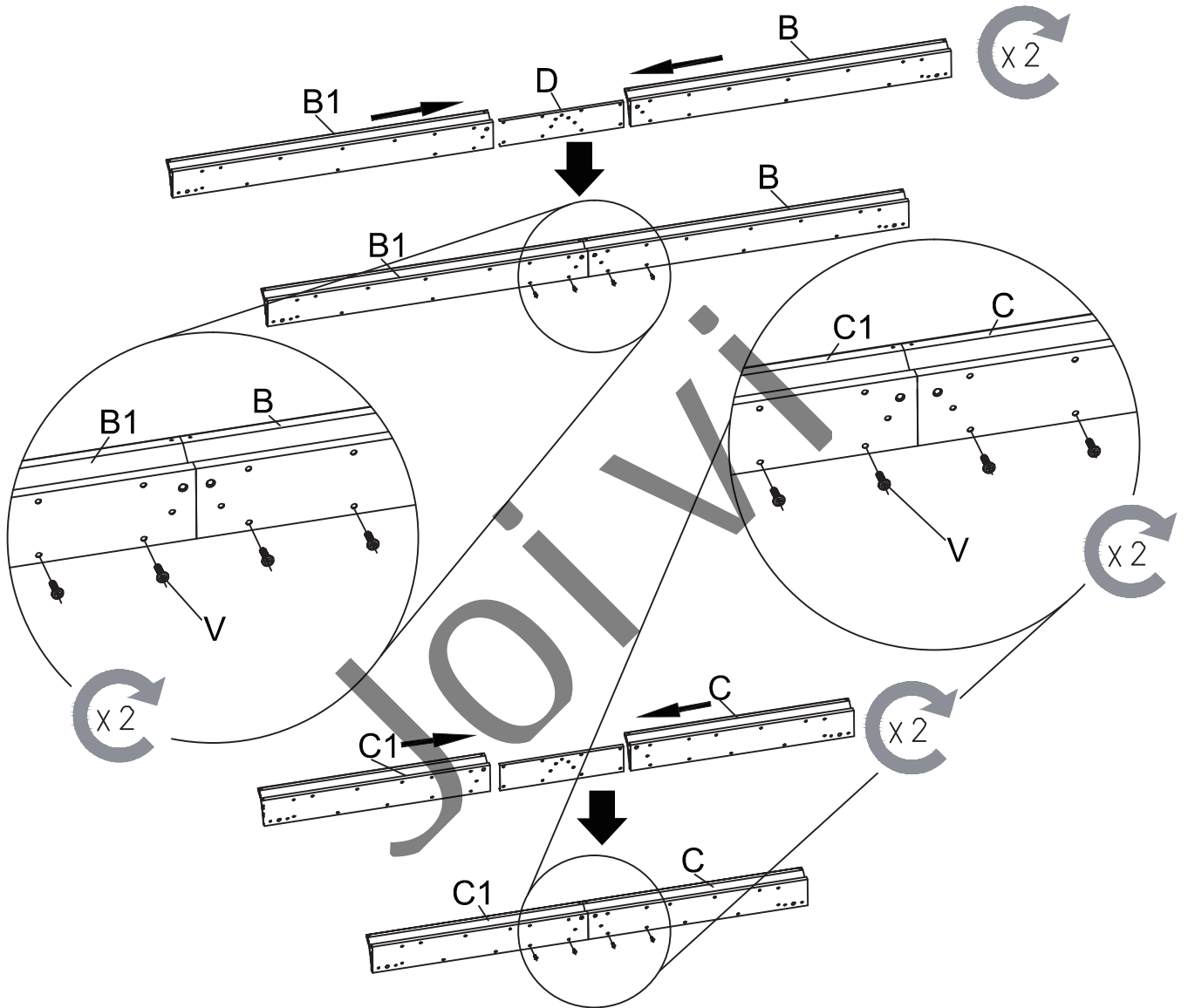

ASSEMBLY STEPS

- 3** Attach the Fastener (W3) to the long beam (B & B1) and short beam (C & C1) with Bolt (V).

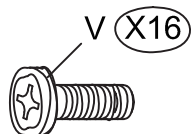
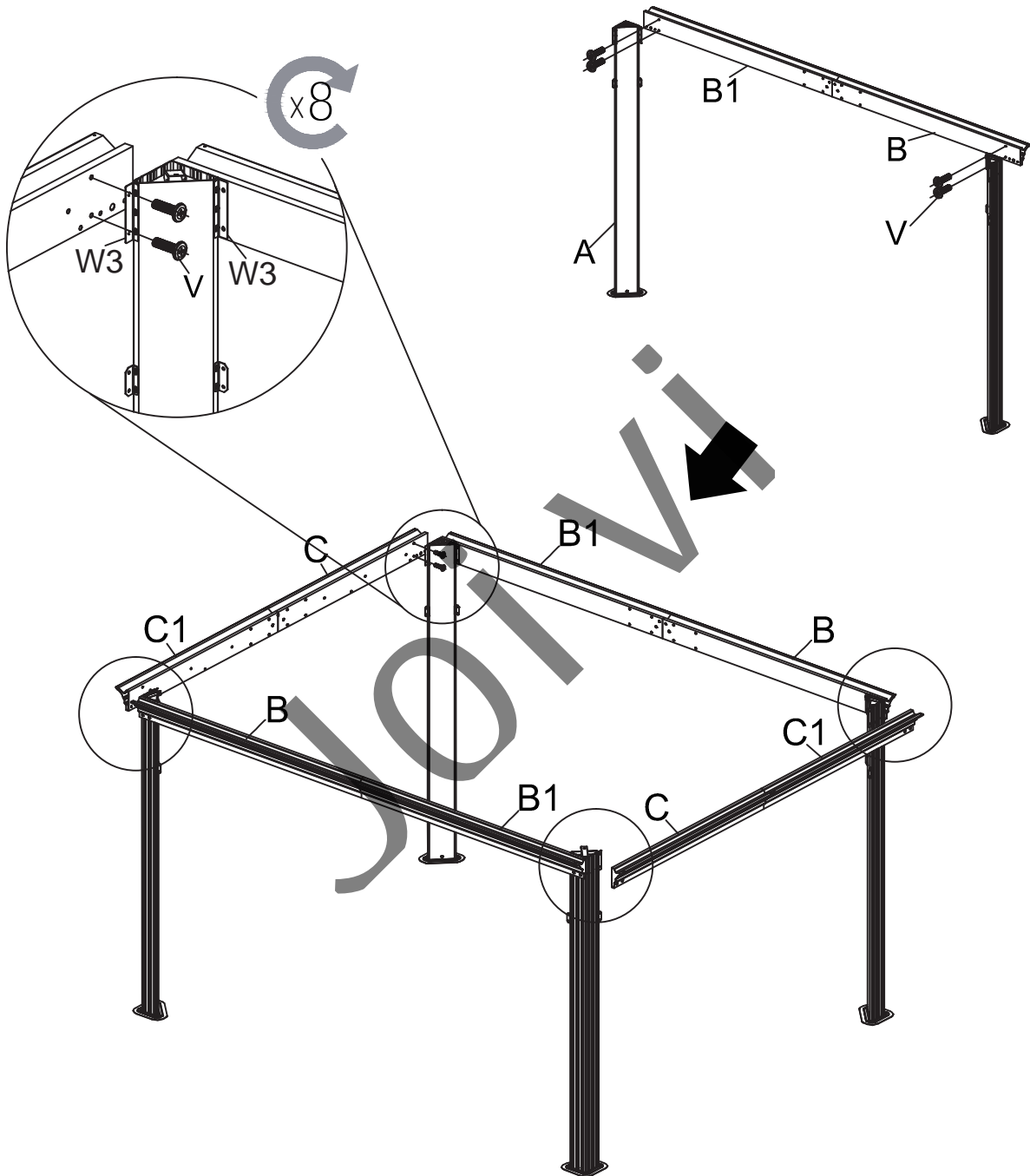

ASSEMBLY STEPS

- 4** Attach the assembled long beam (B & B1) and short beam (C & C1) to the 4 Post (A) with Bolt (X).

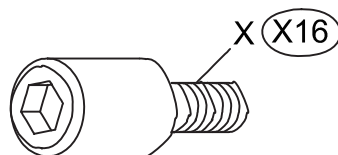
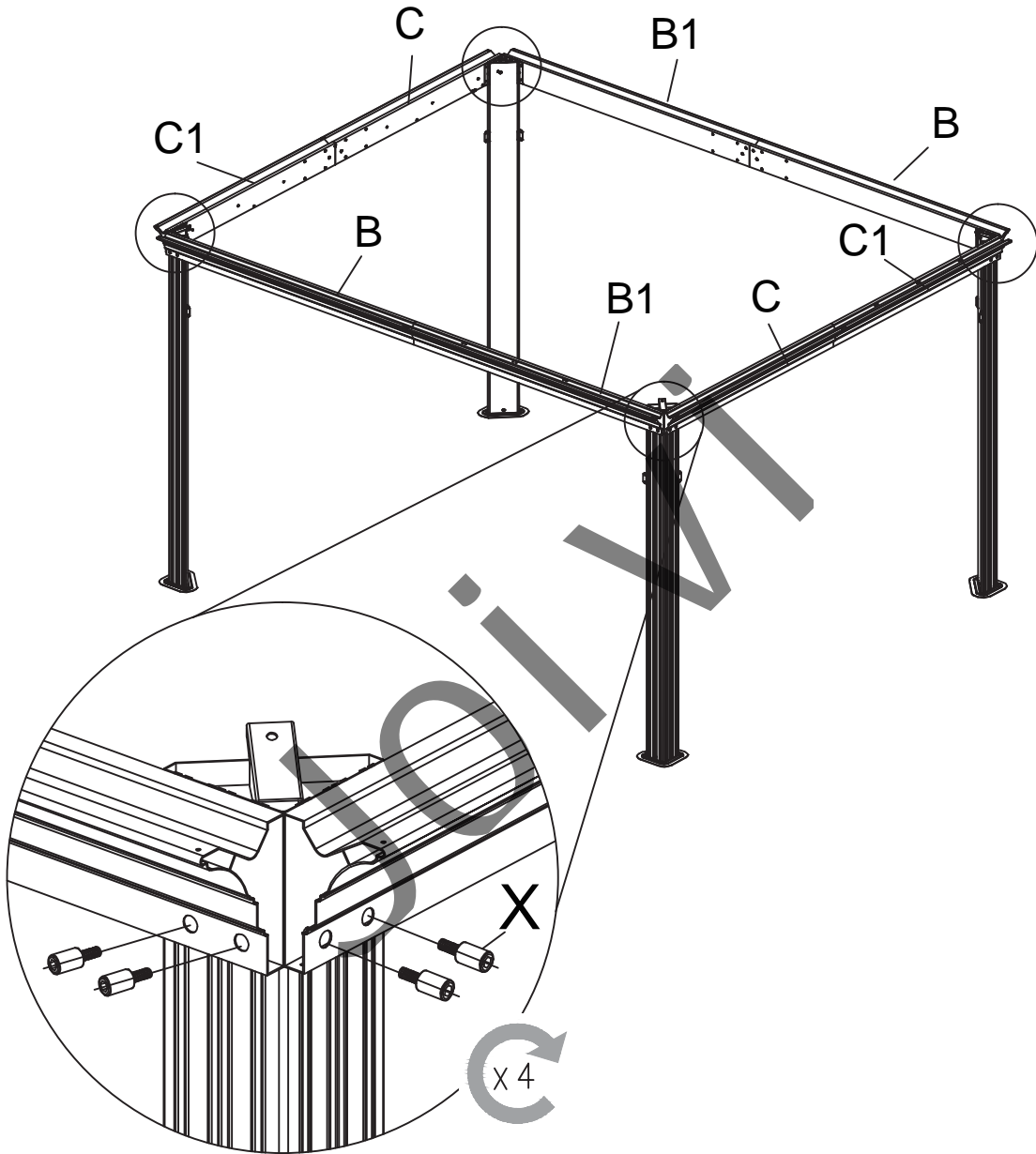

ASSEMBLY STEPS

- 5** Attach the sliding rod (B2 & C2) to the assembled long beam (B & B1) and short beam (C & C1) with Bolt (V).

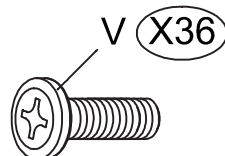
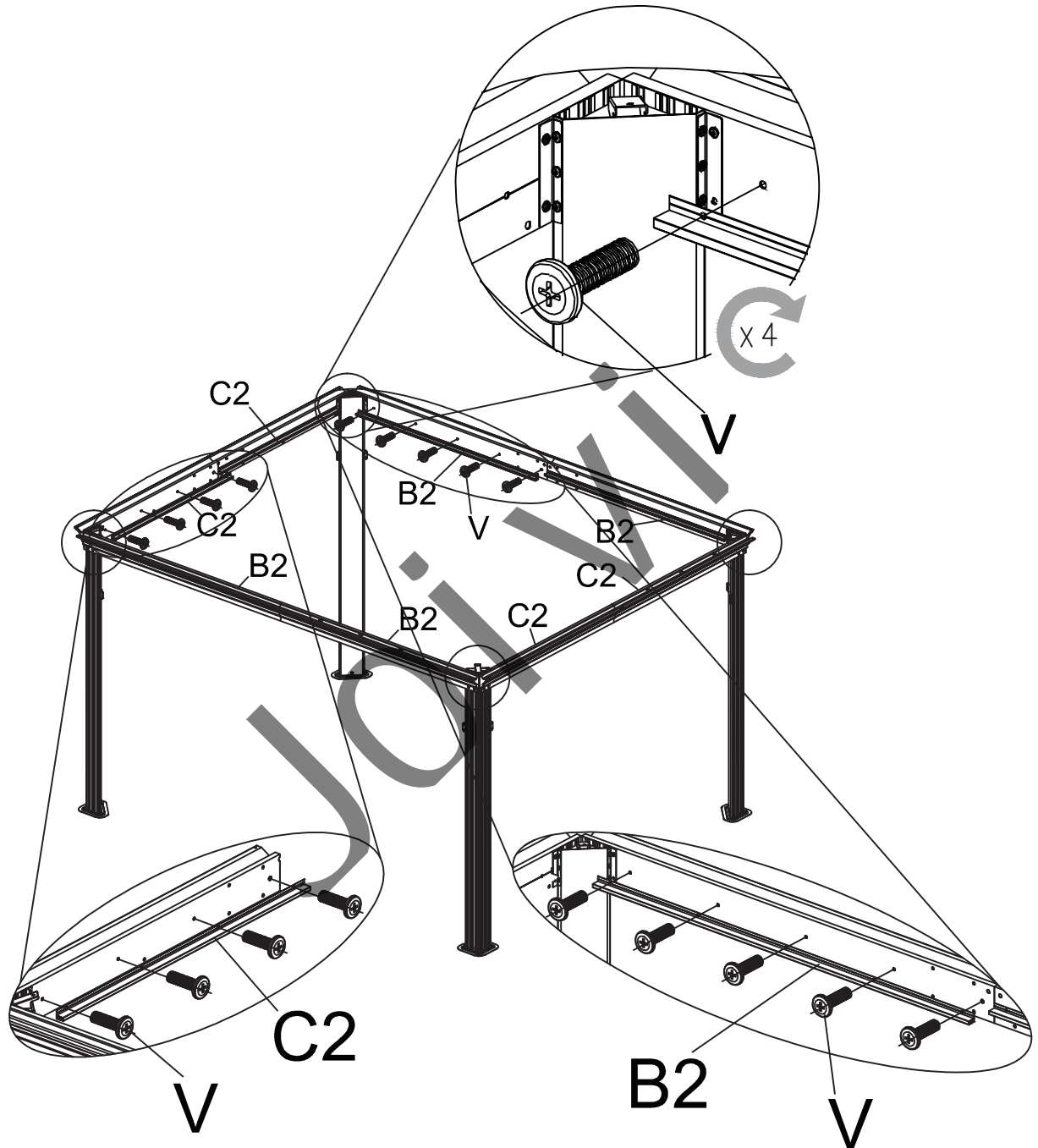

ASSEMBLY STEPS

- 6** Attach the Plug (Z1) & Hook (Q) to the sliding rod (B2 & C2).

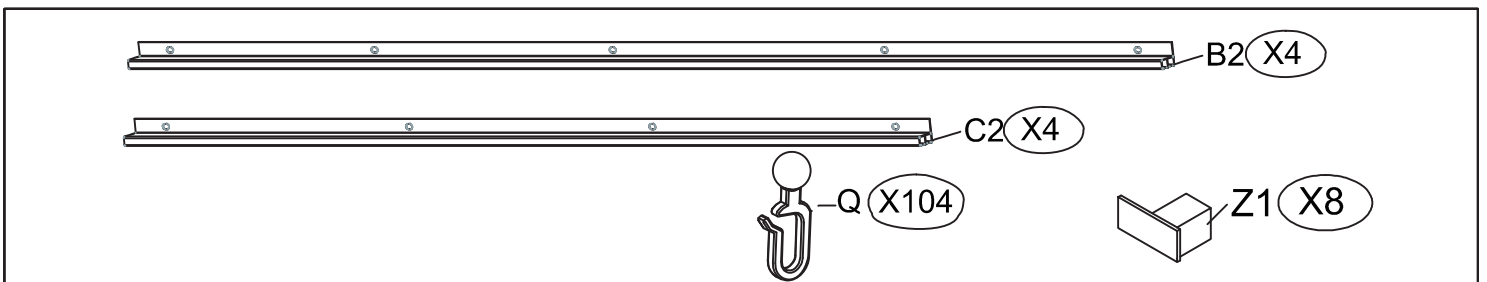
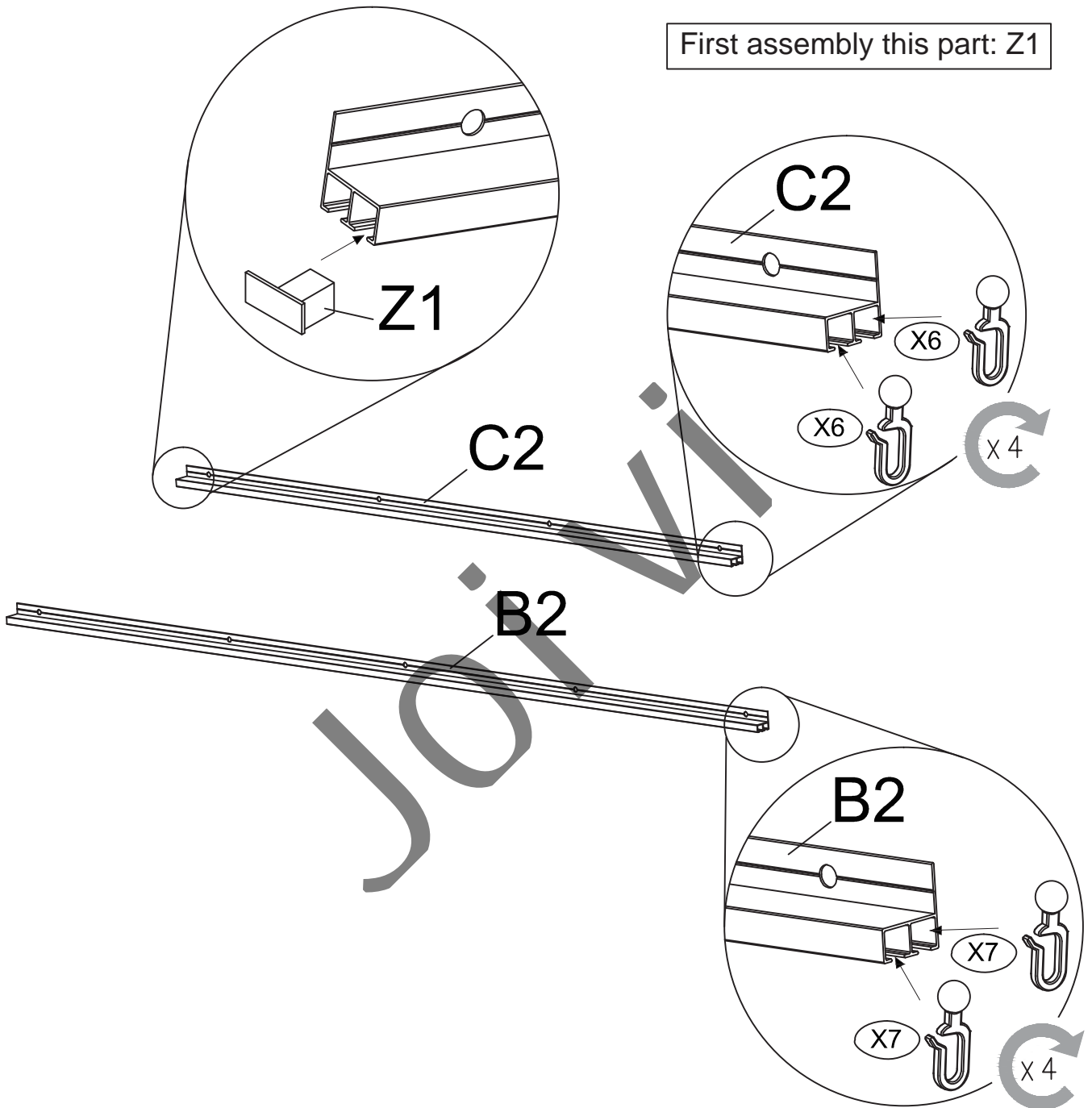

ASSEMBLY STEPS

- 7** Attach the corner connector (W) to the assembled long beam (B & B1) and short beam (C & C1) with Bolt (Y).
Attach the middle connector (W1) to the assembled long beam (B & B1) and short beam (C & C1) with Bolt (V).

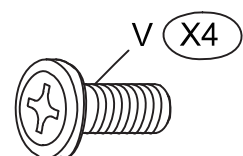
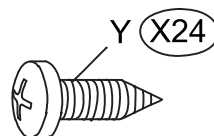
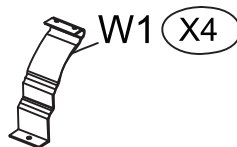
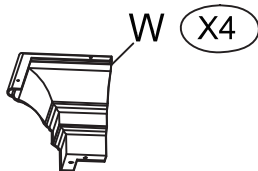
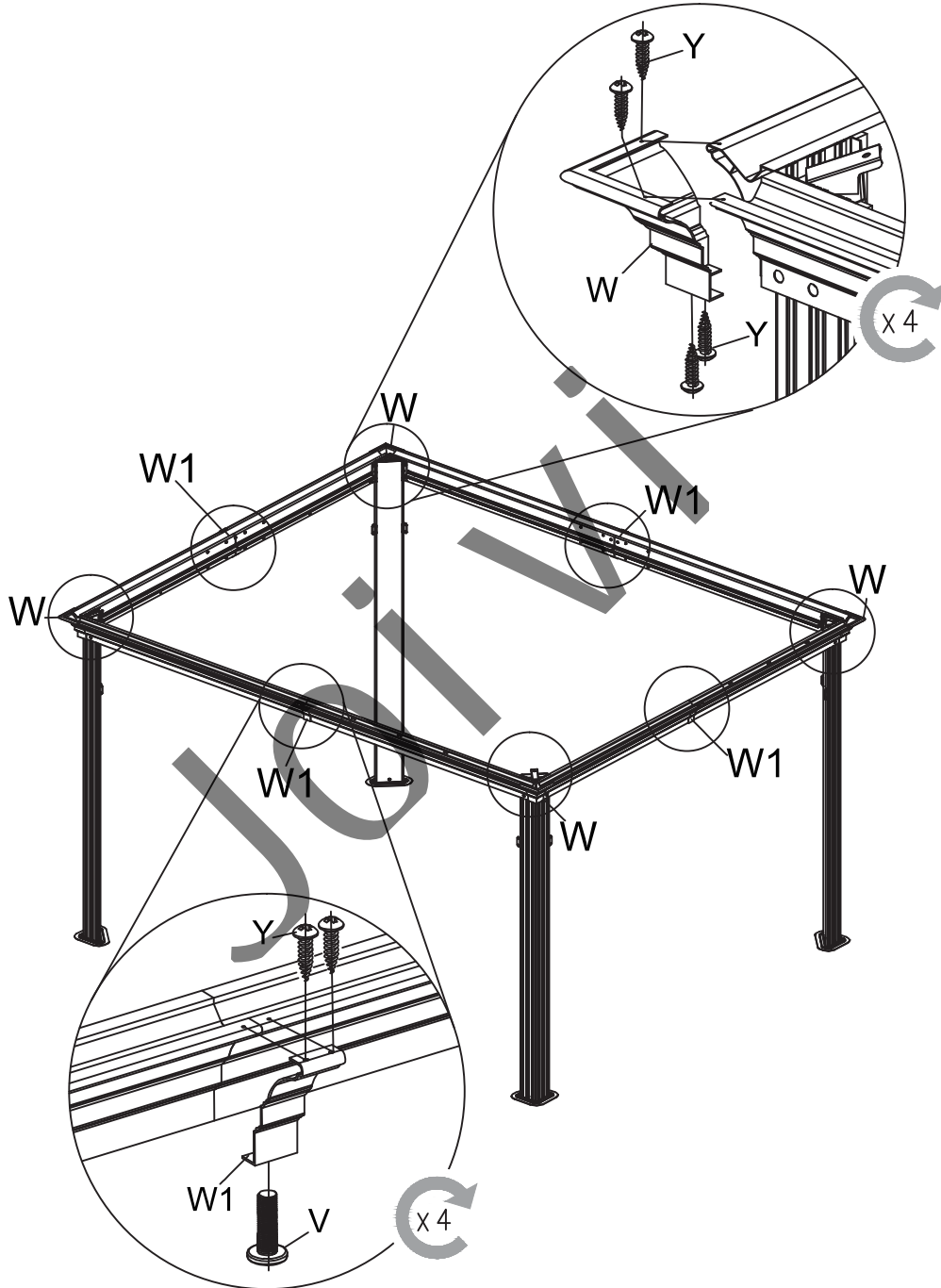

ASSEMBLY STEPS

- 8 Attach Support Bar (L1 & L2) to the assembled long beam (B & B1) and short beam (C & C1) with Bolt (V).

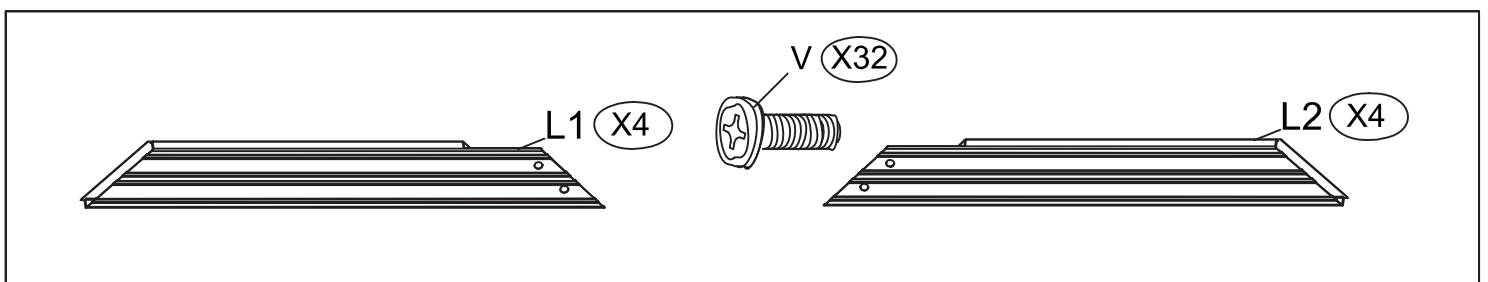
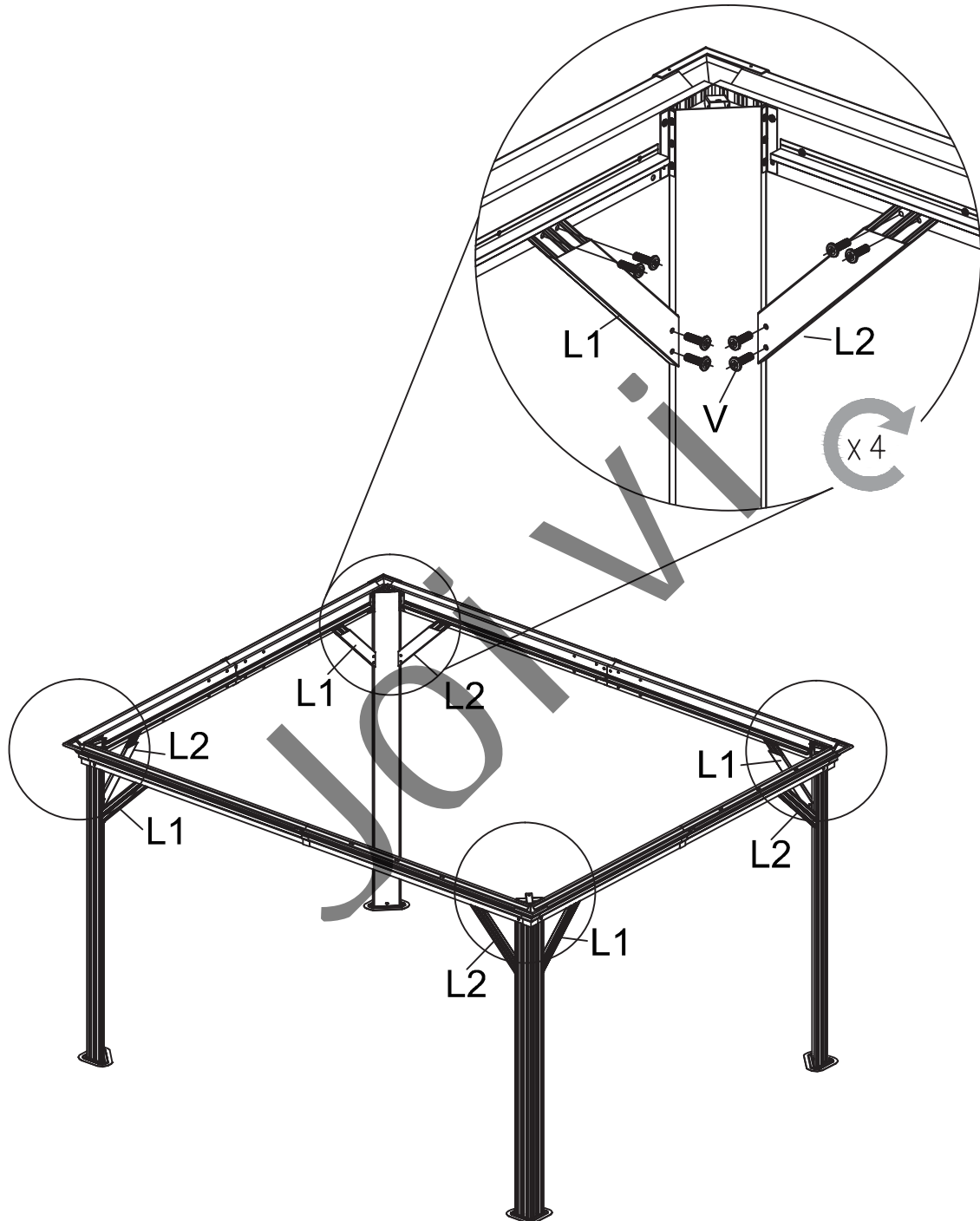

ASSEMBLY STEPS

- 9** Attach Fixed Rod (F1 & F2 & F3 & F4) to the assembled long beam (B & B1) and short beam (C & C1) with Bolt (V).

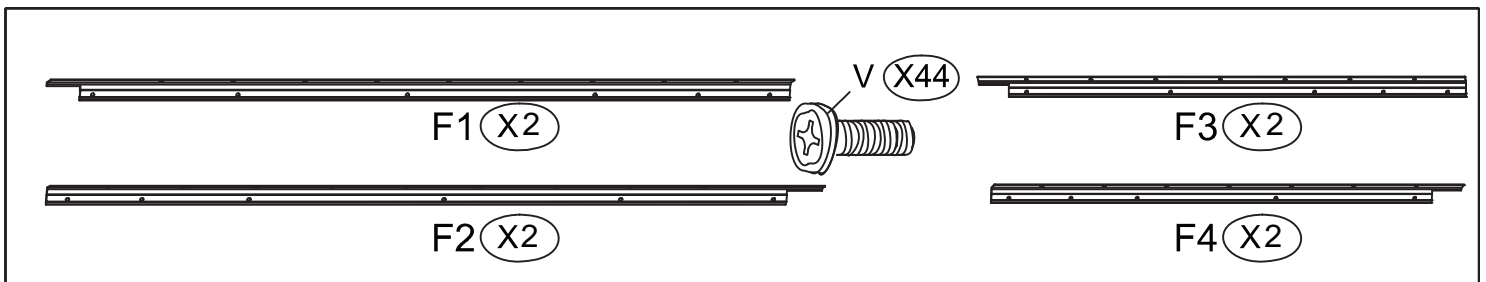
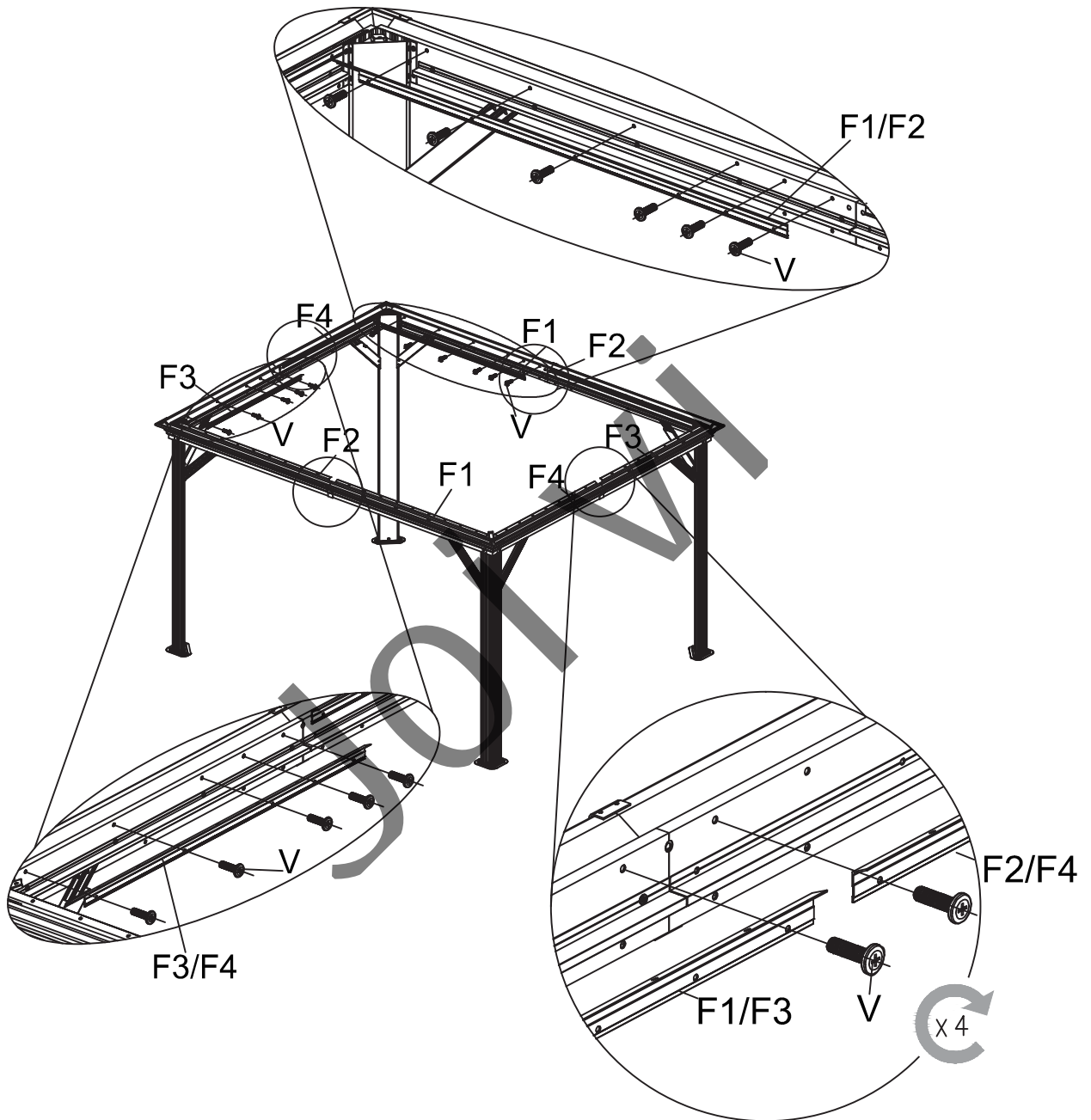

ASSEMBLY STEPS

- 10** Attach the connector rod (E) to the small roof base(K1) with bolt(V).

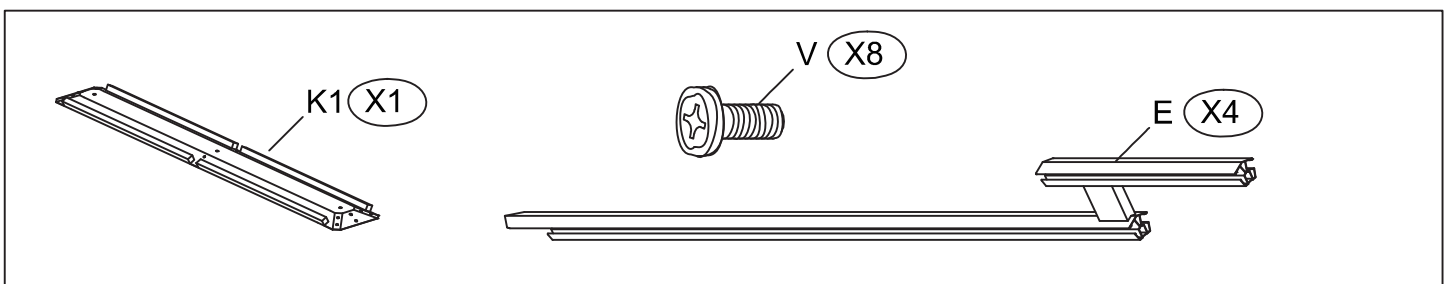
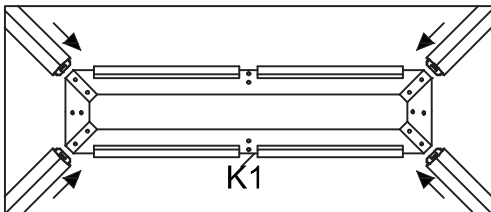
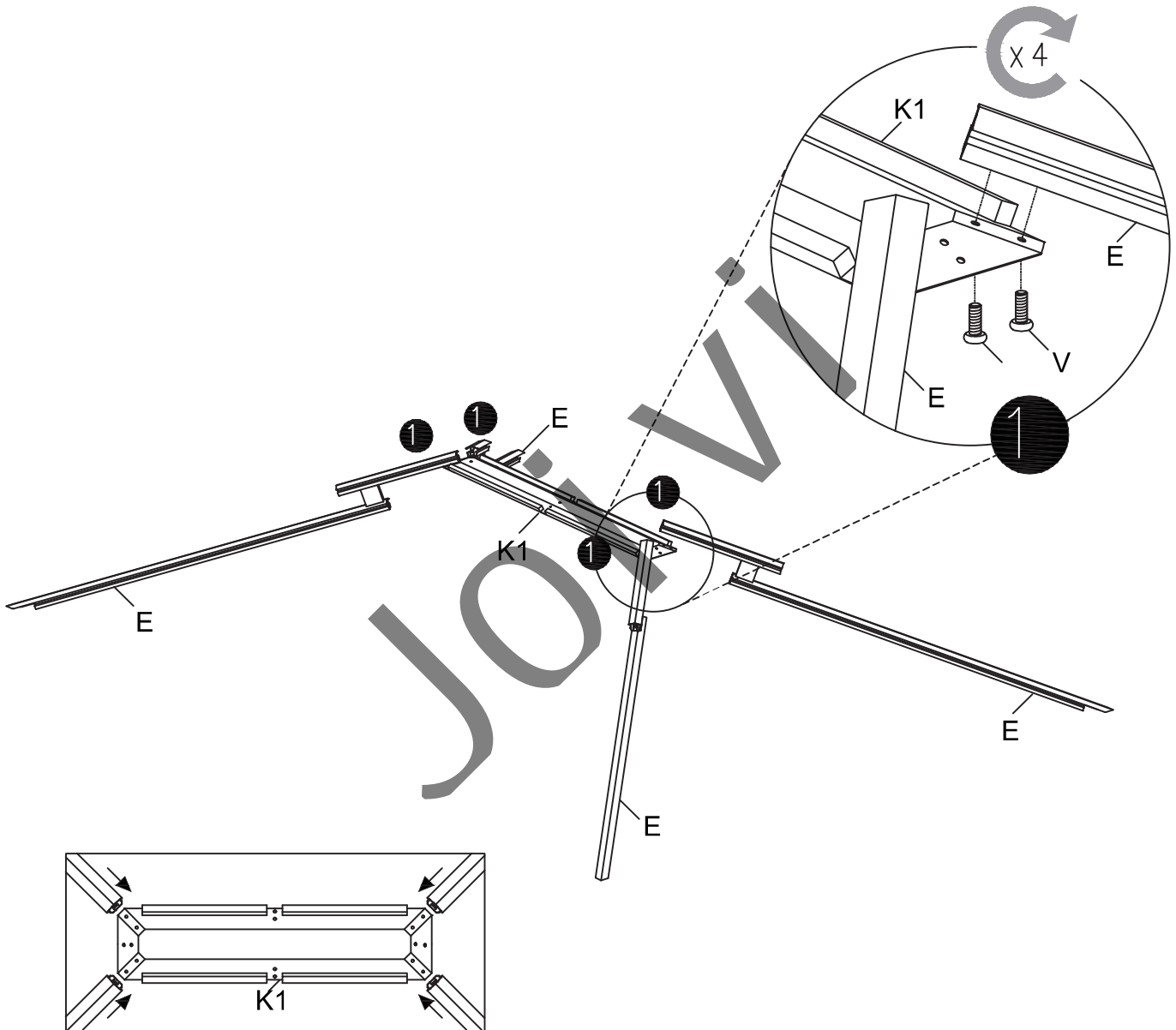

ASSEMBLY STEPS

11 Attach the connector rod (E) to Post (A) with bolt (V).

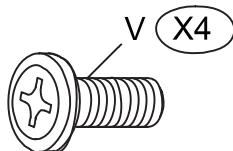
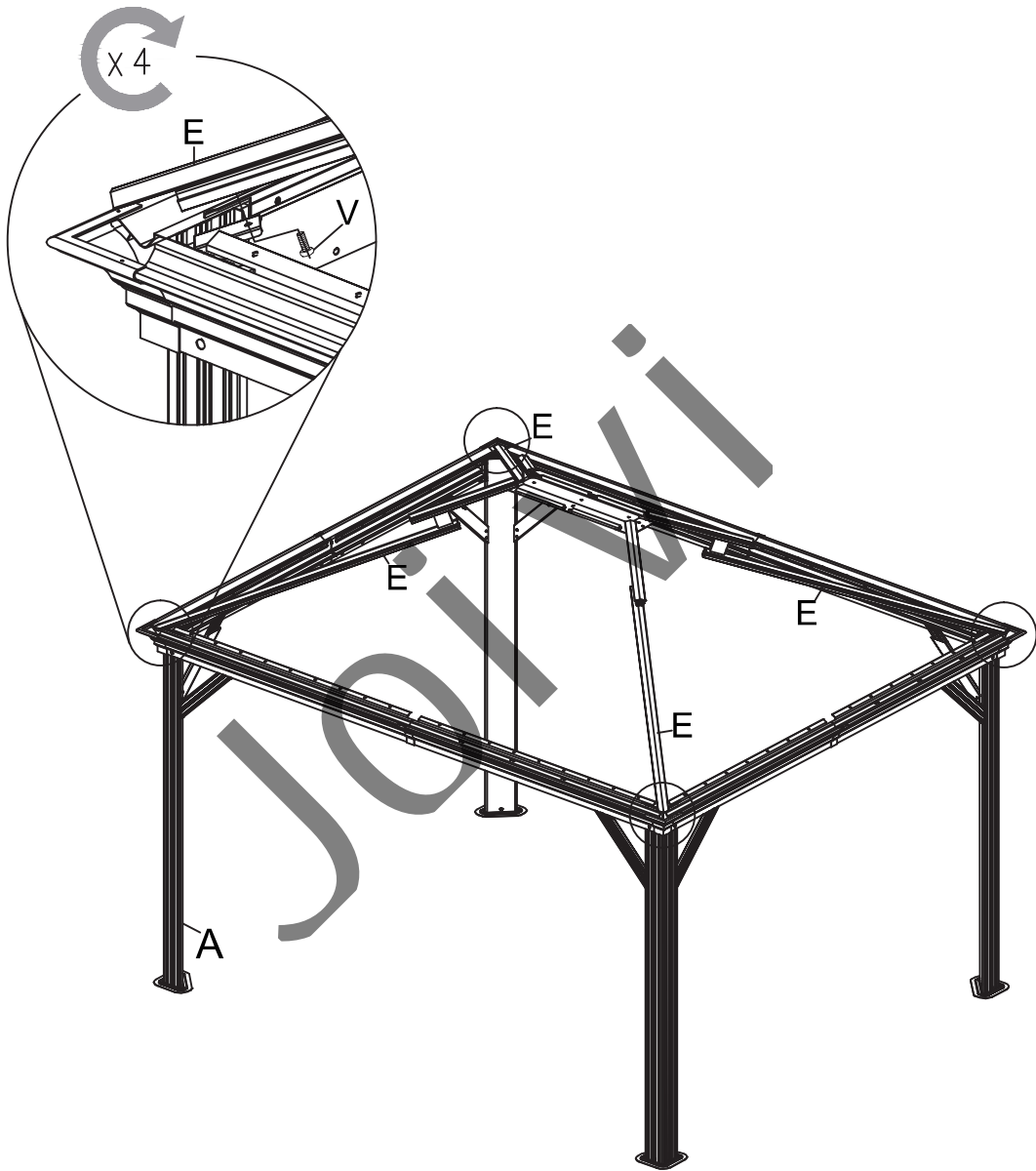

ASSEMBLY STEPS

- 12** Attach the connector rod (E1) to the assembled long beam (B & B1) and short beam (C & C1) with bolt (V).

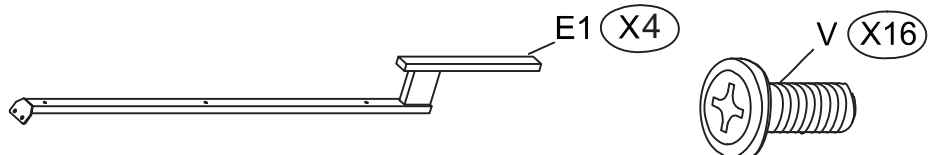
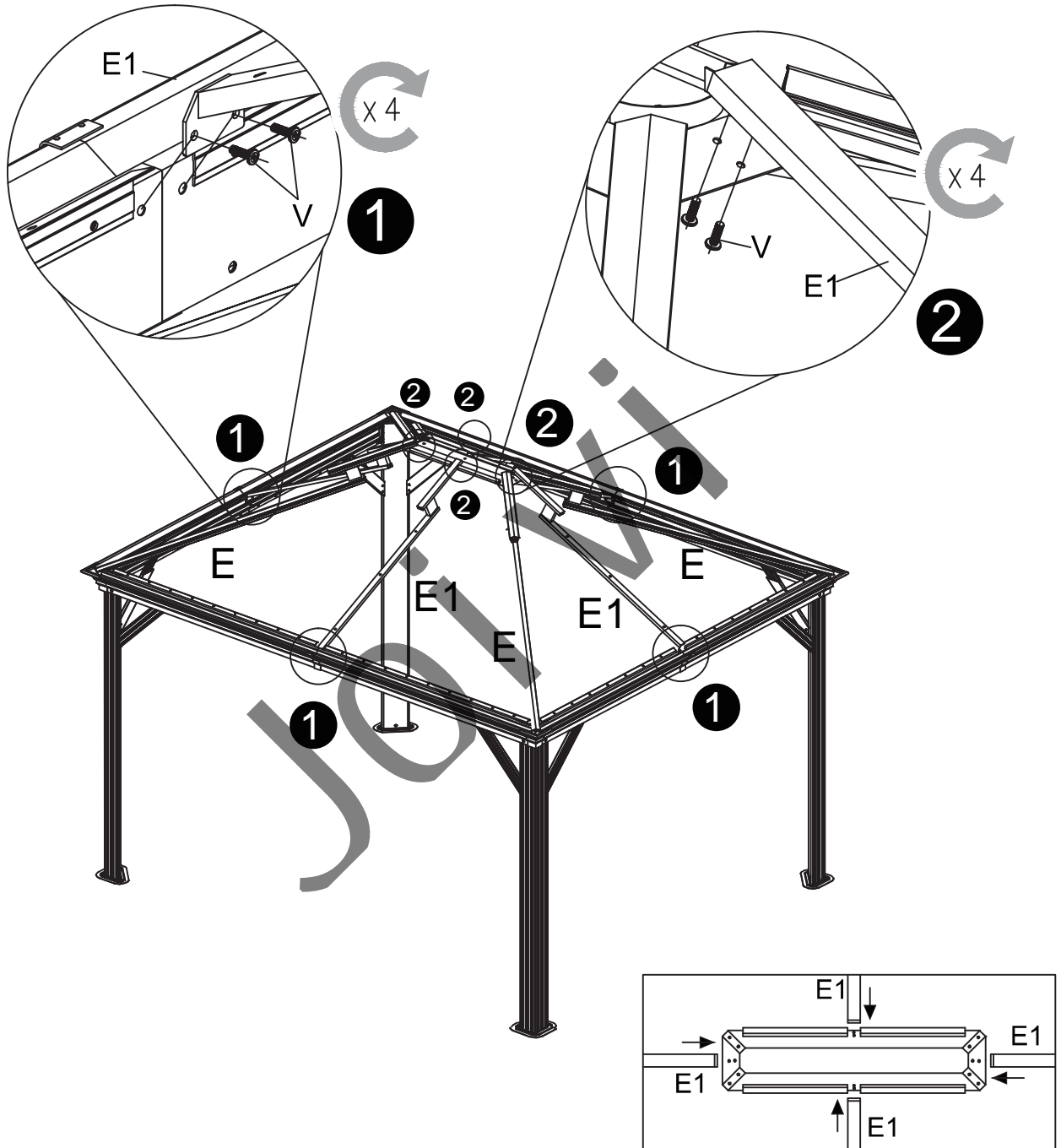

ASSEMBLY STEPS

13 Cover metal brackets (D1 & R) to roof panels.

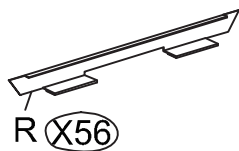
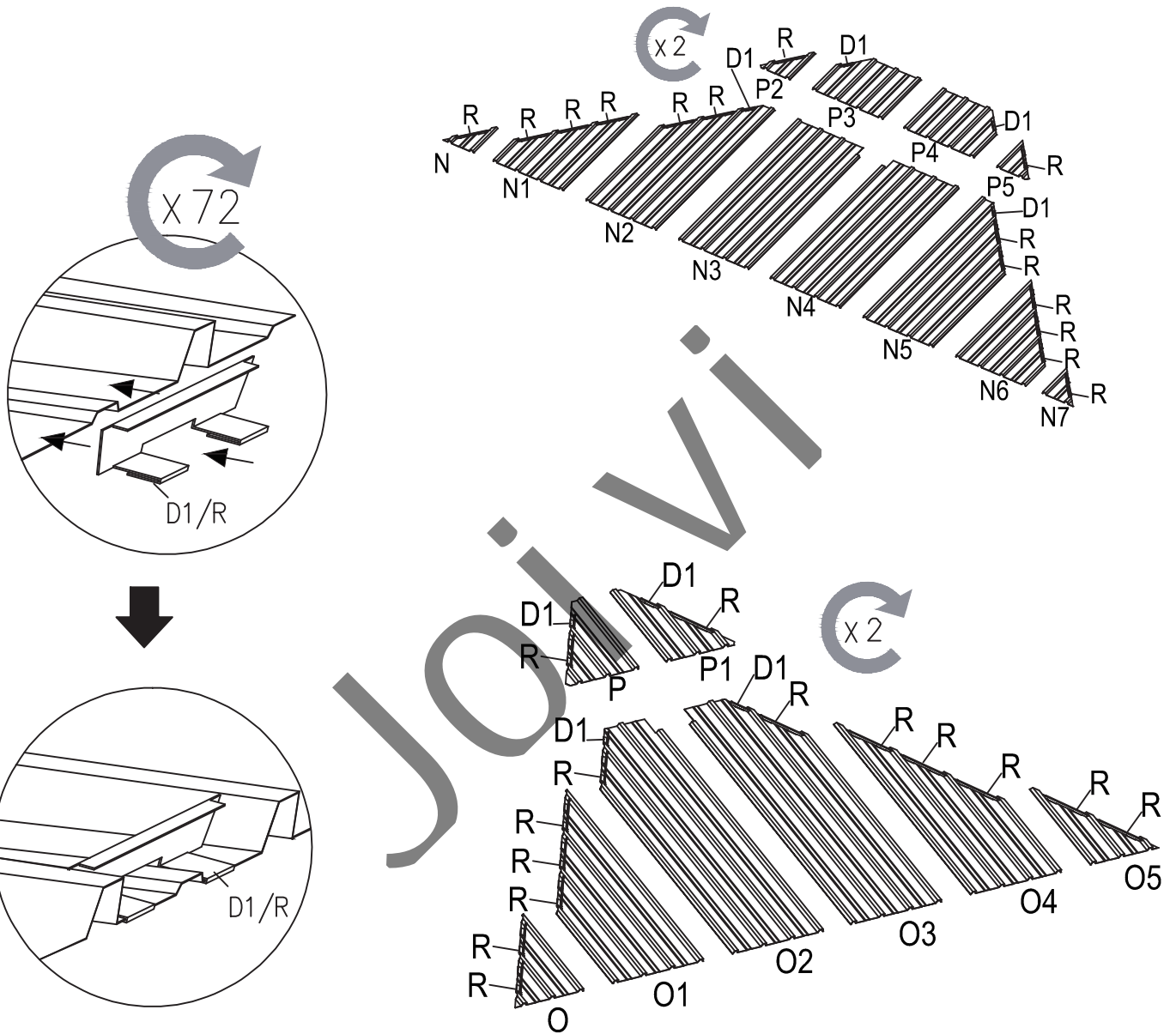

ASSEMBLY STEPS

- 14** Attach finishing bar (J & J1) with finish end (M2) with bolt (V) to the connector rod (E1) with bolt (V).

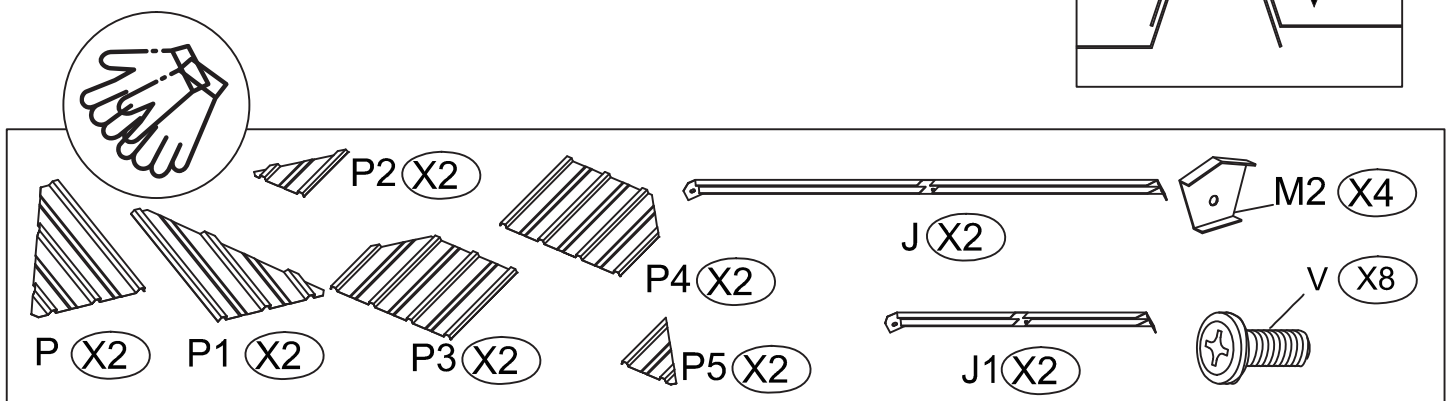
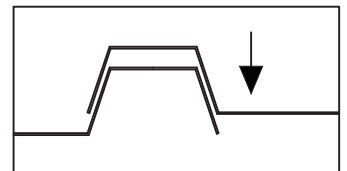
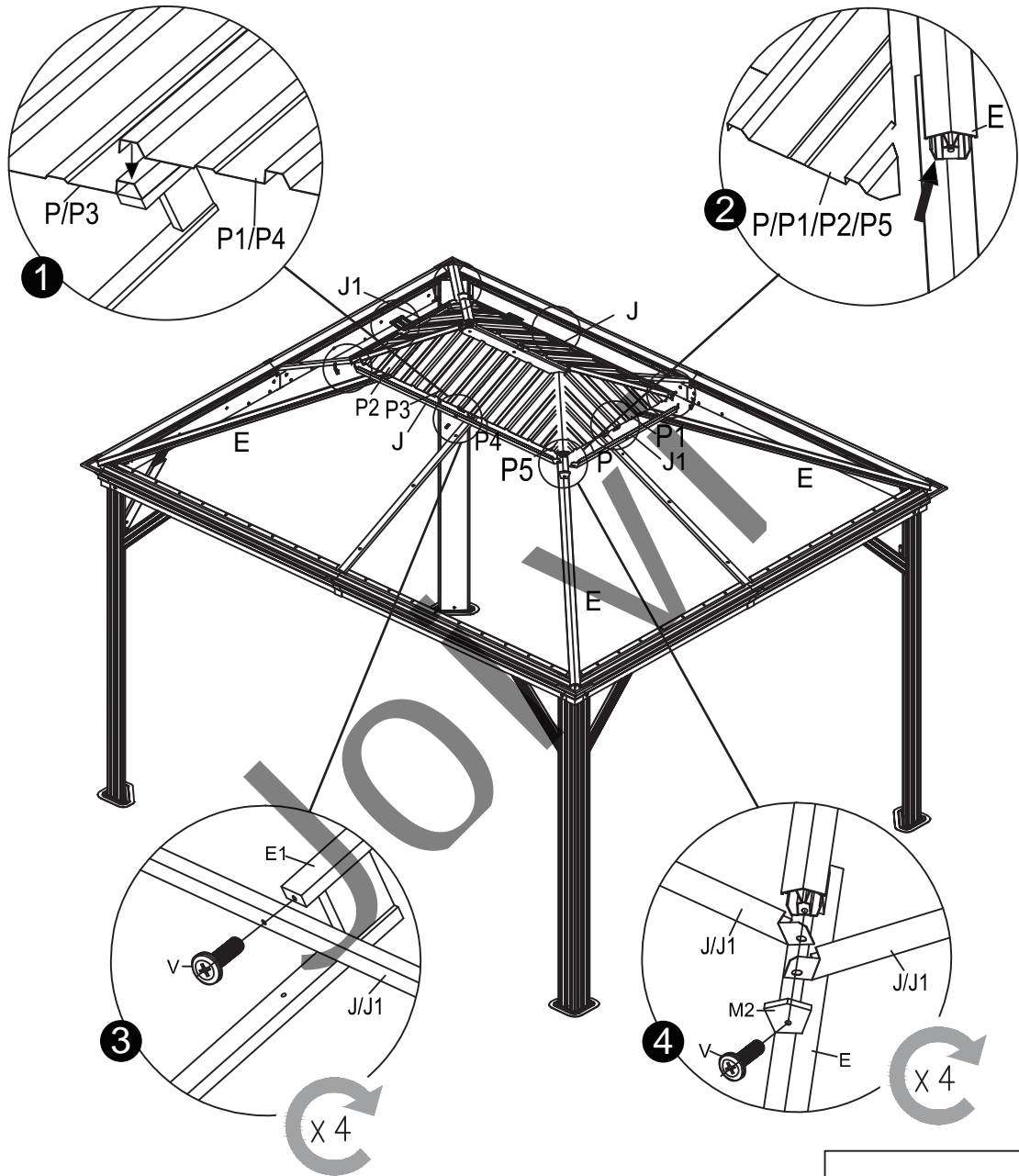

ASSEMBLY STEPS

- 15** Attach the corner protector (M2) to the frame rod (R2) & the connector rod (E) with bolt (V). Attach the connector rod (E1) to the frame rod (R1 & R2) with bolt (V). Attach the air plate (ZS1 & ZS2) with bolt (Y1).

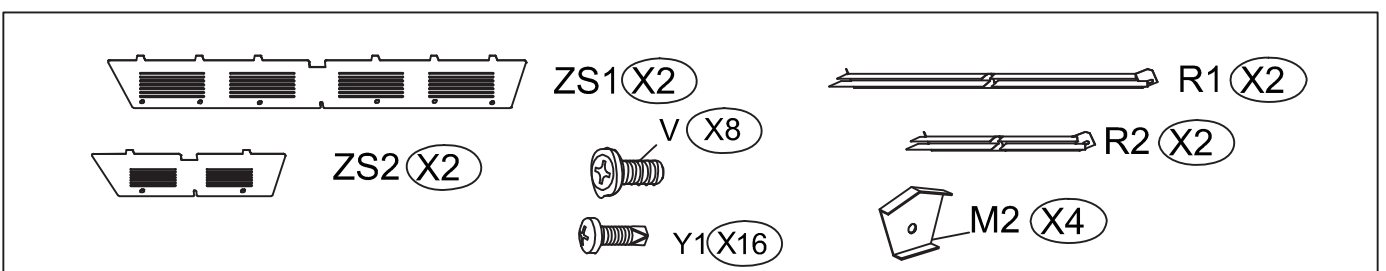
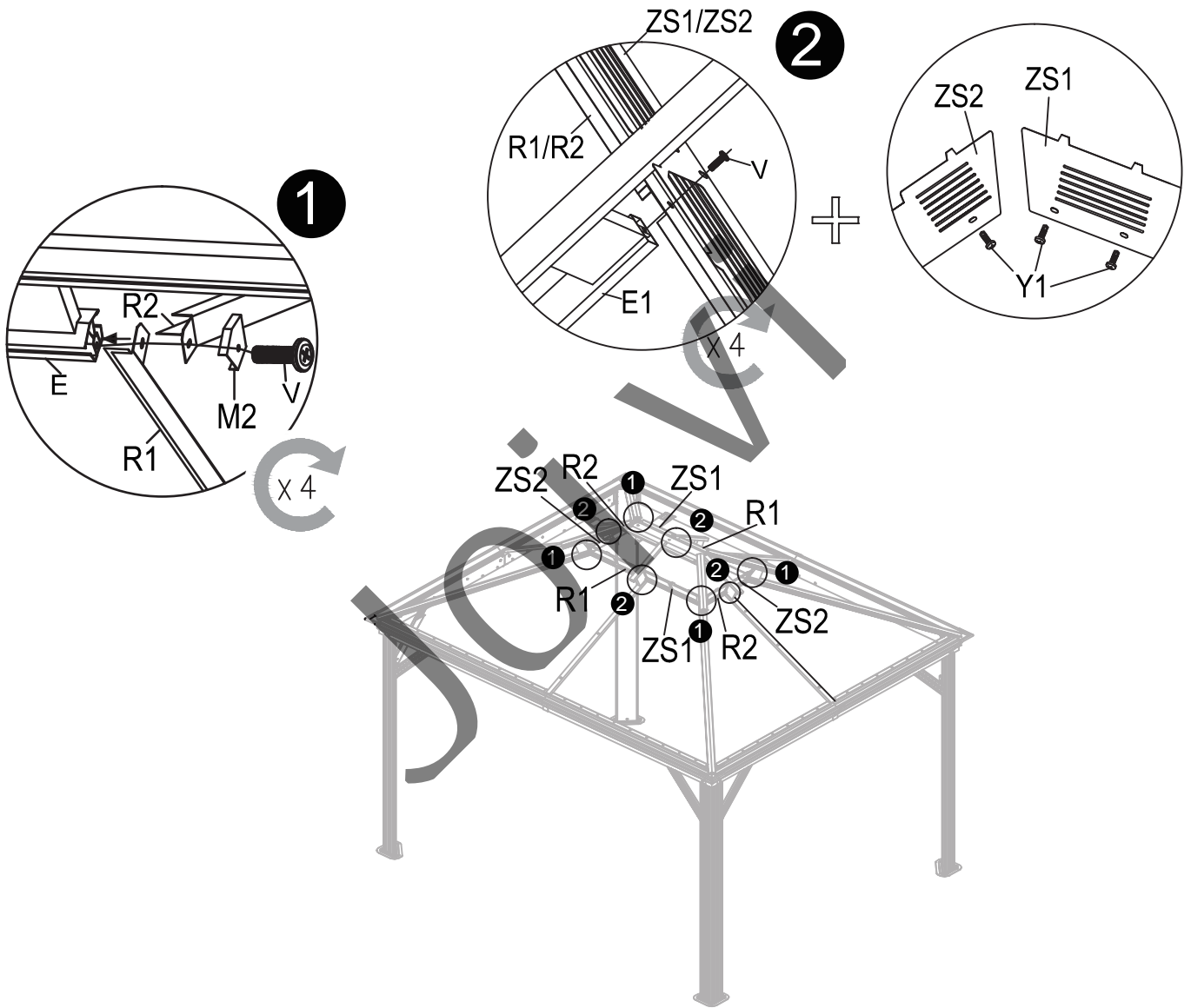

ASSEMBLY STEPS

- 16** Attach the small roof cover (K) to the small roof base (K1) with bolt (U).
Install the Hooks (Wa) to the small roof base (K1).

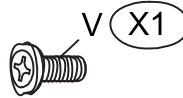
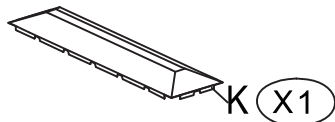
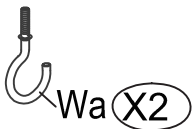
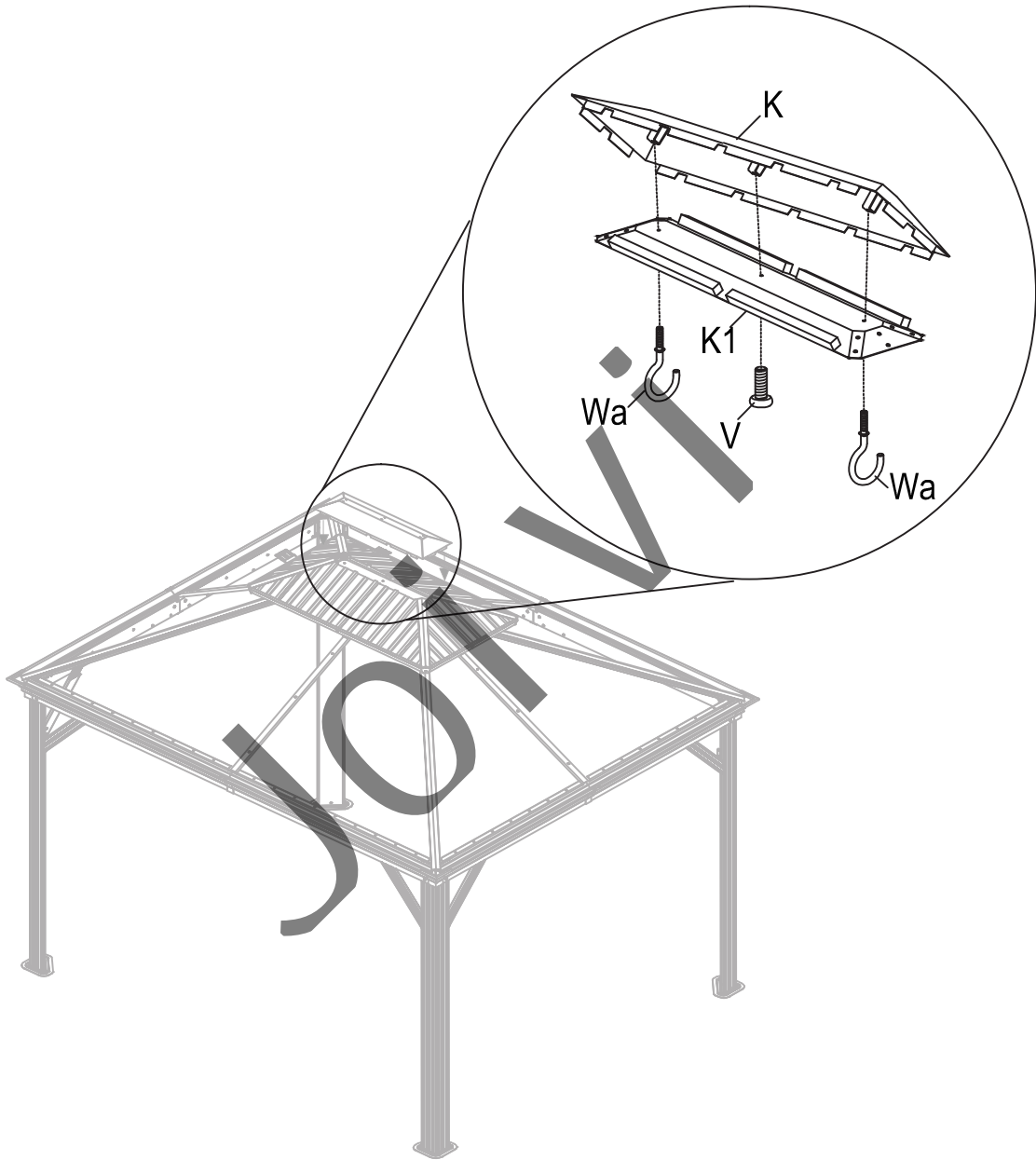

ASSEMBLY STEPS

- 17** Attach the roof supports (H & I) the connector rod (E & E1) with metal plate(M3 & M4) & bolt (V).

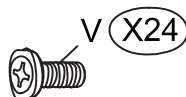
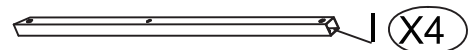
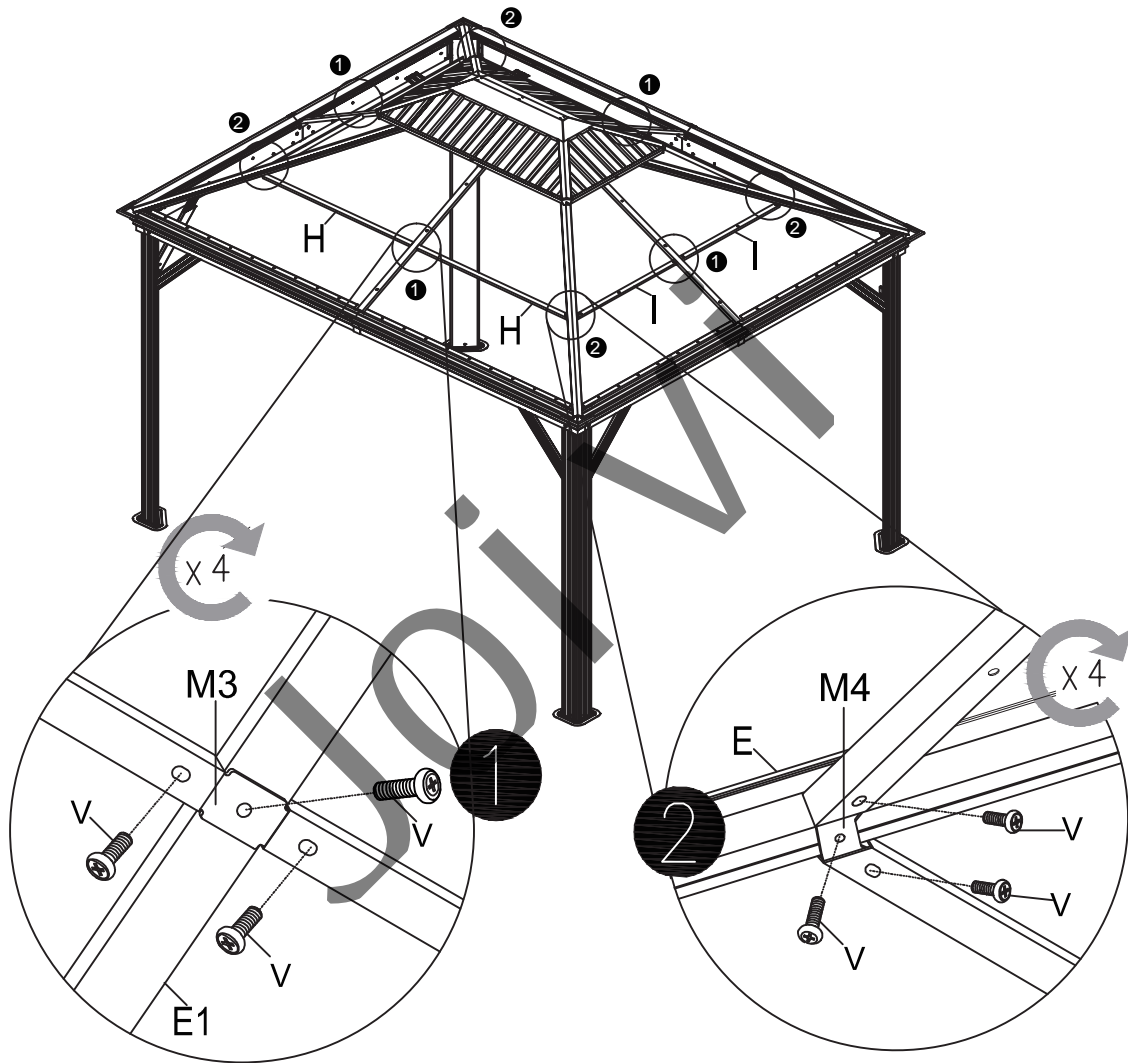

ASSEMBLY STEPS

18 Put the big Top Panel on the frame as per below picture.

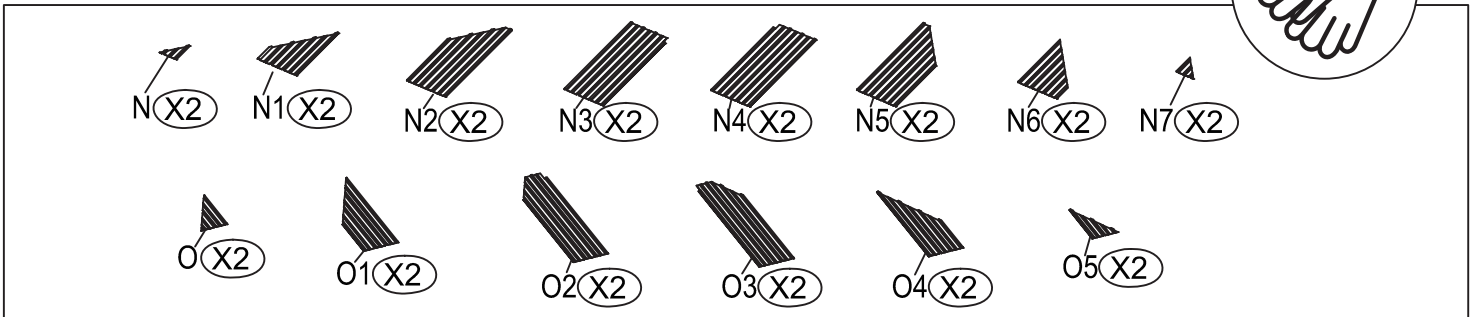
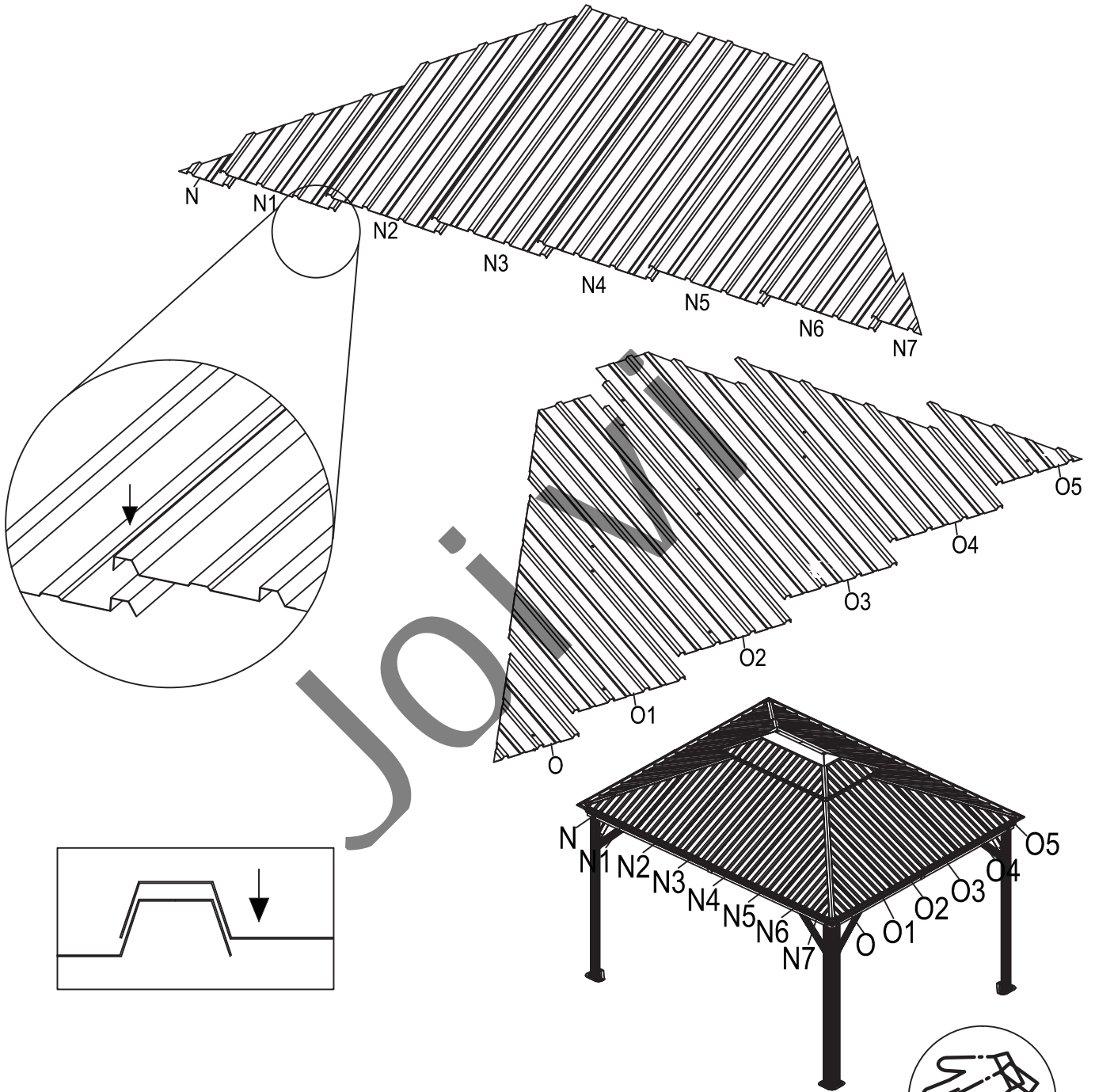

ASSEMBLY STEPS

19 Affix the roof panels with bolt (T & U & X1 & S).

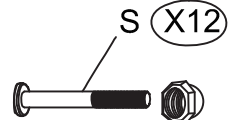
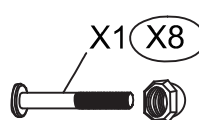
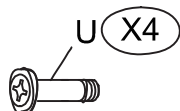
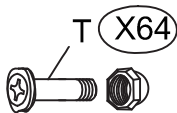
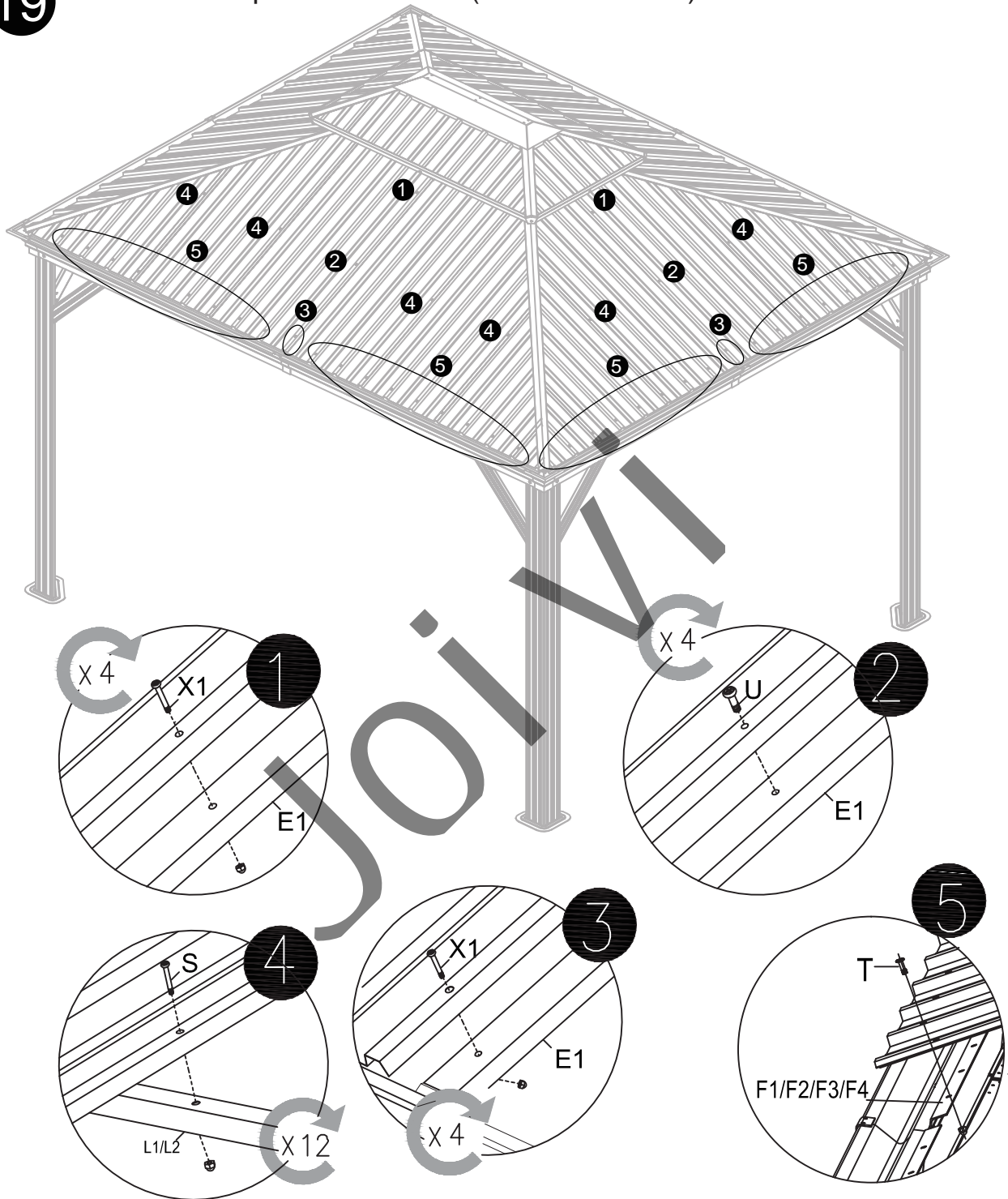

ASSEMBLY STEPS

20 Hang the curtains (NN) & netting (CC) onto hooks (Q).

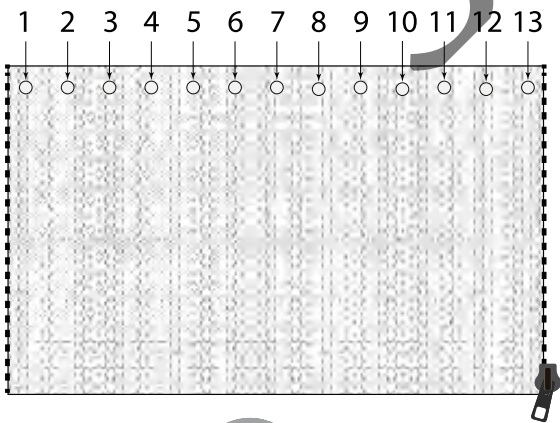
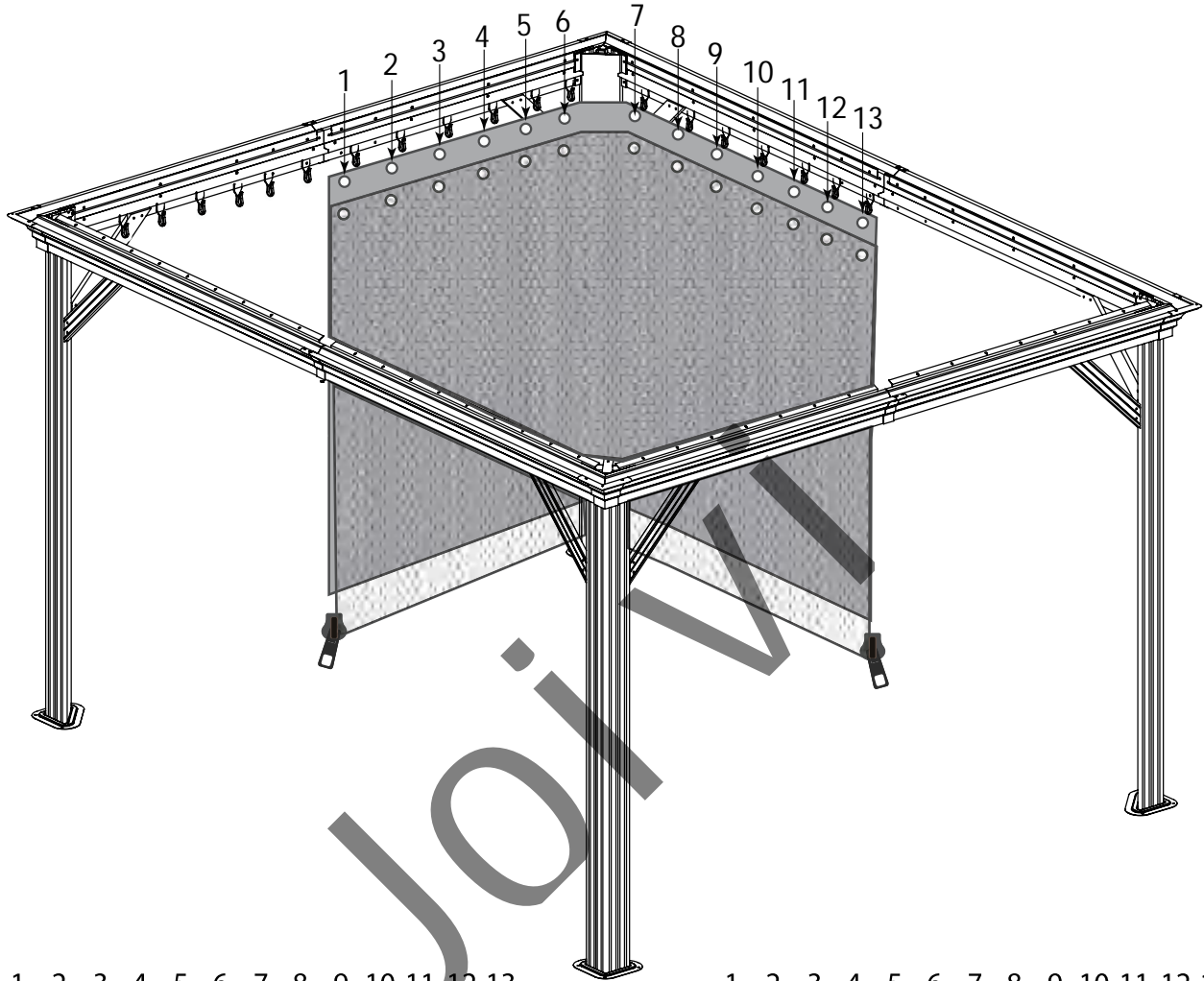

x 4

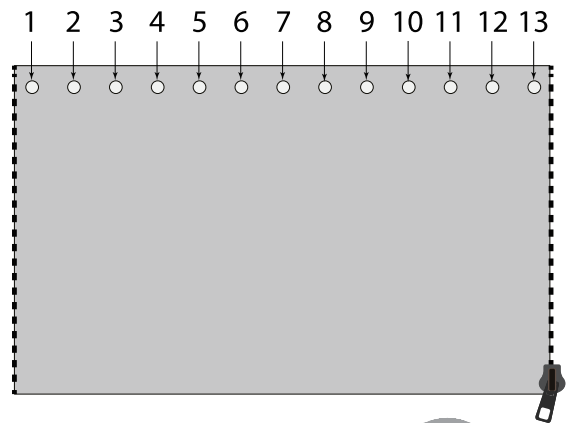

x 4

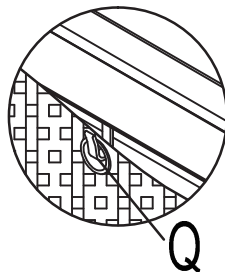

Q

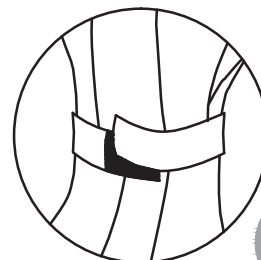

x 4