

# Jardína

Assembly instructions



# Hallerbos

Dining Table

# Safety and Care Advice

---

## IMPORTANT, RETAIN FOR FUTURE REFERENCE: READ CAREFULLY.

- Keep children and animals away from the work area. Small parts could choke if swallowed.
- Assemble the item as close to its final position (in the same room) as possible.
- Parts of the assembly will be easier with 2 people.
- Make sure you have enough space to layout the parts before starting.
- Assemble on a soft level surface to avoid damaging the unit or your floor.
- Dispose of all packaging carefully and responsibly.
- This product has been constructed to be used in the domestic environment only and not for commercial purposes.
- Remove all fittings from the plastic bags and separate them into their groups.
- We do not recommend the use of power drill/drivers for inserting screws as this could damage the unit. Only use hand screwdrivers.
- Make sure you have enough space to layout the parts before starting.
- Do not stand or put weight on the product during assembly, this could cause damage.

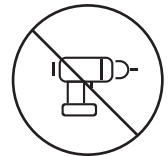

## Additional Guidance

- Assemble all parts and bolts loosely during assembly, only once the product is complete should you fully tighten the bolts.
- This product should not be discarded with household waste. Take to your local authority waste disposal centre.
- Regularly check and ensure that all bolts and fittings are tightened properly.
- Do not fully tighten all screws until assembly is completed.
- Only clean using a damp cloth and mild detergent, do not use bleach or abrasive cleaners.
- Make sure each screw matches the corresponding figure to ensure correct assembly.
- From time to time check that there are no loose screws on this product.

### Customer Support

 [www.Jardina.com](http://www.Jardina.com)

 [Service@Jardina.com](mailto:Service@Jardina.com)

# Components

## Product Details:



TIME



2 OF PEOPLE



DIFFICULTY

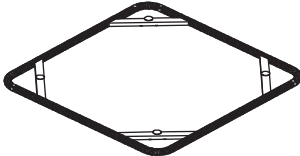

**A** Table Top Frame 1x

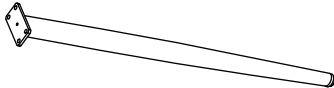

**B** Table Leg 4x

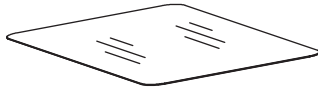

**C** Table Glass 1x

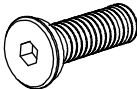

**D** Screw M6\*20 16x



**E** Washer 16x

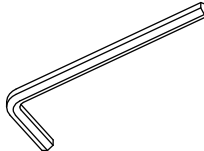

**F** Allen Key

# 1

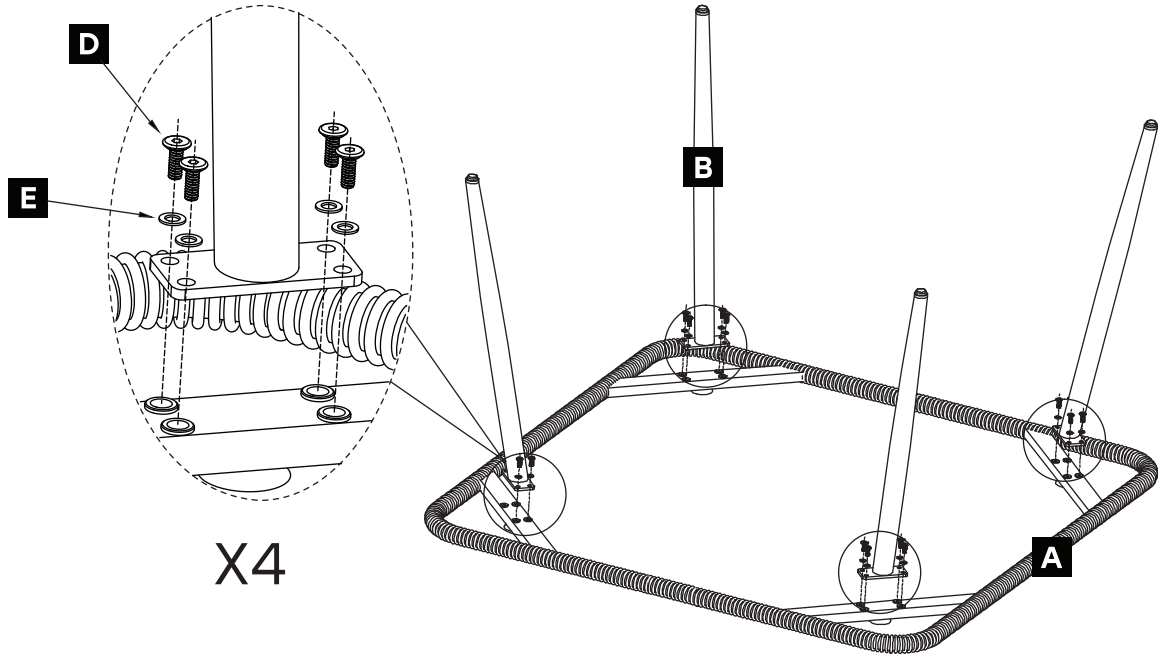
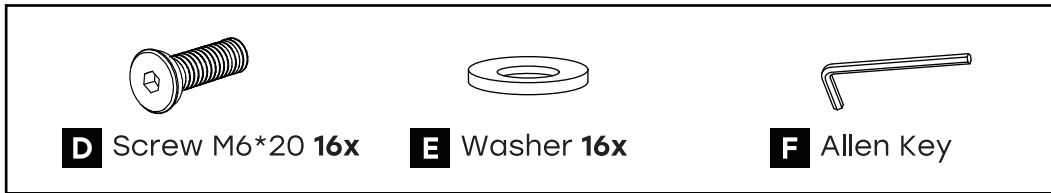

# 2

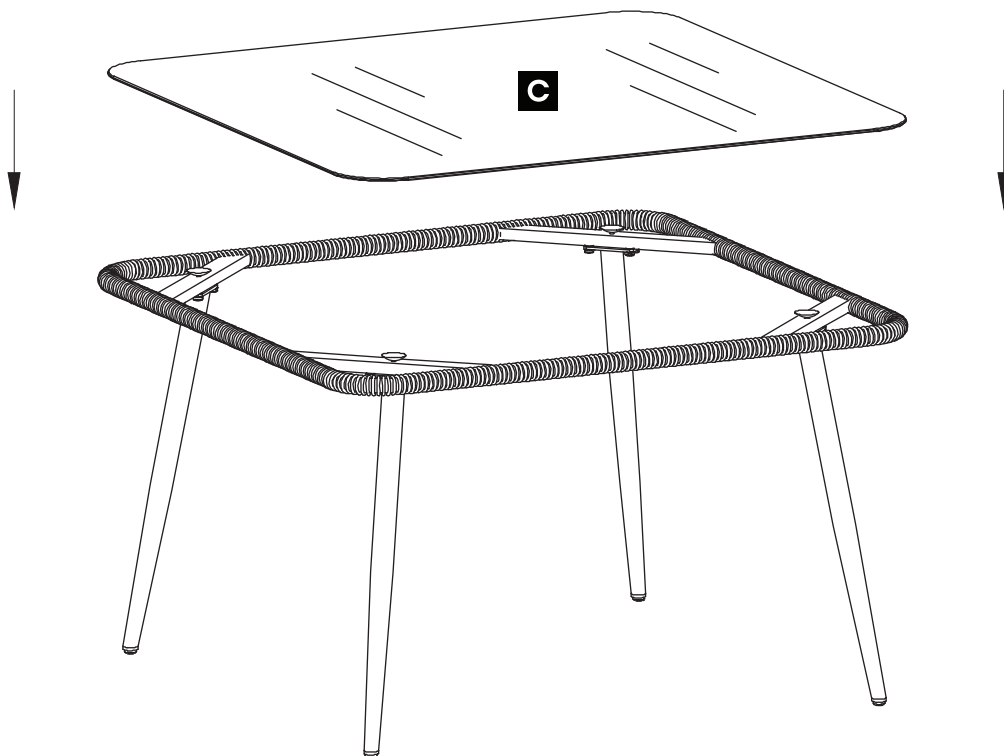

3

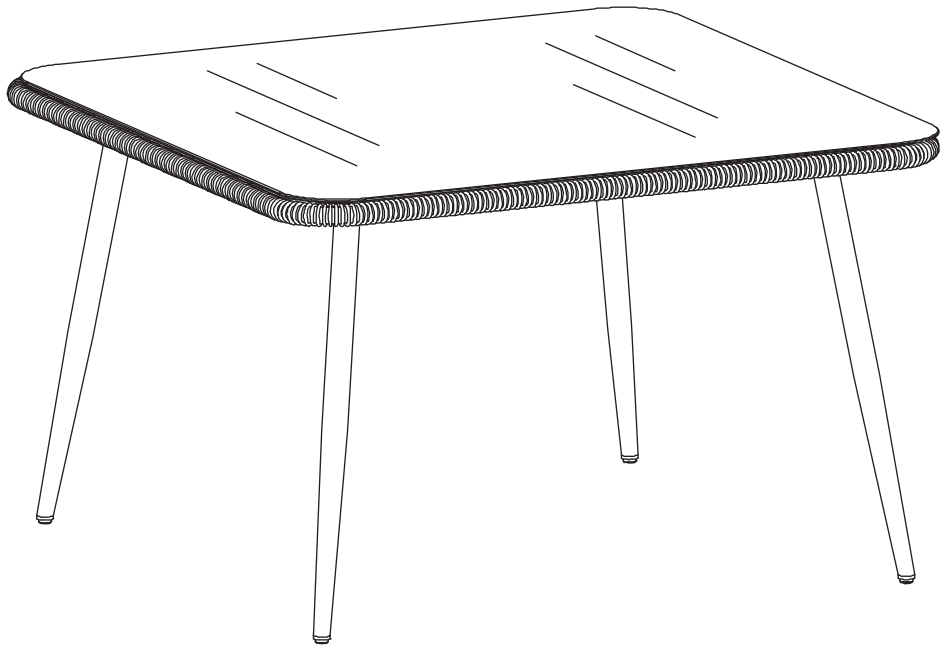

# Maintenance and Care Instructions

---

- This product may only be used for its intended purpose for residential premises. Any other uses may affect the warranty.
  - Jardina furniture is designed to be left outdoors all year round .
  - We recommend you clean your Jardina furniture at the beginning and end of the season. To clean your Jardina furniture, use warm soapy water only. Never use abrasive chemicals or cleaning agents. To lengthen the life of your product we recommend treating the rope using the fabric cleaner and protector and the frame using the Multi-surface cleaner from our aftercare range available to purchase from our website.
- Tree sap and bird droppings should be cleaned off immediately.
  - Moving parts such as locking mechanisms, catches and joints need to be lubricated where necessary.
  - Jardina furniture can be covered - we recommend that you use universal breathable covers.
  - This product is 100% recyclable. At the end of the products life, please dispose of responsibly.
  - Color may vary slightly.



## Attention

Please be aware that painted/varnished surfaces can be damaged by sunscreens and oil based products. If the surface of your Jardina outdoor furniture comes into contact with sunscreens, the surface is to be cleaned without delay as described above. Only in this way can lasting discolouration of the surface by the ingredients of the sunscreen be prevented.

# For Your Safety

---

- This product may only be used for its intended purpose as furniture for residential properties.
  - Check all components regularly for correct function, damage and loose connections especially at the start of the season and at 1-2 month intervals dependent on use.
  - Damaged components may endanger your safety or shorten the life of the product. Replace all damaged parts immediately. Use only spare parts manufactured by Jardina. Should you wish to purchase spare parts, you can contact us at **service@Jardina.com**
- Jardina will not be responsible for damaged caused by improper use.



## Attention

- Whilst assembling this product keep out of the reach of children. (Choking hazard contains small parts)
- Ensure that your working area is free of possible sources of danger, for example don't leave any tools lying around.
- Always dispose of packaging material in such a way that it may not cause any danger. There is always a risk of suffocation if children play with plastic bags!
- We reserve the right to make changes for technical reasons.

### Jardina 2 Years Warranty

This product is covered by a 2 year warranty against manufacturing faults. This warranty applies to domestic use only. It does not cover commercial use, mis-use or accidental damage.

2-year warranty is offered on the day of your purchase. More details in our website:  
**www. Jardina.com**

