

Jardína

Assembly instructions

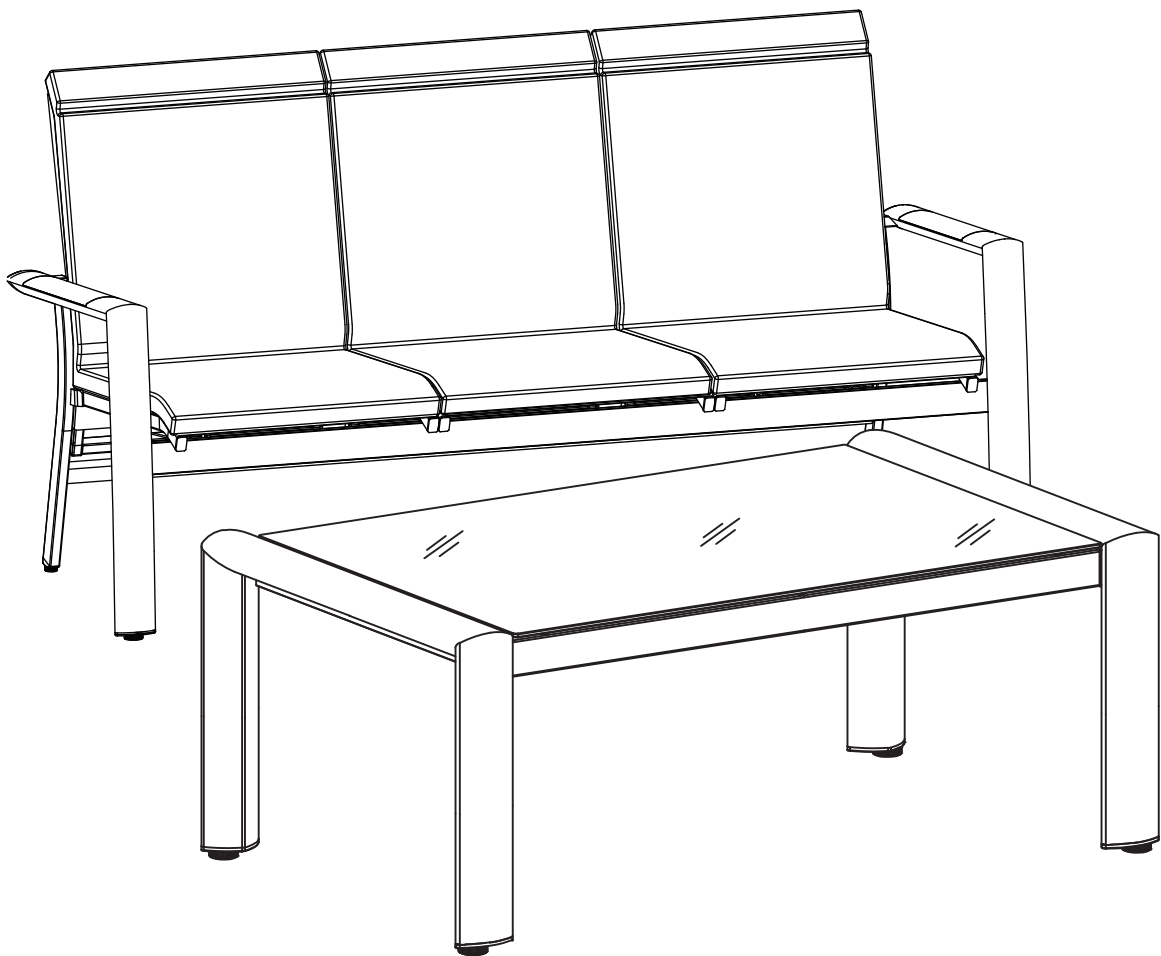

Capri
Sofa Set

Safety and Care Advice

IMPORTANT, RETAIN FOR FUTURE REFERENCE: READ CAREFULLY.

- Keep children and animals away from the work area. small parts could choke if swallowed.
- Make sure you have enough space to layout the parts before starting.
- This product has been constructed to be used in the domestic environment only and not for commercial purposes.
- Make sure you have enough space to layout the parts before starting.
- Assemble the item as close to its final position (in the same room) as possible.
- Assemble on a soft level surface to avoid damaging the unit or your floor.
- Remove all fittings from the plastic bags and separate them into their groups.
- Do not stand or put weight on the product during assembly, this could cause damage.
- Parts of the assembly will be easier with 2 people.
- Dispose of all packaging carefully and responsibly.
- We do not recommend the use of power drill/drivers for inserting screws as this could damage the unit. Only use hand screwdrivers.

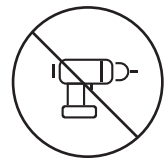

Additional Guidance

- Assemble all parts and bolts loosely during assembly, only once the product is complete should you fully tighten the bolts.
- Regularly check and ensure that all bolts and fittings are tightend properly.
- The unit weight approximately 65 Lbs.
- Do not fully tighten all screws until assembly is completed.
- Chair Maximum Safe Seated Weight: 350 Lbs
Table Weight Capacity: 110 Lbs.
- Only clean using a damp cloth and mild detergent, do not use bleach or abrasive cleaners.
- Make sure each screw matches the corresponding figure to ensure correct assembly.
- From time to time check that there are no loose screws on this chair.
- This product should not be discarded with household waste. Take to your local authority waste disposal centre.

Customer Support

 www.Jardina.com

 Service@jardina.com

Components

Product Details:



TIME



2 OF PEOPLE



DIFFICULTY

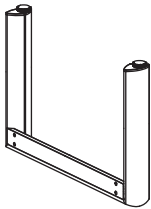

A Table Leg 2x

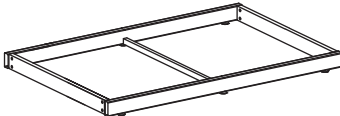

B Table Top 1x

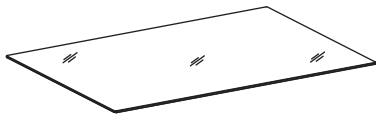

C Tempered Glass 1x

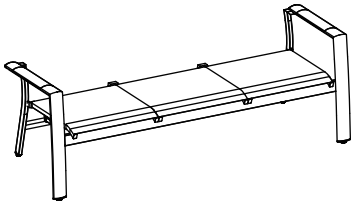

D Seat Base 1x

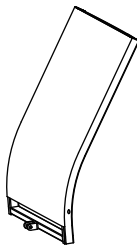

E Backrest 2x



F Middle Backrest 1x

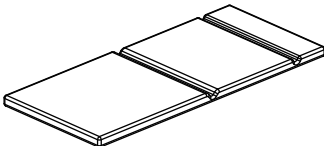

G Cushion 3x

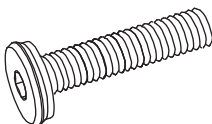

H Screw M6*30 8x

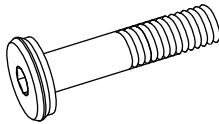

I Screw M6*40 8x

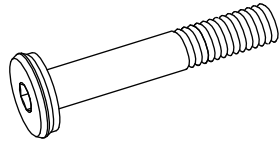

J Screw M8*50 **2x**

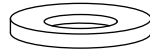

K Wahser **16x**



L Plastic Wahser
φ20*φ10 **4x**



M Plastic Wahser
φ16*φ6.5 **4x**

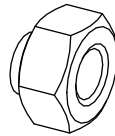

N Screw Nut M8 **2x**

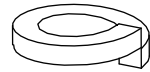

O Wahser M6 **4x**

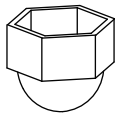

P Screw Cap φ17.5*17 **2x**

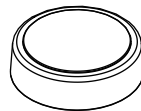

Q Screw Cap **18x**

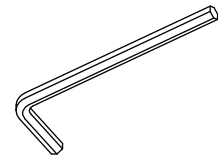

R Allen Key

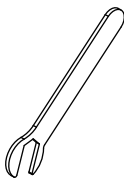

S Wrench M8

1

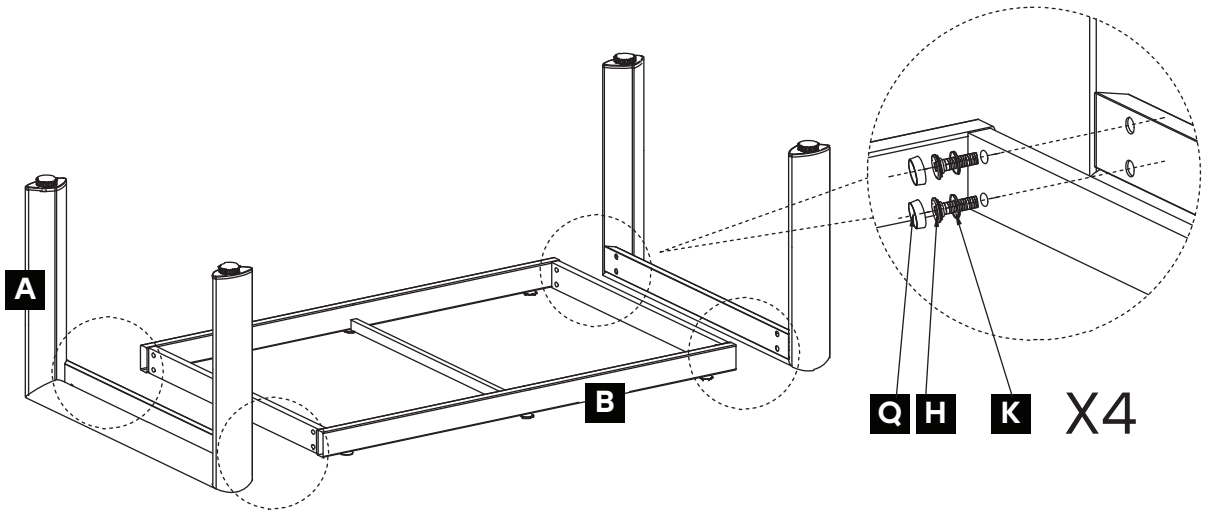
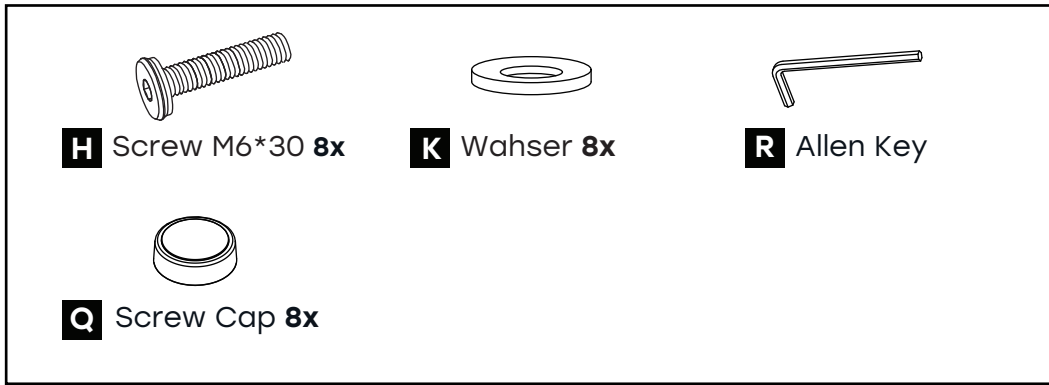

2

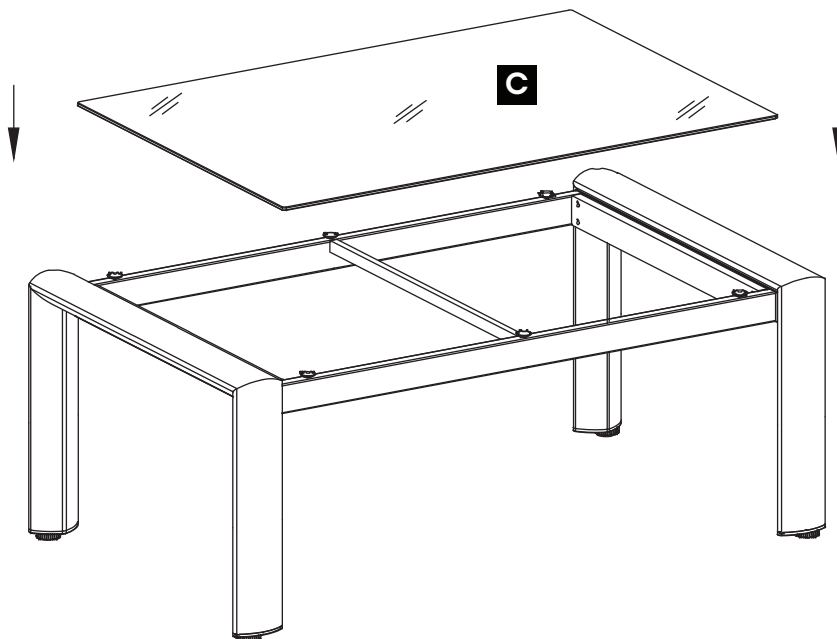
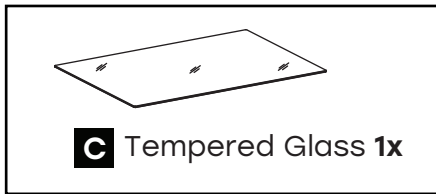

3

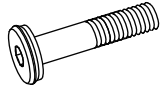

I Screw M6*40 4x



K Wahser 4x



R Allen Key



Q Screw Cap 4x

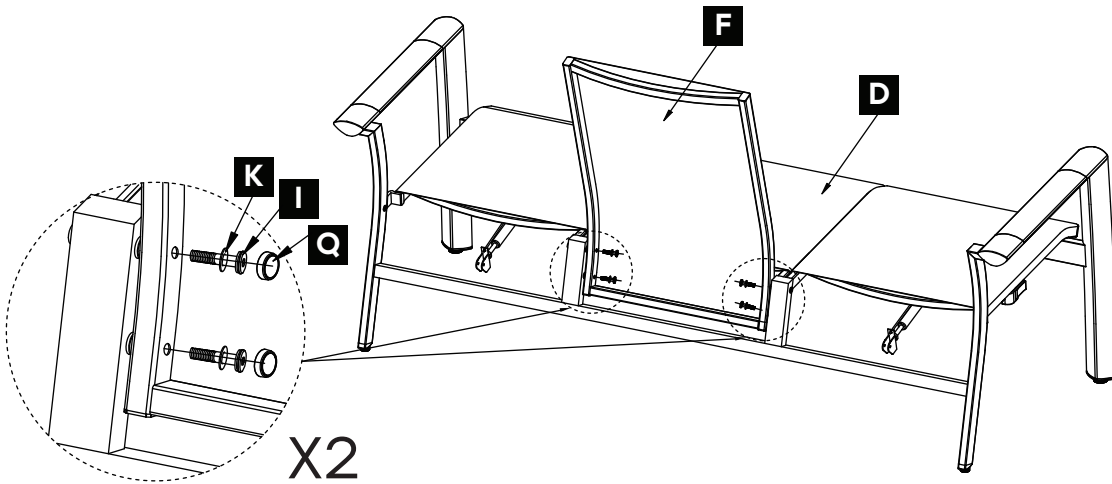

4

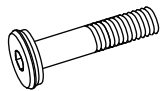

I Screw M6*40 4x



K Wahser 4x



M Plastic Wahser $\phi 16^* \phi 6.5$ 4x

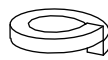

O Wahser M6 4x



R Allen Key



Q Screw Cap 4x

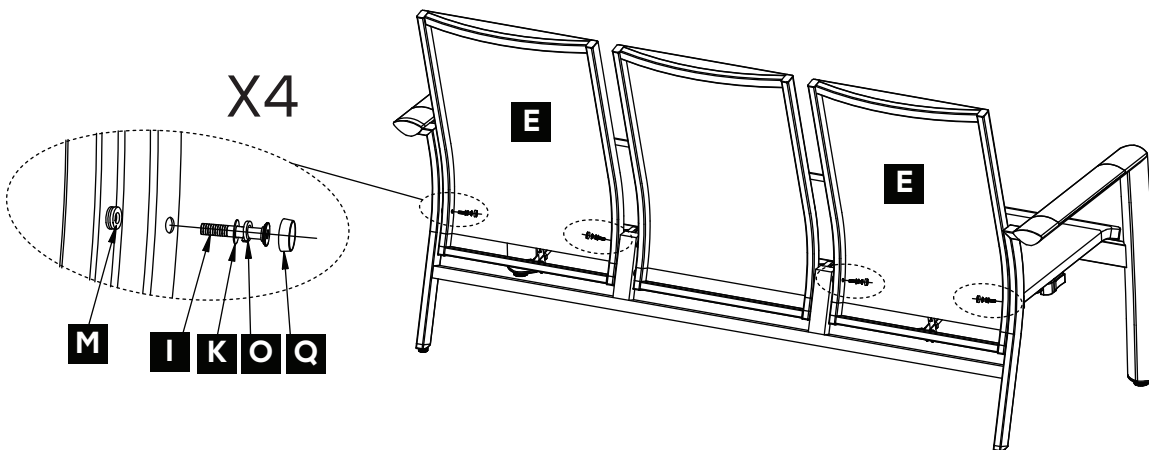

5

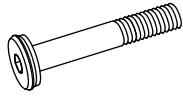

J Screw M8*50 2x



L Plastic Washer $\phi 20 * \phi 10$ 4x

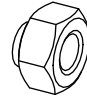

N Screw Nut M8 2x



P Screw Cap $\phi 17.5 * 17$ 2x



R Allen Key



S Wrench M8



Q Screw Cap 2x

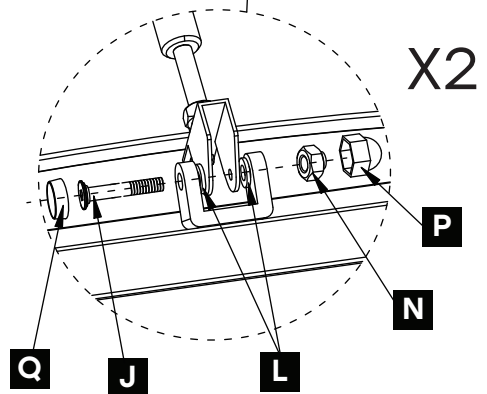
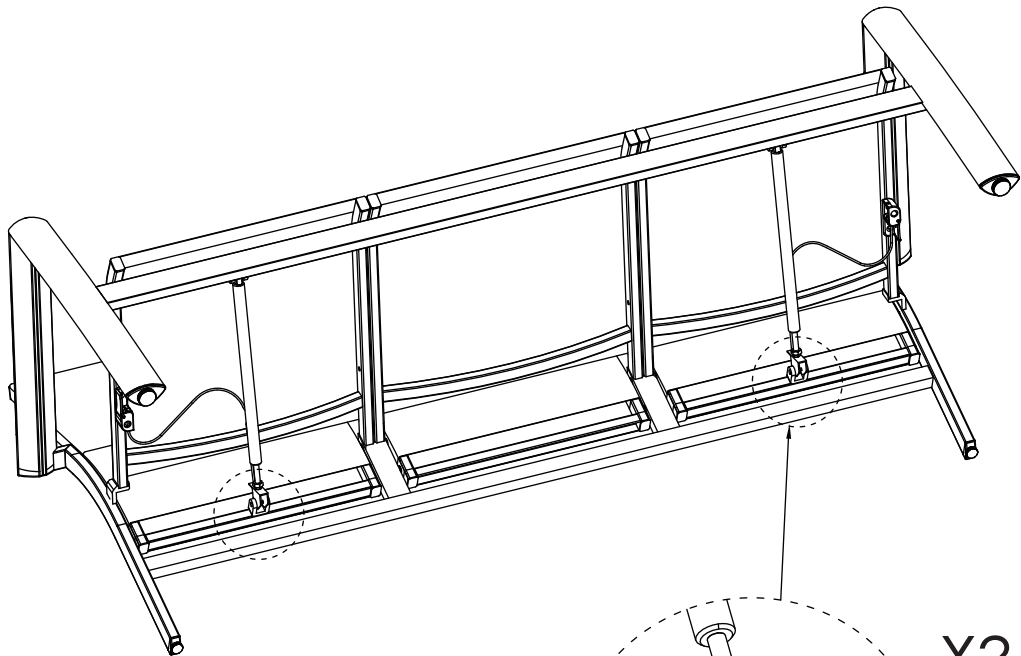

6

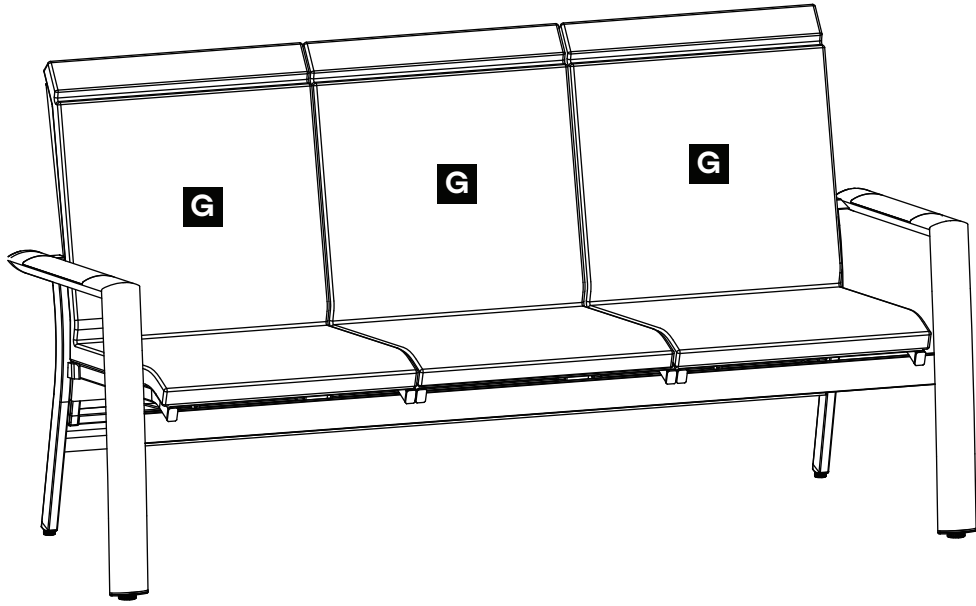

7

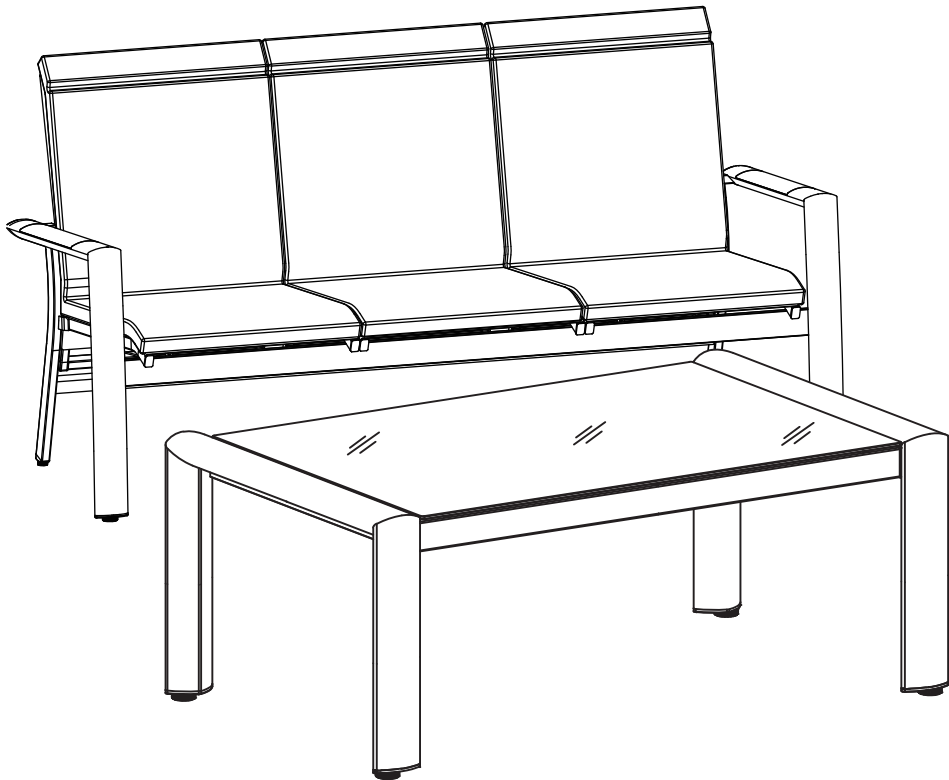

Turn on

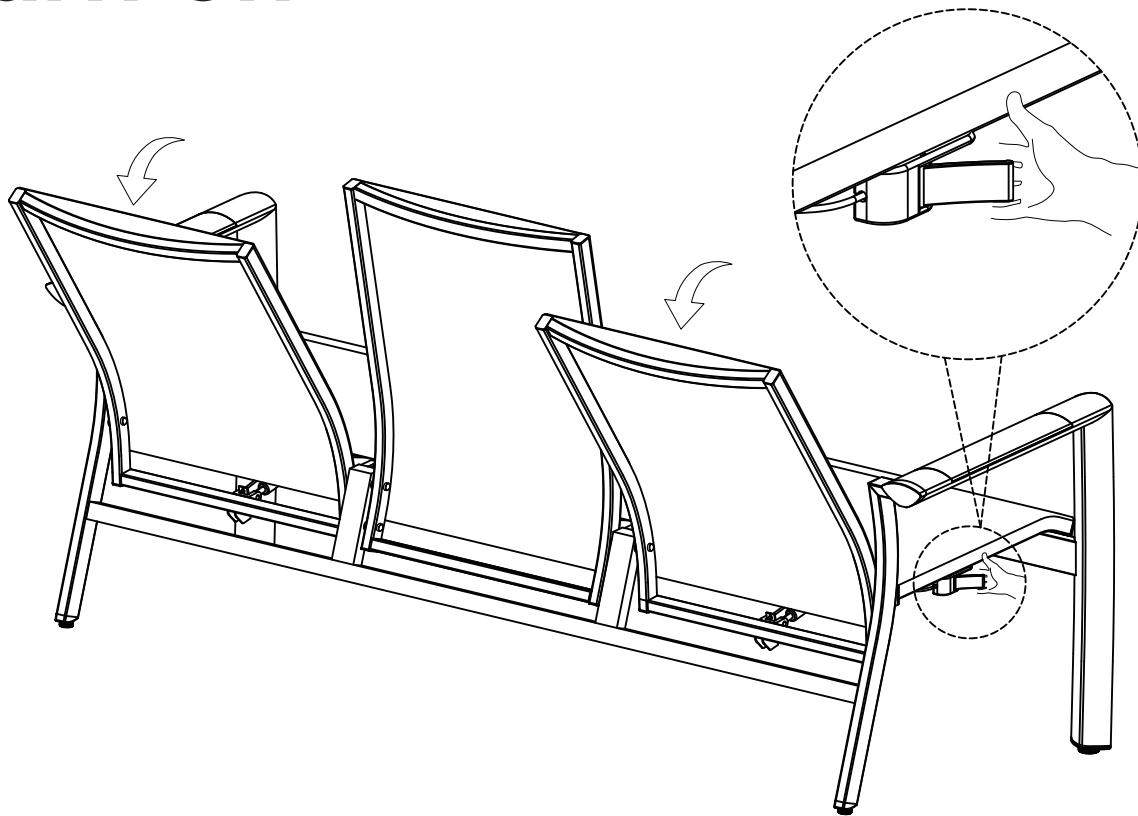

Turn off

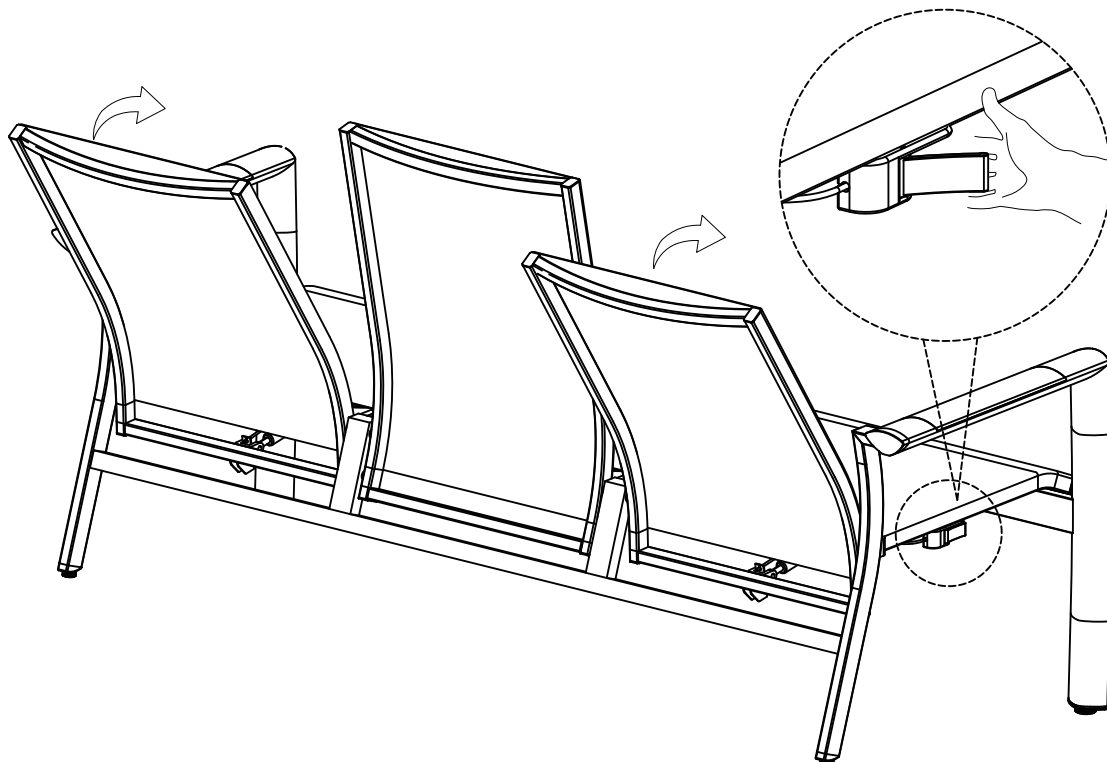

Maintenance and Care Instructions

- This product may only be used for its intended purpose for residential premises. Any other uses may affect the warranty.
- Jardina furniture is designed to be left outdoors all year round (excluding cushions). Cushions should be stored in a dry ambient temperature when not in use. Failure to comply with the outlined care instructions for the cushions will result in the warranty being invalidated.
- Jardina cushions are not suitable for dry cleaning and are not machine washable.
- Sponge clean only. We recommend the use of the Kettler fabric care kit to clean and protect your cushions. This is available to purchase from the Jardina website.
- We recommend you clean your Jardina furniture at the beginning and end of the season. To clean your Jardina furniture, use warm soapy water only. Never use abrasive chemicals or cleaning agents. To lengthen the life of your product we recommend treating the rope using the fabric cleaner and protector and the frame using the Multi-surface cleaner from our aftercare range available to purchase from our website. Tree sap and bird droppings should be cleaned off immediately.
- Moving parts such as locking mechanisms, catches and joints need to be lubricated where necessary.
- Jardina furniture can be covered - we recommend that you use Jardina tailored covers (where available) or universal breathable covers.
- This product is 100% recyclable. At the end of the product's life, please dispose of responsibly.
- Colours may vary slightly.



Attention

Please be aware that painted/varnished surfaces can be damaged by sunscreens and oil based products. If the surface of your Kettler leisure furniture comes into contact with sunscreens, the surface is to be cleaned without delay as described above. Only in this way can lasting discolouration of the surface by the ingredients of the sunscreen be prevented.

For Your Safety

- This product may only be used for its intended purpose as furniture for residential properties.
 - Check all components regularly for correct function, damage and loose connections especially at the start of the season and at 1-2 month intervals dependent on use.
 - Damaged components may endanger your safety or shorten the life of the product. Replace all damaged parts immediately. Use only spare parts manufactured by Jardina. Should you wish to purchase spare parts, they can be ordered directly from: www.Jardina.com
- Jardina will not be responsible for damaged caused by improper use.



Attention

- Whilst assembling this product keep out of the reach of children. (Choking hazard contains small parts)
- Ensure that your working area is free of possible sources of danger, for example don't leave any tools lying around.
- Always dispose of packaging material in such a way that it may not cause any danger. There is always a risk of suffocation if children play with plastic bags!
- We reserve the right to make changes for technical reasons.

Jardina 2 Years Warranty

This product is covered by a 2 year warranty against manufacturing faults. This warranty applies to domestic use only. It does not cover commercial use, mis-use or accidental damage.

To validate your warranty, register at www.Jardina.com and quote the product code from the front of this booklet.

