

## TUNGSTEN SMART-HEAT™ ELECTRIC

---

Our Tungsten Smart-Heat™ Electric series offers high performance radiant heating to outdoor and semi-enclosed spaces alike, with an industrial design style. It also boasts a high-temperature coating to suit all environments. With a stainless-steel construction, its durable element will emit a soft red glow to create a warm ambience in your space.

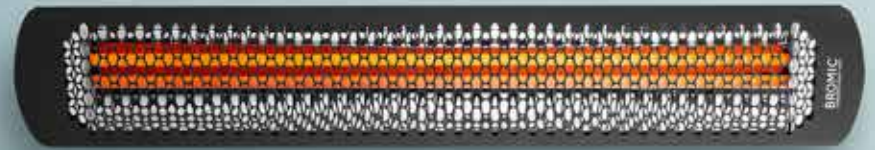

2000W / 3000W / 4000W / 6000W  
BLACK

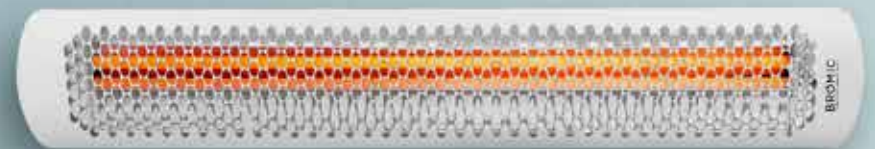

4000W & 6000W  
WHITE

# SPECIFICATIONS

Reference the specification guide below to help you select the correct solution for your needs.

MODEL NUMBER	2000 SERIES	3000 SERIES	4000 SERIES	6000 SERIES
PRODUCT CODE	BH0420030	BH0420031	BH0420032 BH0420034 BH0420012	BH0420033 BH0420035 BH0420013
FUEL TYPE	ELECTRIC	ELECTRIC	ELECTRIC	ELECTRIC
COLOR	BLACK	BLACK	BLACK   WHITE	BLACK   WHITE
HEAT AREA	65FT <sup>2</sup>	100FT <sup>2</sup>	130FT <sup>2</sup>	160FT <sup>2</sup>
RATED CURRENT **	240V/8.3A 208V/9.62A 277V/7.22A	240V/12.5A 208V/14.42A 277V/10.83A	240V/16.6A 208V/19.23A 277V/14.44A	240V/25A 208V/28.85A 277V/21.66A
MINIMUM FLOOR CLEARANCE	WALL 72"   CEILING 96"		WALL 72"   CEILING 96"	

## MOUNTING OPTIONS

CEILING MOUNT	✓	✓	✓	✓
CEILING RECESS KIT PRODUCT CODES	BH8180010	BH8180011	BH8180010	BH8180011
WALL MOUNT	✓	✓	✓	✓
RECESSED   FLUSH MOUNT	✓	✓	✓	✓
CEILING POLE MOUNT	✓	✓	✓	✓
TUBE SUSPENSION KIT (36") PRODUCT CODE	BH8180012			
FREESTANDING	-	-	-	-

## CONTROL OPTIONS

ON   OFF	✓	✓	✓	✓
ON   OFF PRODUCT CODE	BH3130010-1			
DIMMER	✓	✓	✓	✓
DIMMER PRODUCT CODE	BH3130011-1			
MASTER REMOTE *	✓	✓	✓	✓
MASTER REMOTE PRODUCT CODE	BH3130012			

Measurements displayed within this catalog are minimum requirements for installation. Bromic takes no responsibility for incorrect or non-compliant installations. All measurements in this document are displayed in inches.

\* Control up to six zones of heaters with unlimited heaters per zone from a single remote control. Dimmer control required. Works with dimming controllers. Remote control operates within 100ft of heaters.

\*\* Available in varying voltages: 240V, 208V and 277V

# DIMENSIONS

With a wide range of sizes available, find the ideal heater to suit your outdoor space.

## PROFILE

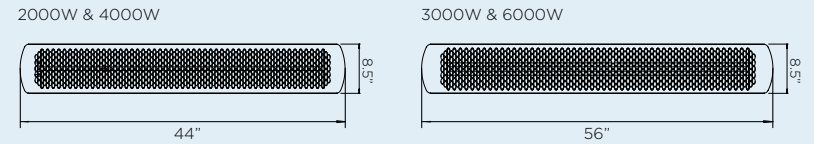

## CEILING RECESS

CEILING RECESS FRAME 2000W & 4000W

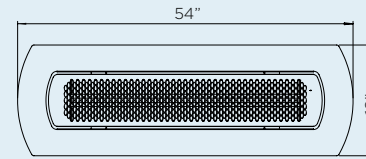

CEILING RECESS FRAME 3000W & 6000W

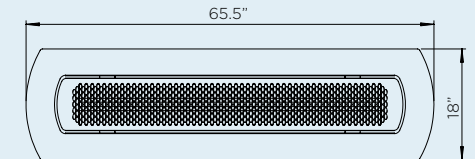

## CEILING RECESS

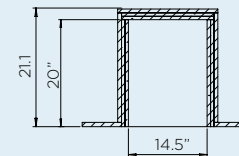

MINIMUM CEILING CAVITY

2000W & 4000W

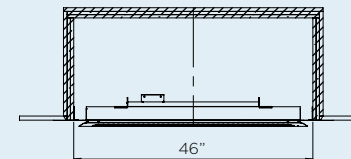

3000W & 6000W

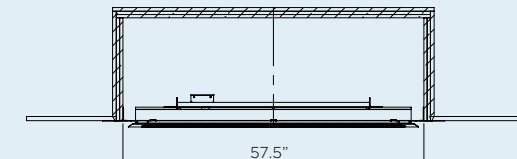

# MOUNT OPTIONS

With a wide array of mounting options, Bromic offers solutions to complete any decor and provide functionality for ambiance and comfort.

## CEILING & WALL MOUNT

### CEILING MOUNT CLEARANCE

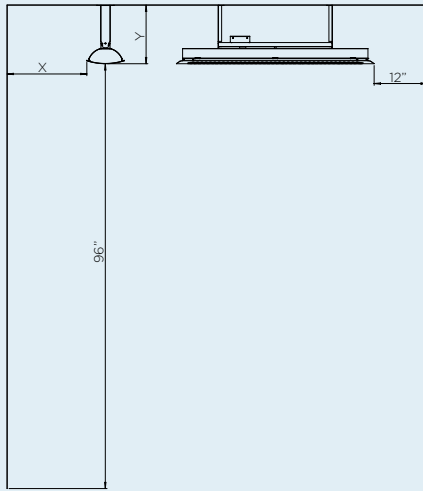

HEATER SIZE	X	Y	W	Z
2000 & 3000 W	12"	10"	5"	45°
4000 & 6000 W	18"	13"	12"	30°

### CEILING POLE CLEARANCE

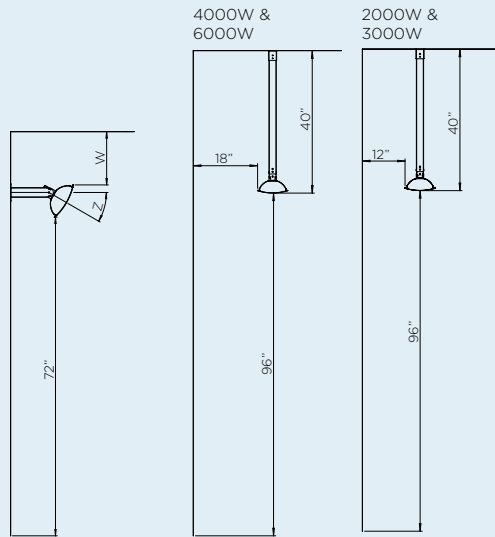

## WALL BRACKET

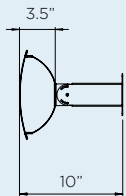

2000W & 3000W

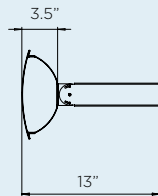

4000W & 6000W

# HEATING REACH

Creating ideal comfort levels, Bromic heaters offer a variety of heat distribution to suit your outdoor heating needs.

## 2000W & 4000W SERIES

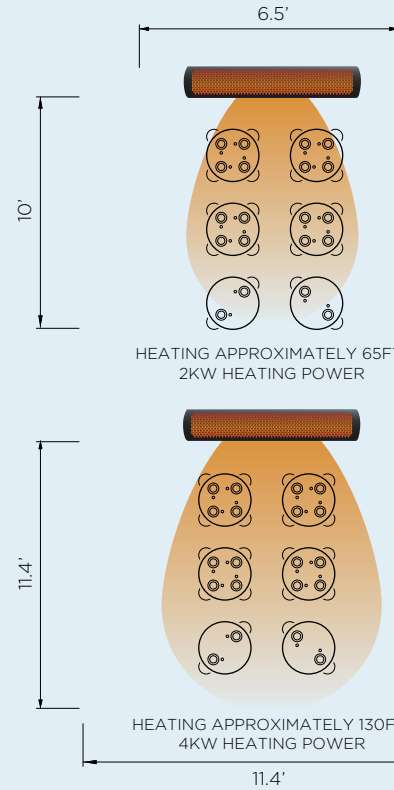

## 3000W & 6000W SERIES

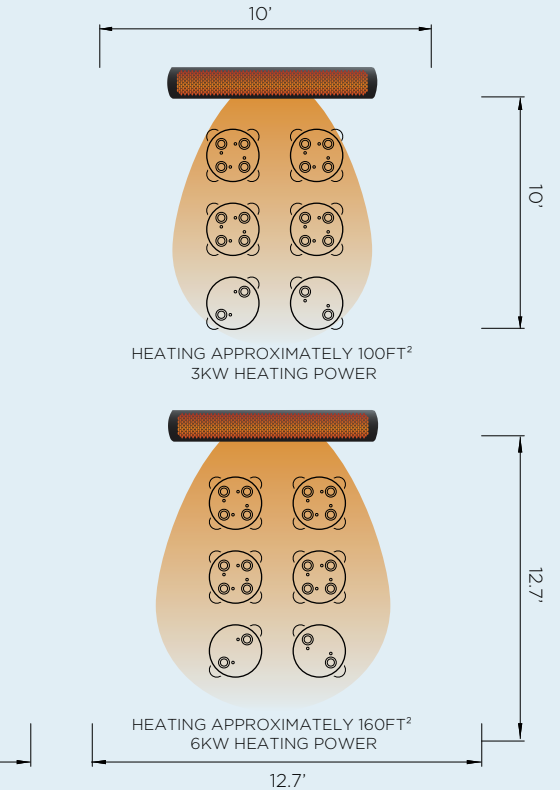

## CONTROL OPTIONS



ON | OFF CONTROL



DIMMER CONTROL



MASTER REMOTE



EXTEND YOUR COMFORT OUTDOORS  
WITH THE SUPERIOR HEAT AND  
AWARD-WINNING DESIGN OF OUR  
SMART-HEAT™ OUTDOOR HEATERS.

**HIGH PERFORMANCE**

Matte Finish Stainless-Steel construction

**TOTAL MOUNTING  
FLEXIBILITY**

**ANGLE BRACKET**

Provides precise  
directional heat

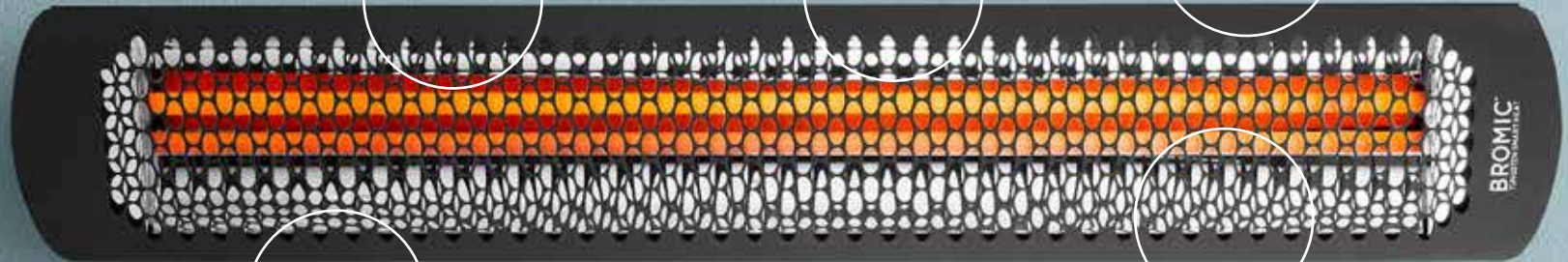

**PATENTED  
PERFORMANCE**

Superior wind resistance

**UNIQUE DESIGN**  
Honeycomb fascia facilitates  
precise heat distribution

**BROMIC.COM**

ASIA PACIFIC | NORTH AMERICA | EUROPE

Bromic pursues a policy of continuing improvement in design and performance of its products. The right is therefore reserved to vary specifications without notice.