

# ASSEMBLY INSTRUCTIONS

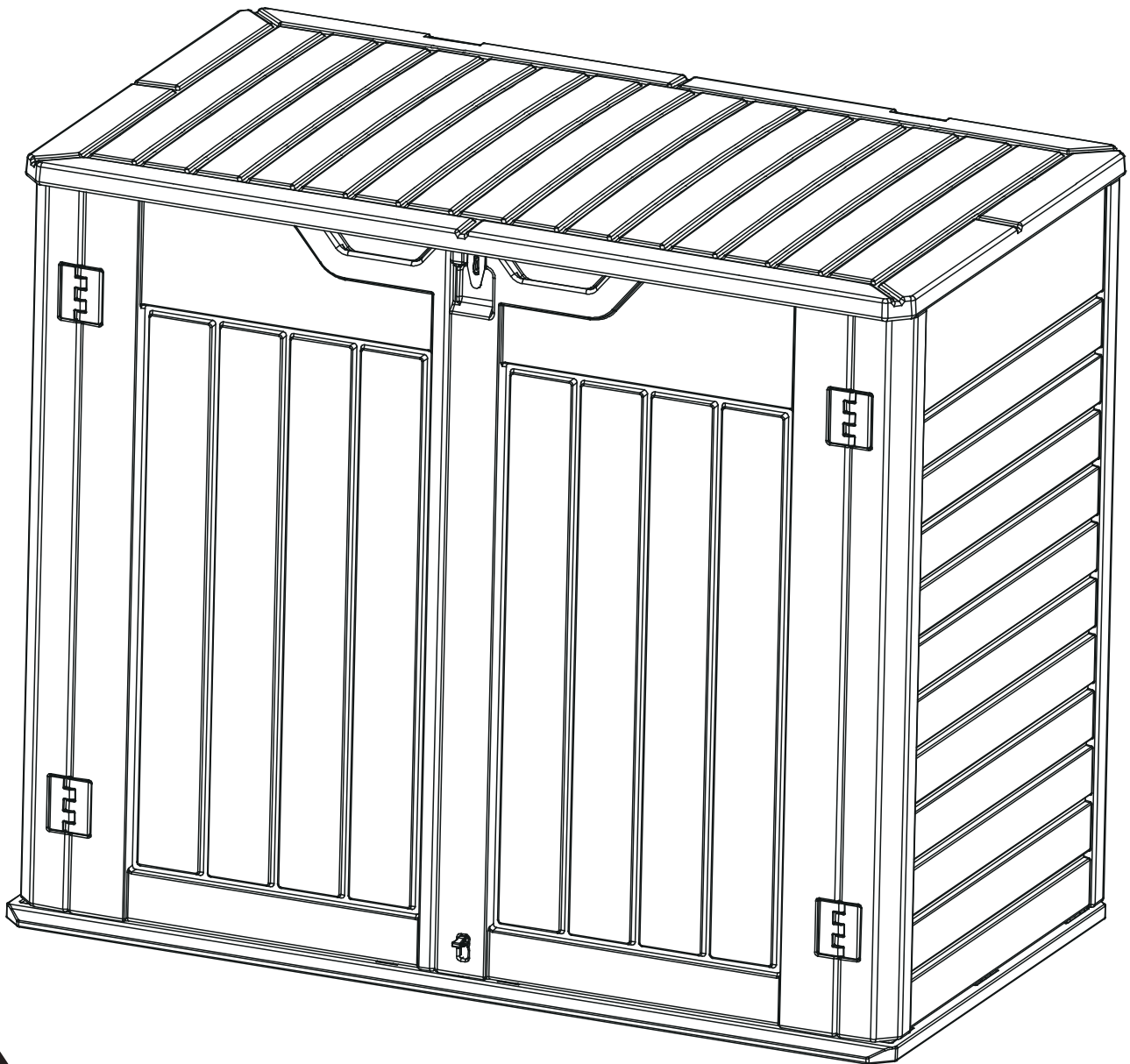



## ■ 1-Piece

Deck Box



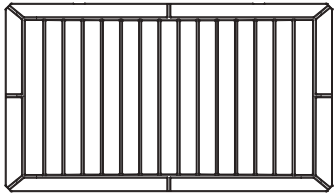

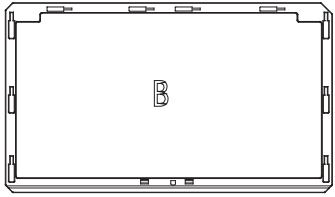
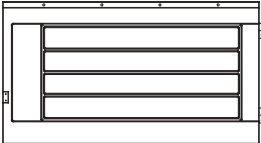
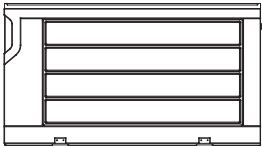
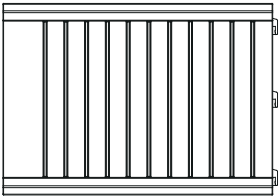

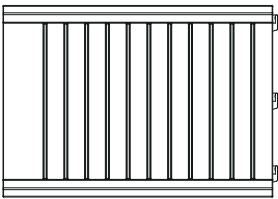
# Parts

- !** 1. Gather and organize all required parts prior to assembly.  
 2. Assemble on a flat, clean and soft surface.  
 3. Two or more people are needed for the assembly.  
 4. Align the holes before assembly and snap into place with a slight tap.  
 5. Please prepare rubber mallet in advance for convenient installation.  
 6. The product's structure prevents it from being conveniently assembled in low temperatures, so do not intentionally install at low temperatures.  
 7. During installation, please refer to the accessories guides to ensure that they are installed in the correct directions.

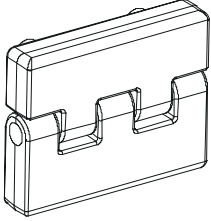
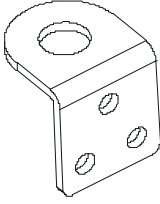
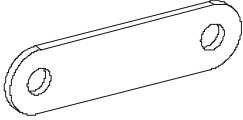
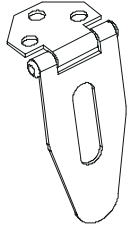
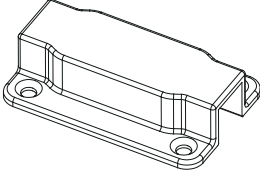
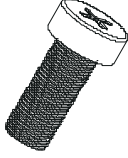
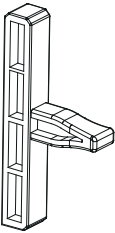
Item no.	Reference Image	Qty.	Item no.	Reference Image	Qty.
A		X1	E		X1
B		X1	F		X1
C		X1	G		X1
D		X1	H		X1

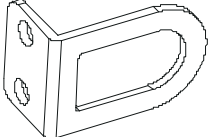
# Parts

Item no.	Reference Image	Qty.	Item no.	Reference Image	Qty.
①		X6	⑧		X1
②		X12	⑨		X1
④		X1	⑩	 M8X20mm	X18+ 1extra
⑤		X1	⑪	 M5X16mm	X24+ 4extra
⑦		X1	⑫	 M4X8mm	X12+ 2extra

# Assembly steps

## Exploded View

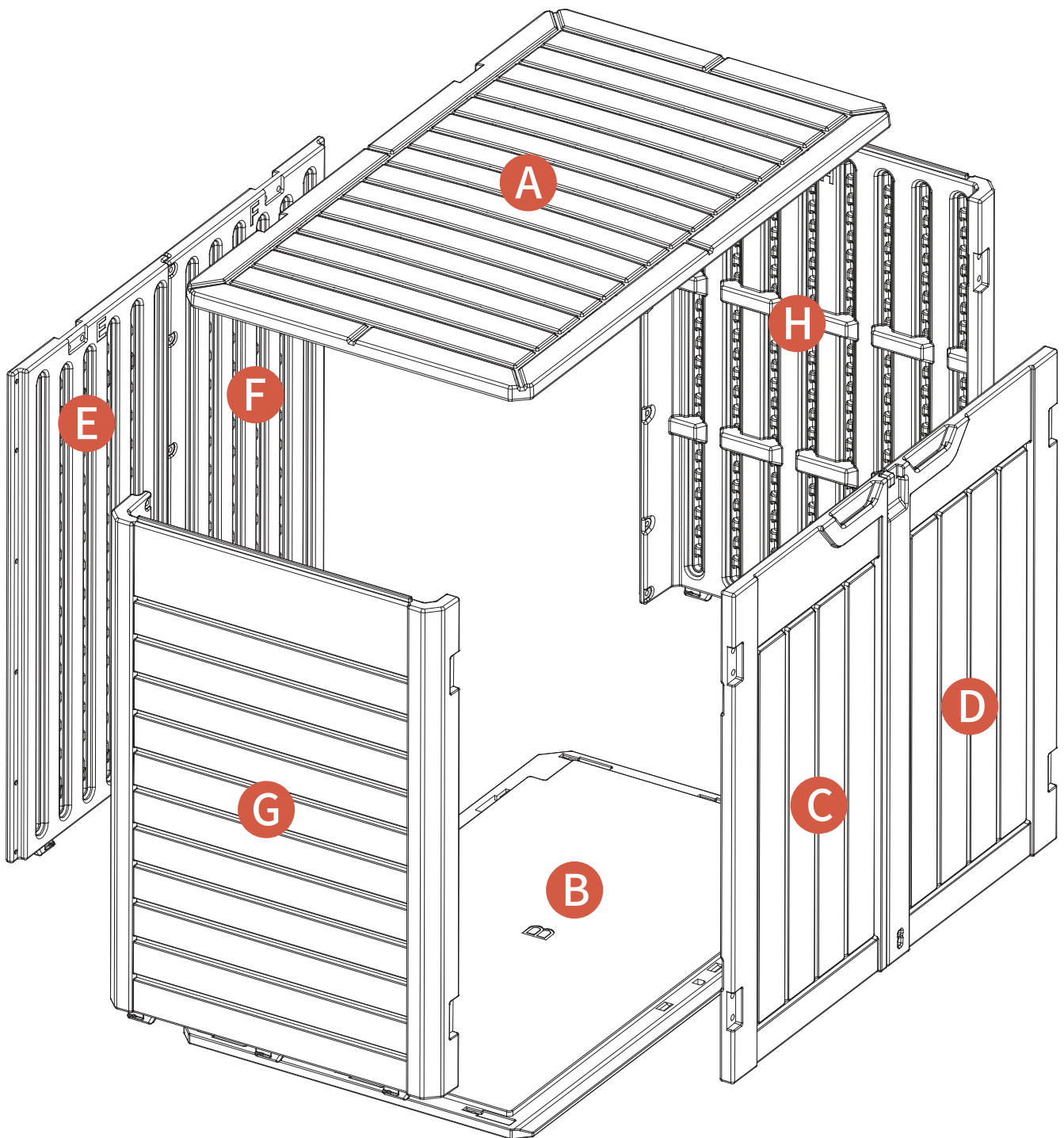

# Assembly steps

Step 1



B (X1)

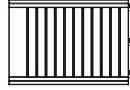

H (X1)



⑧ (X1)



⑫ (X3)

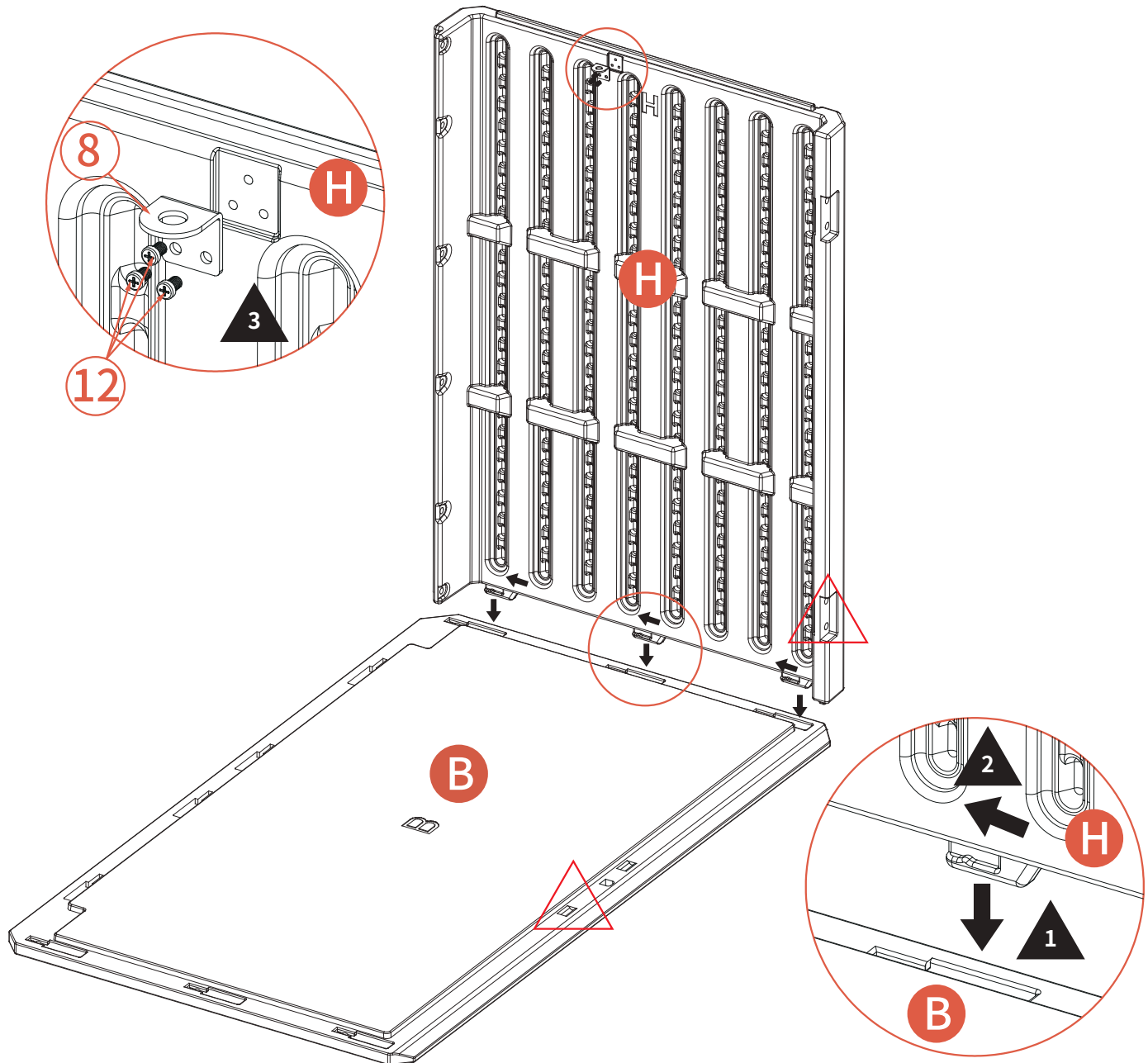

Note: The triangularly marked spots on parts B and H should be on the same side.

Insert part H into part B's slot first, then make sure it can slide backward to the full extent.

# Assembly steps

## Step 2

 F (X1)

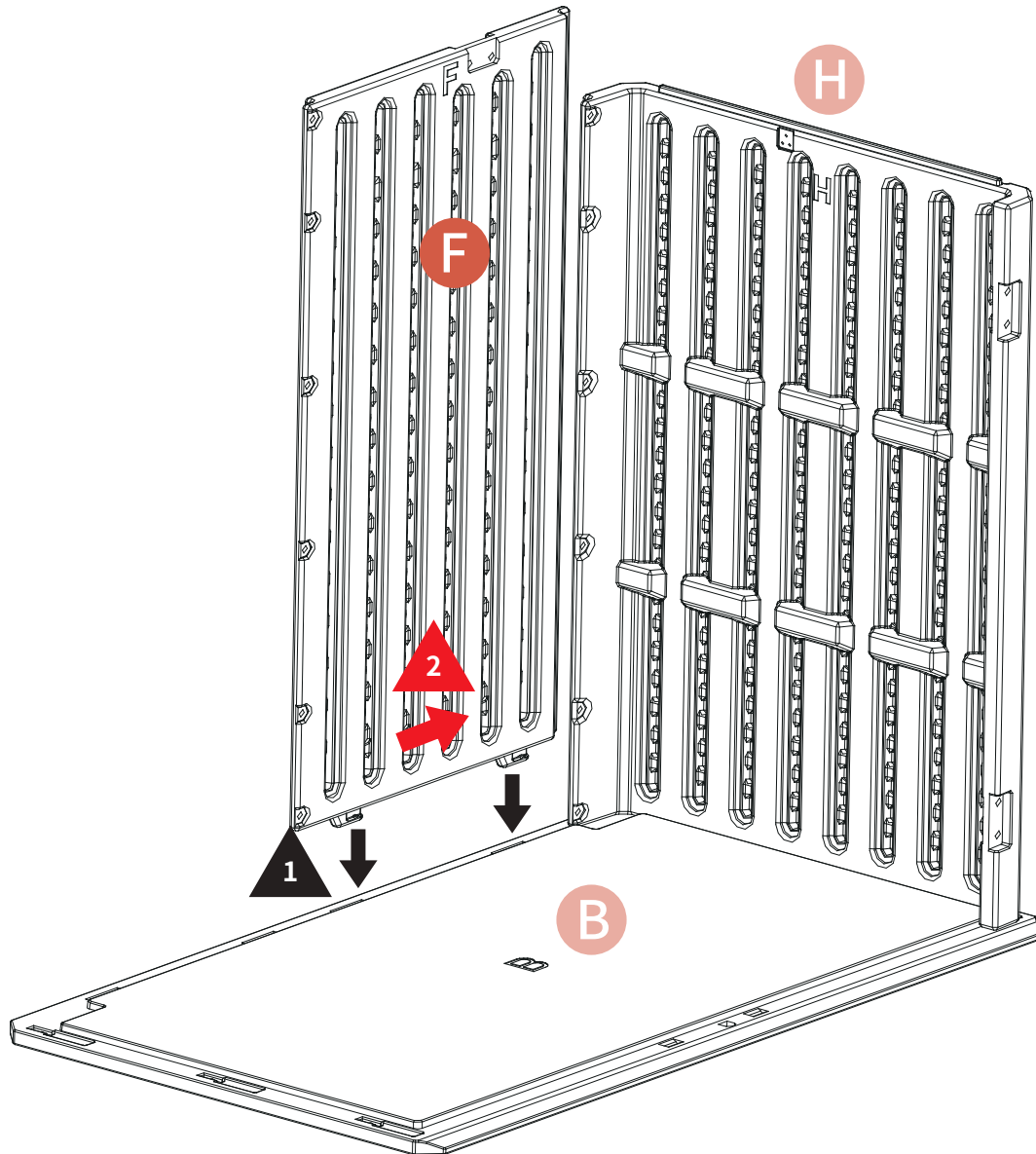

Insert parts F into part B' s slots first,  
then make sure it can slide right to the full extent.

# Assembly steps

Step 3

 E (X1)

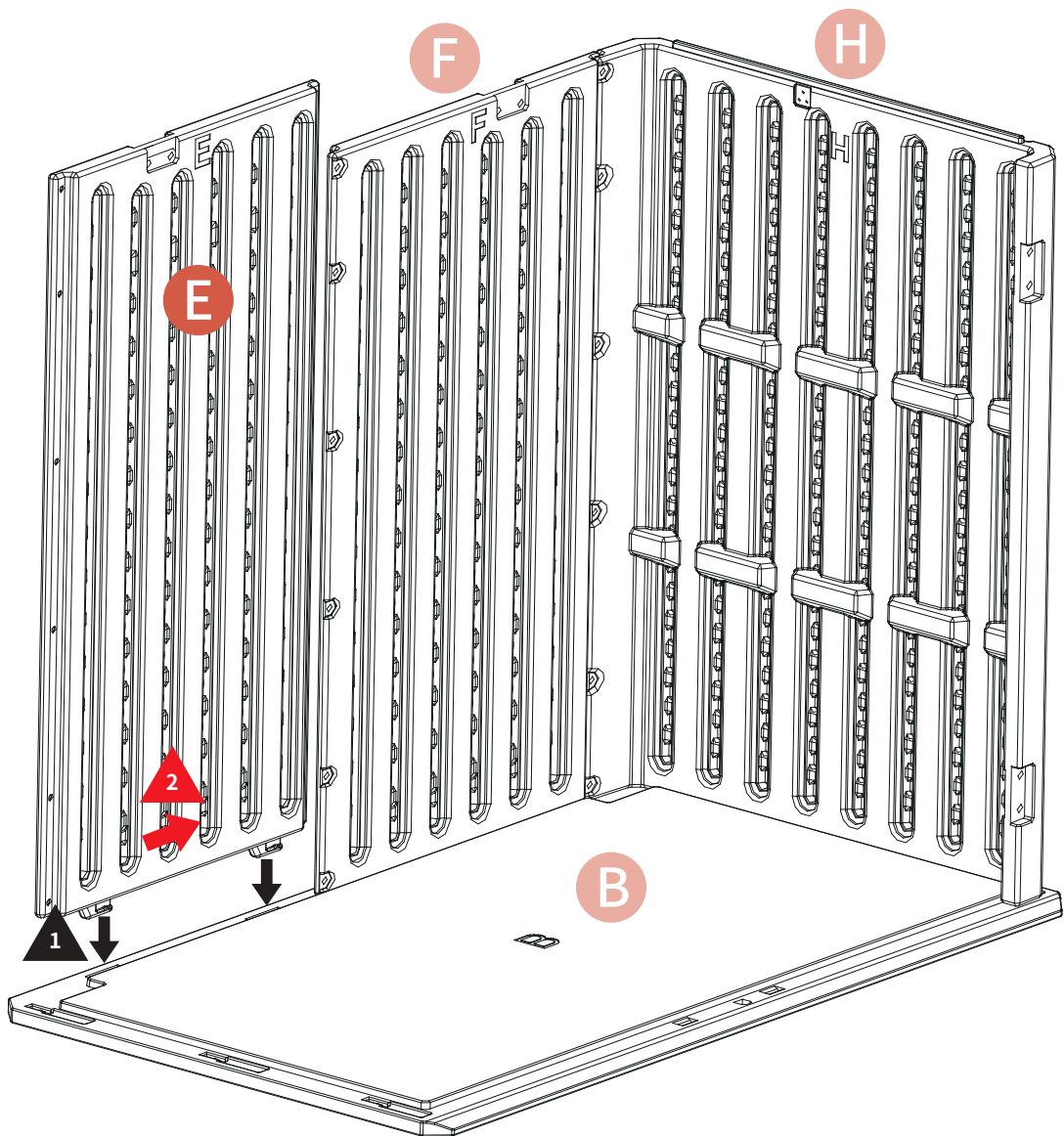

Insert parts E into part B' s slots first,  
then make sure it can slide right to the full extent.

# Assembly steps

Step 4

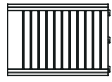

G (X1)

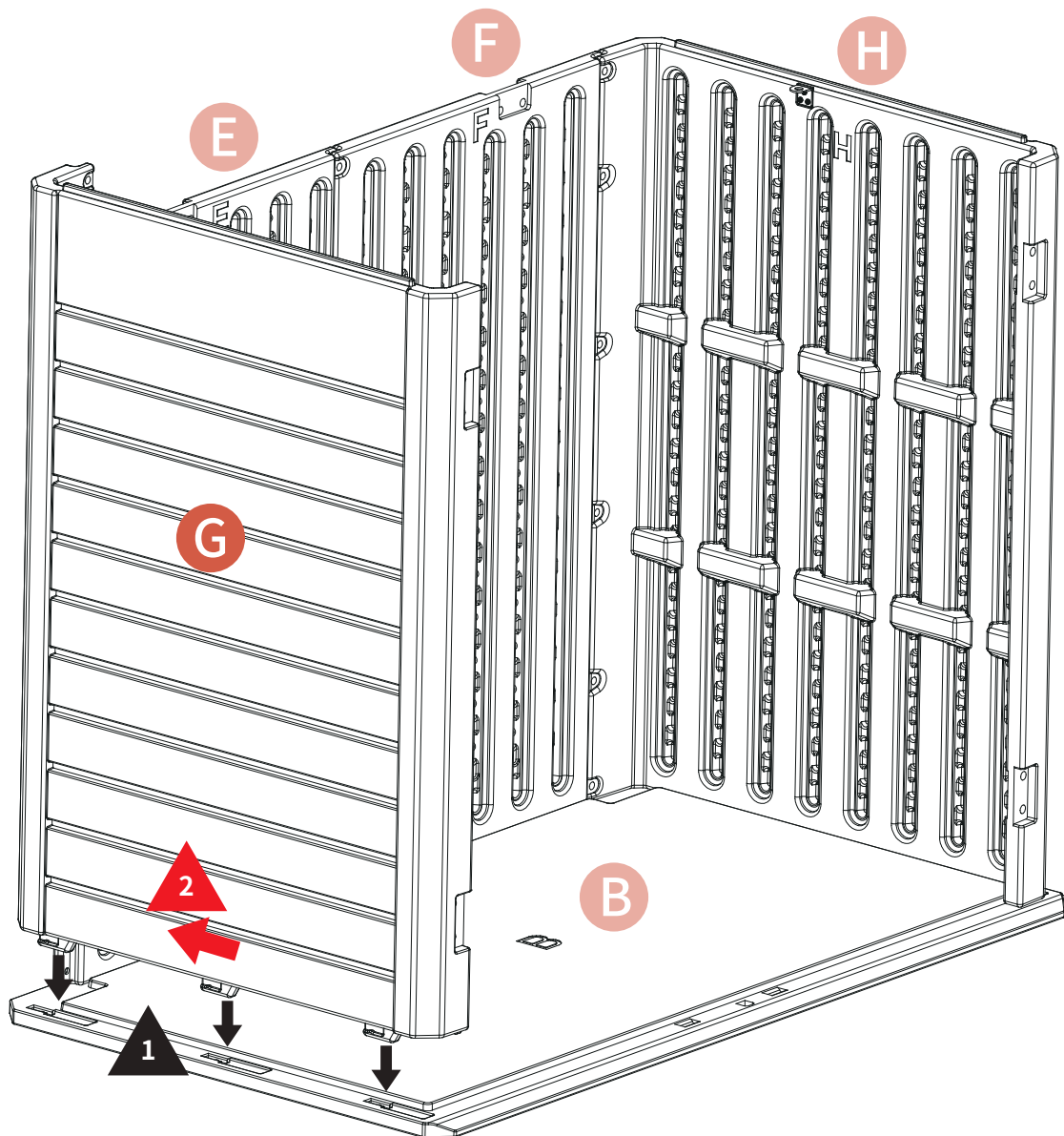

Follow the above step for parts G and B.



# Assembly steps

Step 5



⑩ (X18)

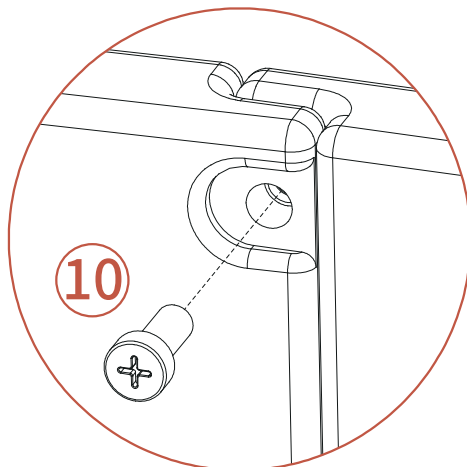
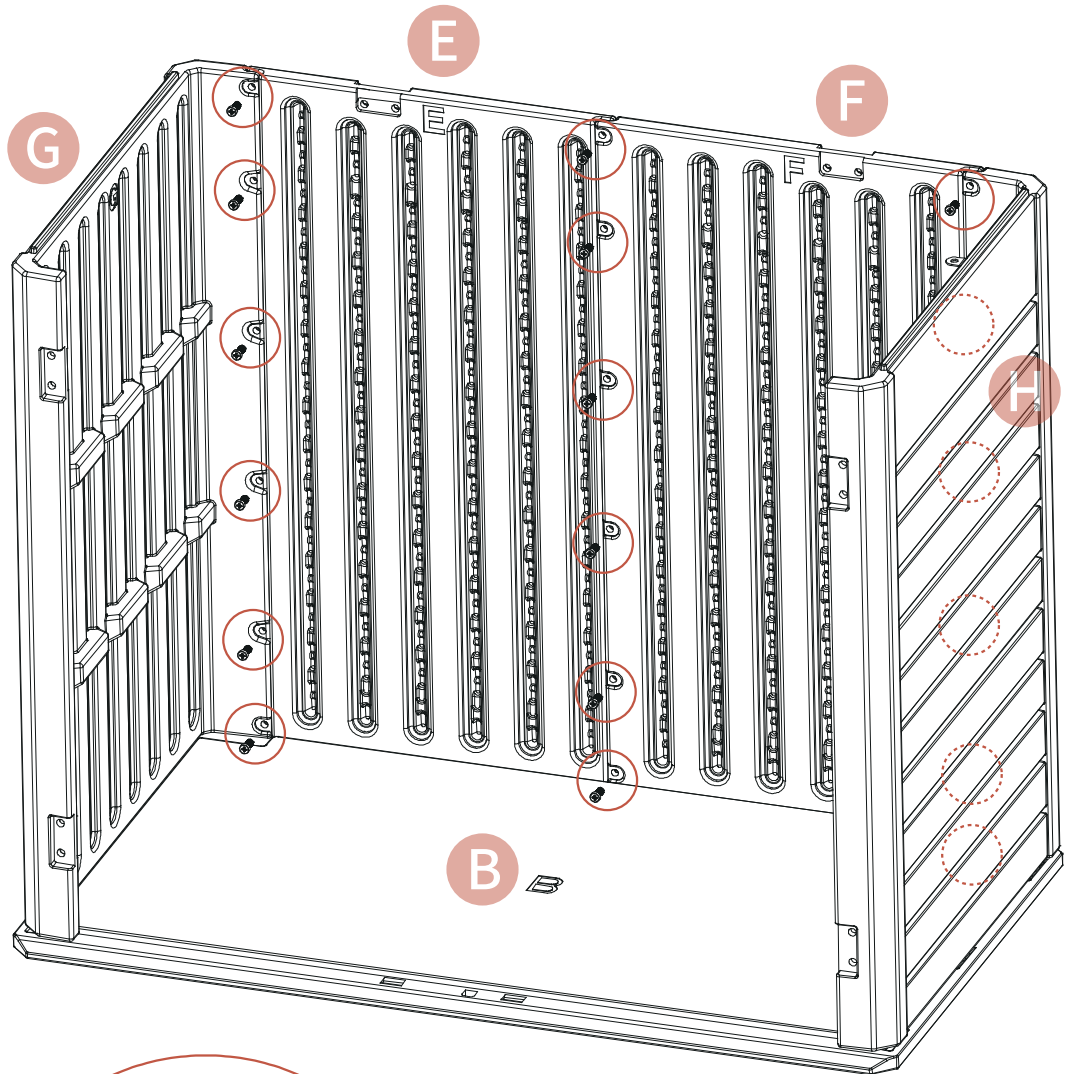

# Assembly steps

## Step 6

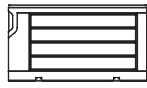

C (X1)



① (X2)

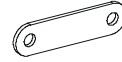

② (X2)



⑪ (X4)

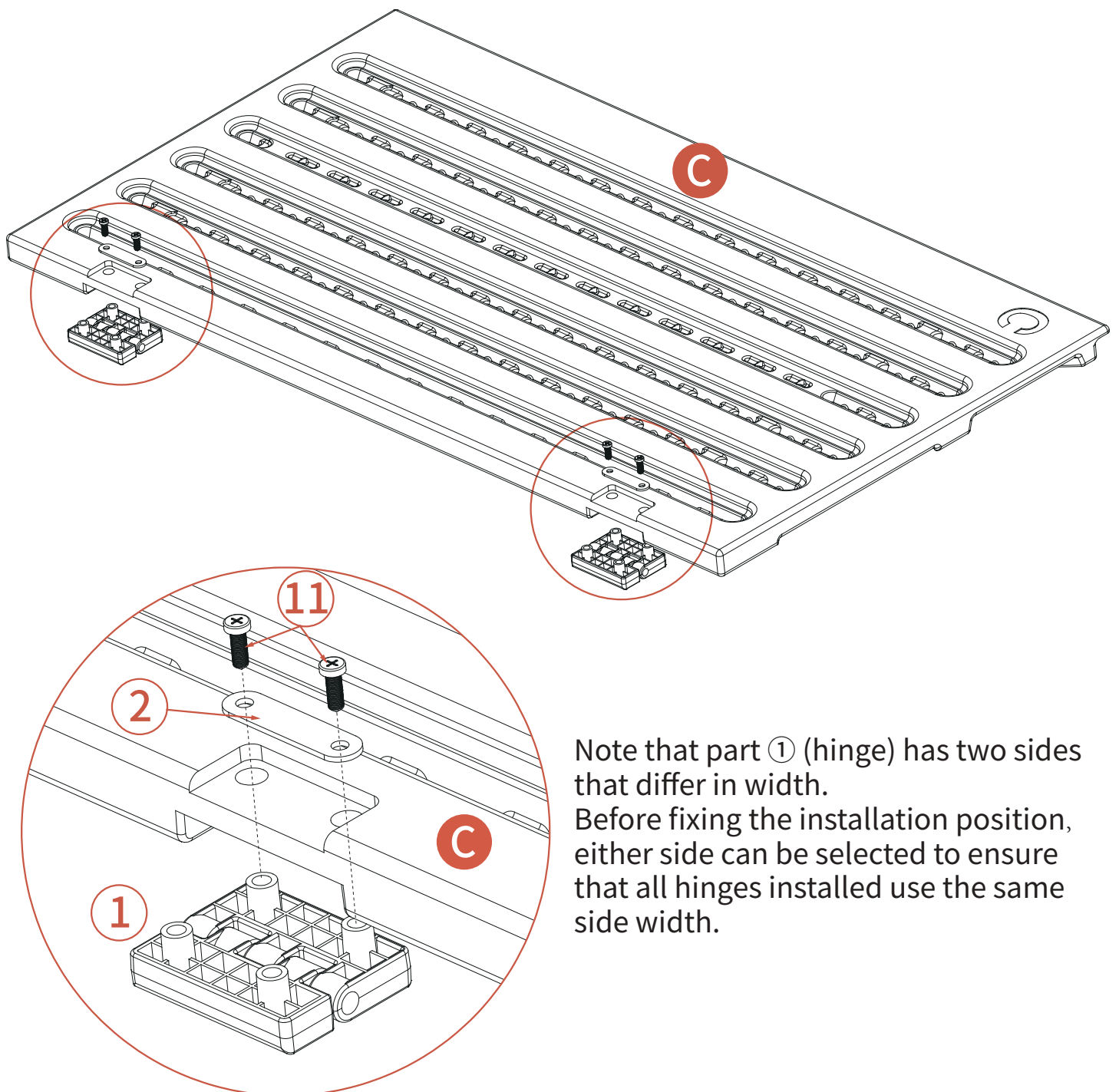

Note that part ① (hinge) has two sides that differ in width. Before fixing the installation position, either side can be selected to ensure that all hinges installed use the same side width.

# Assembly steps

## Step 7

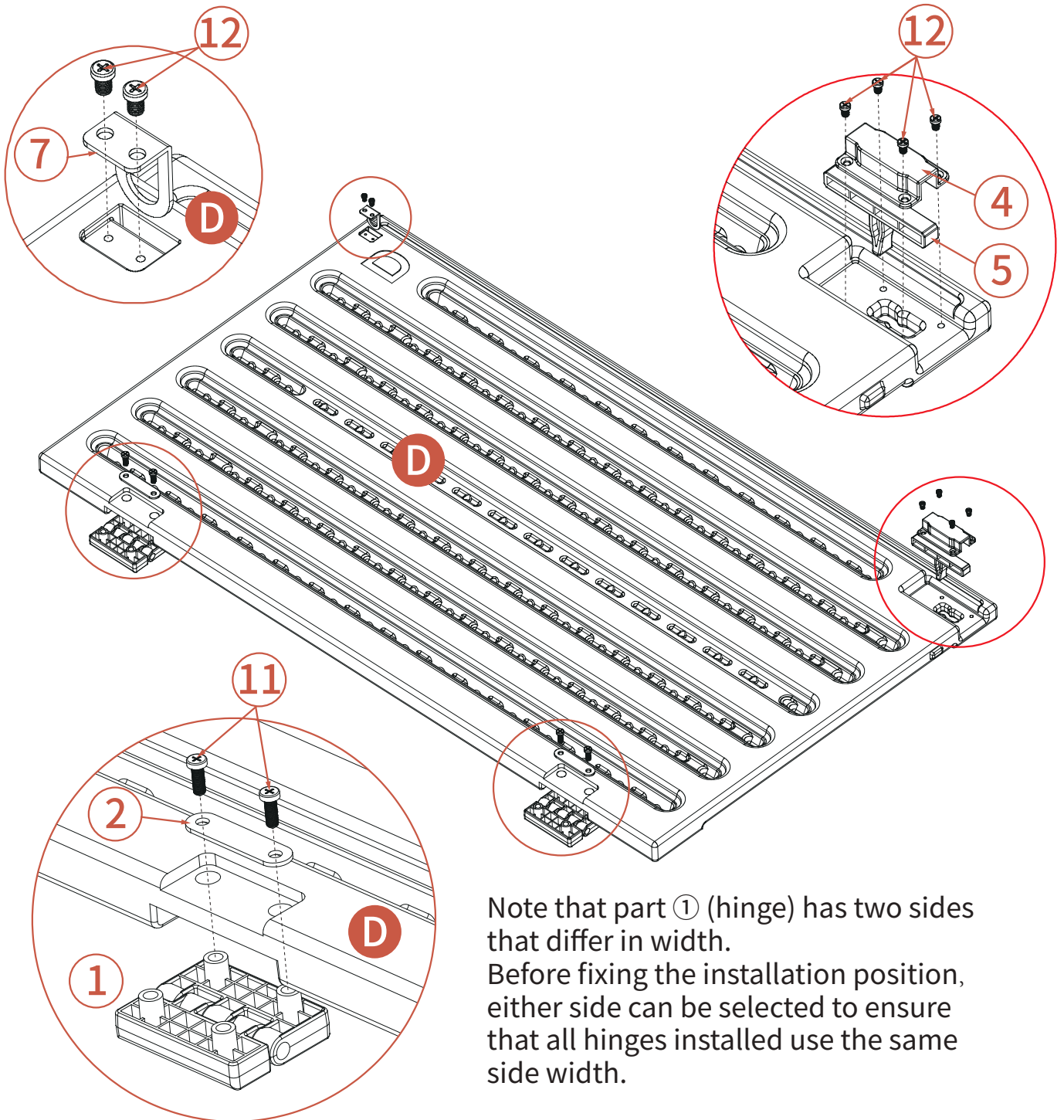
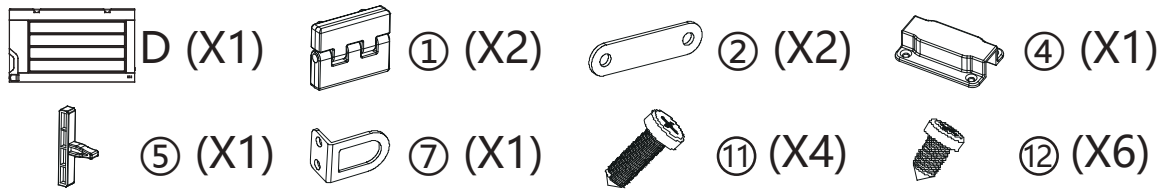

Note that part ① (hinge) has two sides that differ in width.  
 Before fixing the installation position, either side can be selected to ensure that all hinges installed use the same side width.

# Assembly steps

Step 8

② (X4)



⑪ (X8)

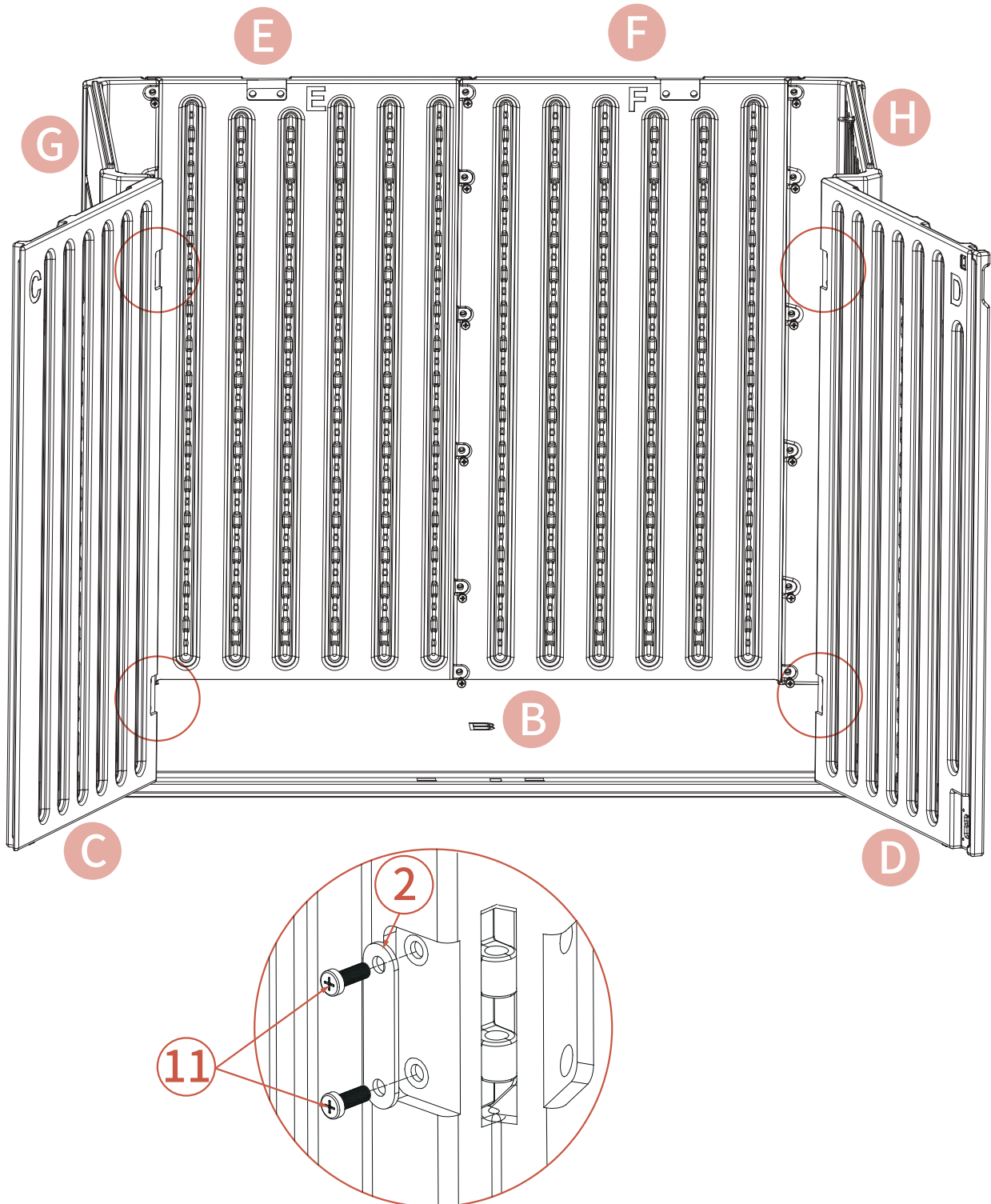

# Assembly steps

## Step 9

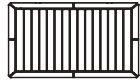

A (X1)



9 (X1)



1 (X2)



11 (X4)

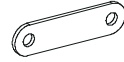

2 (X2)



12 (X3)

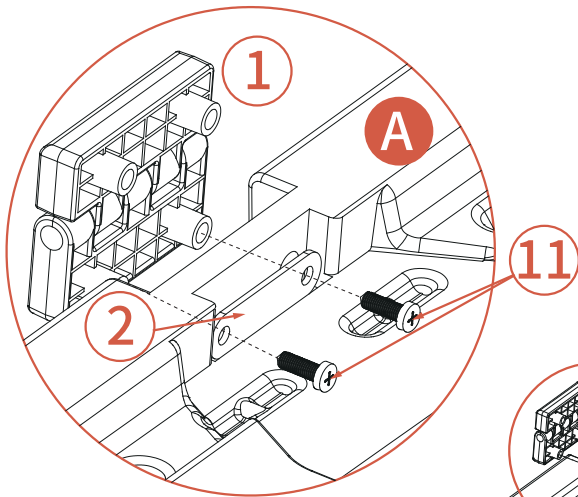

Note that part ① (hinge) has two sides that differ in width.

Before fixing the installation position, either side can be selected to ensure that all hinges installed use the same side width.

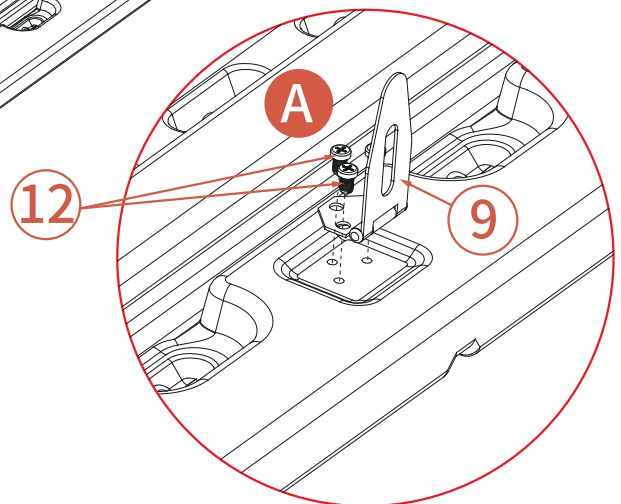
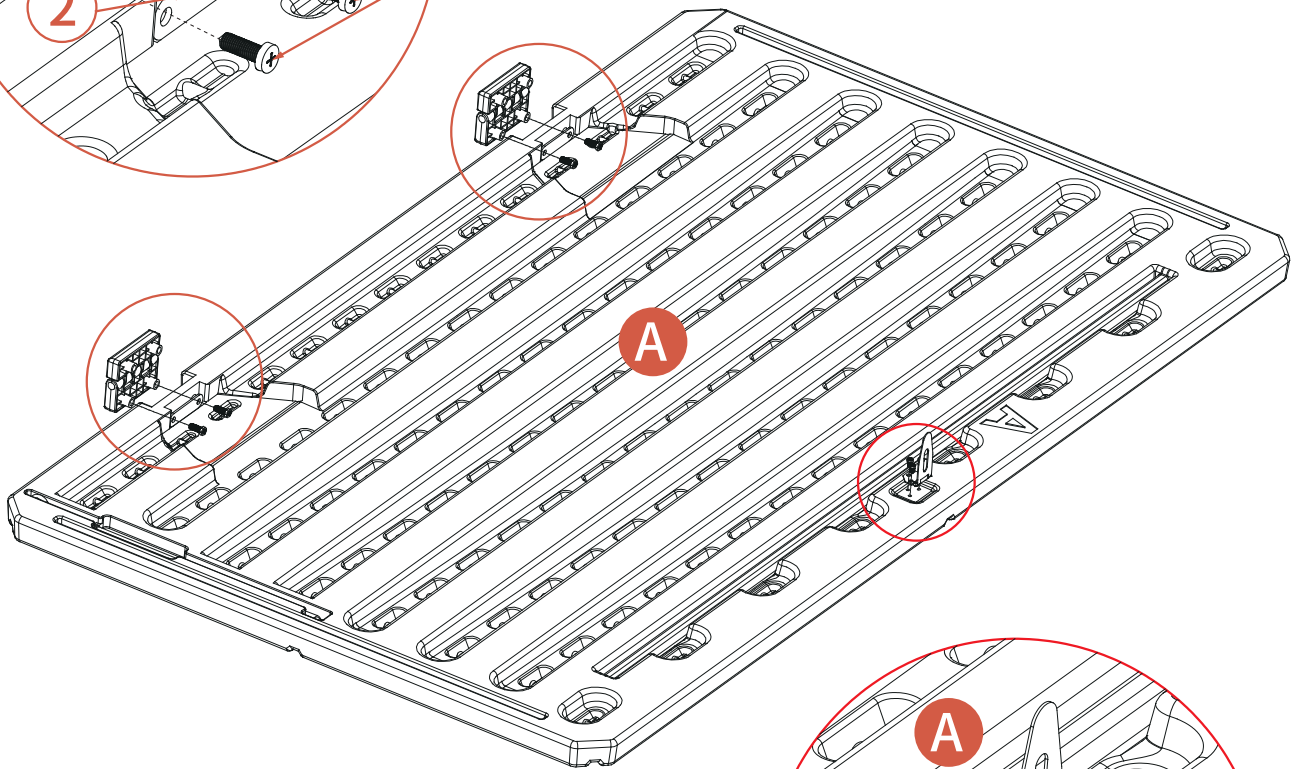

# Assembly steps

Step 10

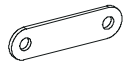

② (X2)



⑪ (X4)

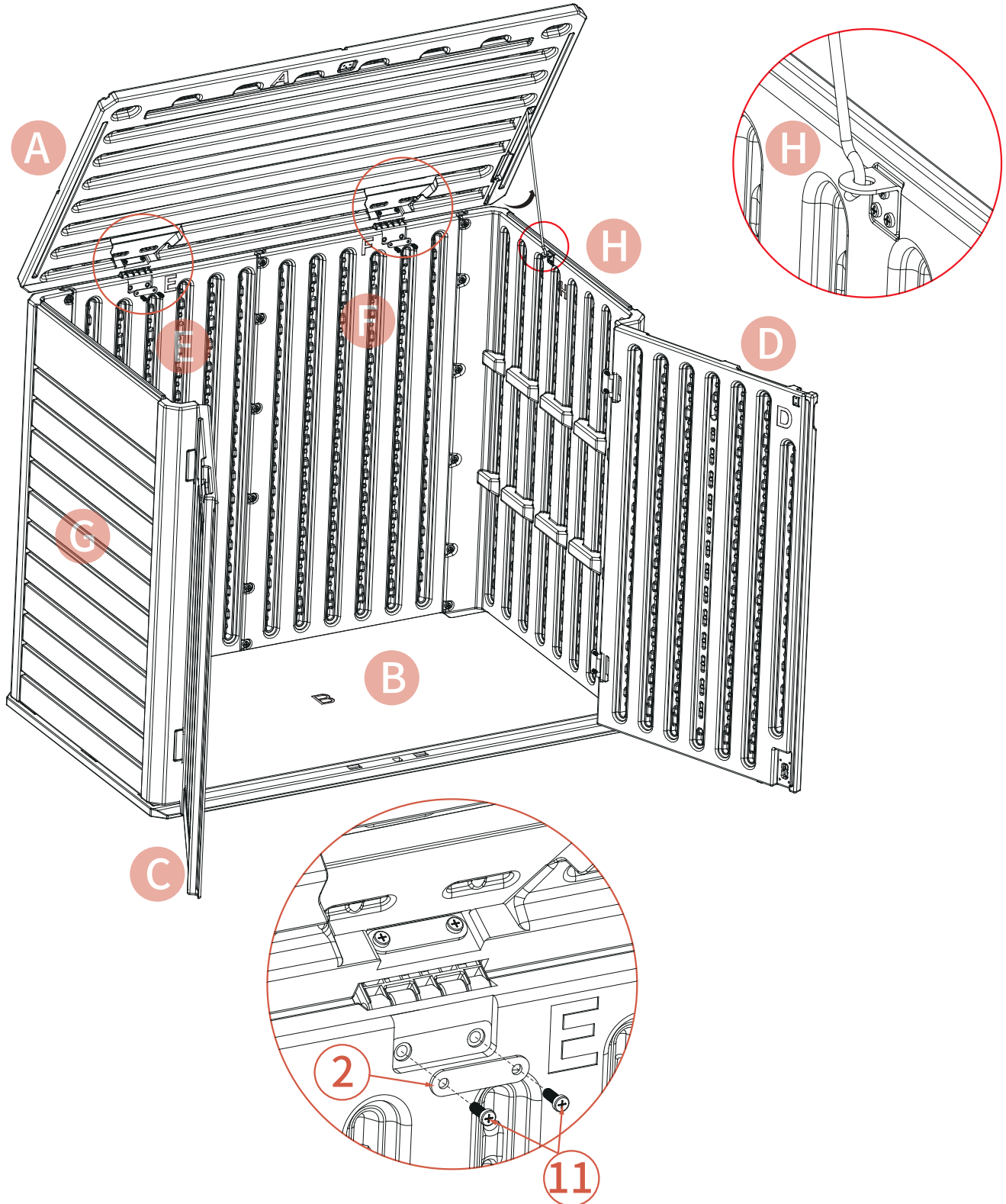

# Assembly steps

## Step 11

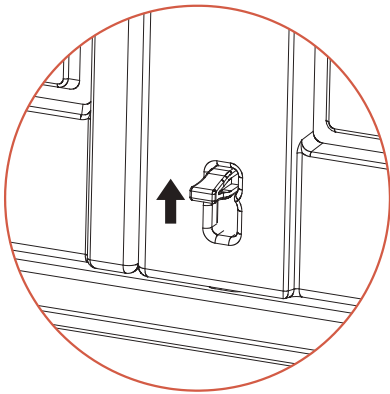
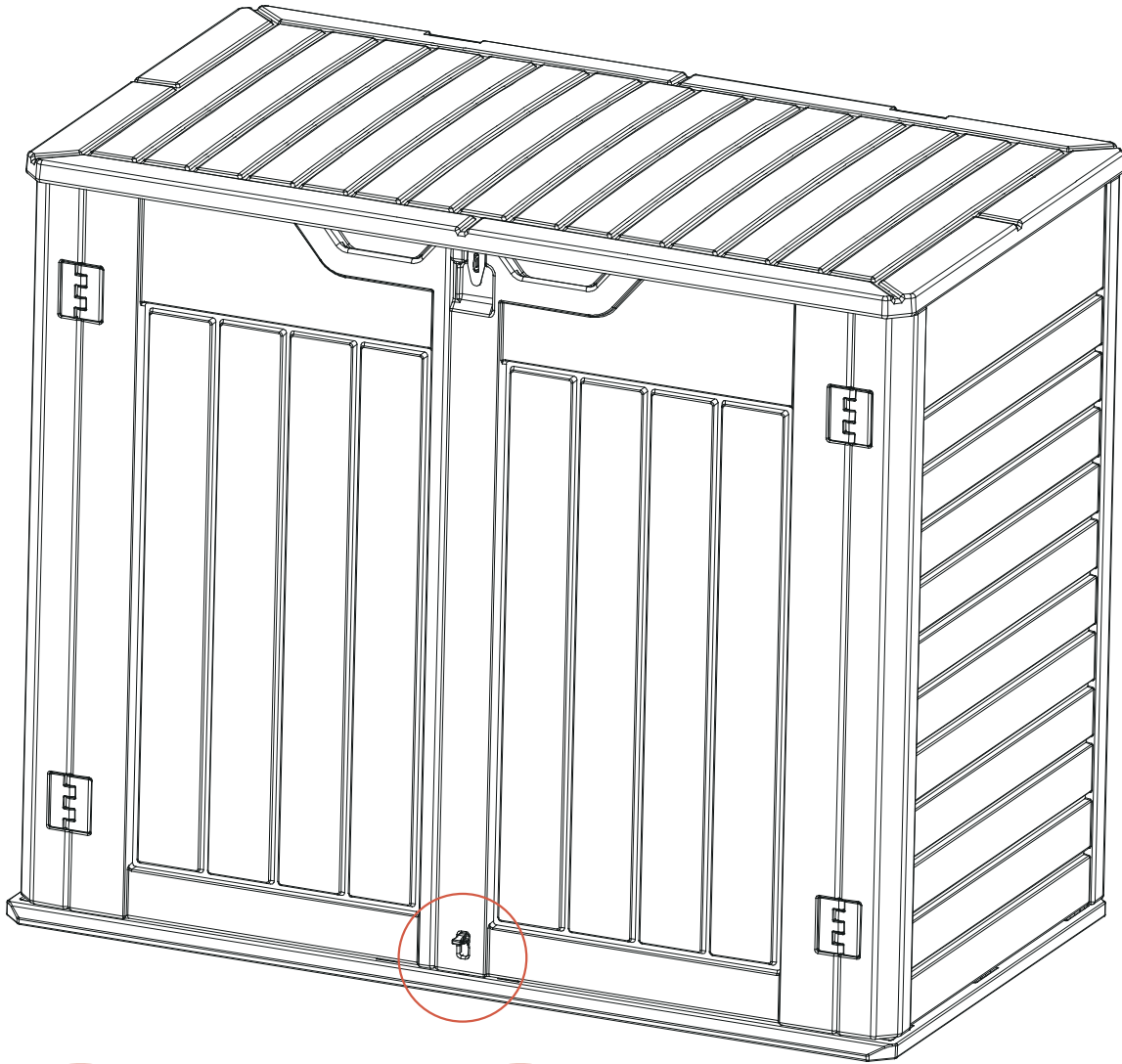

Unlocked State

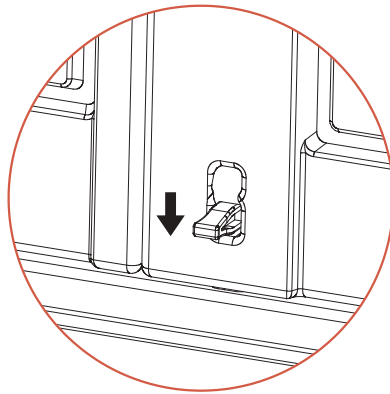

Locked State

Installation Completed