



KIVA WELLNESS
FULL SPECTRUM SAUNA
2-3 PERSON USER MANUAL



Get ready to relax, restore,
reset and rejuvenate with your new Kiva Wellness
Full Spectrum Sauna.

We are so excited for you to start your sauna
journey and experience all of the health benefits
your sauna has to offer.

Please read the user manual carefully before using,
pay special attention to the safety precautions and
keep for future reference.

KIVAWELLNESS.COM.AU

SUPPORT@KIVAWELLNESS.COM.AU | 07 4270 8000

@kivawellness   



CONTENTS

—

4

Kiva Sauna Promise

5

Safety Sheet

6

Installation Requirements

7

Parts & Features

8

Installation Process

10

Control Panel & Box

12

Trouble Shooting

13

Cleaning & Maintenance

14

Sauna Tips

15

Supercharging Your Sauna Experience

16

Warranty

Kiva Sauna Promise

ELEVATING YOUR WELLNESS & RECOVERY
THROUGH INNOVATIVE TECHNOLOGY

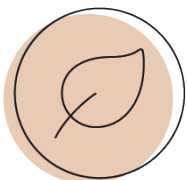

LOW EMF

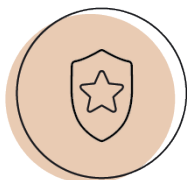

LIFETIME WARRANTY
ON HEATERS

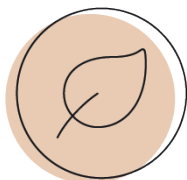

NON-TOXIC
MATERIALS



EASY TO
ASSEMBLE

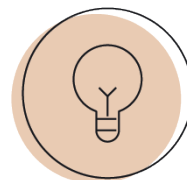

ENERGY
EFFICIENT

Safety Sheet

- The Kiva Wellness Full Spectrum Sauna is designed to be stand alone or built-in to your bathroom, pool, or spa area.
- It is recommended to install the sauna indoors for maximum protection and longevity.
- If installed outside, whether it's on a deck, veranda or in a purpose built space, it must always be completely covered and sheltered from rain, moisture, and other elements in order to protect the naturally untreated wood finish.
- Children should be supervised at all times. Children over the age of 6 years may use the sauna under adult supervision.
- The sauna should not be used if you have any open wounds, eye diseases or severe sunburn.
- Elderly, pregnant women and infants should not use the sauna.
- Exit the sauna immediately if you feel uncomfortable, dizzy, or sleepy.
- People with health conditions or diseases directly related to temperature should consult their doctor before using the Kiva Wellness Full Spectrum Sauna.
- **CAUTION:** Hyperthermia can occur when the internal temperature of your body reaches a level several degrees above normal body temperature of 37°C (98.6°F).
- The symptoms of hyperthermia include an increase in the internal temperature of the body, dizziness, lethargy, drowsiness, and fainting.
- The effects of hyperthermia include failure to perceive heat and to recognise the need to exit the room, unawareness of impending hazards, fatal damage to pregnant women, physical inability to exit the room, and unconsciousness.
- Do not use the sauna if under the influence of drugs or alcohol.
- **WARNING:** The use of alcohol, drugs, or medication is capable of greatly increasing the risk of fatal hyperthermia.
- Remove all jewellery before entering the sauna.
- To avoid fire, do not dry clothes or leave any towels in the sauna.
- While in the sauna, do not touch the light bulb. If the bulb needs to be changed, switch the sauna off and wait until the light bulb has completely cooled.
- Do not spray water on the infrared heating elements. This activity may result in electric shock or damage to the heating elements.
- Do not place pets in the sauna.
- If the sauna becomes too warm, open the vent in the ceiling or open the front door.
- After your sauna session, turn off and unplug the power cord.

Installation Requirements

3 Person Full Spectrum Sauna Only

- Have a certified electrician install a dedicated outlet for the sauna. Failure to do so will affect the operating performance of the sauna.

General

- Before connecting the sauna to a power source, please ensure all the wires, cords and connections are properly connected.
 - Plug the sauna into a proper wall power outlet. Do not share the same outlet with any other appliances.
 - Install the sauna on a completely level surface and in an area that is dry and protected from the weather.
 - **WARNING:** To reduce the risk of electrocution and burns, do not operate unless the heater guard is correctly in place.
 - **CAUTION:** Do not place combustible materials on or against heaters at any time.
 - To reduce the risk of electric shock and/or fire, do not expose the control system to water or rain. Do not open the cover to the control system as there are high tension fittings that can be dangerous. Only authorised and approved technicians should make any necessary repairs.
 - Any unauthorised repairs, alterations or modifications can lead to serious injury and can cause the sauna to operate outside its intended specification parameters which will void the warranty.
 - **WARNING:** Reduce the risk of electrocution by disconnecting the power supply before servicing.
 - Do not spray the exterior with water. If the area you are installing the sauna has a tendency for dampness, place rubber matting or other suitable barriers underneath the sauna.
 - Keep all liquids away from the heating panels and electronics.
 - Keep flammable objects and corrosive chemical substances away from the sauna.
 - To prevent burns or electrical shock, do not touch or use metal tools on the infrared heating elements or the net cover of the far-infrared heating elements.
-

Parts & Features

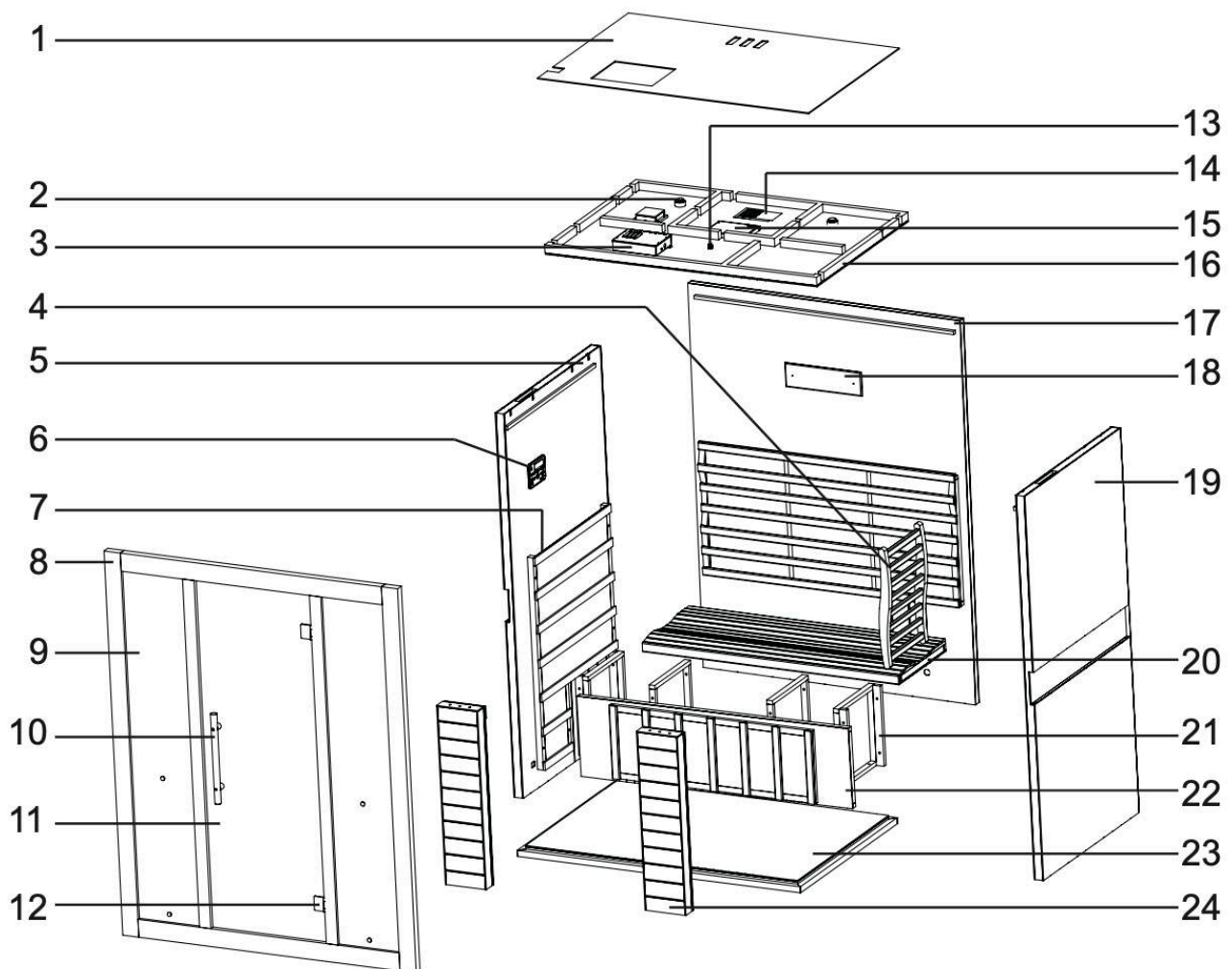

1 - Top Cover that keeps dust etc off way from Ventilation and Control Panels

2 - Speaker

3 - Control Box

4 - S Backrest

5 - Left Panel (Left Wall)

6 - Inside Control Panel for Operation

7 - Heating Panels

8 - Front Panel (Contains Glass)

9 - Glass Window

10 - Handle for Front Panel

11 - Glass Door

12 - Door Hinge

13 - Temperature Sensor

14 - Ventilation Door

15 - Color Light

16 - Top Panel (Roof)

17 - Back Panel

18 - LOGO Panel

19 - Right Panel (Right Wall)

20 - Inside Bench (For Sitting)

21 - Bench Front Board

22 - Bench Support

23 - Bottom Board (Base of Unit)

24 - Front Panel Heater

*The structure may vary from different models

Installation Process

This process is easiest with at least 2 adults working together.

Structural Creation

1. Start with the bottom panel. Place it in your desired location and ensure the front part of the panel is placed in the correct direction.
2. Assemble the back panel by aligning the back panel with the corresponding battens on the bottom panel making sure they are in the same line. One person should hold the back panel while the other person continues to the next step.
3. Align the left panel with the bottom panel and the corresponding battens. There are 3 male buckles attached to the side of the back panel. Align these with the female attachments on the left panel and ensure all 3 are tightly secured locking the left and back panels together.
4. Repeat the last action with the right panel. If done correctly the 3 sides will form a solid bond.
5. Repeat action 3 with the front glass panel. Do not cut the tie in the door until the glass panel is securely in place. Then you can cut the safety ribbon.
6. Now assemble the seat. Start with the heating panel that sits upright, sliding this into place using the exposed screws in each side wall as a guide, if done correctly this panel should stand alone without the need to hold it. Then assemble the seating supports into place before sliding the seat on top of them. Your seat should be firm and not be unstable when sitting.
7. Now you can connect your door handle. Using a larger Phillips head screwdriver, ensure that the wooden handle is on the inside.
8. Attach your heating panels on the inside of the fixed front glass. You will find 2 holes ready for you to attach your heaters in place. Once attached these are plugged in, inside your sauna.
9. Remove the dust cover from the ceiling component to expose the wires underneath, then slide on your ceiling into place and match up each wire fitting with its correctly labelled partner. ie Plug A from the control box matches up with Plug A from the Sauna Wall. Then reattach Dust cover.
10. If done correctly you will be able to switch on your sauna once it is plugged in.

Electrical Connection

1. Put any wires from the front and back panels back into the centre of the sauna cabinet to avoid pressing them when installing the internal top panel.
2. Connect all the wires and connectors to the corresponding outlets on the internal top panel. Make sure connections are tight and secure.
3. The last step is to secure the external top panel over the internal top panel. Align the top panel and secure it with the screws supplied.
4. Installation should now be complete. Plug in the power and turn the sauna on at the control panel.

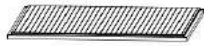

Bottom Board



Back Panel

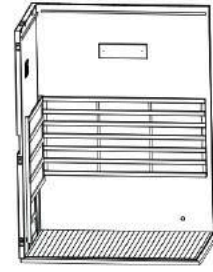

Left Panel

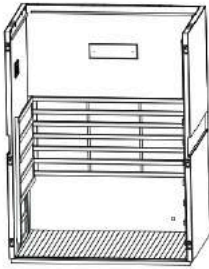

Right Panel



Bench Front Board
Bench Support



Inside Bench

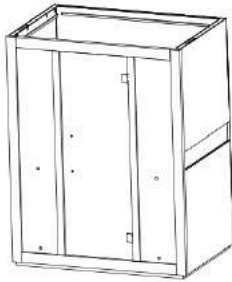

Front Panel



Top Panel
Top Cover
Handle

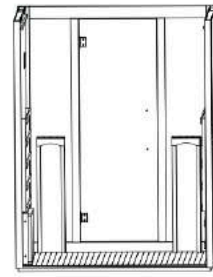

Front Panel Heater

ELECTRICAL CONNECTION (DO LAST)

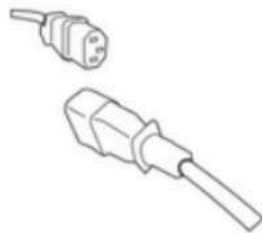

Connection cable

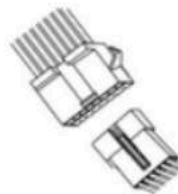

Connection plug

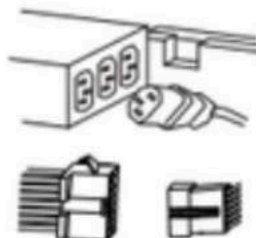

Control Panel

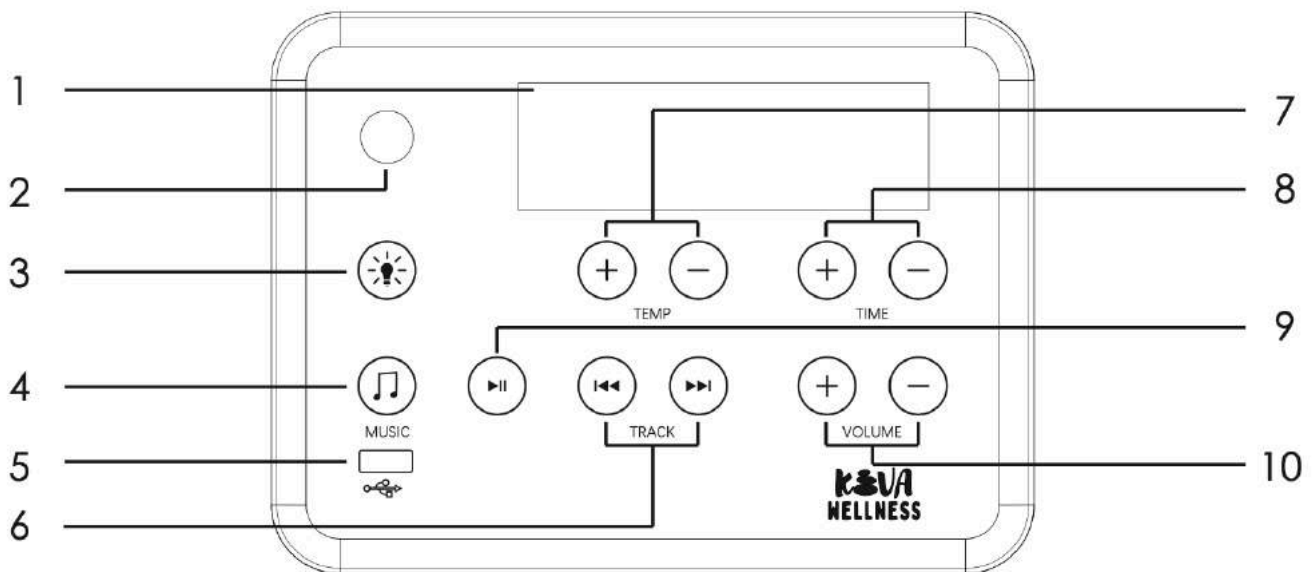

1 Display screen - For temperature, time, FM.

2 Power button - Touch this key to turn it on or off.

3 Light button - Touch the key to turn on/off the light inside of cabin.

4 Music button - Touch this key to adjust bluetooth, MP3 and FM.FM from 85.7-108.0M.

5 USB function - Touch this key to start USB function.

6 Song selection function - Press key upon the TRACK for last song and key for next one.

7 Temp control - Touch the '+' and '-' button to increase or decrease the temperature. If the 'heat' light is on, the temperature setting will increase one degree every time the '+' button is pushed. If pressed for three seconds, the setting will increase quickly. Decrease the temperature in the same manner by pressing the '-' button. After the sauna reaches the desired temperature, the 'heat' light turns off. The Fahrenheit and Centigrade display can be switched: press the temperature button "+" and "-" at the meantime.

8 Time control - Touch the '+' and '-' buttons to set the timer from 5 to 90 minutes. If pressed for three seconds, the timer will increase quickly. To extend the sauna session, reset the timer again.

9 Pause/Play - When playing music in this mode, this key is for pause or play. In FM mode, press long for 5 seconds to enter FM station search automatic.

10 Volume control - Press '+' and '-' to increase or decrease volume.

Colour Light Function

5 seconds press on "LIGHT" button, shows "2N" on display. Short press "LIGHT" button to change color of LED light.

Press to convert one color at a time and it can be cycled and memorized (L0 shade, L1 all bright, L2-17 corresponding to different colors). Quick press on TEMP+, can control LED 1 ON/OFF (if available).

Quick press on TEMP-, can control LED 2 ON/OFF (if available). Quick press on TIME+, can control RGB Light ON/OFF (if available).

Control Box

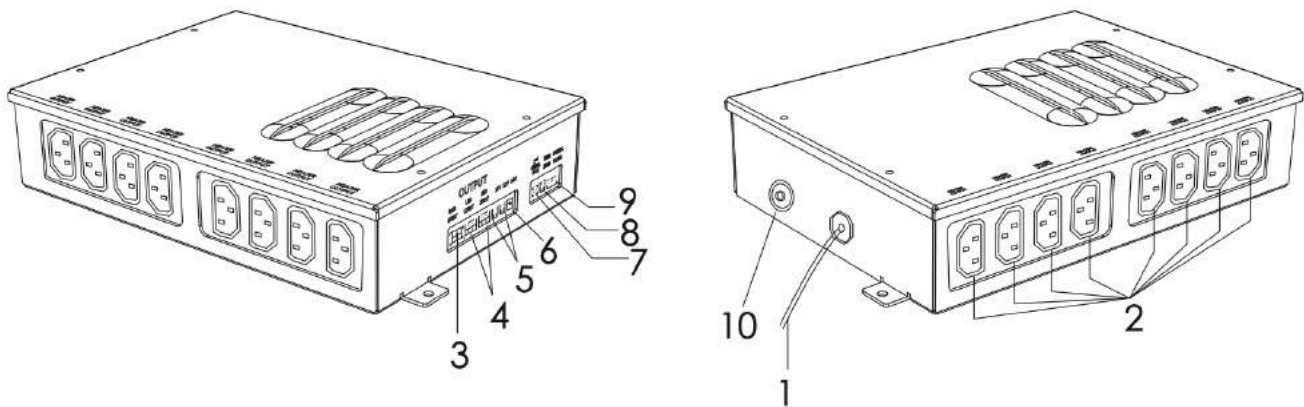

This control box is the control center of sauna room, it is installed on the top board, input/output connections as below.

- | | |
|---|--|
| 1 Main power of sauna room | 6 24V output |
| 2 Heaters power output cable (HT1--HT8) | 7 If necessary can connect another power box |
| 3 Reading lamp power output cable | 8 Temperature sensor connection port |
| 4 Color lamp power output cable(optional) | 9 Control panel connecting |
| 5 12V output | 10 Fuse reset |

Trouble Shooting:

PROBLEM	POTENTIAL REASON	NEXT STEPS
Light bulb is not working	<ul style="list-style-type: none"> • Light bulb is burned out • Light bulb wiring is loose • Problems with electrical control panel 	<ul style="list-style-type: none"> • Replace the light bulb • Replace the lamp holder • Repair or replace it
Sauna won't power up	<ul style="list-style-type: none"> • Power cord is unplugged • Outlet has no power • Power supply or circuit panel is broken 	<ul style="list-style-type: none"> • Plug back power cord to outlet • Check outlet or circuit breaker • Replace the power supply or related circuit board
Music Player doesn't work	<ul style="list-style-type: none"> • Power connector is loose or damaged • DC power supply not connected to the music player • Music player is defective 	<ul style="list-style-type: none"> • Check connector or replace it • Check DC power supply wiring or replace the power supply • Replace the music player
Speaker does not work	<ul style="list-style-type: none"> • The speaker is broken • The speaker wire is loose • The power indicator light for music player is off 	<ul style="list-style-type: none"> • Replace with a new one of the same specifications • Reconnect the speaker wire. Turn on the switch.
The temperature display shows "Er1"	NTC open circuit, wire is not well connected	Check and re-connect
The temperature display shows "Er2"	NTC open circuit	Change Thermostat
The temperature display shows "Er3"	Under -15°	Can't function under too low temperature
The temperature display shows "Er4"	Thermostat breakdown	Change Thermostat



Cleaning & Maintenance

- Always follow the instruction manual when using your Kiva Wellness Full Spectrum Sauna so that it is maintained in the best possible shape and you can enjoy longevity of your investment.
- To maintain the appearance of wood, place a towel on the sauna bench to prevent sweat from dripping onto wooden surfaces.
- After use, open the door of your sauna. This process will release moisture and help to keep the wooden surfaces dry.
- Avoid using sharp objects inside the sauna to prevent damage to internal fixtures and surfaces.
- Use soft paper or a microfibre cloth to clean the glass door.
- Do not use liquid or aerosol cleaning products inside the sauna.
- Unplug the sauna from the power outlet on the wall before cleaning. Do not use alcohol or strong cleaning chemicals to clean the sauna. NOTE: Use of chemicals will damage the wood and any natural protection layer inherent in the wood.
- Do not store the sauna in damp environments as this can cause the wood to stain and rot.

Sauna Tips

Pre sauna hydration is much more important than drinking water throughout your session. Make sure to drink plenty of water prior to commencing your sauna session. This will ensure your body is adequately hydrated and able to perspire safely.

Make sure to rehydrate after your sauna session to help reduce heat stress. It is recommended to drink plenty of fluids 2-3 hours post sauna session.

To maximise hydration pre and post sauna, try out this delicious fruity infused coconut water recipe.

FRUITY INFUSED COCONUT WATER

All you need:

- 2 cups coconut water
- 2 cups water
- 2 cups fruit of choice (fresh or frozen)

Method:

1. Fill a large jug with coconut water and filtered water
2. Add fruit slices to the jug and stir
3. Place jug in the fridge for at least 30 minutes to chill and infuse
4. Serve in glasses over ice



Supercharge Your Sauna Experience

WITH THESE SELF CARE RITUALS



Light stretching: helps to loosen tight muscles and increase flexibility



Hydration: sip and celebrate your sauna experience with a fresh juice, filtered water or chilled coconut water



Massage: use your favourite massage tool or hands to lightly rub muscles to relieve tension



Deep breathing/meditation: releases tension, promotes relaxation and a sense of calmness



Dry brushing: helps to detoxify the body, deeply exfoliate and leaves skin feeling smooth and fresh



Read: take this time to unwind and get lost in a good book



Podcasts / playlist: use the bluetooth function on the sauna control panel to take your listening experience to the next level. This is the perfect way to catch up on your favourite podcast or unwind with your favourite music playlist.



Hair mask: helps to prioritise self care and give your hair some TLC

Warranty

Warranty Period: lifetime warranty on carbon heaters and 5 year general.

Kiva Wellness are the warranty providers for Kiva Wellness products. Kiva Wellness warranty this product to be free from defects in materials and workmanship while in normal domestic use for a period of one year on parts and labour (with the exception of a life warranty on the carbon heaters) from the original date of purchase.

Do not return your sauna to the store you purchased from before contacting Kiva Wellness directly.

LOGGING A WARRANTY CLAIM

Should you experience any issues with your product, please follow the below steps to lodge a warranty claim:

1. Contact Kiva Wellness and let them know the following details:
 - Your warranty details including name, email and phone number
 - Product name and model number
 - Product serial number, found on the rating label of the product
 - Explanation of how the damage occurred
 - Photos of the damage or issue is highly beneficial to expediting your claim
2. Kiva Wellness will assess your claim and respond within 24-48 hours. If the product exhibits a defect while in normal domestic use and within the warranty period; Kiva Wellness will either repair or replace the product or defective part free of charge.
3. In the event that the product is required to be sent to the service centre, the customer is required to pay for all packing, freight and insurance costs for transit of the product to Kiva Wellness. This is subject to the applicable consumer laws in your jurisdiction.
4. If the product, or one of its parts, qualifies for replacement or service within the 30-day period after the date of purchase, Kiva Wellness will arrange the shipping at no cost to you.
5. Any product sent to Kiva Wellness must include a return authorisation form that will be provided to you after your warranty claim is accepted. Failure to include this form may result in the product being rejected from the warehouse or a delayed service time.
6. In the event that the warranty period for a product has expired, or if a product does not qualify for warranty service, repair or replacement, customers can still buy replacement parts or have products repaired by one of the Kiva Wellness service centres. Please contact Kiva Wellness for further information. Kiva Wellness will contact you with a quote prior to undertaking any service work outside of the warranty coverage.
7. Typical turn-around times to address warranty claims can be between 10-14 business days, plus shipping, depending on location and type of damage or warranty claim.
8. In no event will the liability exceed the retail value of the product. We make no warranty with respect to parts, from a source other than Kiva Wellness.

9. In the event that warranty parts or products are provided, the customer must cover the related shipping costs to receive goods.

10. All exchanged or substitute parts and products replaced under warranty service will become the property of Kiva Wellness. Repaired or replaced products or parts thereof will be warranted by Kiva Wellness for the balance of the original warranty period.

11. (Australia only) Kiva Wellness goods come with guarantees that cannot be excluded under the Australian Consumer Law. You are entitled to a replacement or refund for a major failure and compensation for any other reasonably foreseeable loss or damage. You are also entitled to have the goods repaired or replaced if the goods fail to be of acceptable quality and the failure does not amount to a major failure.

WARRANTY DOES NOT COVER

1. Damage, accidental or otherwise, to the product, not caused by a direct defect in factory workmanship or materials.

2. Damage due to abuse, mishandling, alteration, misuse, commercial service, tampering, accident, failure to follow the care, operating and handling provisions indicated in the instructions.

3. Damage caused by parts or services not authorised or performed by Kiva Wellness.

4. 'Normal' wear and tear that naturally and inevitably occurs as a result of normal use or ageing.

5. Some states do not allow the exclusion or limitation of incidental or consequential damages. Therefore, the above limitations may not apply to you in the case of damage in shipment. If your product was damaged in shipment: Immediately report this type of damage to the parcel carrier and have them file an inspection report to contact the distributor from whom you purchased the product for further instructions.

6. You have rights and benefits under the consumer laws in your jurisdiction. Without detracting from these rights or benefits, Kiva Wellness excludes all liability in respect of this product for any other loss which is not reasonably foreseeable from a failure of this product, which may include liability for negligence, loss of expenditure associated with the product and loss of enjoyment.



EMF Test Results

MEASURING DISTANCE: 30MM

TEST PROCEDURE: EN 62233:2008

FREQUENCY RANGE: 10HZ-400KHZ

TEST VOLTAGE: AC120V / 60HZ

RESULT: PASS

FRONT 1.139% (OF RECOMMENDED ALLOWABLE RADIATION LIMIT: 100%, 10MG)



REAR 1.137% (OF RECOMMENDED ALLOWABLE RADIATION LIMIT: 100%, 10MG)

KIVA WELLNESS

ELEVATE YOUR WELLNESS & RECOVERY

[KIVAWELLNESS.COM.AU](https://www.kivawellness.com.au)

07 4270 8000

@kivawellness   

Kiva Wellness products should not be considered medical devices, and should be treated as general wellness products only. Our product range has not been designed to prevent or treat medical conditions, and we recommend you consult a health practitioner if you are unsure about whether a Kiva Wellness product is suitable for you.