

# Milo

## Bassinet + Stroller Bundle

User Guide

**Second Rule of Parent Club:** always read your

# MANUAL



# Safety First

Thanks for choosing Milly and Coup.

We bet you can't wait to meet Milo but before you do, please spend 5 minutes reading through our tips to avoid tears and safety warnings on page 6 - 8.

Whilst Milo complies with the Australian & New Zealand Safety Standards, if you're not using the stroller correctly or are not aware of the safety features, serious accidents can occur.

Wishing you many fun, happy and safe adventures out and about with Milo!



## Warranty Information

Milo comes with a 3 year defects warranty to cover against faults in materials and workmanship when your stroller is used under normal conditions, according to our user manual and technical specifications.

Our goods come with guarantees that cannot be excluded under the Consumer Law in the country of purchase. You are entitled to a replacement or refund for a major failure and for compensation for any other reasonably foreseeable loss or damage. You are also entitled to have the goods repaired or replaced if the goods fail to be of acceptable quality and the failure does not amount to a major failure.

For full warranty terms and conditions or to make a claim, please visit the Warranty page of our website for details.

# Contents

- 3. Warranty information**
- 5. Parts checklist**
- 6. Safety warnings**
- 10. Setting up the Bassinet**
- 11.** Attaching + removing the Bassinet
- 12. Using the Bassinet**
- 14. Setting up your Stroller**
- 14.** Frame
- 15.** Seat
- 17.** Canopy
- 19.** Harness
- 20.** Belly bar
- 21. Using Milo**
- 21.** Brake, wheel locks
- 22.** Basket, handlebar, seat recline
- 23.** Reversing the seat
- 24.** Folding the stroller
- 26. Using your Milo with a car capsule**
- 28. Accessories**
- 29. Maintenance**
- 30. Cleaning**
- 31. Spare Parts**

# Meet Milo!

## Parts Checklist

Please check that you have all the below parts and accessories.

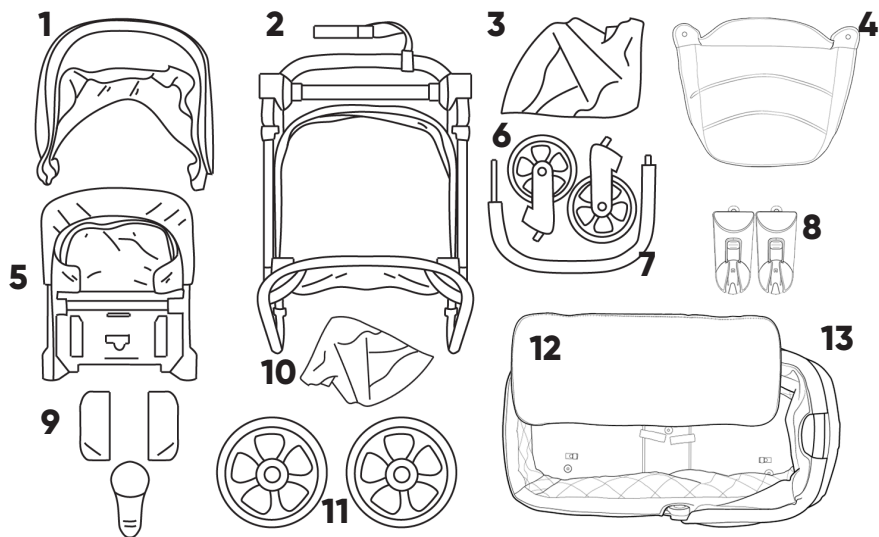

- 1** Canopy
- 2** Frame + Basket
- 3** Bassinet Rain Cover
- 4** Bassinet Cover
- 5** Seat
- 6** 2 x Front Swivel Wheels
- 7** Belly Bar
- 8** Bassinet Adaptors
- 9** Harness Covers
- 10** UV Cover
- 11** 2 x Rear Wheels
- 12** Bassinet Mattress
- 13** Bassinet

# Tips to avoid tears

## Safety Warnings

Milo is designed and tested to comply with AS/NZS2088:2013 and Consumer Protections Notice No. 8 of 2007.

Safety is a serious matter. Please read and follow the below warning notices before using your stroller. Failure to do so could result in serious injury or even death.

### **⚠ WARNING** TO AVOID INJURY OR DEATH:

- ALWAYS APPLY THE BRAKES WHENEVER THE PRAM/STROLLER IS STATIONARY.
- DO NOT LEAVE CHILDREN UNATTENDED.
- SECURE THE CHILD IN THE HARNESS AT ALL TIMES.
- DO NOT CARRY EXTRA CHILDREN OR BAGS ON THIS PRAM/STROLLER.
- MAKE SURE CHILDREN ARE CLEAR OF ANY MOVING PARTS IF YOU ADJUST THE PRAM/STROLLER.

#### **Baby (under 6 months) specific**

- Seat must be reclined to the flattest position for use with babies under 6 months of age until they can sit-up unaided and support their head. Without being able to support their head there is a risk that their head tilts forward and blocks oxygen flow.
- The harness must be used at all times with all 5 straps secured to prevent your baby falling out.
- Monitor your baby regularly when using the newborn insert.

adjusted safety harness at all times with all 5 straps secured.

- Never leave the harness buckled when not fitted to the child in the stroller. The harness can form loops which may pose a strangulation hazard.

#### **Accessories & replacement parts**

- Do not use parts or accessories that are not approved for use with the Milo range. Doing so may be unsafe and may also void your warranty. (e.g. toddler boards, bag hooks etc)

#### **Safety harness**

- Please ensure that your child correctly wears the fitted and

#### **Folding & carrying your stroller**

- To avoid finger entrapment, keep your own and your

children's fingers clear of any folding parts.

- Do not lift or carry the stroller when occupied by your child.
- Do not lift or carry the stroller when fully assembled.
- Only lift and carry after folding.
- Always remove the car capsule prior to folding and carry separately.
- Ensure that the automatic frame lock is engaged before lifting or carrying the stroller.
- Make sure the stroller and all parts are secured when being transported in a vehicle.

### **General Safety**

- This is not a toy.
- Do not allow your child to climb, stand on or play with the stroller.
- Do not use the stroller in a manner for which it is not designed.
- To avoid tipping, do not allow your child to climb unassisted into the stroller.
- Keep children clear of the stroller before making any adjustments.
- Not suitable for running, rollerblading or skating.
- Remove your child and fold the stroller when going up or down stairs or escalators.
- Take your child out of the stroller when travelling by bus, tram or train.
- Gentle sloping surfaces may be unstable. On steeper sloping and uneven surfaces, there is a possibility that the stroller may

tip over and you may need to remove your child.

- Do not use if any part is broken, torn or missing. Replacement parts are available from our website or by contacting us.
- Do not use or leave the stroller near open fire or exposed flame.
- Never leave rain covers or other covers over the stroller indoors, in a hot atmosphere or near a heat source.
- Always supervise whilst the stroller is covered.
- Always ensure that the frame and the seat/car capsule are correctly engaged before using the product.
- Do not overload the stroller with additional children, bags, other items or accessories.
- The maximum weight that can be hung from the handlebar is 4kg when the seat is in the forward facing position and 1kg in the parent facing position
- Please hold the handlebar at all times when bags are attached to avoid a tipping hazard. If you're on a sloping surface or your child is moving around in the seat it may become unbalanced.

- Do not allow children to stand on the axle/brake bar between the wheels. This is unsafe and could damage the stroller.
- The brake must always be applied when the stroller is not moving.

### Maximum weight limits

- Maximum weight for a child in the seat is 22kg.
- Maximum weight for items in the basket is 8kg.
- Maximum weight to be carried on the handlebar bag is 4kg with the seat forward facing and 1kg with the seat in the parent facing position.

### Others using your stroller

- If the stroller is being used by someone unfamiliar with it (such as grandparents) always explain to them how the stroller works and its safety features.

### Supervision

- Never leave your child unattended with the stroller. It should only be used under adult supervision.

### Toddler Board

- Milo is compatible with the Milo Toddler Board, sold as

a separate accessory. The maximum weight of a child on the toddler board is 20kg.

### Bassinet Specific

- The maximum weight that can be carried in the bassinet is 9kg.
- Not to be used for overnight or unsupervised sleeping.
- Only use the bassinet in a flat position.
- Do not recline.
- Do not add additional mattress or padding inside the bassinet.
- To reduce the risk of SIDS, paediatricians recommend healthy infants be placed on their backs to sleep, unless otherwise advised by your physician.

## WARNING

DO NOT USE THIS BASSINET  
ONCE THE CHILD CAN SIT  
UP UNAIDED.

## WARNING

USE THE TETHER STRAP TO  
STOP THE PRAM/STROLLER  
ROLLING AWAY



**You're now  
ready to set  
up your Milo!**

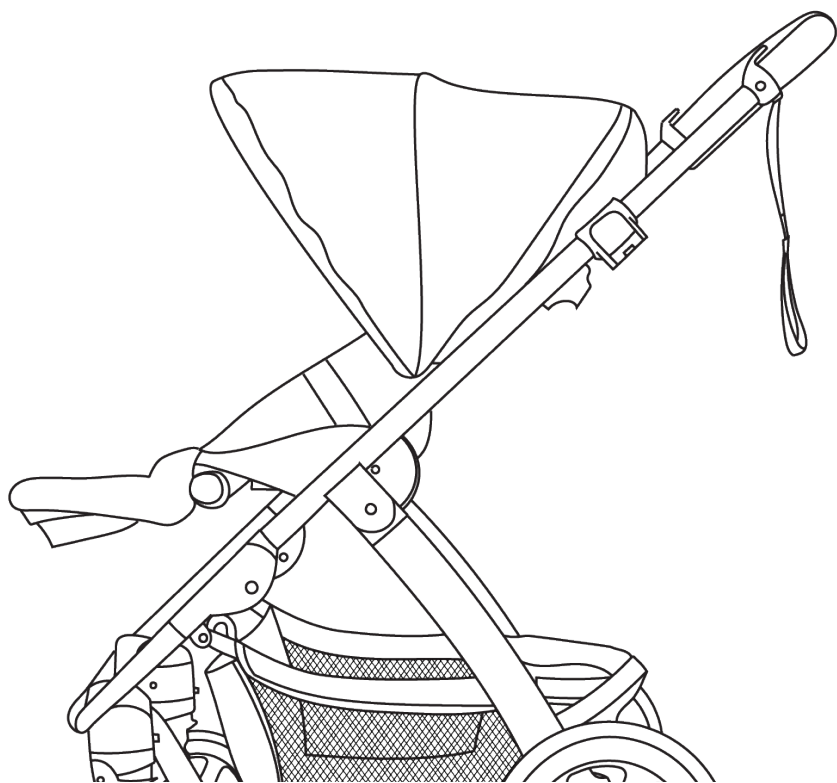

# Setting up your Bassinet

- + Lift the bassinet canopy up until it clicks into place.

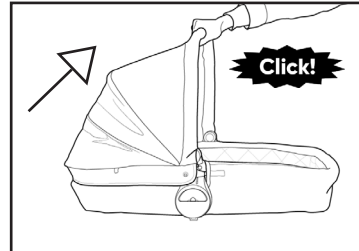

- + Press down on the bassinet base whilst pulling up on the canopy by the canopy handle to erect the bassinet.

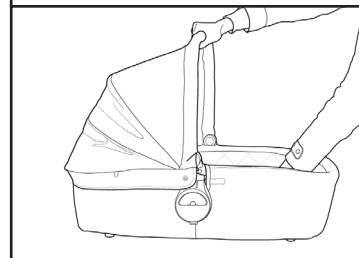

- + Using the fabric straps, pull the frame support rods towards the ends of the bassinet until they lock under the 4 plastic clips. Tip: if they don't insert easily simply lift the clip up to help guide the rods into place.

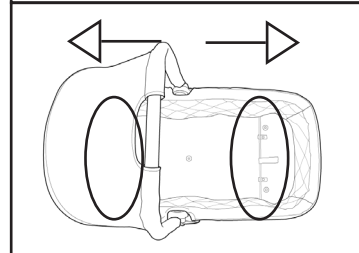

- + Insert the bassinet mattress. Tip: many parents like to wrap their mattress in a muslin cloth or similar to make cleaning easier.

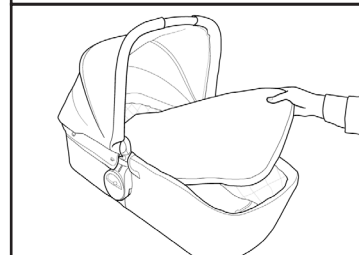

- + Attach the bassinet cover using the Velcro and press studs on each side.

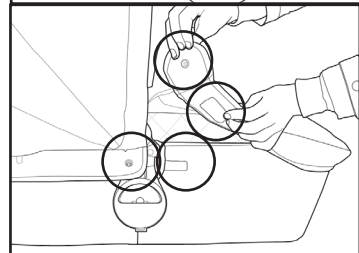

# Attaching + Removing the Bassinet

For safety reasons, we recommend removing your baby prior to attaching or removing your bassinet.

- + Ensure the brake is engaged. Attach the bassinet adaptors.
- + Hover the bassinet over the bassinet adaptors and push down until you hear a click. Pull up on the canopy handle to ensure the bassinet has securely locked into place.
- + To remove the bassinet, lift the release lever at the back of the canopy all the way up and use the handle to lift the bassinet up and off the frame.
- + To remove the bassinet adaptors simply press the buttons in the middle of the adaptors and lift up.

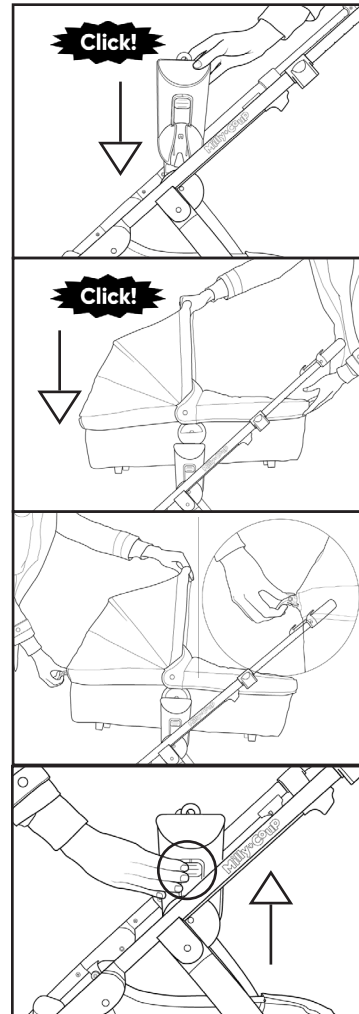

# Using your Milo Bassinet

**+** To adjust the canopy, press the two buttons on the inside sides and lower the canopy to the desired position (note: there are 2 canopy positions).

**+** To raise the canopy simply lift it back up; no need to push the buttons.



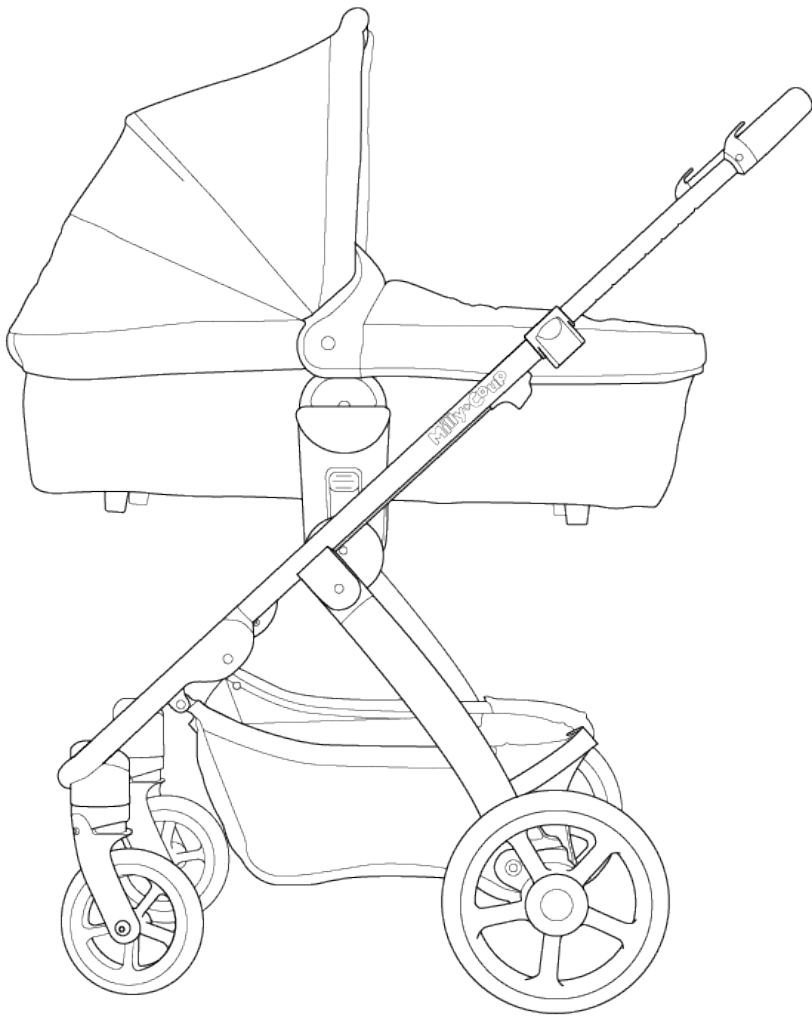

Ready to rock + stroll!

# Setting up your Frame

- + To release the frame from the folded position, pull back the black plastic frame lock on the left hand side of the frame and lift the handlebar up to open the frame.

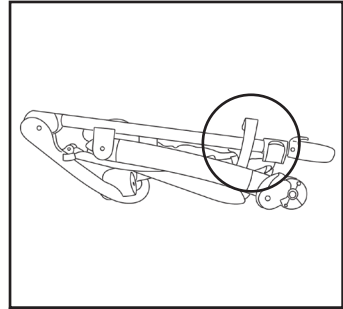

- + To adjust the handlebar to your desired position, unclip the handlebar locks located on each side of the frame and pull or push to your desired height. Note the grooves underneath the frame bar. It needs to be sitting within a groove for the locks to be able to close. If you find they won't close simply give the bar a jiggle to find the nearest groove.

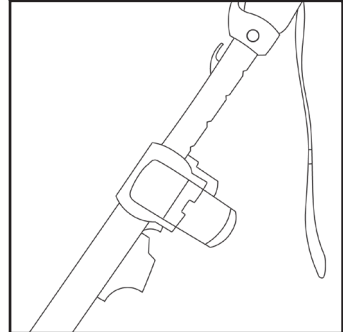

- + To attach the rear wheels to your frame push each wheel pin into the sides of the rear axle until you hear a "click". Give them a tug to ensure they are attached securely.

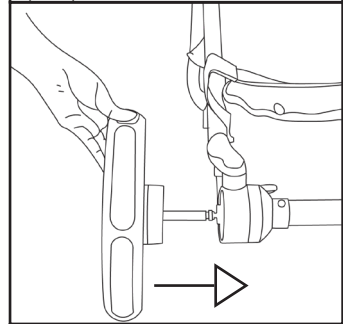

- + Next, insert each front wheel pin into the centre of the front wheel socket ensuring you hear them "click" in. Give each wheel a firm tug to ensure they are secure.

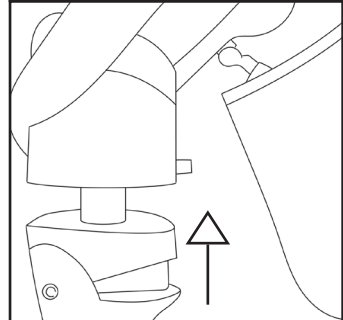

# Setting up your Seat

- + Line up the round plastic seat connectors with the frame and press the seat downwards.

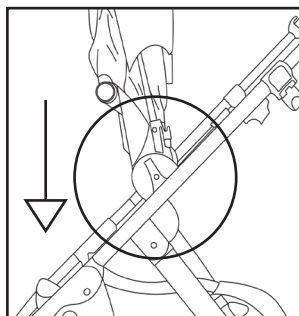

- + Push the foot rest down into place and the back of the seat backwards until they both lock firmly into place in a normal seated position.

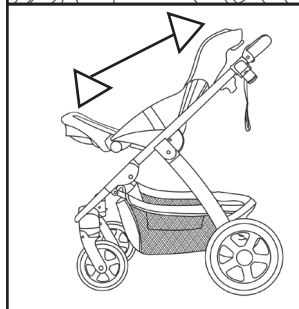

- + To adjust the foot rest, using both hands, press the round buttons on the sides of the foot rest and adjust down to your required level. No need to push them to adjust it up.

To recline the seat, fully lift the seat recline latch located on the back of the seat and adjust the seat forward or back.

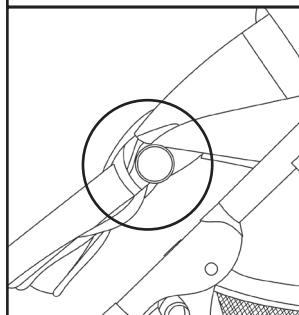

## Tips to avoid tears

The strap hanging from your handlebar is a wrist tether strap. Please ensure you slip your hand through here whenever you're using the stroller. It's designed to prevent the stroller rolling away and is a requirement of the Australian & New Zealand Standards for all prams and strollers.

# Removing your Seat

**+** The seat can be faced in a forward or rear facing position.

**+** To remove the seat, lift the foot rest and lower half of the seat up to meet the seat back, simultaneously lifting the seat recline latch and lifting the entire seat unit directly up and out of the black plastic seat connectors.

Don't worry if it feels awkward at first, you'll be doing it with your eyes closed in no time!

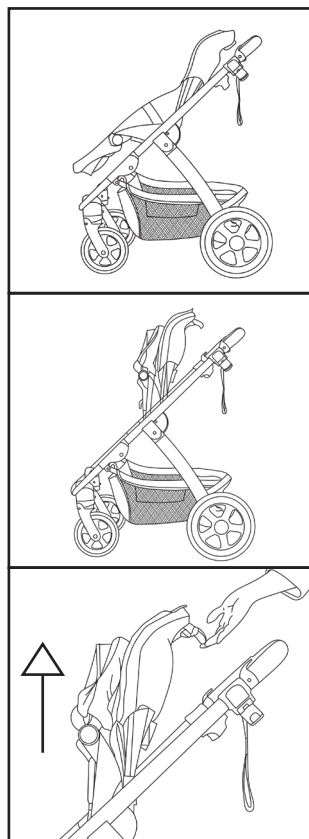

## Tips to avoid tears

### USING THE STROLLER WITH A BABY UNDER 6 MONTHS

The seat must be fully reclined to the flattest position. (An upright or semi reclined seat can increase the risk of your child's head tilting/falling forwards resulting in reduced airflow which can lead to serious injury or even death).

Always use the harness with all 5 straps secured.

The seat can be used with or without the newborn insert.



# Setting up your Canopy

**+** To attach the canopy, make sure the seat is in the parent facing position to give you room away from the frame.

**+** Attach the plastic canopy connectors onto the sides of the frame (tip: gently pull both sides out to widen the connector gap). The connectors are designed to be tight so as not to become loose overtime. If you are struggling to attach them, try tipping the stroller onto one side and attach the side facing up. Then turn the stroller over and repeat on the other side.)

**+** Next press the button on the back of the canopy connectors and slide the connectors up until they click into the second position. This will give taller toddlers additional headroom.

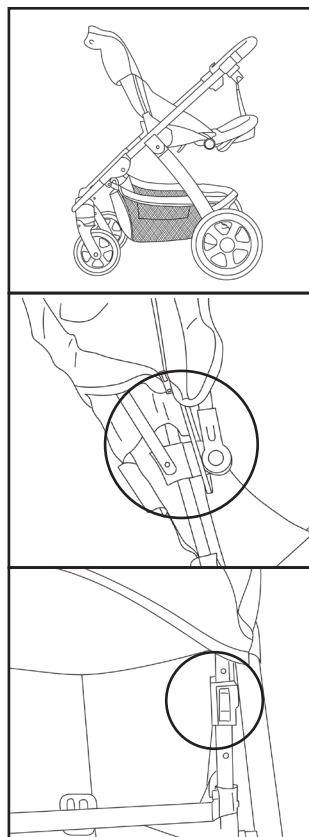

# Setting up your Canopy

- + Secure the canopy to the seat using the four press studs.

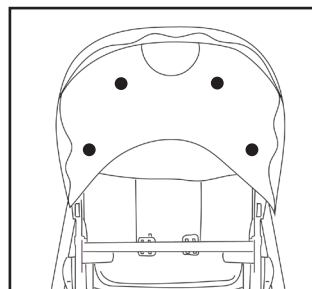

- + The canopy can be extended using the zipper.



# Adjusting your Harness

## To secure the harness:

- + Using the strap buckles, adjust the length of each strap to ensure it fits nice and snug.
- + Attach each of the 4 harness straps into the central buckle (they must be facing the correct way to insert).

Always give the harness a tug to ensure it's secure.

To release press the button in the middle of the buckle.

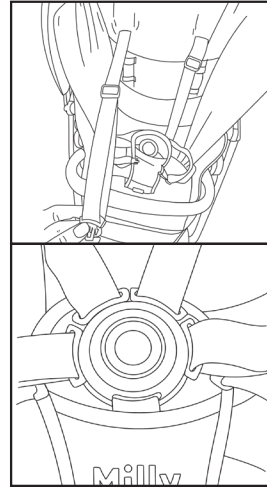

## To adjust the height of the harness straps:

- + Depending on your child's height, thread the shoulder strap through the appropriate slot on the seat.
- + Ensure it is thread through the corresponding slot of the seat liner or newborn insert. Adjust the strap length using the buckle as required.

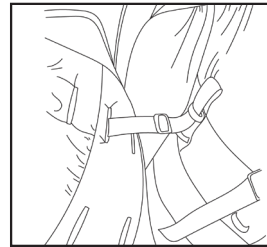

## Tips to avoid tears

Please ensure that your child correctly wears the fitted and adjusted safety harness at all times with all 5 straps secured.

Never leave the harness buckled when not fitted to the child in the stroller.

The harness can form loops which may cause a strangulation hazard.

**⚠ WARNING** USE THIS HARNESS AT ALL TIMES.

ALWAYS USE THE HARNESS WHEN YOUR CHILD IS IN THE STROLLER.

ALWAYS ADJUST THE HARNESS APPROPRIATELY FOR YOUR CHILD'S SIZE.

# The final steps

- +** Insert the belly bar into the belly bar slots on the seat frame. Always give the bar a firm tug to ensure it is secure. (Note: To remove from one side or both, press the button on the side you want to release, and pull the belly bar out.)

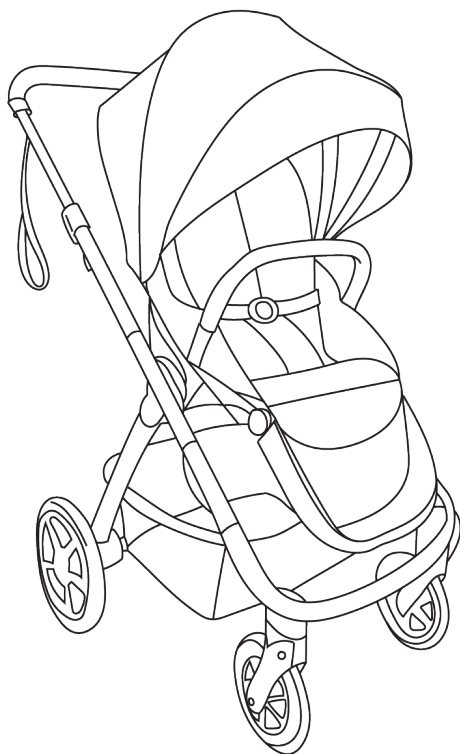
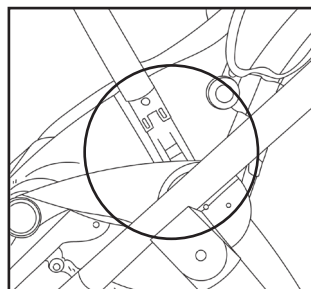

## Ready to rock + stroll!

# Using your Milo

## Rear brake

When stopped, use the brake at all times by pressing down on the bottom of the red brake paddle with your foot until you feel it click into place. To start travelling again press down on the top of the red paddle with your foot to disengage the brake and off you go!

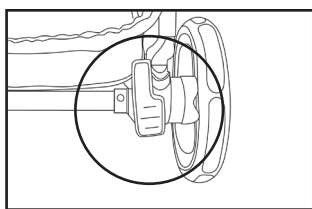

OFF

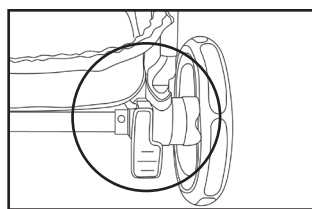

ON

## Front wheel locks

When travelling fast along straight surfaces or across uneven terrain, the front wheels may spin or cause what's known as "wheel shudder".

To lock the front swivel wheels into place, engage the wheel lock buttons (located on the back of the front wheel sockets).

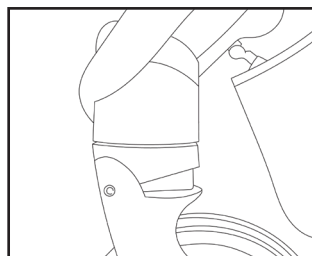
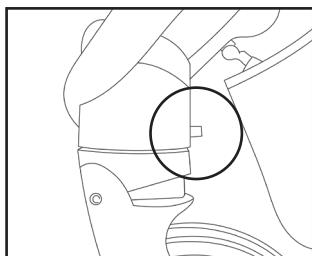

## Tips to avoid tears

Do not allow your child to climb, stand or play on the stroller.  
To avoid tipping, do not allow your child to climb unassisted into the stroller.

## Basket

The Milo basket has been tested to hold 8kg. Overloading the basket with more weight may cause the basket to break. To remove the basket simply undo the zips around each bar as well as the fabric loop around the top.

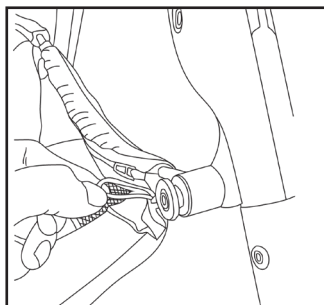

## Adjusting the handlebar

Unclip the handlebar locks located on each side of the frame and pull or push to your desired height. Note the grooves underneath the frame bar. It needs to be sitting within a groove for the locks to be able to close. If you find they won't close simply give the handle a jiggle to find the nearest groove.

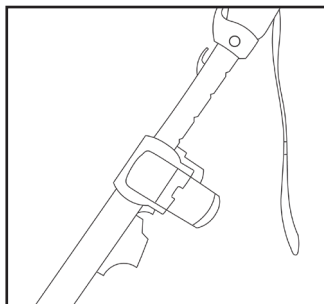

## Reclining the seat

Fully lift the seat recline latch (located on the back of the seat) and recline the seat to the desired position.

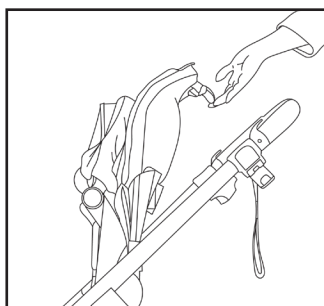

## Tips to avoid tears

Remove your child from the seat and fold the stroller before going up or down stairs or escalators.  
Take your child out of the stroller when travelling by bus, tram or train.

## Reversing the seat direction

- ✚ To remove the seat, lift the footrest and base of the seat to meet the seat back whilst simultaneously lifting the seat recline latch fully (located on the back of the seat) and moving the seat back forward until both parts touch.
- ✚ Lift the seat unit directly up and out of the round plastic connectors.
- ✚ Turn it around and again line up the round plastic seat connectors with the frame and press the seat downwards.
- ✚ Push the foot rest down into place and the back of the seat backwards until they both lock firmly into place in a normal seated position.

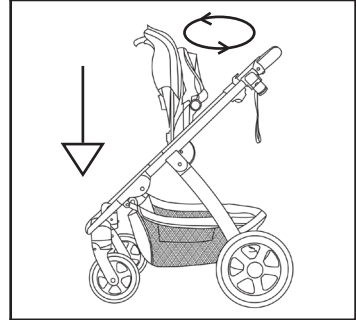
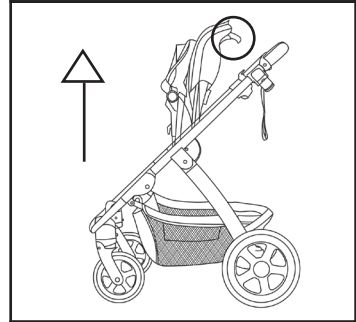

# Folding the stroller

- ✚ The stroller can be folded with the seat on facing either direction. Before folding, ensure that the front wheels are unlocked.

Adjust the handlebar to the lowest position and ensure that the locks are securely closed.

- ✚ Lift the primary lock up with your forefinger (located on the right frame release lever) before simultaneously pulling both frame release levers up towards you as far as they go.

- ✚ Push downwards on the handlebar and the frame will collapse onto the floor

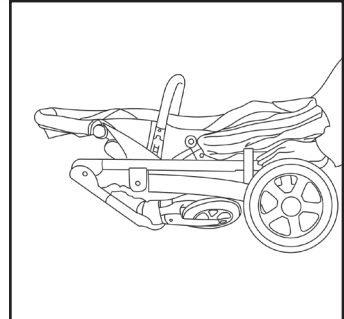
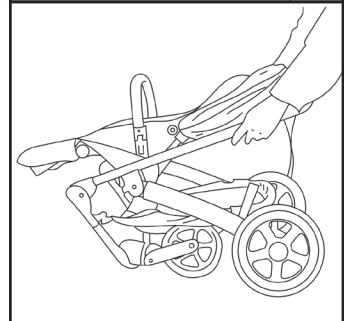
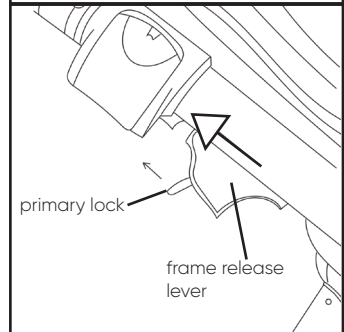



- + Seat forward facing:  
You can then pull the footrest section flat against the seat.

Seat parent facing:  
Lift the seat recline latch up before pulling the seat back to meet the footrest section.

- + Ensure the black plastic frame lock has engaged to prevent the frame from opening whilst carrying.

- + Lift the frame up from the handlebar and carry the stroller.

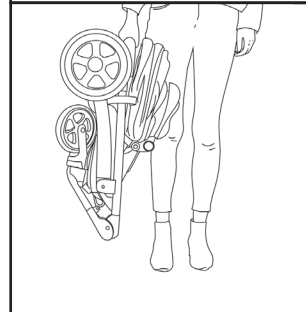
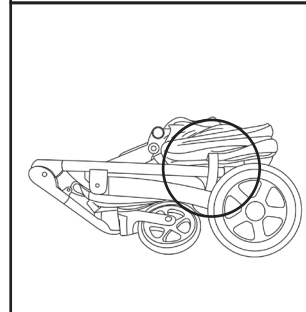
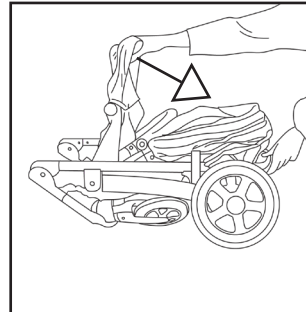

## Tips to avoid tears

Always remove the car capsule and adaptors prior to folding.  
Ensure children are out of reach of the stroller before folding.  
Ensure the frame lock is secured and the handlebar locks are on before carrying.  
Bend from the knees and use safe lifting practices when lifting and carrying the stroller.  
Take care when folding and unfolding the stroller as there is potential for fingers or other body parts to be injured.

# Using Milo with a car capsule

Connect a compatible car capsule to your Milo Stroller using our **Milo Capsule Adaptors**.

**NOTE: Milo Capsule Adaptors are sold separately to your Milo stroller.**

The following car capsules are compatible with the Milo Capsule Adaptors:

- Maxi Cosi Mico (manufactured from 2014 onwards)
- Maxi Cosi Mico AP (manufactured from 2013 onwards)
- Maxi Cosi Mico Plus
- Maxi Cosi Mico AP limited edition
- Cybex Cloud Q

---

## To attach

1. Apply the brake and remove the seat/bassinet from your stroller.
2. Click on the two adaptors to the corresponding central connector points on the stroller frame where you would normally attach the seat. **Note:** when standing behind the handlebar (as if you were pushing the pram), the "L" labelled adaptor goes on your left.
3. Attach the car capsule onto the adaptors with the capsule facing the stroller handlebar and ensure it clicks in securely.

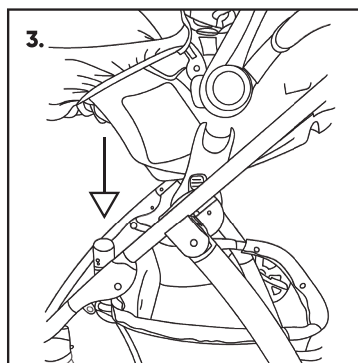
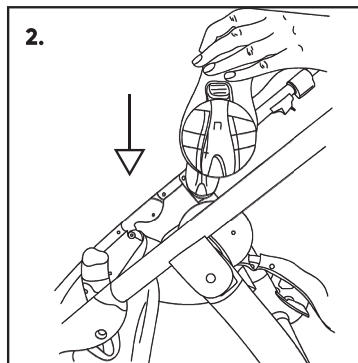

## To remove

1. Press the release buttons on the capsule where circled.
2. Whilst pushing the buttons, lift the capsule off the adaptors, holding the round central section on the capsule for stability.
3. Push the release buttons on the adaptors to remove them from the frame.

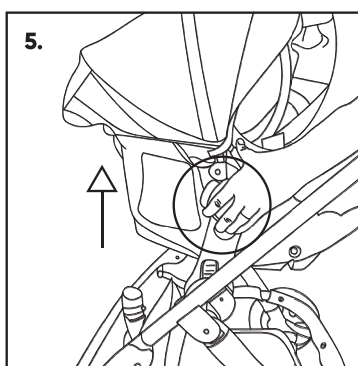
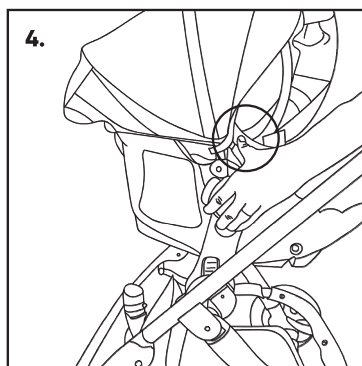

## **⚠ WARNING**

- FOLLOW THE MANUFACTURER'S INSTRUCTIONS CAREFULLY TO PREVENT INJURY OR EVEN DEATH.
- READ MANUFACTURER'S MAXIMUM USAGE TIME THAT BABIES CAN REMAIN IN YOUR SPECIFIC CAPSULE FOR. THIS IS GENERALLY BETWEEN 90-120 MINUTES.
- DO NOT USE MILO CAPSULE ADAPTORS WITH ANY CAPSULE NOT AUTHORISED BY MILLY + COUP.
- NEVER LIFT THE STROLLER OR CAPSULE WHILE THE TWO ARE ATTACHED.
- ENSURE ALL FINGERS AND BODY PARTS ARE CLEAR OF THE CAPSULE AND STROLLER FRAME WHEN ATTACHING.
- NEVER PLACE THE CAR CAPSULE IN THE CAR WHILE ADAPTORS ARE ATTACHED.
- DO NOT PLACE OR HANG ANY ACCESSORIES ON THE CAPSULE WHILST ON THE STROLLER. THIS MAY CAUSE YOUR STROLLER TO TIP.

# Accessories

## Rain cover

Pull the rain cover over the top of the canopy and then over the footrest as shown. Never leave the stroller covered indoors, in very hot weather or near a heat source. Always supervise and monitor your child regularly whilst the stroller is covered.

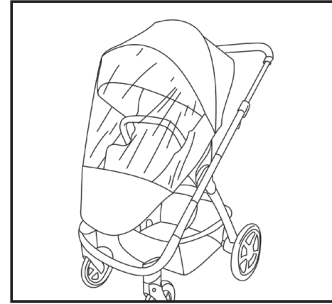

---

## Newborn Insert

Recline the seat fully before placing the insert onto the seat. Adjust the head cushion based on your baby's size.

Next adjust the harness to be the right length for your baby.

For a newborn, the shoulder straps should be threaded through the lowest loop on the seat before threading through the corresponding slot on the insert.

Waist straps should also be threaded through the slots on the insert.

For larger toddlers, the straps can be moved around the outside of the insert, not threaded through the strap slots (as pictured).

**Newborn  
option**

**Toddler  
option**

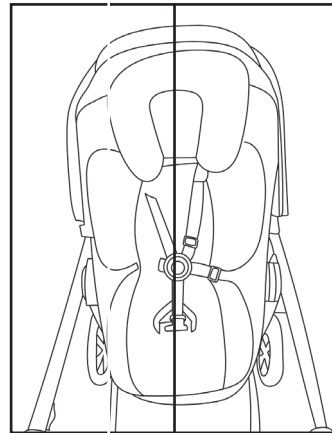

---

## Newborn UV cover

With the seat in the parent facing position and fully reclined for newborn use, you can attach the UV cover to provide greater protection for your little one. Simply loop the elastic loops around the plastic slots on the handlebar. Cover the other end over the fully extended canopy and do up the toggles below the canopy connectors on the seat frame.

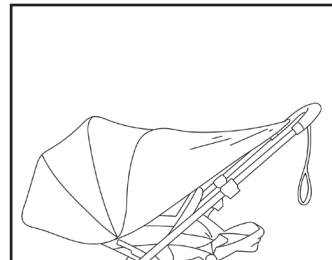

# Milo Maintenance

Please use and treat Milo with respect and care. Your stroller will need to be given regular maintenance to remain safe and in good condition. Please be gentle, don't overload it, avoid excessive off road use and be sure to follow the maintenance instructions below to keep your stroller looking and feeling newer for longer!

## Regular maintenance:

- 1.** Inspect the locking devices, levers, joints, buttons, brakes, wheels, safety harness and fixtures to ensure they are secure, moving freely and in fully working order.
- 2.** If any parts of the stroller have become stiff, difficult to operate or begin to squeak, first ensure that dirt is not the cause. Then try a light application of a sprayable silicone lubricant, ensuring that it penetrates between the components. (Note: Only use lubricant labelled 'Silicone Lubricant', as other lubricants can deteriorate the plastic parts of your stroller and also attract dirt and dust e.g. DO NOT use standard WD-40). We recommend WD-40 SPECIALIST Silicone Lubricant or SCA Silicone Spray available from Supercheap Auto, Bunnings and most hardware stores.

## **WARNING**

POISONOUS, TOXIC SUBSTANCE.  
USE WITH CARE.

Ensure children are not present when applying silicone lubricant or allowing it to dry. Always spray outside or in a well ventilated area. Ensure you use minimal product and wipe away excess solution before use.

- 3.** Follow our cleaning instructions on the next page.

## Correct Use

Milo has been designed for urban living and weekend adventures which means it's ideal for walking on sealed footpaths, in shopping centres, cafes and down at your local park. Taking Milo off-road or over uneven terrain will clearly place more stress on the frame and wheels and cause the stroller to wear out faster. For this reason we recommend "weekend adventures" and not regular off-road use.

## Correct Storage

Do not leave Milo in direct sunlight for prolonged periods of time to avoid colour fade.  
Do not leave Milo in your car on days of extreme heat or near any heat source or fire.  
Do not store Milo with heavy items on top of it, this may misalign the frame. Store Milo in a dry, well-ventilated and safe place.

## Preventing rust & mould

After exposure to wet or damp conditions (especially trips to the beach, snow or in the rain), leave Milo fully open in a warm, well ventilated environment to prevent rust and mould. You may need to dry the stroller with a soft, lint free cloth. Left damp it will encourage mildew, mould or rust to form causing damage.

# Cleaning Instructions

To keep your stroller looking and functioning like new, we recommend a deep, comprehensive clean every 6 months.

For a full guide on how to clean your pram, please refer to our website.

- +** Use a soft brush to brush Milo down and remove any dirt or dust, making sure you get into all the nooks and crannies (i.e inside the wheel hubs, inside the joints from all folding parts etc). You could also give it a good vacuum.
- +** At the first sign of rust, remove with steel wool.
- +** All plastic, fabric and metal parts may be sponged clean with a soft cloth in warm water and a mild detergent.
- +** Wipe dry with a soft towel or cloth and allow all parts to dry thoroughly before using.
- +** The seat liner and newborn insert are machine washable on a delicate setting (maximum water temperature of 30°C) however, handwashing will keep them looking newer for longer.

---

## DO NOT

- Do not immerse the seat or canopy in water, sponge clean only.
- Do not clean with abrasive materials or using ammonia, bleach, solvents, caustic or spirit-based cleaners.
- Do not press or iron.
- Do not rub or wring fabric.
- Do not tumble dry.
- Do not dry clean.

## WARNING

- Do not clean your stroller with children around.
- Do not remove, dismantle or alter any part of the folding mechanisms, frame, brake axle or wheels for cleaning or any other reason.
- Do not use if any part is broken, torn or missing. Replacement parts are available from our website or by contacting us.

Failing to adhere to these maintenance and cleaning instructions could damage or effect the safety of your stroller and may void your warranty.

# Spare Parts

The wheels are subject to normal wear and tear and should be replaced if necessary.

Spare parts are available for purchase on the Accessories & Spare Parts page of our website ([millyandcoup.com](http://millyandcoup.com)). If the part you require is not listed, please email us for a quote at

**[au.support@millyandcoup.com](mailto:au.support@millyandcoup.com)** or **[nz.support@millyandcoup.com](mailto:nz.support@millyandcoup.com)**



## Enjoy the ride!

## **Contact Milly + Coup**

[au.support@millyandcoup.com](mailto:au.support@millyandcoup.com)

[nz.support@millyandcoup.com](mailto:nz.support@millyandcoup.com)

 Milly and Coup  @millyandcoup

Model: 2020 Milo Bassinet + Stroller Bundle

Version: 2 – November 2021

Information subject to change.

Please see website for current version.

**[millyandcoup.com](http://millyandcoup.com)**