

# HANGERS

FUSION SIGNATURE SOFT CLOSING DOOR INSTALLATION GUIDE



## DOOR CONFIGURATION

Two door systems:

One rear, One front.

Three door systems:

Two rear doors (Outside) One front door (Centre)

Four door systems:

Two rear doors (Outside), Two front doors (Centre)

Five door systems:

Two rear doors (Outside), Three front doors (Centre)

## STEP 1

Instruction:

The rear doors are always fitted first and then the front doors last.

Carefully lift the rear door into position in front of the wardrobe.

Stand it up so that the bottom of the door is located about a foot away from the threshold.

Lean the top of the door backwards until the top of the door is under the top track.

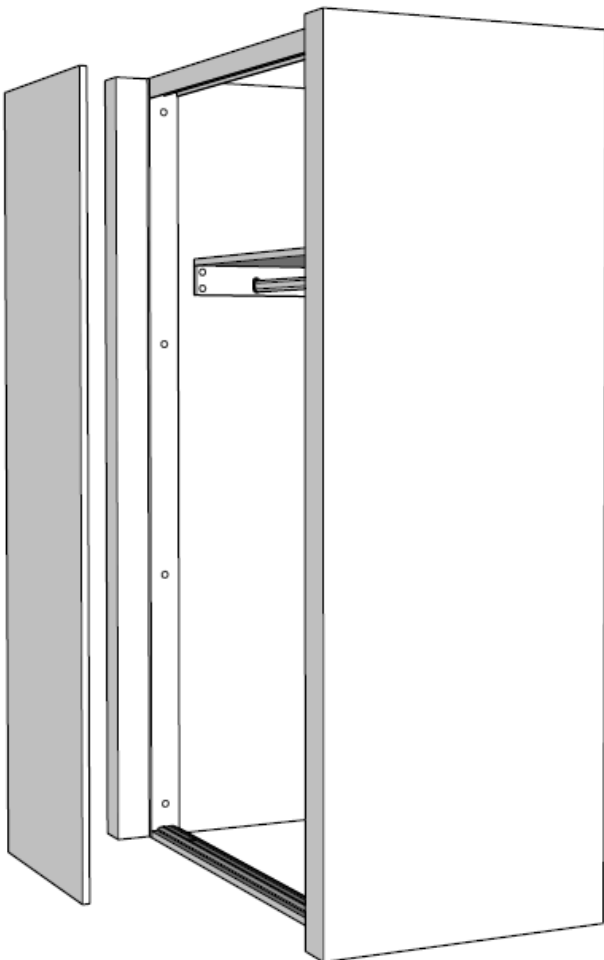

## STEP 2

Instruction:

Carefully lift the door so the top locates in the rear section of the top track.

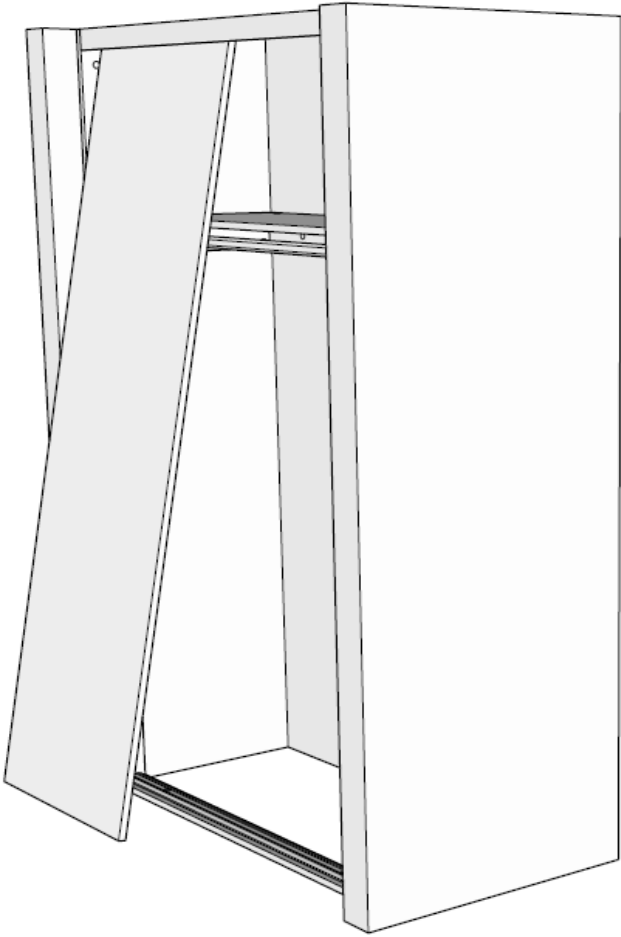

## STEP 3

Instruction:

With the top of the door located in the top track, manoeuvre the bottom of the door over the bottom track so that the running wheels are directly over the bottom track running guides.

Lower the door so the wheels locate in the running track guide.

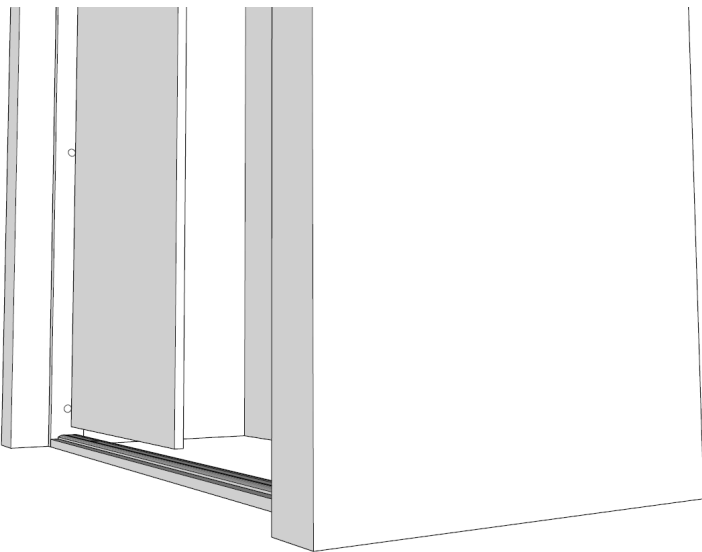

#### STEP 4

For this step, you will need the following tools:

Cross head screwdriver

Instruction:

Before sliding the door from side to side the wheels will need to be lowered slightly to lift the door and avoid the bottom of the door scratching the bottom track.

Locate the wheel assembly in the rear fascia of the door at the bottom.

Turn the adjusting screw with a cross head screwdriver two clicks clockwise on both wheels.

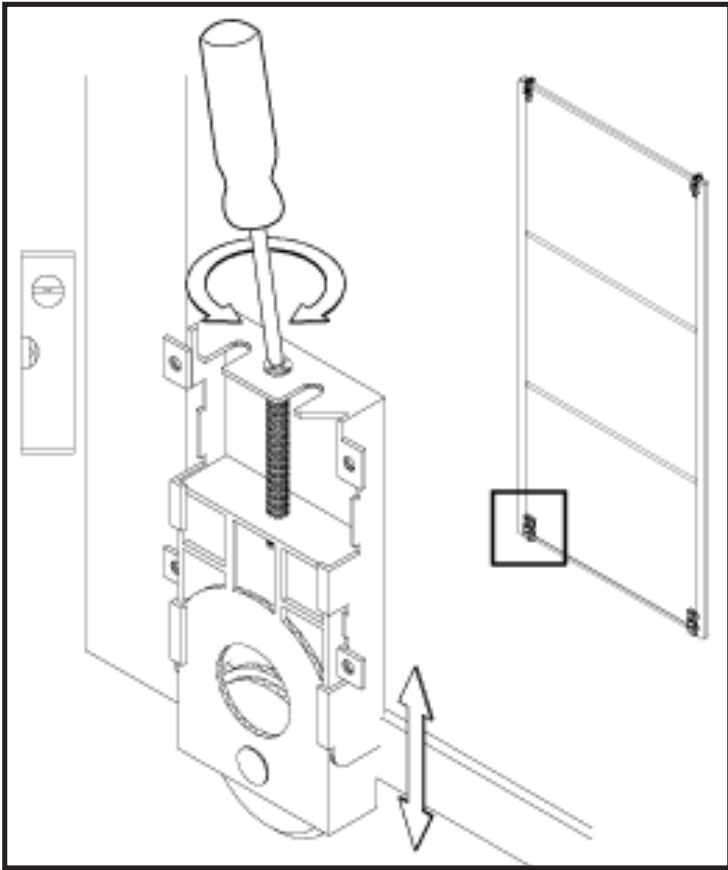

#### STEP 5

Instruction:

Slide the door from side to side to ensure of a running motion.

Slide the door up to one of the side liners and hold in position.

If there is a gap at the bottom of the door to the side liner then the screw/wheel closest to the side liner will have to be adjusted. This is located in the diagram as '1'

If there is a gap at the top of the door then the screw/wheel furthest away from the side liner will have to be adjusted. This is located in the diagram as '2'

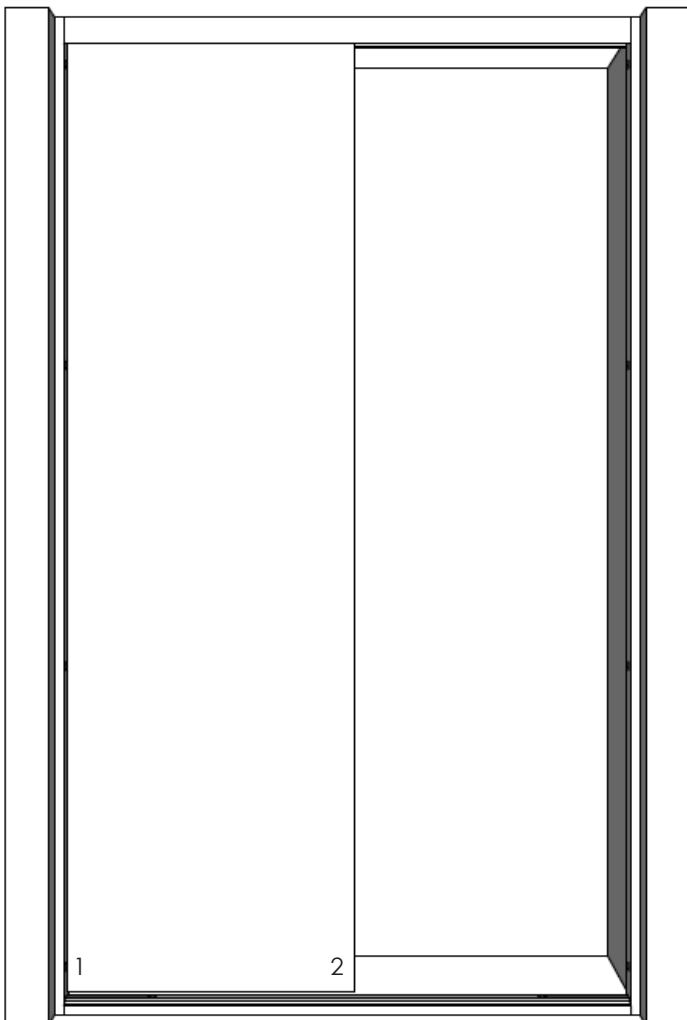

## STEP 6

For this step, you will need the following tools:

Cross head screwdriver

Instruction:

Whilst holding the door against the liner, keep turning the relevant screw until the gap from the door to the side liner has been closed up and no longer exists.

Open and close the door again and leave against the side liner without holding the door to ensure that the gap has totally gone.

Keep adjusting the screws until all gaps have gone.

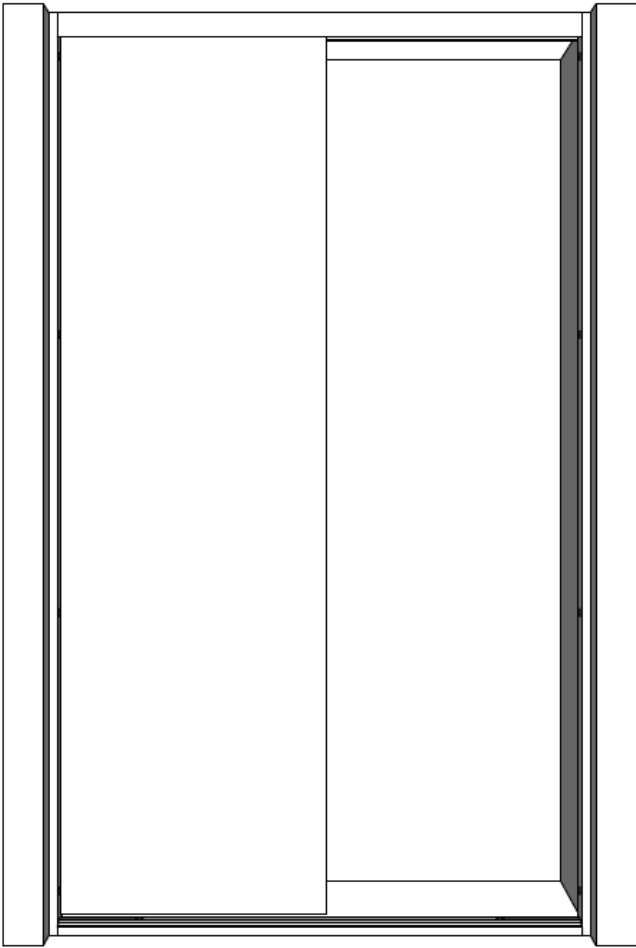

## STEP 7

Instruction:

Repeat for remaining doors on the wardrobe.

When all doors have been fitted, the doors that are against a side liner when in it's closed position can now have soft close fitted.

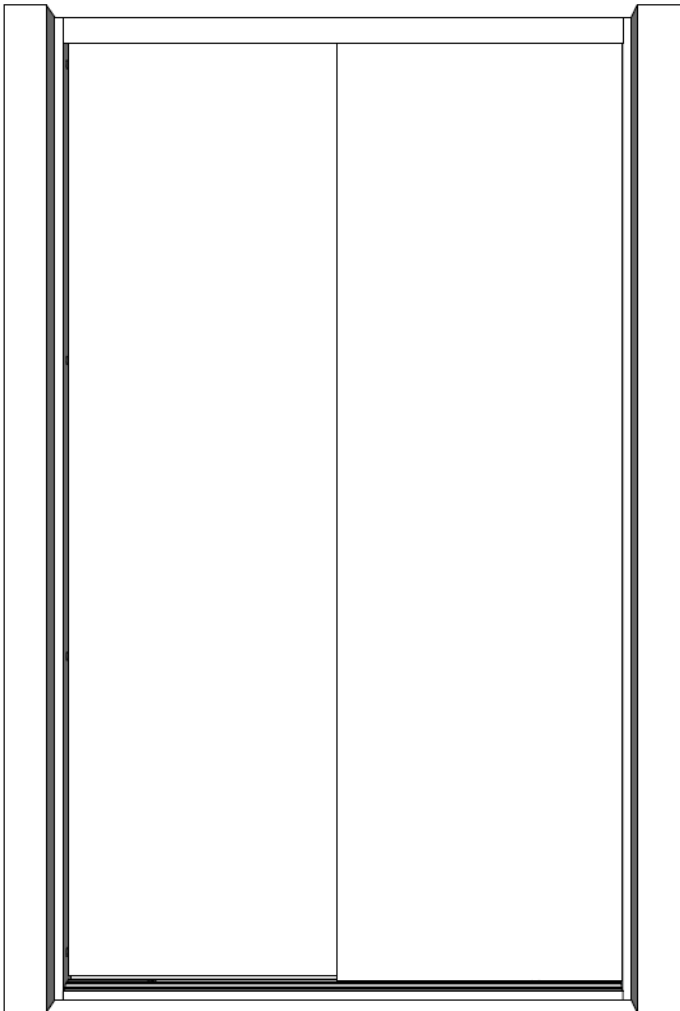



## STEP 8

### Instruction:

After the doors have been fitted and adjusted to their specific side, the soft close function can now be fitted.

This is made up of two parts, the activator is fitted in the top track and the damper is fitted to the top of the door.

Please note that the damper will already be fitted to the top of the door.



## STEP 9

### Instruction:

Pull the green indicator pin down. This will indicate whether the door is in the correct height position by sounding a clicking noise when closing the door.

Close the door and listen for the pin to click.

If the pin does not click, then turn the silver adjusting screw half a turn clockwise and try again.

Keep trying and adjusting until you can hear the click.

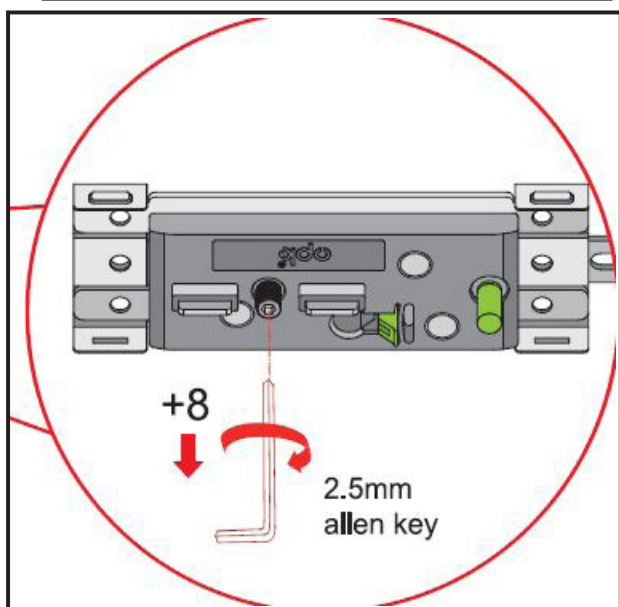
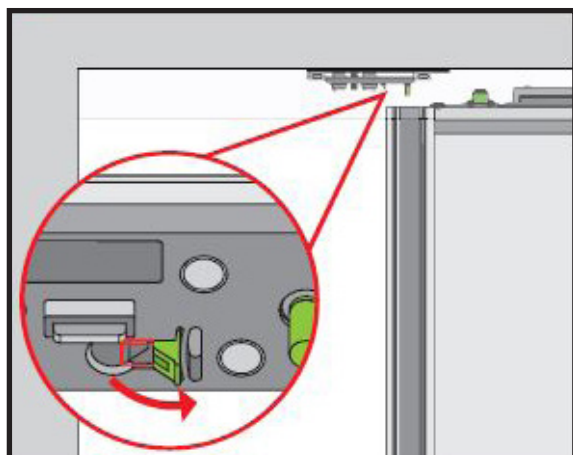

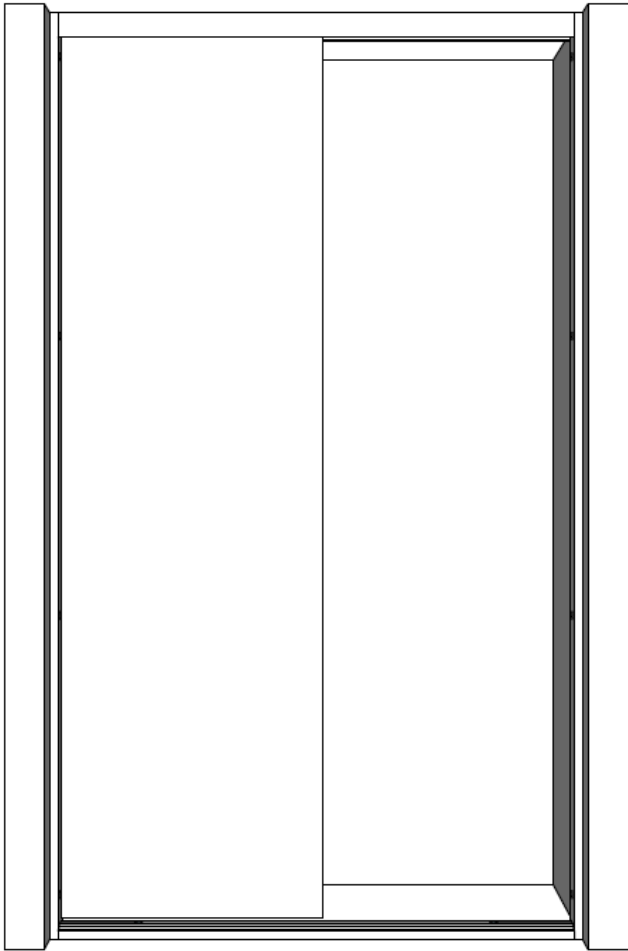

#### STEP 10

##### Instruction:

After the door has closed and the pin clicks to indicate the height level is okay, open and close the door.

When you are closing the door, as it gets towards the close position let it go so it closes by itself to check that the soft close engages and closes fully.

If the door does not close fully and a gap remains, then the activator needs to be moved closer to the edge of the wardrobe - Carefully slide the activator towards the edge of the wardrobe approximately the distance of the gap left when closing the door. Re-test by opening and closing the wardrobe. Repeat until the gap has gone.

If the door closes too abruptly and the soft close does not engage then the activator is too close to the edge of the wardrobe and needs to be moved towards the middle of the wardrobe - Carefully slide the activator towards the middle 5mm and re-test opening and closing the door. Repeat until the soft close engages and there is no gap left in the door.

#### STEP 11

##### Instruction:

When the correct height has been confirmed by the green catch clicking, the soft close function closes the door correctly with no gaps the activator can be secured to the top track using 2 x 20mm screws.



Repeat for the opposite side of the wardrobe.