



MEMPHIS OWNER'S GUIDE

ITC 3 IntelliBurn Technology™ Models:

Elite Cart, Pro Cart, Elite Built-in, Pro Built-in



Read all instructions before installing and using this appliance.

Save these instructions for future reference.



Table of Contents

General Warning: Safety information	3
How your Memphis Wood Fire Grill works	5
Built-in Installation	6
Read prior to lighting	7
Intelligent Temperature Control	8
Wi-Fi Setup Guide	18
Using your Memphis Wood Fire Grill	19
Operating instructions	20
Memphis ITC Meat Probe	22
Memphis EZ-Access (Indirect) Savorizer®	23
Memphis Direct Flame Savorizer® Insert	24
Information about BBQ cooking pellets	25
Periodic grill maintenance	26
Recommended grilling accessories	28
Food handling and safety	29
Grilling times and temperatures	30
Smoking guidelines	32
Smoking suggestions	33
Troubleshooting	34
Fuse Information	35
Limited warranty	36
Warranty Registration form	39

GENERAL WARNING: Read all safety information prior to operating grill



- Please read this entire manual before installation and use of this wood pellet fuel-burning appliance. Failure to follow these instructions could result in property damage, bodily injury or even death.
- This appliance is not intended for use by persons (including children) with reduced physical, sensory or mental capabilities, or lack of experience and knowledge, unless they have been given supervision or instruction concerning use of the appliance by a person responsible for their safety.
- Children should be supervised to ensure they do not play with the appliance.
- Contact local building or fire officials about restrictions, installation and inspection requirements in your area.
- Save these instructions.
- For outdoor use only. Do not use in any enclosed area.
- Keep grill 30" (76 cm) or more from any combustible surface.
- To prevent grease fires, clean your grill on a regular basis; this includes the Savorizer® and grease tray.
- Do not put anything flammable in the storage area under the grill or in either shelf.
- Do not leave sealed containers of food on or near the grill.
- Keep the grill's rear and top ventilation slots clear of obstructions.
- It's recommended that you regularly check your Memphis Grill for burn pot obstructions to make sure proper air flow is maintained. See [Periodic Grill Maintenance](#) in this manual for correct procedures.
- DO NOT cover Savorizer® with foil; this will impede air flow.
- Accessible parts of the grill are very hot. Exercise reasonable care when operating your grill. Keep young children away while in use. When children are present, adult supervision is recommended.
- Do not use lava rocks or charcoal in your grill.
- Always use premium barbecue pellets. Wood pellets produced for heating stoves should not be used.
- Should a grease fire occur, turn off the grill, remove food (use your judgment), and leave the hood closed until the fire is out. Do not unplug the grill unless absolutely necessary; fans will continue to run until the fire is extinguished. When cooking exceptionally greasy foods, put a foil pan below the food to catch the grease.
- Never use gasoline, gasoline-type lantern fuel, kerosene, charcoal lighter fluid, or similar liquids to start or 'freshen up' a fire in this appliance. Keep such liquids well away from the appliance when in use.
- Ashes should be placed in a metal container with a tight-fitting lid. The closed container of ashes should be placed on a non-combustible surface, well away from combustible materials, pending final disposal. When the ashes are disposed by burial in soil or otherwise locally dispersed, they should be retained in the closed container until all cinders have thoroughly cooled.
- To avoid the chance of serious burns, never lean over an open grill or place hands or fingers on the front edge of the grill when hot.
- Do not use accessories not specified for use with this appliance.
- The grill should be plugged into a GFCI (Ground-Fault Circuit Interrupt) outlet, preferably on a dedicated circuit.
- The grill is to remain plugged into a GFCI during the cool down cycle.
- When not in use, the grill should be unplugged, or be powered off via post purchased dedicated on/off switch.
- Use heat-resistant barbecue mitts or gloves when operating this unit.
- Do not move or clean the grill while operating or while the grill is hot. Make sure the fire is completely out, and that the grill is completely cooled before transporting or cleaning the grill.
- If the power cord becomes damaged, do not operate the grill.
- If the supply cable is damaged, it must be replaced by the manufacturer, its service agent, or similarly qualified persons in order to avoid a hazard.
- Do not use aerosols, liquids or damp materials on or near the grill while it is hot.
- Do not cover the entirety of the cooking surface when grill is hot. Leave at least 2 inches of clearance from the sides and back of the grill body.
- Any modifications (holes, screws, sheet metal changes) to the grill will void warranty.
- Always operate the grill with the grill hood in the closed position, unless the grill is in a Direct Flame mode.
- The grill is never operated in a Direct Flame mode without the optional Direct Flame Savorizer® Insert (VG4407). The EZ-Access or Direct Flame Insert must be in place during operation. Direct Flame cooks should be performed with the hood in the open position. A closed hood during Direct Flame cooks may result in an ER-1 error message. This error message means that the grill has reached too high of a temperature causing the grill to shut down, avoiding any damage to the grill.
- Never leave your grill unattended during a direct flame cook.



Follow the guidelines listed below to prevent carbon monoxide poisoning.

Know the symptoms of carbon monoxide poisoning: headache, dizziness, weakness, nausea, vomiting, sleepiness, and confusion. Carbon monoxide reduces the blood's ability to carry oxygen. Low blood oxygen levels can result in loss of consciousness and even death. See a doctor if you or others develop cold or flu-like symptoms while cooking or in the vicinity of this appliance. Carbon monoxide poisoning, which can easily be mistaken for a cold or flu, is often detected too late.

Alcohol consumption and drug use increase the effects of carbon monoxide poisoning.

Carbon monoxide is especially toxic to mother and child during pregnancy, infants, the elderly, smokers, and people with blood or circulatory system problems, such as anemia, or heart disease.





AVERTISSEMENT GÉNÉRAL: LIRE TOUTES LES CONSIGNES DE SÉCURITÉ AVANT D'UTILISER LE GRIL

- S'IL VOUS PLAÎT LIRE CE MANUEL EN ENTIER AVANT L'INSTALLATION ET L'UTILISATION DE CE WOOD PELLET À COMBUSTIBLE APPAREIL. NE PAS SUIVRE LES INSTRUCTIONS PEUT PROVOQUER DES DÉGÂTS MATÉRIELS, DES BLESSURES OU MÊME LA MORT.
- CET APPAREIL N'EST PAS DESTINÉ À ÊTRE UTILISÉ PAR DES PERSONNES (Y COMPRIS DES ENFANTS) AYANT DES CAPACITÉS PHYSIQUES, SENSORIELLES OU MENTALES RÉDUITES, OU UN MANQUE D'EXPÉRIENCE ET DE CONNAISSANCES, À MOINS QU'ELLES N'AIENT REÇU UNE SUPERVISION OU DES INSTRUCTIONS CONCERNANT L'UTILISATION DE L'APPAREIL PAR UNE PERSONNE RESPONSABLE DE LEUR SÉCURITÉ.
- LES ENFANTS DOIVENT ÊTRE SURVEILLÉS POUR S'ASSURER QU'ILS NE JOINT PAS AVEC L'APPAREIL.
- CONTACTEZ LE SERVICE DES SERVICES D'INCENDIE SUJET DES EXIGENCES D'INSPECTION D'INSTALLATION DANS VOTRE RÉGION.
- CONSERVER CES INSTRUCTIONS.
- POUR L'UTILISATION EXTÉRIEURE SEULEMENT. NE PAS UTILISER DANS UN ENDROIT CLOS. .
- GARDEZ LE GRIL 30 "(76CM) OU PLUS DE TOUTE SURFACE COMBUSTIBLE.
- POUR PRÉVENIR LES INCENDIES DE GRAISSE, NETTOYER LE GRIL RÉGULIÈREMENT, Y COMPRIS LES SAORIZERS® ET LE PLATEAU DE GRAISSE. NE METTRE RIEN D'INFLAMMABLE DANS LA ZONE DE STOCKAGE SOUS LE GRIL
NE PAS LAISSER DES RÉCIPIENTS DE NOURRITURE SCELLÉS SUR OU PRÈS DU GRIL.
CONSERVER LES CRÉNEAUX DE VENTILATION ARRIÈRE DE THE GRILL DÉGAGÉE DE TOUT OBSTACLE.
IL EST RECOMMANDÉ QUE VOUS VÉRIFIEZ RÉGULIÈREMENT VOTRE GRIL POUR DES OBSTRUCTIONS POT DE COMBUSTION POUR ASSURER QU'UN FLUX D'AIR APPROPRIÉE EST MAINTENU. VOIR ENTRETIEN DU GRIL DANS CE MANUEL POUR LES PROCÉDURES CORRECTES .
LES PARTIES ACCESSIBLES DES GRILL SONT TRÈS CHAUDS. ELOIGNEZ LES JEUNES ENFANTS PENDANT SON UTILISATION.
EXERCER UNE DILIGENCE RAISONNABLE LORSQUE VOUS UTILISEZ VOTRE GRIL. EN PRÉSENCE D'ENFANTS, UN ADULTE EST CONSEILLÉE .
NE PAS UTILISER NI DES PIERRES DE LAVE NI DE CHARBON DE BOIS DANS VOTRE GRIL. .



SI UN FEU DE GRAISSE SE PRODUISAIT, ÉTEIGNEZ LE GRILL, RETIREZ LES ALIMENTS (UTILISEZ VOTRE JUGEMENT), ET DE LAISSER LE CAPOT FERMÉ AVANT QUE LE FEU SOIT ÉTEINT. NE DÉBRANCHEZ PAS LE GRILL SAUF SI ABSOLUMENT NÉCESSAIRE; VENTILATEURS CONTINUENT À FONCTIONNER JUSQU'À CE QUE LE FEU EST ÉTEINT. LORSQUE LA CUISSON FOODS EXCEPTIONNELLEMENT GRAS, METTEZ UN PAN DE FEUILLE DESSOUS DES ALIMENTS POUR ATTRAPER LE GRAISSE.

N'UTILISEZ JAMAIS D'ESSENCE, DE TYPE ESSENCE LAMPE, DE KÉROSÈNE, DE LIQUIDES ALLUME OU DE LIQUIDE SIMILAIRE POUR DÉMARRER OU RAFFRAÎCHIR UN FEU DANS CET APPAREIL. GARDER CES LIQUIDES LOIN DE L'APPAREIL EN COURS D'UTILISATION.

LES CENDRES DOIVENT ÊTRE PLACÉES DANS UN CONTENANT MÉTALLIQUE AVEC UN COUVERCLE HERMÉTIQUE. L'CONTENANT FERMÉ DEVRAIT ÊTRE PLACÉ SUR UNE SURFACE NON COMBUSTIBLE, LOIN DE TOUS MATÉRIEAUX COMBUSTIBLES, EN ATTENDANT L'ÉLIMINATION FINALE. QUAND LES CENDRES SONT DESTINÉES À ÊTRE ENTERRÉES DANS LE SOL OU DISPERSÉES AUTREMENT SUR PLACE, ELLES DEVRAIENT ÊTRE GARDÉES DANS LE CONTENANT FERMÉ JUSQU'À CE QU'ELLES SOIENT COMPLÈTEMENT REFROIDIES. POUR ÉVITER LES RISQUES DE DES BRÛLURES GRAVES, NE PAS SE PENCHER SUR UN GRIL OU PLACER LES MAINS OU DOIGTS OUVERTS SUR LE BORD AVANT DE LA BOÎTE DE CUISSON.

NE PAS UTILISER D'ACCESSOIRES NON SPÉCIFIÉS AUX PRISES DE CET APPAREIL.

LE GRIL DOIT ÊTRE BRANCHÉ SUR UN DDFT (DISJONCTEUR DE FUIE À LA TERRE). PRISE GFCI.

LORSQU'IL N'EST PAS EN SERVICE LE GRIL DOIT ÊTRE DÉBRANCHÉ .

LE GRIL DOIT RESTER BRANCHÉ SUR UN DDFT DURANT LE CYCLE DE REFROIDAGE .

METTRE DES GANTS BARBECUE THERMORÉSISTANTS POUR UTILISER L'APPAREIL .

NE PAS DÉPLACER OU NETTOYER VOTRE GRIL PENDANT LE FONCTIONNEMENT OU LORSQUE LE GRIL EST CHAUD. S'ASSURER QUE LE FEU EST COMPLÈTEMENT ÉTEINT, ET QUE LE GRIL A COMPLÈTEMENT REFROIDI AVANT DE TRANSPORTER OU NETTOYER LE GRIL .

SI LE FIL ÉLECTRIQUE EST ENDOMMAGÉ, NE PAS UTILISER LE GRIL.

SI LE CÂBLE D'ALIMENTATION EST ENDOMMAGÉ, IL DOIT ÊTRE REMPLACÉ PAR LE FABRICANT, SON AGENT DE SERVICE OU DES PERSONNES QUALIFIÉES AFIN D'ÉVITER TOUT DANGER.

NE PAS UTILISER NI D'AÉROSOLS, NI DE LIQUIDES, NI DES MATÉRIEAUX HUMIDES SUR OU PRÈS DU GRIL PENDANT QU'IL EST CHAUD.

NE PAS COUVRIR L'INTÉGRALITÉ DE LA SURFACE DE CUISSON LORSQUE LE GRIL EST CHAUD. LAISSEZ AU MOINS 2 POUÇES DE DÉGAGEMENT PAR LES CÔTÉS ET L'ARRIÈRE DU CORPS DU GRIL .

TOUTE MODIFICATION (TROUS, VIS, CHANGEMENTS DE MÉTAL) AU GRIL ANNULERA LA GARANTIE.

TOUJOURS UTILISER LE GRIL AVEC LE CAPOT DU GRIL EN POSITION FERMÉE, SAUF SI LE GRIL EST DANS UN MODE DE FLAMME DIRECTE.

NE JAMAIS UTILISER LE GRIL DANS UN MODE DE FLAMME DIRECTE SANS METTRE L'INSERTION DE SAORIZER® DE FLAMME DIRECTE (VG4407). L'EZ-ACCESS OU INSERTION DE FLAMME DIRECTE DOIT ÊTRE EN PLACE PENDANT LE FONCTIONNEMENT .

LA CUISSON À FLAMME DIRECTE DOIT ÊTRE EFFECTUÉE AVEC LE CAPOT EN POSITION OUVERTE. UN CAPOT FERMÉ PENDANT LA CUISSON À FLAMME DIRECTE PEUT ENTRAÎNER UNE ER-1 MESSAGE D'ERREUR. CE MESSAGE D'ERREUR SIGNIFIE QUE LE GRIL A ATTEINT UNE TEMPÉRATURE TROP ÉLEVÉ QUI A PROVOQUÉ LE GRIL D'ARRÊTER POUR ÉVITER TOUT DOMMAGE À L'UNITÉ.

NE JAMAIS LAISSER LE GRIL SANS SURVEILLANCE PENDANT UNE CUISSON À FLAMME DIRECTE .

SUIVEZ LES INSTRUCTIONS CI-DESSOUS POUR EMPÊCHER L'INTOXICATION AU MONOXYDE DE CARBONE .

CONNAÎTRE LES SYMPTÔMES DE L'INTOXICATION AU MONOXYDE DE CARBONE: MAUX DE TÊTE, VERTIGES, FAIBLESSE, NAUSÉES, VOMISSEMENTS, SOMNOLENCE ET CONFUSION. LE MONOXYDE DE CARBONE RÉDUIT LA CAPACITÉ DU SANG À TRANSPORTER L'OXYGÈNE. LES FAIBLESSES AU NIVEAU D'OXYGÈNE DANS LE SANG PEUT ENTRAÎNER UNE PERTE DE CONNAISSANCE ET LA MORT. CONSULTEZ UN MÉDECIN SI VOUS OU LES AUTRES DÉVELOPPENT DES SYMPTÔMES D'UN RHUME OU PSEUDO-GRIPPAUX PENDANT LA CUISSON OU DANS LES ENVIRONS DE CET APPAREIL. L'INTOXICATION AU MONOXYDE DE CARBONE, QUI PEUT FACILEMENT ÊTRE CONFONDU AVEC UN RHUME OU UNE GRIPPE, EST SOUVENT DÉTECTÉE TROP TARD. LA CONSOMMATION D'ALCOOL ET L'USAGE DE DROGUES AUGMENTENT LES EFFETS DE L'INTOXICATION AU MONOXYDE DE CARBONE. LE MONOXYDE DE CARBONE EST PARTICULIÈREMENT TOXIQUE POUR LA MÈRE ET L'ENFANT PENDANT LA GROSSESSE, LES NOURRISSONS, LES PERSONNES ÂGÉES, LES FUMEURS ET LES

GENS AVEC LES PROBLÈMES DU SANG OU DU SYSTÈME CIRCULATOIRE COMME L'ANÉMIE, OU UNE MALADIE CARDIAQUE .





How Your Memphis Grill Works

Your Memphis Wood Fire Grill represents a new way of outdoor cooking. It is a true high-quality convection oven that also has grilling and smoking capability. It combines many unique features with time-proven pellet burning technology. Together they give you controlled, quick, savory, and repeatable cooking results. The perfect cooking experience starts with filling your hopper with all-natural, 100% certified hardwood BBQ pellets; we recommend “Memphis” flavored BBQ pellets.

Simply tapping the “Initiate Startup Sequence” Button will fully ignite your grill. The grill will reach your desired temperature within minutes of ignition. The ITC convection system and automatic auger feeds the wood pellets from the hopper into the burn pot, where the ignitor has direct contact with the pellets. The Intelligent Temperature Control allows you to set the cooking method and desired temperature, and will adjust for ambient conditions. The convection/circulation blower provide combustion air to the burn pot and convective cooking air by distributing the heat evenly throughout the cooking area. The natural smoke flavor produced by the burning pellets, the vapor produced by the juices dripping on the Savorizer®, and the air circulating throughout the cooking area, combine to give you the unique flavor that can only be achieved using a Memphis Wood Fire Convection Grill.

A video explaining this procedure is available on our website and YouTube® channel

Grill Features

- Easy to use Intelligent Temperature Control (ITC) capable of smoking, barbecuing, grilling, baking and searing temperatures.
- Memphis ITC Meat Probe functionality for hands-off, precision grilling
- Extra-large capacity hopper
- Heavy-duty stainless steel construction
- Cooking area is double wall (insulated) and dual-wall oven gasket sealed for maximum heat retention
- Attractive craftsmanship and high-quality performance
- High CFM blower causes pellets to burn and produce true convection oven cooking. Auto Start button & electric igniter eliminate the need for matches & lighter fluids
- Smoke Mode gives you that savory flavor on demand and is programmable from 180°—295°F
- Cook Mode allows for grill temperatures up to 550°F (Beale Street), 650°F (Pro), and 700°F (Elite)
- Savorizer® reduces the chance of flare-ups and assists in even heat distribution. (DO NOT COVER WITH FOIL, THIS WILL REDUCE AIR FLOW)
- EZ-Access Savorizer® Insert for quick and easy burn pot cleaning
- Stainless steel burn pot designed for high performance and longevity
- Ability to increase the cooking area with optional cooking grates (See website for specific details.)
- Up to 6,354 cubic inches of cooking area depending on model
- Grease drawers with disposable pans for no fuss cleaning
- Large, locking casters that swivel and lock for easy maneuverability
- Two stainless steel side shelves offer a durable, easy-to-clean surface
- Stainless steel cooking grates for years of reliable use
- Designed, engineered and tested in the USA
- Meat probe is standard with Elite and Pro Memphis models; additional meat probes can be purchased separately



Built-In Installation

Dedicated Electrical Circuit with GFCI Protected Outlet

A dedicated GFCI protected electrical circuit is REQUIRED for all Memphis Wood Fire Grills and controller systems. This circuit should be installed by a Certified Electrician. Although the Memphis Grill only uses about 2 amps of current during startup, any other equipment (refrigerator, pool pump, fountains, etc.) that have high current draw, consistently or intermittently, from the same electrical circuit can cause potential issues and/ or interruptions with the performance of the grill. We recommend an on/off switch to be installed in this circuit so that the grill can be easily disconnected from power when not in operation. This will prevent the buildup of interference that could affect the controller's operation.



Read Prior to Lighting

Initial Burn Off

Before cooking for the first time, we recommend that you “burn off” the grill to rid it of any foreign matter used in the manufacturing process. Prior to burn-off, completely remove the plastic film on all stainless steel surfaces. Failure to do so will cause the film to melt to the metal, and it will be extremely difficult to remove. Remove the cooking grates and wash with a mild soap or detergent. Replace the grates, light and operate the grill at 450°F with the hood down for 45 minutes. After burn-off, you are now ready to start enjoying your Memphis Wood Fire Grill!

Lighting Your Grill

It is recommended practice to go through the [Periodic Grill Maintenance](#) (pg. 27) procedures frequently. This will ensure proper ignition of the pellets and is part of the normal maintenance procedure. Light per instructions found in detail in this manual. If the grill fails to light, it is most likely due to a dirty or plugged ignitor and/or a burn pot obstruction blocking the igniter air passages. (Refer to [Using Your Memphis Wood Fire Grill](#) on page 19 for cleaning instructions.)

Hood Position

Always cook with the hood CLOSED when not using the Direct Flame insert. Cooking with the hood closed keeps the temperature even, cooking the food faster while using less fuel. If the hood is left open for an extended period of time, it will cause the ITC to increase the fuel feed rate in an effort to increase the grill temperature. This could result in pellets overloading the burn pot.

Instead of frequent, visual checks of your food, the use of a Memphis ITC Meat Probe is recommended. This tool can be routed through the larger hole in the side of the Memphis Pro or Elite to prevent damage to the wires. See “Memphis ITC Meat Probe” on page 20 for further instructions on the use of a meat probe.

When using the Direct Flame mode, the hood should be closed during ignition and warm-up, with the Indirect Insert placed in the Savorizer®. Once the grill is at 400°F, the EZ-Access Indirect Insert can be replaced with the Direct Flame Insert and the grill mode can be set to Direct Flame Mode, where the lid must be left open for the duration of the cook.



Display Operation Instructions

About The ITC 3

The ITC performs similarly to the control on your kitchen oven. The ITC automatically compensates for different conditions, providing year-round grilling and more accurate temperature control. Setting the control is simple and intuitive, and offers the user a precise and highly customizable grilling experience.

1 Temperature Units

- Shows what temperature units are currently being used (Fahrenheit or Celsius)

2 Wi-Fi

- Connection strength is displayed in the top right and will show a red X when there is no connection.



4 Push Button

- This can be used to set the grill into cooldown, put the display to sleep, and resetting the controller.

5 Initiate Startup Sequence

- This bar allows the user to navigate to the Dashboard, Grill Settings, History, Routines, and Settings screens.

3 Nav Bar

- This bar allows the user to navigate to the Dashboard, Grill Settings, History, Routines, and Settings screens.



Splashscreen

- 1 Start Grilling!**
 - Tap to enter the main menu of the controller.

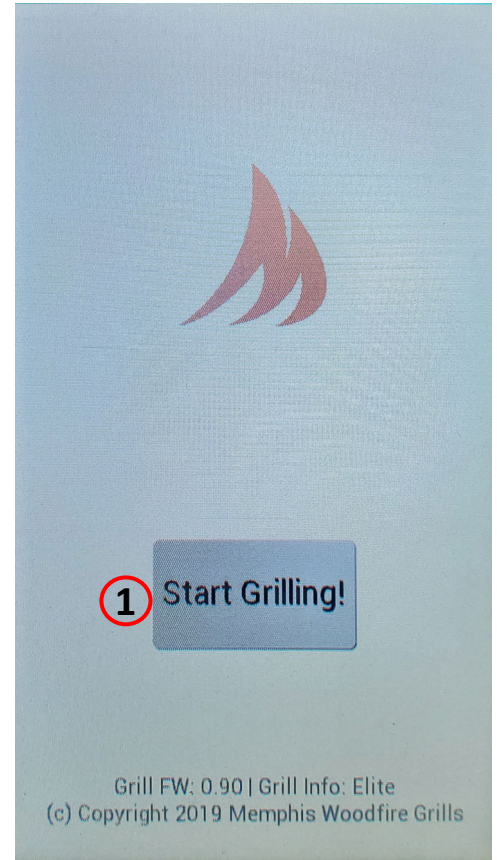

Dashboard

- 2 Grill Temperature**
 - Displays current grill temperature and the set temperature.
- 3 Cook Light Button**
 - Used to turn on and off the cook lights.
- 4 Meat Probes**
 - The probes will display as "OFF" until a probe has been plugged into the grill.
 - Once plugged in, the current probe temp and the set temp will be displayed here.
- 5 Routine/ Error Status**
 - Displays selected routine and the current routine step.
 - Active error codes and short descriptions.
- 6 Runtime**
 - Displays how long the grill has been running.
- 7 Grill Status**
 - Current status of the grill.
 - Statuses include: Off, Cold Start, Low Smoke Temp, High Smoke Temp, Cook, and Direct Flame.
- 8 OFF Button**
 - Set Grill to Cooldown or turn off the display

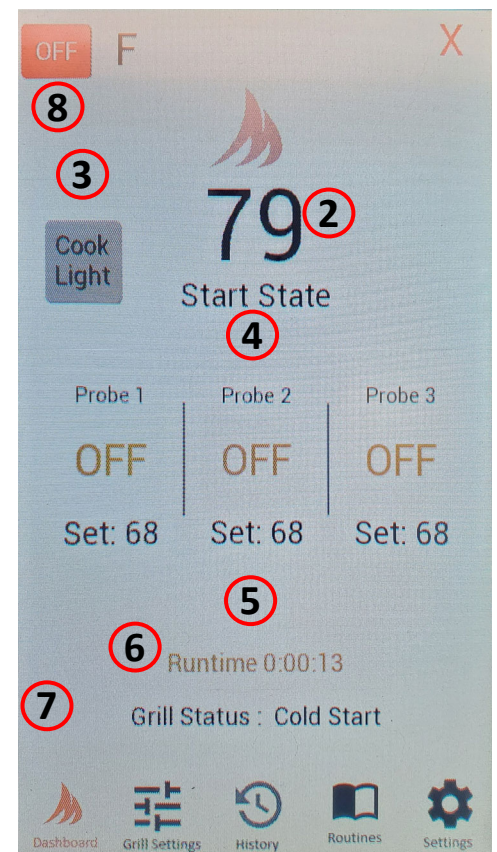



Cooldown Screen

1 Start Cooldown

- Change grill status to Cooldown.
- If grill is in Cooldown, this button can be used to cancel Cooldown and resume grilling.
- To navigate to this page, press the OFF button in the top left. This button is only available after the grill has been started.

2 Screen Off

- Sets screen to sleep.

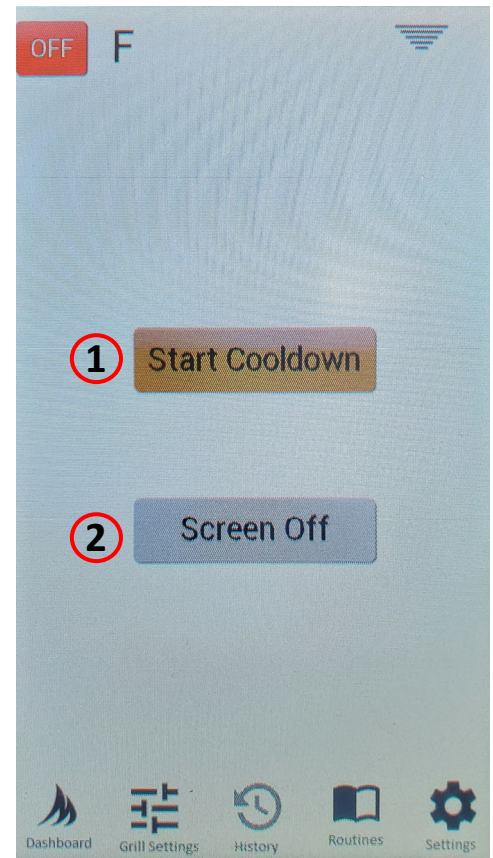

Grill Settings

3 Grill Set Temperature

- Select the set temperature using the slider or the +/- buttons. Set temperature in increments of 5.

4 Cook Mode

- Use the Cook Mode to select between Indirect Flame and Direct Flame.

5 Meat Probe Settings

- Sub-menu for setting the Meat Probe set Temperatures and other probe settings.

6 Timer

- User can set a timer that will prompt an alarm on the grill.
- Increase the hour and minutes timer by pressing the +/- buttons and selecting the "H" or "M" buttons.

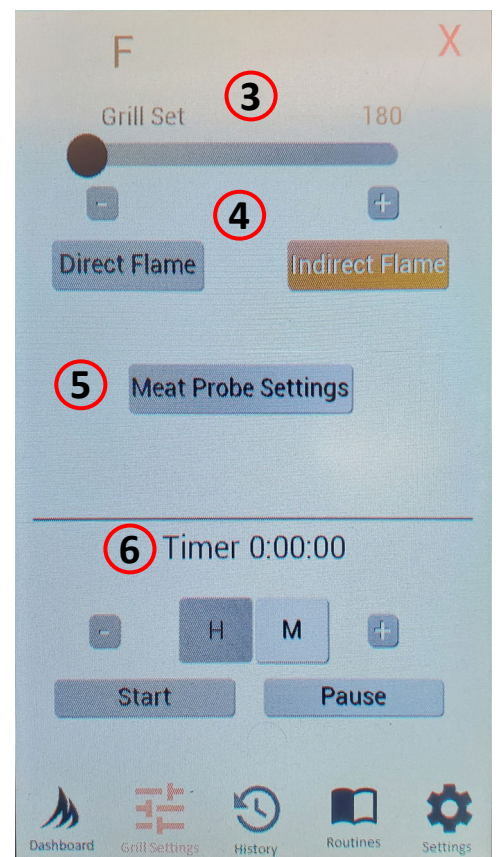



Grill Settings– Continued

1 Direct Flame Select

- Select the flame level from Low, Med, and Xtreme.

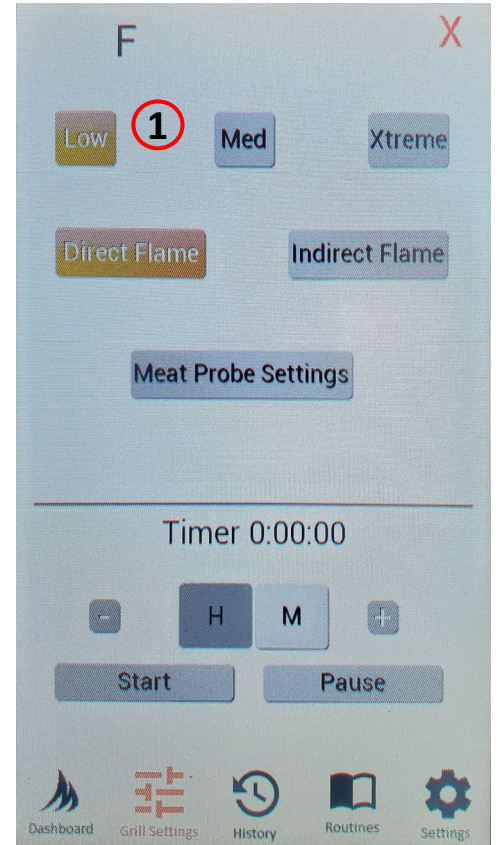

Meat Probe Settings

2 Probe Set Temperature

- Select the probe set temperature using the slider or the +/- buttons. Set temperature can be set from 68 to 250 degrees F.

3 Probe Alarm

- User can turn on/off the alarm when a probe reaches temperature.

4 Warm Mode

- User can turn on/off if the grill changes set temp to 180 when a probe reaches temperature.

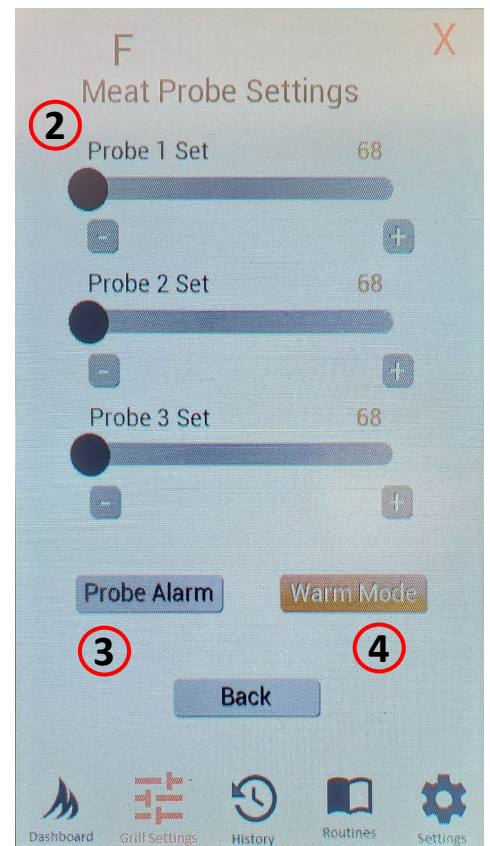



History Screen

1 Probe History

- Probe 1 temperatures displayed in red, Probe 2 temperatures displayed in orange, and Probe 3 temperatures displayed in blue.

2 Display Temperature Points

- Probe temperatures are displayed here over time, as more temperature points are recorded the graph is shifted.

3 Navigation Buttons

- Navigate through the recorded temperatures using these buttons.

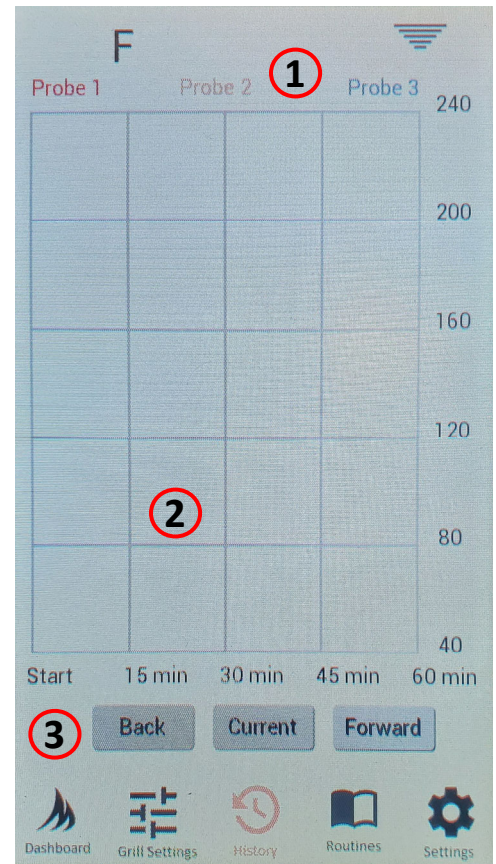

Grilling Routines

4 Selected Routine

- The current routine that is selected is displayed here.

5 Routine Menu

- Navigate to the sub-menu of available routines for the type of cook you are planning for.

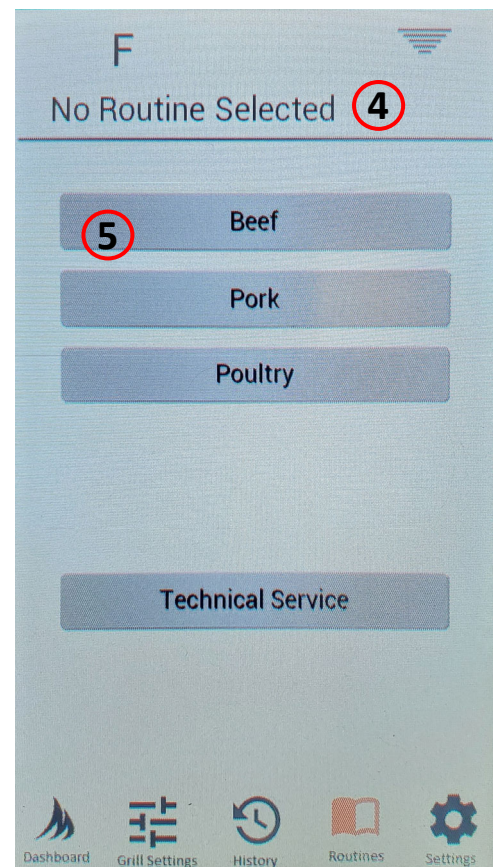



Routine Sub-Screen

- 1 Routine Selection**
 - Select the routine that you would like to view.
- 2 Back Button**
 - Navigate back to the main routine menu.

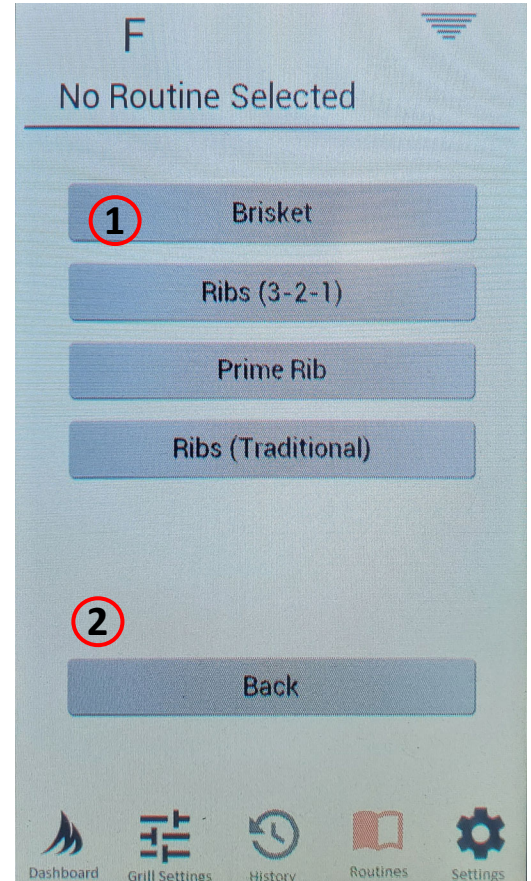

Routines Events

- 3 Routine Info**
 - Routine name and the initial grill set temp is displayed.
- 4 Routine Steps**
 - Displays the routine event type (Probe or Timer), the event value, as well as an event description.
- 5 Scroll Bar**
 - Use this to scroll through the routine steps.
- 6 Back Button**
 - Back out of a specific routine to select a different routine.

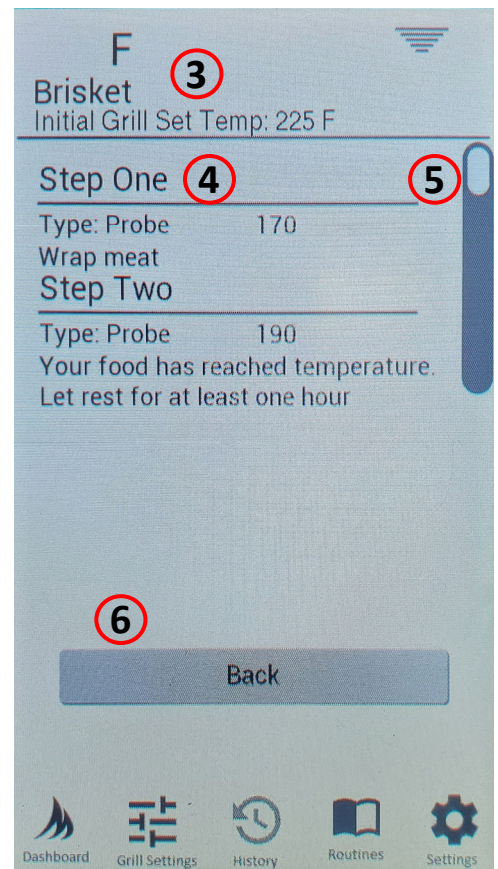



Settings

- 1 Pellet Prime**
 - With the grill in Off or Start mode, hold the pellet prime button to turn on the auger to prime before attempting ignition.
- 2 Temperature Units**
 - Press the toggle to switch between Fahrenheit and Celsius.
 - The current Temp unit selected is also shown in the top left of the screen.
- 3 Screen Brightness**
 - Use the slider to change the screen brightness.
- 4 Wifi Sub-menu**
 - Use to navigate to the WiFi sub-menu.
- 5 OTA Update Sub-menu**
 - Use to navigate to the OTA Update sub-menu.
- 6 Diagnostics Sub-menu**
 - Use to navigate to the Diagnostic sub-menu.

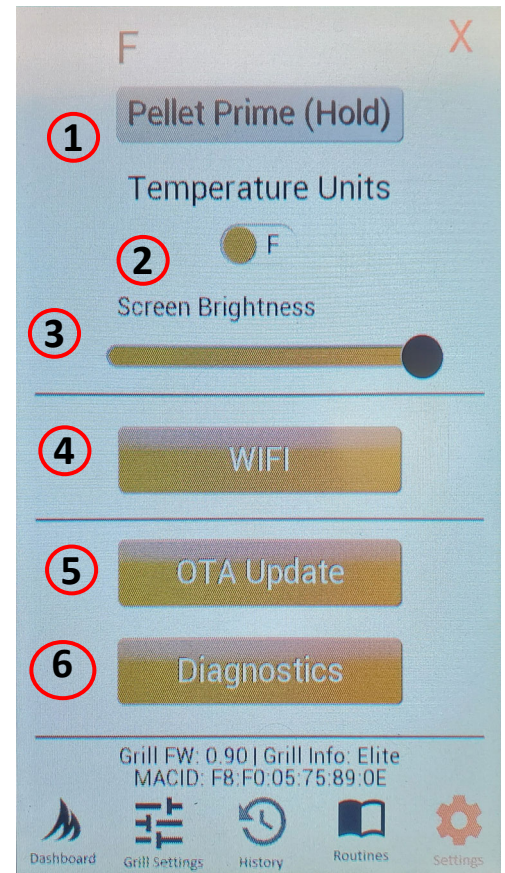

WiFi Connection– Not Connected

- 7 WiFi Connect**
 - Use this button to provision the grill via the Memphis 3 App.
- 8 WiFi Status**
 - Displays current connection status of grill.
- 9 WiFi Firmware Version**
 - Displays the current WiFi Firmware running on the grill.

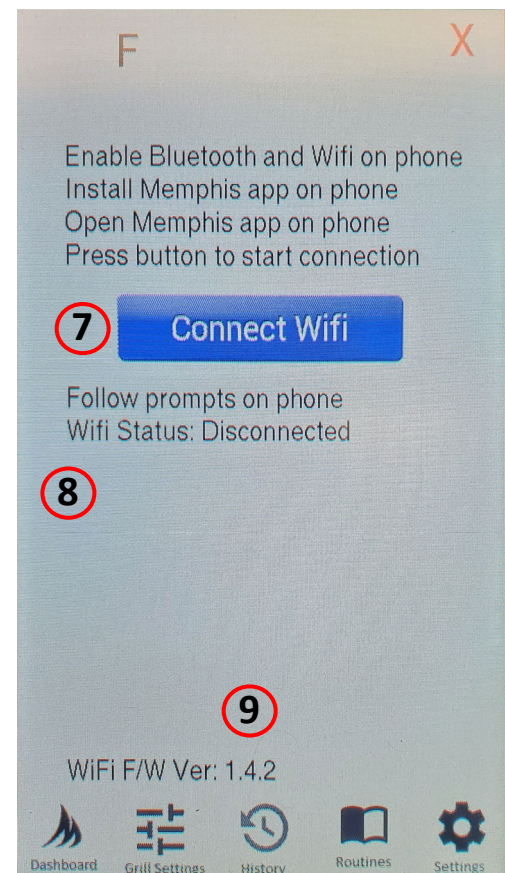



WiFi Connection– Network Connection

- 1 Network Info**
 - Network name, signal strength, and the connection status is shown here.
- 2 Grill Info**
 - The grill name, MAC address, and IP address are shown here.
- 3 Reset Connection**
 - Press “Reset Connection” to have the grill forget the provisioned network credentials.

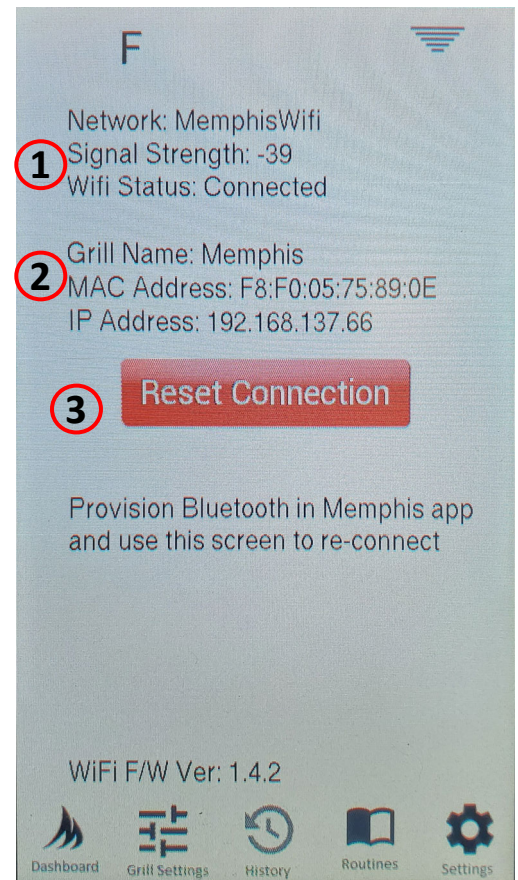

WiFi Connection– Reset Connection

- 4 Grill Restarting**
 - Device is working to disconnect from the current network.

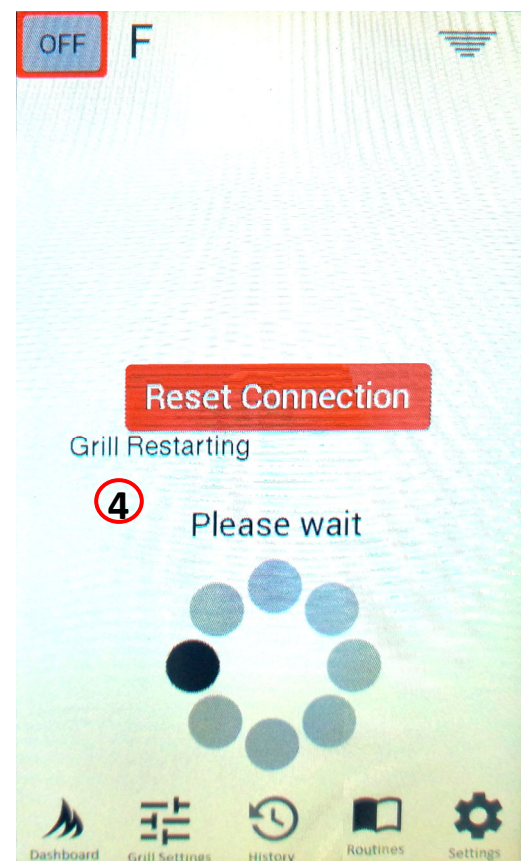



OTA Update– Initiate Download

1 Download

- Initiate download of the OTA (Over-The-Air) Update.
- Check Memphis Grills website for the most current firmware available.
- Progress bar shows how much of the update has been downloaded.

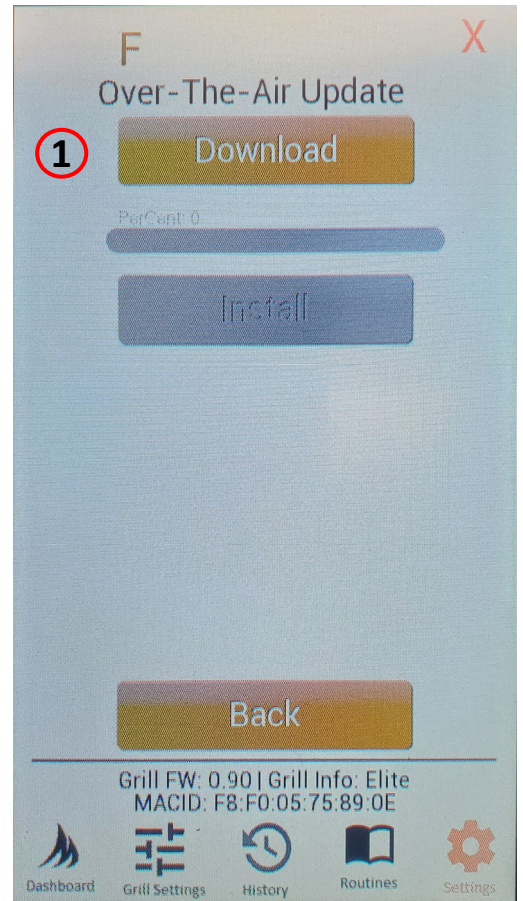

OTA Update– Download In Progress

2 Cancel Download

- Once download has started, this button is able to cancel the download before it has completed.

3 Progress Bar

- The percentage of the update currently downloaded is shown here.

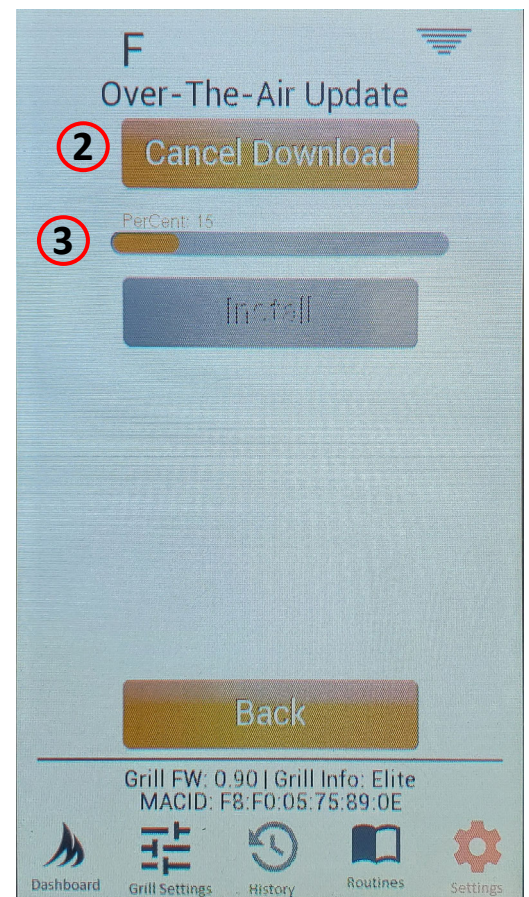



OTA Update– Download Complete

- 1 Download Completed**
 - Progress bar shown at 100% once the update has completely downloaded.
- 2 Install (Reboot)**
 - Install button will be available once the update download has been completed.
 - Use this button to initiate the installation of the update.
 - Controller will restart after a brief period.

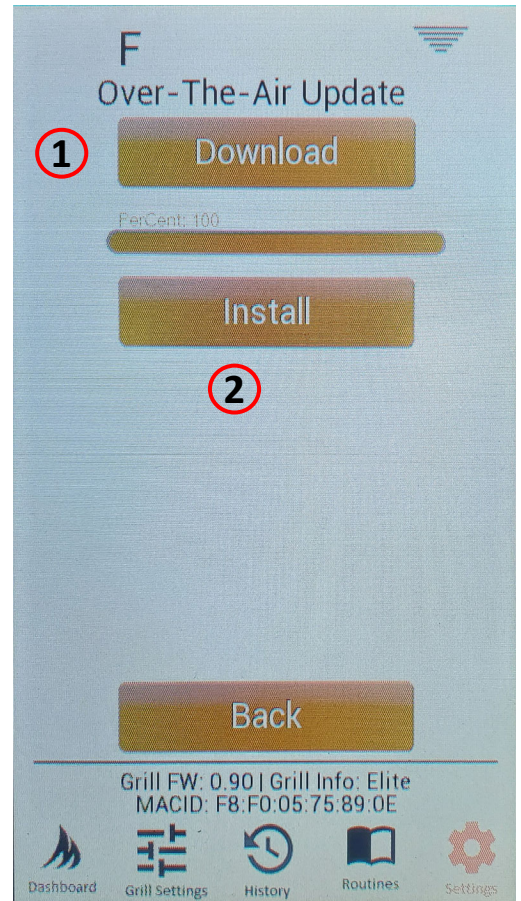

Diagnostics

- 3 Full Test**
 - Runs a complete test of all the components within the grill.
- 4 On/Off Toggles**
 - Allows user to test a specific component or retest a component that failed during the initial full test.
- 5 Pass/ Fail Buttons**
 - Some components need the user to verify if they've passed or failed the test.

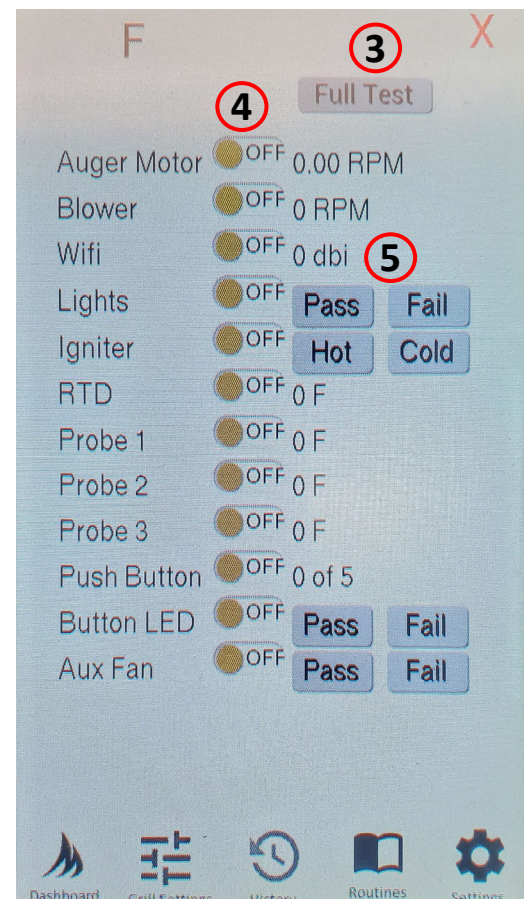



MEMPHIS WI-FI SETUP GUIDE

ON YOUR MEMPHIS GRILL:

1. Register your account in the Memphis 3 app before proceeding.
2. Navigate to the Settings Screen (far right icon) on the Memphis Grill.
3. Press "WiFi" to navigate to the Connection Screen.
4. Press "Connect WiFi" to start WiFi setup. The screen will display "Visible on Bluetooth" to show it has started.
5. Follow the steps below on your Memphis 3 App.

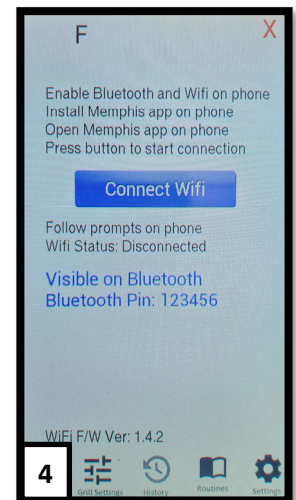
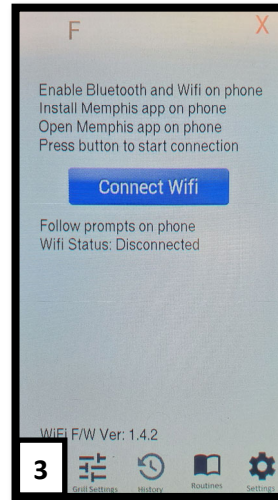

ON YOUR PHONE OR TABLET: (In Memphis 3 App)

6. Log into Memphis 3 App using your account email and password.
7. If this is your first time setting up a grill on the app, a window will pop up asking to "Provision Grill" or "Add Existing". Press "Provision Grill".
 - 7a. If this isn't the first grill being added to your account, select the settings gear in the top right corner and press "Add Grill" to get the popup.
8. Select your home WiFi network from the scan list shown, enter the WiFi password, and press "Provision".
 - 8a. The WiFi network must be a 2.4 GHz network to appear on the list
9. Enter the Bluetooth Pin to complete provisioning.
10. Once the connection is complete the Memphis Grill will display "Connection Successful" and update in WiFi screen information. The WiFi connection bars will also be displayed in the top right corner.
11. After the WiFi is connected, a popup window will appear in the Memphis 3 app asking for the MAC address and Grill Name. This information can be found on the WiFi screen of the Memphis Grill. Press Settings Menu (Bottom right icon) -> WiFi-> WiFi screen.

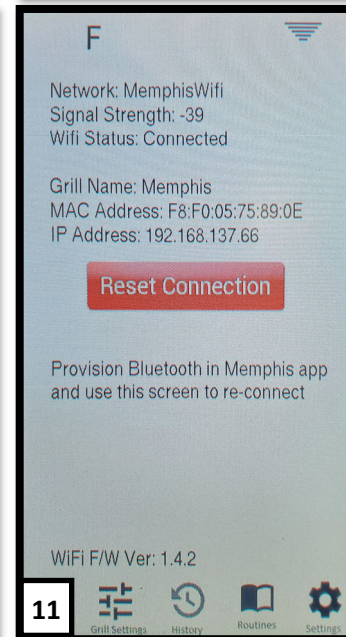
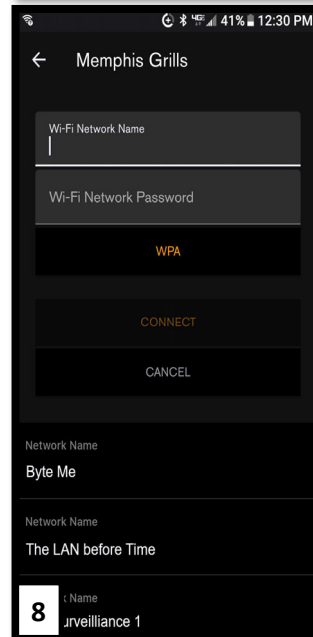
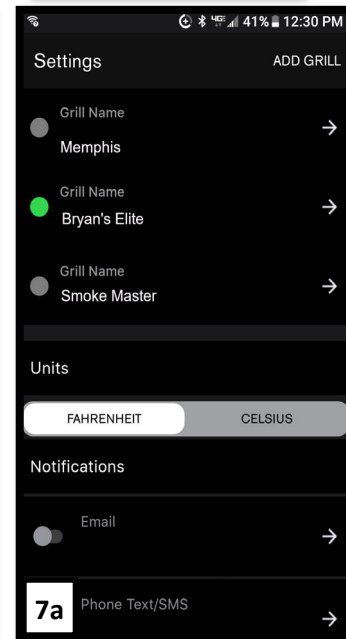
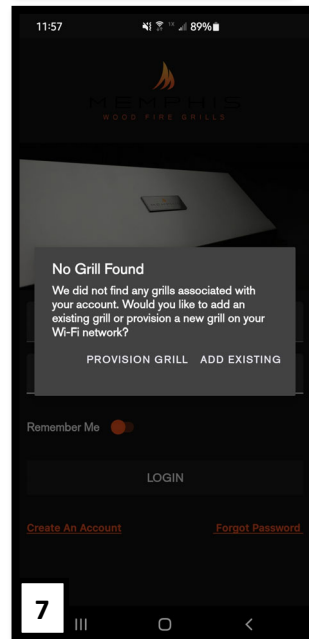

*Contact Memphis Technical Support if unable to connect.



Using Your Memphis Wood Fire Grill

Prior to starting the grill, inspect the burn pot inside the grill for excess ash build-up. It's a recommended practice to go through this procedure at initial startup and after every few uses to ensure peak performance. Actual necessary frequency varies depending on usage and pellet brand. (Pellets other than Memphis can cause excess ash.)

Recommended Regular Inspection/Cleaning

1. Unplug the grill from the electrical outlet.
2. Open the hood and remove the cooking grates.
3. Remove the Savorizer® or EZ-Access Indirect Insert. The Savorizer® helps distribute heat, contain fly ash, and keeps the flame from making direct contact with cooking grids.
4. Check the burn pot area; remove any foreign items to ensure that the air holes in the burn pot are clear. This will allow a quicker and more efficient ignition. Take precautions not to damage the igniter wiring connections or pull the igniter out of the igniter harness.
5. Re-install the Savorizer®/EZ-Access Insert.
6. Re-install the cooking grates.
7. Check the grease pans and clean as necessary.
8. Open the pellet hopper lid, found at the back. Check for any wet pellets or debris.
9. Fill your hopper with an equal amount of Memphis cooking pellets on both sides. Close the hopper lid.
10. Plug your Memphis wood fire convection grill into the nearest 110 volt AC Outlet.* Note: See page on circuit recommendations.
11. When you are finished using our grill and the grill has gone through its cooldown, unplug it. It is also recommended that the grill be covered when not in use.

*230 Volt for European

Note: Your grill will function best if operated on a level surface.



Operating Instructions: Memphis Wood Fire Grill

Automatic Startup

To start, press the “Initiate Startup Sequence” button on the Dashboard screen of display. The startup mode will begin; pellets will begin falling into the burn pot and the igniter heats up. The startup mode is timed to last 25 minutes or until the appliance reaches a temperature above 165°F.

On the Grill Settings screen, use the slider or +/- buttons to set grill temp. If the grill is set to a temperature less than 300° it will run in Smoke Mode. If set to 300° or above it will run in Cook Mode. The Meat Probe can be set from 68° to 250°. For more information on the use of the Meat Probe, consult pages 11 & 22.

Notes

- Your grill will smoke for a few minutes while the pellets are lighting and coming to a full ignition. This typically takes 3-4 minutes to occur.
- If the startup temperature of 165°F is not reached within 25 minutes, the grill will then automatically shut off, and an alarm will sound. If this happens, some unburned pellets will have built up in the burn pot. Before restarting the fire, clean the excess pellets out of the burn pot and repeat the above steps.

Change Temperature Display Units

Your Memphis grill is capable of working in both Metric and English units. You can change display units using either the grill display or the App. A change on one is automatically made to the display of the other.

To switch between Fahrenheit and Celsius on the ITC, navigate to the Setting Screen and select the F/C switch. Selected units automatically save for future cooks. See page 14 Settings screen.

To switch between Fahrenheit and Celsius on the App, navigate to the “Settings” gear (Top Right) and select the desired units.



Operating Instructions: Memphis Wood Fire Grill

Once the Memphis Grill has started, operate as follows:

Pre-Heat

This is the beginning stage of cooking or smoking in which the fuel is ignited, and the grill is brought to the set temperature as quickly as possible. You may notice in this stage that, initially, the auger will feed fuel almost constantly. This is to prime the burn pot so that it is able to maintain significant heat. When this stage is concluded, the ITC will maintain selected cooking/smoking temperature, regardless of ambient weather conditions. The duration of this stage will vary somewhat due to differing ambient conditions, set temperatures, and grill models. In most cases, the grill will be in the pre-heat stage for 10 to 20 minutes.

Cooking Mode

Temperature will be automatically maintained at your temperature set point. You may notice some fluctuation up and down during this time. This is a normal part of any oven /convection appliance operation. The grill will automatically switch to this mode when the grill Set Temp is 300°F or higher.

Smoke Mode

Smoking is a variation on grilling and is one of the unique advantages of your Memphis Wood Fire Grill. The temperature you choose will largely depend on what is being smoked (see Page 30) and your personal preferences. The grill will automatically switch to this mode when the grill set temperature is 295° F or lower. Combustion airflow is varied in the smoke mode. You may hear the fan “bellow”, repeatedly turning on and off. This is normal operation.

Smoke Tip

To vary smoke flavor intensity, experiment with the amount of time you use the smoke mode and the mix of flavored pellets you use along with the all-purpose pellets. This is more important if you use stronger flavored pellets such as Mesquite. Starting in smoke mode allows the smoke to penetrate the meats before changing to sear sealing the flavor in. The smoke mode works best when a longer cooking time is required, such as large cuts of meat, fish, or poultry. Experiment with the length of time you allow for pre-smoking before cooking thoroughly. Try different combinations of both modes.

Searing/Direct Flame Cooking

One of the most unique features of your Memphis grill is the ability to truly sear in direct flame mode. Your Memphis grill comes standard with the Direct Flame Insert. Select “Direct Flame” at the top of the Grill Settings screen and choose the Low, Medium or Xtreme setting depending on grill and searing desire. Remove the grates and replace the Indirect Flame Insert with the Direct Flame Insert into the Savorizer®. Remember to always keep the hood open when operating your grill in the Direct Flame mode so as not to overheat the grill. The Direct Flame mode is ideal for putting the perfect sear on your meat or a nice char on peppers, corn or other vegetables. See page 22 for more details.



Memphis ITC Meat Probe

The Memphis ITC Meat Probe, which comes standard with the Elite & Pro Memphis models, is a must-have accessory for any griller. The ITC Meat Probe conveniently interfaces directly with your grill's ITC control and provides an easy way to ensure your food is cooked to your predetermined temperature. This feature ensures convenience and delicious, repeatable results—every time.

Caution!

When not in use DO NOT leave the meat probe inside the cooking chamber.

1. Plug the Meat Probe into one of three 3.5mm audio-style jacks, on the left side of the body of the grill, towards the back.
2. Turn the grill ON and set the grill temperature.
3. For each meat probe currently plugged into the ITC, the user can view the actual and set temperatures of the food on the Dashboard screen along with the grill temperature. The probe set temperature can be adjusted from 68°F to 250°F via the slider or +/- buttons on the Grill Settings screen.
4. Route the probe end through the probe gate in the grill's left side, just below the hood. The probe gate consists of a small sliding gate that can be moved up and down from the inside of the unit. Pull the desired amount of cable into the grilling area.
5. Insert the meat probe into the thickest portion of your meat item.
6. Sit back and relax.

The grill will cook the meat until the meat reaches the desired setpoint. The grill then automatically reduces to its lowest setting (180°F / 80°C for all models), and displays "Done". At any point during the cook, you can modify the set temperature of both the meat probe and the grill itself.

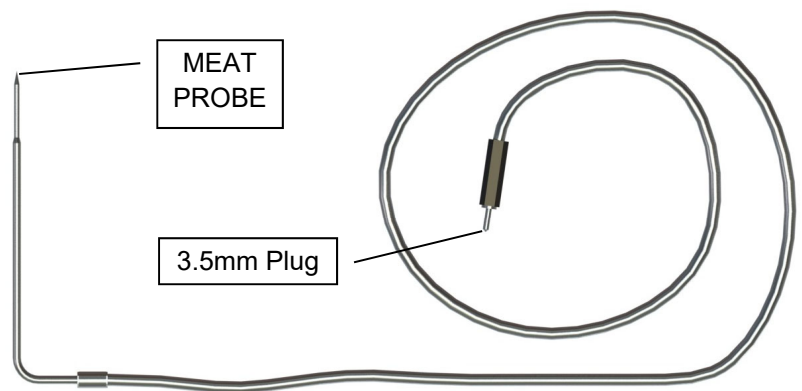

Meat Probe Care and Maintenance:

Keep the meat probe as clean and dry as possible. Clean with a damp sponge, or a cloth with a small amount of rubbing alcohol. If exposed to liquids for extended periods of time, the meat probe may display an erroneous reading. In extreme cases the ITC will constantly list the actual meat probe temperature as "32°F" or "0°C". To remedy this, allow the probe cord to dry completely before using it again. Once dry, this accessory may return to full functionality.

DO NOT submerge the meat probe when cleaning or place in dishwasher.



Memphis EZ-Access Savorizer®

The Memphis EZ-Access Savorizer® (A.K.A. "Indirect Insert"), which comes standard with all Memphis models, is your best friend when it comes to quick and easy cleaning of your grill's interior. This insert is located in the center of the Savorizer®, and is easily removed to allow access to the burn pot directly below.

Using Your Memphis EZ-Access Savorizer® Insert

1. Remove Grill Grates

The EZ-Access Insert is located just below the grill grates. Begin by opening the hood and moving the two most middle grates to the sides. This is made easier with the use of the Memphis Genie Tool (VG1595).

2. Remove the Insert.

The insert is not fastened, and can be easily removed using the Memphis Genie tool (standard on the Memphis Pro and Elite), a spatula, or a pair of tongs.

Note: Do not attempt to remove the insert or grates with your hands when the grill is hot.

3. Inspect and Clean the Burn Pot

With the insert removed, the burn pot is made directly accessible. Inspect it for excess ash build-up, and, if necessary pull out the burn pot insert and empty into ash drawer or non-combustible receptacle. It is especially important that the igniter air holes are free of ash for proper ignition and optimal performance.

4. Replace the EZ-Access Insert and Grill Grates

Once you're done cleaning the burn pot, replace the components you've removed. The EZ-Access insert should be fully seated in the Savorizer®, with its slopes matching the slopes in the Savorizer®. Replace the grill grates you moved in Step 1.

5. Cook Away!

Now that your burn pot is clean, it's time to grill!





Memphis Direct Flame Savorizer® Insert

The Memphis Direct Flame Savorizer® Insert is a must-have accessory for any griller. The Direct Flame Savorizer® Insert conveniently replaces the EZ-Access Indirect Insert, adding the flexibility to cook directly over a direct flame, while still managing grease flow. The Direct Flame Savorizer® Insert is available for all Memphis models.

Using Your Memphis Direct Flame Savorizer® Insert

1. Turn the grill on with the EZ-Access Indirect Insert in place, and the hood CLOSED. Let the grill preheat to a temperature of 400F° or greater.
2. Using the Memphis Genie Tool, remove the cooking grates and EZ-Access Indirect Insert from the Savorizer®.
3. Replace the EZ-Access Indirect Insert with the Direct Flame Savorizer® **Insert**.
4. Replace the cook grates and keep the grill hood OPEN for the remainder of the cook.
5. On the Grill Settings screen, select “Direct Flame” and chose the flame intensity by selecting Low, Medium, or Xtreme.
6. You are now properly in “DIRECT FLAME MODE”, leave the hood open and enjoy direct flame cooking!
7. When you are done cooking “DIRECT FLAME MODE” be sure to swap the Direct Flame Insert out for the Indirect Insert before your next cook. This can be done pre or post cool down cycle.

Notes

- While operating the grill in a direct flame setting the actual grill temperature will not be displayed, and the meat probe set temperature will be disabled. The meat probe will, however, display an actual meat temperature.
- Direct flame cooking should be performed with the hood in the open position. A closed hood during longer direct flame cooks may result in an ER-1 error message. This error message means that the grill has reached too high of a temperature causing the grill to shut down to avoid any damage to the unit.
- The grill is only to be operated in DIRECT FLAME MODE while cooking over a direct flame.
- The grill is never to be operated in DIRECT FLAME MODE without the optional Direct Flame Savorizer® Insert.
- Never leave your grill unattended during a direct flame cook.

In colder weather, it may be wise to allow the grill to warm up a bit longer before direct flame cooking.



Information about BBQ Cooking Pellets

- Flavored pellets come in a variety of flavors such as Apple, Cherry, Hickory, Pecan, Mesquite and Oak. They contain a mean heating value of 8,200 BTU's per pound and have very little ash and moisture content (less than 0.5% ash and less than 6% moisture). Always use premium BBQ pellets in your grill. Premium BBQ pellets have a maximum length of 1.5" and are uniform in size and shape. This shorter length and uniformity ensures a higher efficiency and a more consistent, even temperature. Premium pellets are made of certified 100% hardwood. Cooking with pellets made from soft woods, such as pine, should be avoided, as it yields a turpentine-like taste.
- Wood pellets have been in existence for many years, and there are currently more than 125 active pellet mill operations in the United States and Canada, producing millions of pounds of pellet each year.
- Memphis 100% hardwood BBQ pellets are produced in the same manner as wood pellet heating fuel is produced. Sawdust and clean wood chips are pulverized and dried. The dried material is then processed under heat and pressure. This material is forced through a hard steel die rotating against rollers with pressure over 3,000 PSI. Once the pellets are forced through the final die they are cooled, screened, vacuumed, and then bagged or boxed.
- No extra adhesives or bonding materials are used in the production of these pellets. Hardwoods contain naturally-occurring compounds called "lignins" that, when heated, act as a bonding material.
- Store pellets in a dry location for optimal performance. Flavor preference is an individual taste and we suggest you try different flavors or mixtures of flavors to find the combinations that suit your needs and tastes. (See your local dealer to order individual pellet flavors.)



Flavored Pellet Guidelines

- Apple: Sweet, fruity smoky flavor. Strongest of the fruit woods. Ideal for beef, pork, ham, poultry and wild game.
- Cherry: Mild, sweet fruity smoke flavor that gives a rosy tint to light meats. Ideal for beef, pork, poultry, fish and wild game.
- Hickory: Strong bacon flavor. Ideal for beef, pork, poultry, fish and wild game.
- Pecan: Mild, light smokey flavor. Ideal for pork, beef, poultry, and baking. Also popular in the south for sea food.
- Mesquite: Strong, spicy flavor. Distinctive smoky flavor of Southwest cooking. Ideal for beef, pork, poultry, fish and wild game.
- Oak: Mild, wood-fire flavor. Ideal for roasting, grilling, smoking and baking.

CAUTION: Some wood pellets produced for heating fuel have a high content of softwood or even recycled wood furniture which can include pitch, chemicals or glues and should not be used for cooking. For optimum performance and to ensure you are using clean burning pellets manufactured for cooking, purchase "Memphis" certified 100% hardwood BBQ pellets. Using low quality BBQ pellets may also adversely affect your grilling temperature performance — especially at low temperatures. Memphis Wood Fire Grills assumes no responsibility for problems associated with the use of lower quality or heating pellets. Store pellets in a dry location for optimal performance.

Please contact your dealer to purchase additional wood pellets, or call us at 888.883.2260



Periodic Grill Maintenance

Stainless Steel Surfaces

ALWAYS clean dirt and dust off all stainless-steel surfaces before you begin to cook. The dirt can cook into the metal and discolor it. Dirt can be easily cleaned with hot, soapy water and a soft cloth. There are also many commercial products made to clean and protect your stainless-steel surfaces. If the stainless steel becomes severely discolored, this discoloration can be removed with stainless steel cleaner or mild oven cleaner and an abrasive (non-metallic) scrub pad.

Savorizer®

It is recommended that you remove any buildup of food or grease from the Savorizer® before every cook. A clean Savorizer® further reduces flare ups. Brush or scrape any build-up off of the Savorizer® with a grill brush or putty knife. Never clean the Savorizer® while it is hot.

Grease Trays

Always be sure the grease trays are clean and free of debris. During the warmer months empty any grease build-up on a more frequent basis to keep it from going rancid.

Burn Pot

Frequently check the air holes found in the burn pot for any blockages or build-ups. Using the Memphis Genie tool or a wire brush, scrape off any build up or blockage.

This is absolutely critical to the ignition and proper performance of the grill.

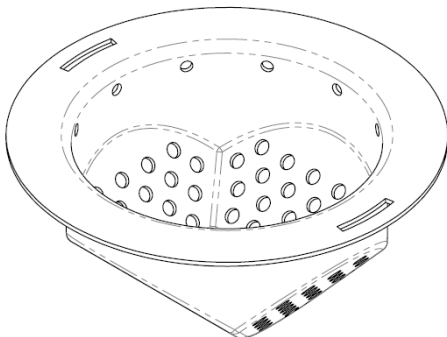

RTD

Your grill's ability to accurately sense temperature and adjust its performance accordingly is what makes it unique and valuable. The RTD, a temperature sensor located towards the rear of the cooking area should be wiped down with water and mild detergent to ensure proper performance.

Grill Interior

Though BBQ pellets burn efficiently, they do create some amount of ash. The grill's interior walls and floor don't need to be spotless, but periodically clearing out accumulated ash is a good practice.

Air Box

Because the air box is used to channel the blower-forced air into the burn pot, there is very little maintenance to be done in this area. Occasionally, you may either vacuum or brush out any build-up of ash or burn debris that has fallen below the burn pot. Remove any accumulation of grease or debris on the inside surfaces. When reinstalling the burn pot, confirm the proper positioning. The burn pot should be level from side to side and from front to back and should have a snug but not tight fit.

Grill Cover

We recommend that you cover your Memphis Grill when not in use. Ensure that your grill is completely off and cooled before covering.

Check out our cleaning and care video, which is available under the Support tab of our website at memphisgrills.com.



Recommended Grilling Accessories

		Maintenance Frequency				
		Every Use	Every 3 Uses	Once a week	Once a Month	Once a Year
Maintenance Task	Scrape Cooking Grate	X				
	Check Grease Pan	X				
	Clear Burn Pot	X				
	Clear Igniter Holes		X			
	Wipe Down Exterior Surfaces		X			
	Scrape off Savorizer®		X			
	Clean Grease Trays		X			
	Wipe Off RTD		X			
	Scrape/ Vacuum Ash from Interior			X		
	Vacuum Fine Pellet Dust from Hopper					X
Wipe Down/ Vacuum out Air Box					X	

*Dependent on cooking frequency



Recommended Grilling Accessories

Meat Probe/Thermometer

The outside temperature, wind conditions, pellet fuel variety and the altitude at which you live affect cooking times. The best way to ensure your meat has reached the proper temperature and is ready to eat is to utilize a good quality meat thermometer. We recommend the Memphis ITC Meat Probe, which can interface directly with your grill's ITC.

Memphis Direct-Flame Savorizer® Insert

Take your grilling to the next level by adding the ability to cook directly over wood-fueled flame. Your grill's EZ- Access Savorizer® Insert can be replaced with a Direct-Flame Savorizer® Insert. This will allow you to sear your foods at very high temperatures. For more information on the Direct-Flame Savorizer® Insert, consult our website, or the appendixes of this manual.

Disposable Grease Trays

Your Memphis grill utilizes at least one grease tray that has been specially designed to accommodate disposable aluminum pans for easy and convenient clean-up. The Pro and Built-In trays are designed to hold two of any 9" X 13" aluminum foil pans.

Tongs

Use tongs rather than a fork for turning and handling meats to avoid losing the natural juices. Extra-large ones with long handles allow you to grip a variety of delicate foods.

Drip / Roast Pans

Used to prevent flare-ups, keep food from drying out, eliminate basting, and catch those flavorful juices that drip from the meat. Various juices can also be added to the pan to impart a desired flavor, such as apple, lemon, cranberry, pineapple, any cola, etc.

Grill Baskets

Perfect for cooking foods that are difficult to handle on the grill, such as vegetables, seafood, fish and certain cuts of meats. Usually made out of stainless steel these baskets are made of two identical halves being held together with hinges. Not only do they protect food, and make handling easier, but also allow for different foods to be combined and grilled together without piercing the food.

Griddle

One of the most used accessories for those grill enthusiasts that enjoy cooking any foods outdoors. Use to grill complete breakfasts, grill sandwiches, and toast fajitas. Griddles allow you to cook all your bacon and sausages outdoors, and they're great for grilling vegetables, stir-frying, and searing.

Spatulas

A must for turning those delicious burgers and fish filets. Again, look for a long, sturdy handle and the widest blade possible. The holes in the blade prevent the build-up of steam, which could make your food soggy.

www.MemphisGrills.com



Recommended Grilling Accessories—continued

Cooking Racks

Stainless steel roast racks and rib racks are a great way to increase your cooking pleasure. Roast racks can be used to enhance the convective cooking capabilities of your grill by allowing the smoke flavored air to move around the entire roast evenly. Rib racks are a great way to increase your capacity of your grill for those large gatherings. They can also be used for chops and chicken pieces. (Additional small grates are available for purchase and will allow you to significantly increase your total cooking surface.)

Basting Brush

You may need a selection of these, as you should not use the same brush in two different marinades. Use to apply your favorite sauces and marinades to foods on the grill. Again look for one with a long handle to keep you hands away from the heat.

Skewers (Wood or Metal)

When using the wood skewers, remember to soak them in water for at least 30 minutes before using to prevent them from burning in the heat of the grill. Another way to protect them would be to wrap the exposed ends with aluminum foil. Skewers come in a variety of shapes and materials.

Aluminum Foil

Extra-strength foil is always useful for grilling. Used to make foil packages, cover food, or to fold up into a flat dish to act as a drip pan. Also used to speed up cooking, protect bones from burning, and to keep foods warm.

Skillets and Woks

These kitchen favorites allow you to stir-grill vegetables, seafood, and other small pieces of food the same way you would if you were indoors.

Putty Knife

Use to scrape grease and other buildup on the Savorizer, side walls of the cook chamber, and other surfaces that may need to be cleaned.

www.MemphisGrills.com

Food Handling Safety Information

- Make sure to wash your hands before and after handling food.
- Prevent bacteria contamination by using separate platters and utensils for raw and cooked foods.
- Marinades should never be saved and reused. If you are going to serve a marinade with your food, be sure to bring it to a boil before serving.
- Keep hot foods hot (above 140°F) and cold foods cold (below 37°F).
- Don't defrost meat at room temperature or on a counter top.
- Marinate meat in the refrigerator.
- Use of a meat thermometer to determine the internal temperatures is recommended.



Approximate Cooking/Grilling Times for Memphis Wood-Fire Convection Grill

Always use a meat thermometer to be sure meats and poultry are cooked to a safe internal temperature. **Serious health risks may exist with undercooked meat!** Approximate cooking times are from various sources, and are based on meat at refrigerator temperatures. We suggest that when grilling at higher temperatures, you apply barbecue sauce only during the last 15 to 30 minutes of grilling to prevent excess browning or burning.

Item	Size	Control Set Point	Approximate Grilling Time	Internal Temp = °F
BEEF				
Steaks	3/4" Thick	450° - 700°	3 to 4 min./side 4 to 5 min./side 5 to 7 min./side	Medium Rare 145 Medium 160 Medium Well 170
Kabobs	1-Inch Cubes	450° - 700°	3 to 4 min./side	145 to 160
Hamburger Patties	1/2" Thick	450° - 700°	3 min./side 4 to 5 min./side 5 to 7 min./side	Medium 160 Medium Well 170 Well Done 180
Roast, Rolled Rump (INDIRECT HEAT) Sirloin Tip (INDIRECT HEAT)	4 to 6 lbs. 3 1/2 to 4 lbs.	350°	18 to 22 min./lb. 20 to 25 min./lb.	145 to 160
Tenderloin	Half, 2 to 3 lbs. Whole, 4 to 6 lbs.	350°	10 to 12 min./side 12 to 15 min./side	Medium Rare 145 Medium 160
HAM				
Fully cooked (INDIRECT HEAT)	any size	350° - 375°	8 to 10 min./lb.	140
Cook-Before-Eating (INDIRECT HEAT)	Whole, 10 to 14 lbs. Half, 5 to 7 lbs. Portion, 3 to 4 lbs.	350° - 375°	10 to 15 min./lb. 12 to 18 min./lb. 30 to 35 min./lb.	160 - 170
LAMB				
Chops, Shoulder, Loin, or Rib	1" Thick	350° - 375°	5 min./side	145 to 160
Steaks, Sirloin, or Leg	1" Thick	350° - 375°	5 min./side	145 to 160
Kabobs	1" Cubes	350° - 375°	4 min./side	145 to 160
Patties, ground	4 oz., 1/2" Thick	450° - 700°	3 min./side	Medium 160
PORK				
Chops, Bone-in or Boneless	3/4" Thick 1 1/2" Thick	450° - 700°	3 to 4 min./side 7 to 8 min./side	Medium 160
Tenderloin	1/2 TO 1 1/2 lbs.	450° - 700°	15 to 25 min. total	Medium 160
Ribs	*See Smoking Guidelines For Pork Ribs*			
Patties, ground	1/2" Thick	450° - 700°	4 to 5 min./side	Medium 160



Item	Size	Control Set Point	Approximate Grilling Time	Internal Temp = °F
VEAL				
Chops, Steak	1" Thick	450° - 700°	5 to 7 min./side	145 to 160
Roast, Boneless (INDIRECT HEAT)	2 to 3 lbs.	350° - 375°	18 to 20 min./lb.	145 to 160
VENISON				
Roast, Saddle, or Leg	6 to 7 lbs.	350° - 375°	25 to 30 min./lb.	145 to 160
Steaks	3/4" Thick	450° - 700°	4 to 5 min./side 6 to 7 min./side	Medium Rare 145 Medium 160
CHICKEN				
Whole (INDIRECT HEAT) Not Stuffed Broiler Fryer Roasting Hen Capon	3 to 4 lbs. 5 to 7 lbs. 4 to 8 lbs. 18 to 24 oz.	325°F [160°C]	60 to 75 min. 18 to 25 min./lb. 15 to 20 min./lb. 45 to 55 min.	180 as measured in the thigh
Breast Halves, bone-in Boneless	6 to 8 oz. each 4 oz. each	325°F [160°C]	10 to 15 min./side 6 to 8 min./side	170
Other Parts: Legs or THIGHS Drumsticks Wings, Wingetts	4 to 8 oz. 4 oz. 2 to 3 oz.	325°F [160°C]	10 to 15 min./side 8 to 12 min./side 8 to 12 min./side	180
DUCK or GOOSE				
Duckling, whole quartered (INDIRECT HEAT)	4 1/2 lbs. (NOT STUFFED)	325°F [160°C]	2 1/2 hrs. 1 hr., 25 min.	180 to 185
Goose, whole (INDIRECT HEAT)	8 to 12 lbs.	325°F [160°C]	18 to 20 min./lb.	180 to 185
TURKEY				
Whole Turkey (INDIRECT HEAT)	8 to 12 lbs. 12 to 16 lbs. 16 to 24 lbs.	325°F [160°C]	2 to 3 hrs. 3 to 4 hrs. NOT recommended	180 as measured in the thigh
Breast, bone-in Boneless	4 to 7 lbs. 2 3/4 to 3 1/2 lbs.	325°F [160°C]	1 to 1 3/4 hrs. NOT recommended	170
Thighs, Drumsticks (INDIRECT HEAT)	8 to 16 oz.	325°F [160°C]	1 1/2 to 2 hrs. 8 to 10 min./side	180
Boneless Turkey Roll (INDIRECT HEAT)	2 to 5 lbs. 5 to 10 lbs.	325°F [160°C]	1 1/2 to 2 hrs. 2 to 3 1/2 hrs.	170 to 175



Smoking Guidelines

Approximate Smoking Times for Memphis Wood-Fire Grill

Always use a meat thermometer to be sure meats and poultry are cooked to a safe internal temperature and doneness. **SERIOUS HEALTH RISKS MAY EXIST WITH UNDERCOOKED MEAT!** Approximate cooking times are, from various sources and are based on meat at refrigerator temperatures. Use a good quality temperature probe to assure best results. We suggest that when grilling at higher temperatures, you apply barbecue sauce only during the last 15 to 30 minutes of grilling to prevent excess browning or burning. **NOTE: KEEP HOOD CLOSED WHEN USING SMOKE MODE.**

Smoking times are largely dependent on personal preference and the quality of the meat being smoked. **IN GENERAL THE LONGER YOU SMOKE THE MEAT AT A LOWER TEMPERATURE THE MORE TENDER THE MEAT WILL BECOME.** You will also need to consider how much of a smoke taste you want and what flavor—oak, hickory, pecan, apple, cherry, mesquite are some of the most common.

For best results we recommend that you smoke at a set point temperature of 225-275° for most meats. If you wish to have a smokier flavor and have the time, you can go as low as 180°, but you usually don't gain much by doing that.

It should also be noted that, when smoking in a very warm environment (sunny weather in excess of 90°F), it may be difficult for your grill to maintain temperatures lower than 200°F.

The following is a general guide, and we recommend you experiment to find what temperature and flavor best suits your personal taste. If you want to finish faster use higher temperature. Note: This will in most cases result in a less tender product. When you have the time, a lower temperature for a longer duration will give you the best results. For additional tips, and to view and share recipes, go to www.memphisgrills.com/recipe.

Item	Control Set Point °F	Internal Temp = °F
Beef	180°-275°	145°-160°
Ham	180°-275°	140°-170°
Lamb	180°-275°	145°-160°
Pork, fresh	180°-275°	160°-180°
Veal	180°-275°	145°-160°
Venison	180°-275°	145°-160°
Chicken	180°-275°	170°-180°
Duck or Goose	180°-275°	180°-185°
Turkey	180°-275°	180° as measured in the thigh



Smoking Suggestions

The following are a few important facts, tips and techniques to achieve great smoking results. There are probably as many theories on the best smoking method as there are chefs using them. With that in mind, consider the following factors when deciding which method best fits your needs.

- The Memphis Grill's smoking mode range is 180° to 295°F.
- If you wish to smoke at lower temperatures all Memphis models are calibrated to allow you to go as low as 180° F. *When smoking at the lower temperatures it's critical that you use a premium food grade pellet such as "Memphis" branded BBQ Pellets.* Memphis premium pellets are specially formulated to allow for more even feeding and temperatures. For best results, always use Memphis premium pellets.
- It is strongly recommended that the burn pot be cleaned before and after smoking for a significant period. Unchecked ash build-up could eventually prohibit the grill from maintaining smoking temperatures.
- **Caution:** We don't recommend that you use the lower temperatures when smoking in cool and or windy conditions. *At temperatures less than 225° the possibility of creosote* developing from smoke condensation arises.* As always use your best judgment, clean your grill often, and proceed on the side of safety and caution.
- The best way to determine where you get the best results is to experiment. We all have different tastes and the best way to determine what's right for you is to try different flavors and techniques.

We encourage you to share your cooking experiences with other Memphis owners by going to our web site <http://www.memphisgrills.com/recipes>, our blog site, or on our Facebook page.

**Creosote is a gummy, foul smelling corrosive and flammable substance that , if no precautions are taken, will coat the insides of everything it passes through. It is formed when gases given off in the burning process combine and condense. Typically the gases leave the burn chamber with the smoke. However, if restricted too much or if the smoke is cooled below 225°, the gases can liquefy, forming creosote.*



Troubleshooting and Error Messages

In the event that your Memphis grill encounters any kind of issue or problem in operation, please consult this chart. If the solutions offered here are insufficient to resolve the matter, please contact your dealer, or Memphis Wood Fire Grills directly at the number found at the end of this manual.

<u>Problem</u>	<u>Cause</u>	<u>Solution</u>
Error Message "ER- 1 Grill Overheat"	The appliance has overheated, possibly due to a grease fire, or excess fuel.	Turn the grill off and allow it to cool. If necessary, follow the procedure in the General Warning section. Clean grill interior and clear off excess fuel before restarting.
Error Message "ER- 2 Failed to Light"	The appliance has failed to ignite within the allotted 20minutes.	Check the hopper for sufficient fuel. Check the burn pot for ash build-up or other obstructions. Check igniter to see if it is heating up (igniter may need replacing). In extreme cold, grill may require additional priming to achieve ignition. Make sure hood is closed.
	Grill will not stay lit.	Check the hopper for sufficient fuel. Check the burn pot for ash build-up or other obstructions. Blower not supplying the air needed to maintain a flame. Check igniter to see if it is heating up, used to recover if temperature falls below the set temperature. Make sure hood is closed.
Error Message "ER- 3 Unplugged Before Cooldown"	The appliance has power failure during operation.	Ensure that your grill is securely plugged in. Check for power-failures within your home.
Error Message "ER- 4 RTD Shorted"	RTD or Meat Probes damaged	Check resistance of RTD and meat probes Replace RTD harness, meat probe, or probe jack. Contact Memphis Grills Technical Support.
Error Message "ER- 5 RTD Open"	There is a malfunction with either the RTD or Meat Probes or a wire has disconnected.	Check continuity of RTD and meat probes Replace RTD harness, meat probe, or probe jack. Contact Memphis Grills Technical Support.
Error Message "ER- 6 CPU Overtemp"	Electrical Compartment is becoming too hot for the controller.	Verify the Auxiliary fan is spinning once the grill is put into start mode. Replace Auxiliary fan. Contact Memphis Grills Technical Support.
Error Message "ER- 8 Invalid Mode, Check Set Temp"	ITC doesn't reflect to selected grill mode	Change the set temperature Press and hold push button for 10 seconds to reset controller.
Error Message "ER-9 Igniter Fault"	Igniter Fuse blown, igniter damaged, or break in igniter harness wires.	Verify continuity of Igniter harness Check 4A SLO-BLO fuse for continuity Contact Memphis Grills Technical Support
Error Message "ER-10 SD Card Fault"	SD card not inserted, damaged, or missing	Disconnect SD card from control board and re-insert. Restart grill by unplugging and plugging back in Contact Memphis Grills Technical Support
Grill Will Not Turn On	Grill is not properly plugged in.	Ensure that your grill is plugged into a working GFCI outlet.
	A power surge has damaged one of the fuses on the ITC.	Fuse must be manually replaced. See guide at the end of this section Contact Memphis Grills Technical Support
Grill Produces Excess or Discolored Smoke	Wood pellets have absorbed excess moisture.	Clear the hopper and burn pot of moist pellets, replacing them with dry pellets.
	Burn pot is overloaded with ash build-up.	Check the burn pot for ash build-up or other obstructions.



Troubleshooting and Error Messages Continued

<u>Problem</u>	<u>Cause</u>	<u>Solution</u>
Grill Will Not Achieve Or Maintain Stable Temperature	Grill isn't receiving sufficient fuel.	Check the hopper for sufficient fuel. Ensure both sides of the hopper are filled. Verify that auger motor is rotating.
	Grill isn't receiving sufficient air-flow.	Check to see if blower have been unplugged or have failed. Contact dealer or Memphis Grills directly in case of blower failure.
	Burn-pot is overloaded with ash build-up.	Check the burn pot for ash build-up or other obstructions. Check to see if blower have been unplugged or have failed.
Frequent Flare-ups are experienced	Flammable material build-up.	Clean out ash drawer and scrap grease off Savorizer®
Cooking temperatures are uneven	Unbalanced airflow throughout the grill.	Ensure that Savorizer® is installed correctly

Fuse Information

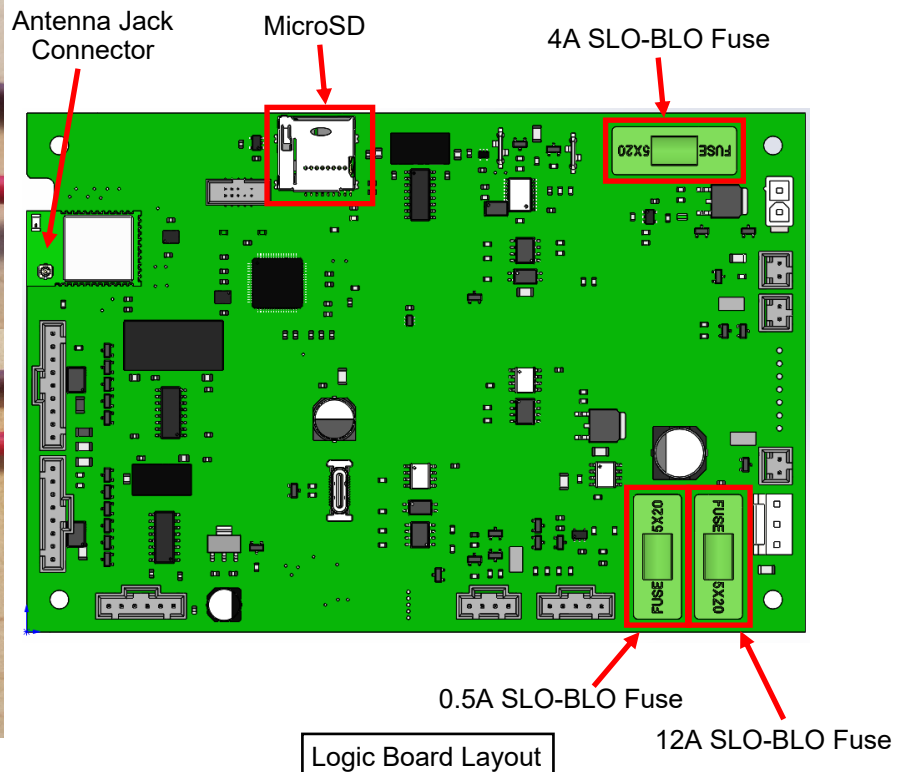

Power Cable (VG1969) Fuse

- VG9021– Fuse Glass 250VAC 5A 5 x 20 mm



Memphis Wood Fire Grills Limited Warranty

Products manufactured by Memphis Wood Fire Grills carry a seven (7) year (Pro and Elite) or five (5) year (Beale Street) Limited Warranty, from the date of purchase by the original owner against defects in material and workmanship. Electronic and electrical components carry a three (3) year (Pro and Elite) or two (2) year (Beale Street) replacement warranty when subjected to normal residential use. Limited Warranty does not apply to burn pot, meat probe, grill cover gaskets or damage caused by corrosion. The meat probe is under Warranty for 30 days from the date of purchase.

Conditions of Limited Warranty

During the term of the Limited Warranty, Memphis Wood Fire Grills' (MWFG) obligation shall be limited to replacement of covered, failed components, F.O.B. point of shipment. MWFG will repair or replace parts returned to MWFG, freight prepaid, if the part(s) are found by MWFG to be defective upon examination. MWFG shall not be liable for transportation charges, labor costs, or export duties. Except as provided in this CONDITIONS OF LIMITED WARRANTY, repair or replacement of parts in the manner and for the period of time stipulated hereunder shall constitute the fulfillment of all direct and derivate liabilities and obligations from MWFG to you.

The Warranty coverage begins on the original date of purchase as stated on the sales receipt. Warranty Registration and proof of original date of purchase is required to validate the Limited Warranty.

Repair or replacement of the MWFG component does not extend the Limited Warranty.

Pouring hot liquids on or in your MWFG product will void this warranty. Any modifications including holes, screws, and any other sheet metal changes to the product will void this warranty.

MWFG takes every precaution to utilize materials that retard rust. Even with these safeguards, the material can be compromised by various substances and conditions beyond MWFG control. High temperatures, excessive humidity, chlorine, industrial fumes, fertilizers, lawn pesticides and salt are some of the substances that can affect metals and metal coatings. For these reasons, the Limited Warranty DOES NOT COVER RUST OR OXIDATION, unless there is a loss of structural integrity on the grill component. Should any of the above occur, refer to your Owner's Manual maintenance section for finish protection. MWFG recommends that you purchase a MWFG full-length protective cover for your grill when not in use.

The Limited Warranty is based on residential use. Warranty coverage does not apply to products used in commercial applications. Shipping costs for the product is not covered by the Warranty.

Exceptions to the Limited Warranty

There is no written or implied performance warranty on MWFG Products as the manufacturer has no control over the installation, operations, cleaning, maintenance or the type of fuel burned.

This Limited Warranty will not apply if your product has not been installed, operated, cleaned and maintained in strict accordance with the manufacturer's instructions. Burning anything other than Premium Grade BBQ wood pellets may void the Warranty. Memphis recommends using Memphis Wood Fire Pellets. The Warranty does not cover damage or breakage due to misuse, improper handling or modifications.

Neither the manufacturer, nor the suppliers to the purchaser, accepts responsibility, legal or otherwise, for the incidental or consequential damage to the property or persons resulting from the use of this product.



Any warranty implied by law, including but not limited to implied warranties of merchantability or fitness, shall be limited to one (1) year from the date of original purchase. Whether a claim is made against the manufacturer based on the breach of this warranty or any other type of warranty expressed or implied by law, manufacturer shall in no event be liable for any special, indirect, consequential or other damages of any nature whatsoever in excess of the original purchase price of this product. All warranties by manufacturer are set forth herein and no claim shall be made against manufacturer on any oral warranty or representation.

Some states do not allow the exclusion or limitation of incidental or consequential damages, or limitations of implied warranties, so the limitations or exclusions set forth in this Limited Warranty may not apply to you. This Limited Warranty gives you specific legal rights and you may have other rights, which vary from state to state.

The Limited Warranty for seven (7) years (Elite and Pro) or five (five) years (Beale Street) is in lieu of all other warranties expressed or implied, at law or otherwise, and MWFG does not authorize any person or representative to assume for MWFG any obligation or liability in connection with the sale of this product. This means that no warranties, either expressed or implied are extended to persons who purchase the product from anyone other than MWFG or an authorized MWFG Dealer or Distributor.

Procedure for Warranty Service

1. Complete your Warranty Registration by filling out and mailing the Warranty Registration Form at the end of this Owner's Manual, or submit it online by going to www.memphisgrills.com or by scanning the QR code below with your camera:



2. Contact your nearest Memphis Grills Dealer for service and/or part replacement as stated under the conditions of the Limited Warranty.
3. Be prepared to provide the following: purchaser's name, date of purchase, copy of dated sales receipt, model and serial number of product and an accurate description of the problem.

We strongly recommend you first contact your nearest Memphis Grills Dealer for sales and service. If further assistance is needed call Memphis Wood Fire Grills Customer Service and Technical Support at 1-888-883-2260.



Thank You for Choosing the Memphis Wood Fire Convection Grill!

Congratulations on your purchase of the Memphis Wood Fire Grill. With proper care and maintenance, your grill will give you years of trouble-free operation. Please review the following information carefully for useful tips and information that will help you utilize your grill's extensive features and benefits.

Keep in mind that your Memphis Wood Fire Grill is so much more than a grill. It's a 3-in-1 outdoor cooking center that provides the convenience, wood-fire flavors and versatility of three appliances: high temperature grill, low 'n' slow smoker, high- performance convection oven.

Fueled by certified 100% natural wood pellets, the Memphis has a digital Intelligent Temperature Control (ITC) that automatically maintains your desired cooking temperatures, just like your indoor oven. The result is a simple "set it and forget it" way to cook, bake, roast, sear, or low and slow smoke; just set the desired temperature, sit back and enjoy.

We all have our favorite recipes and cooking tricks. We suggest you experiment with your new grill to discover just how many ways it adds to your outdoor cooking experience. With a little time and effort you'll amaze your friends and family with your impressive culinary skills. Like many others, you'll find that your Memphis Wood Fire Grill will become your cooking appliance of choice for barbecuing, smoking, and a secondary oven source for holidays or social gatherings.

Please complete the below information for quick and easy reference for your records. Additionally, complete the online Warranty Registration using the below information to validate the Warranty. At the end of this Owner's Manual is a printed copy of the Warranty Registration if you choose to mail in your form. Your model and serial number are located on the sticker under the hopper lid.

Thank you for choosing the Memphis Wood Fire Grill!

Memphis Wood Fire Grills
9111 Grand Avenue South
Bloomington, MN 55420



Warranty Registration Form



Register online at <http://memphisgrills.com/warranty-registration/> or by scanning this QR Code:

You can also register by completing this form and returning it within 30 days of purchase.

Warranty coverage begins on the original date of purchase. Proof of original date of purchase from an authorized Memphis Grills Dealer is required to validate Warranty. Without receipt of Warranty Registration and proof of date of purchase, the warranty will begin from ship date to Dealer or Retailer.

****Required Fields***

First Name* _____

Last Name* _____

Mailing Address* _____

City* _____

State/Province* _____

Postal Code* _____

Country* _____

Phone Number _____

Email _____

All Product Information is located under the pellet hopper lid.

Model* _____

Model Number* VG _____

Serial Number* (Last 4-5 digits) _____

Send Warranty Registration Form and dated sales receipt to:

Memphis Grills
Memphis Grill Warranty Registration
9111 Grand Avenue South
Bloomington, MN 55420

Contact Memphis Grills Customer Service with any questions: 1-888-883-2260