

# **MEGAMON 15**

## **LCD Monitor**

### **User Manual**

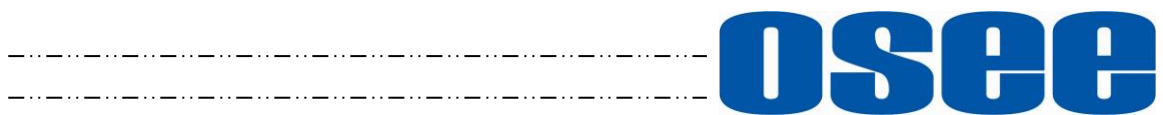



# **osee** OSEE TECHNOLOGY LTD.

## **Product Information**

**Model:** MEGAMON 15 LCD Monitor

**Version:** V010000

**Release Date:** November 22th, 2021

---

## **Company**

OSEE TECHNOLOGY LTD.

---

## **Contact Information**

**Address:** No.22 Building, No.68 zone, Beiqing Road, Haidian District,  
Beijing, China

**Post Code:** 100094

**Tel:** (+86) 010-62434168

**Fax:** (+86) 010-62434169

**Web:** <http://www.osee-dig.com/>

**E-mail:** [sales@osee-dig.com](mailto:sales@osee-dig.com)

# About this manual

## Important

The following symbols are used in this manual:

### **Tips**

---

- The further information or know-how for described subjects above which helps user to understand them better.
- 

### **Warning**

---

- The safety matters or operations that user must pay attention to when using this product.
- 

## Contents

The user manual applies to the following device types:

- ❖ **MEGAMON 15**

The images of MEGAMON 15 are adopted in the following descriptions. Before reading the manual, please confirm the device type.

## Contents

<b>Contents .....</b>	<b>I</b>
<b>Chapter 1 Overview .....</b>	<b>1</b>
<b>Chapter 2 Safety.....</b>	<b>3</b>
<b>Chapter 3 Unpack and Installation .....</b>	<b>7</b>
<b>Chapter 4 Locations and Function of Parts and Control.....</b>	<b>11</b>
<b>4.1 Front Panel Features .....</b>	<b>12</b>
4.1.1 Arrangement of Front Panel .....	12
4.1.2 Operation of Front Panel .....	14
<b>4.2 Rear Panel Features.....</b>	<b>17</b>
4.2.1 Arrangement of Rear Panel .....	17
4.2.2 Operations of Rear Panel .....	19
<b>4.3 Supported Signal Format .....</b>	<b>20</b>
<b>Chapter 5 Menu Operations .....</b>	<b>23</b>
<b>5.1 MAIN menu .....</b>	<b>23</b>
5.1.1 STATUS Menu .....	25
5.1.2 INPUT CONFIG Menu .....	26
5.1.3 COLOR MANAGEMENT Menu .....	27
5.1.4 USER CONFIG Menu.....	32
5.1.5 IMD CONFIG Menu .....	54
5.1.6 KEY INHIBIT Menu.....	55
<b>5.2 Menu Settings.....</b>	<b>56</b>
<b>Chapter 6 Specifications .....</b>	<b>59</b>



## Chapter 1 Overview

The MEGAMON 15 LCD Monitor is a high performance field/studio monitor tailoring most applications from program production, intensive upload/download, playout to studio and intensive monitoring all sorts of business in TV Stations.

The front frame of the unit comes in a slim bezel design made from rubber mold. The professional TFT glass at full resolution of 1920x1200 UHD with LED backlight makes the MEGAMON 15 LCD monitor capable of reproducing a natural color at quickest response time. In addition, the unit boasts a full wide viewing angle as well as excellent brightness and contrast ratio.

By adopting the advanced 10-bit digital signal processing technology plus 3D comb filter, de-interlacing capability and accurate scaling ensures the MEGAMON 15 LCD Monitor to achieve a better effect of smoother and more natural image.

The MEGAMON 15 LCD Monitor supports up to 2Ch 3G/HD/SD-SDI inputs, 1Ch VIDEO input, one HDMI input and 1Ch 3G/HD/SD-SDI output.

It also has a full package of video assisting tools like waveform, vector scope, histogram, zebra, audio meter, focus assist, exposure assist, TC, IMD and all kinds of markers.



**Figure 1 A Diagram of MEGAMON 15 Monitor**

## Features

- Prevailing slim bezel design
- Having multi-format input including 3G/HD/SD-SDI, VIDEO and HDMI
- Adopting full HD, wide viewing angle TFT glass
- Using 10-bit signal processing technology plus advanced conversion technology between the interlacing and the progressive
- Support waveform, vector scope, histogram and audio meter
- Support HDR technology and wide range color space
- Support multiple color space: SMPTE-C, EBU, ITU709, ITU2020, P3
- Support multiple assistants: zebra, focus assist, exposure assist, etc.
- Support IMD remote control
- Support MARKER, Time Code, MET display
- Support presetting the color temperature using customized values



## **Chapter 2 Safety**

### **FCC Caution:**

Any Changes or modifications not expressly approved by the party responsible for compliance could void the user's authority to operate the equipment.

This device complies with part 15 of the FCC Rules.

Operation is subject to the following two conditions: (1) This device may not cause harmful interference, and (2) this device must accept any interference received, including interference that may cause undesired operation.

Note: This equipment has been tested and found to comply with the limits for a Class B digital device, pursuant to part 15 of the FCC Rules. These limits are designed to provide reasonable protection against harmful interference in a residential installation. This equipment generates uses and can radiate radio frequency energy and, if not installed and used in accordance with the instructions, may cause harmful interference to radio communications. However, there is no guarantee that interference will not occur in a particular installation. If this equipment does cause harmful interference to radio or television reception, which can be determined by turning the equipment off and on, the user is encouraged to try to correct the interference by one or more of the following measures:

Reorient or relocate the receiving antenna.

Increase the separation between the equipment and receiver.

Connect the equipment into an outlet on a circuit different from that to which the receiver is connected.

Consult the dealer or an experienced radio/TV technician for help.

## Warnings:

Read, keep and follow all of these instructions for your safety. Heed all warnings.

### **Warning**

---

#### Device

- Install in accordance with the manufacturer's instructions.
  - Do not beat with a hard object or scratch the LCD display.
  - Do not make the freeze picture displaying on the screen time too long, otherwise, it will leave the afterimage on the screen.
  - If the brightness is adjusted to the minimum, then it might be hard to see the display screen.
  - Refer all servicing to qualified service personnel. Servicing will be required under all of the following conditions:
    - The unit has been exposed to rain or moisture.
    - Liquid had been spilled or objects have fallen onto the unit.
    - The unit has been damaged in any way, such as when the power-supply cord or plug is damaged.
    - The unit does not operate normally.
  - Clean only with dry cloth.
  - Specifications are subject to change without notice.
- 

### **Warning**

---

#### Position

- Do not block any ventilation openings.
- Do not use this unit near water.
- Do not expose the unit to rain or moisture.
- Do not use this unit near any heat sources such as radiators, heat registers, stoves, or other apparatus (including amplifiers) that product

heat.

- A nameplate indicating operating voltage, etc., is located on the rear panel.
  - The socket-outlet shall be installed near the equipment and shall be easily accessible.
- 

## **Warning**

---

### **Power Supply Cord**

- Do not defeat the safety purpose of the polarized or grounding-type plug.
  - Do not damage the power cord, place heavy objects on the power cord, stretch the power cord, or bend the power cord.
  - Protect the power cord from being walked on or pinched, particularly at plugs, convenience receptacles, and the point where they exit from the unit.
  - If the power cord is damaged, turn off the power immediately. It is dangerous to use the unit with a damaged power cord. It may cause fire or electric shock.
  - Unplug this unit during lightning storms or when unused for long periods of time.
  - Disconnect the power cord from AC outlet by grasping the plug, not by pulling the cord.
  - Should any solid object or liquid fall into the cabinet, unplug the unit and have it checked by qualified personnel before operating it any further.
-

02222222

## Chapter 3 Unpack and Installation

### Unpack:

When unpacking the components of MEGAMON 15 monitor, please verify that none of the components listed in Table 3.1 are damaged or lack. If there is any missing, contact your distributors or Osee Technology Ltd. for it.

**Table 3-1 Packing List**

No.	Item	Quantity
1	Monitor	1
2	Carrying Bag with Shoulder Strap	1
3	Battery Plate with a D-tap to XLR Cable and 5 Screws	1
4	Cheese Plate with 2 Screws	1
5	C-stand Adapter with 3 Screws	1
6	Power cord	1
7	HDMI Cable Lock (2 parts)	1
8	Desktop Feet with 2 Screws	2
9	Velcro Strips	1
10	Quick Start Guide	1
11	Service Card	1

### Installation:

#### 1. Prepare for installation

Please follow the procedures below before installing MEGAMON 15:

- Check the equipment for any invisible damage that may have occurred during transit.
- Confirm all the items listed on the packing list have been received.
- Remove all the packing material including electrostatic-resistant packing.
- Retain these packing materials for future use.

#### 2. Mount a MEGAMON 15 in your desired location. Adequate ventilation is required when installed to prevent possible damage to the MEGAMON 15.

There are screw holes at the rear panel of the monitor, which are labeled in the following figures. Assemble the parts of the stands, then insert the stands into the case, and fasten it with the screws provided. The stands installation for MEGAMON 15 are as follows:

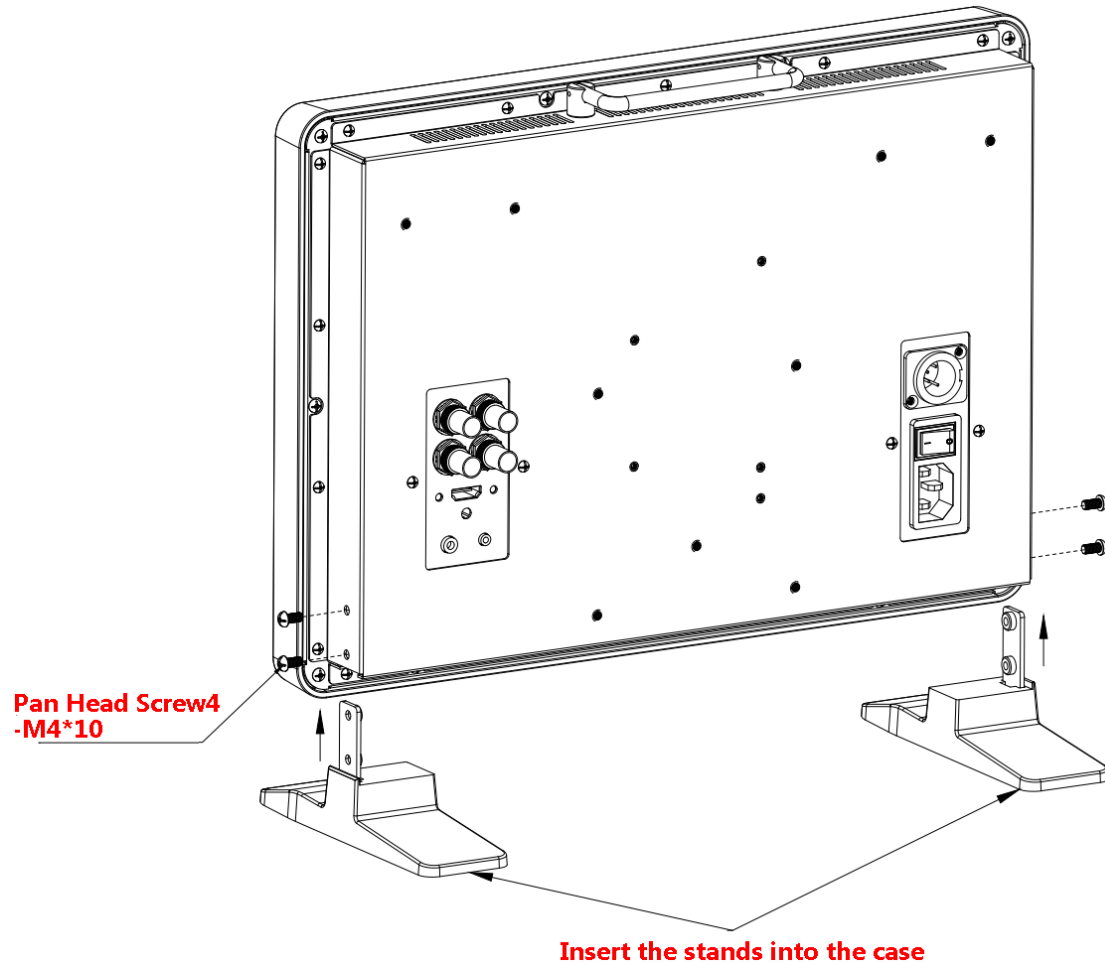

**Figure 3-1 Stands for MEGAMON 15**

Battery plate has 2 options: AB or V-mount, figure shows V-mount, D-tap to XLR cable not shown.

Cheese plate, battery plate and C-stand adaptor are pre-installed before shipping.

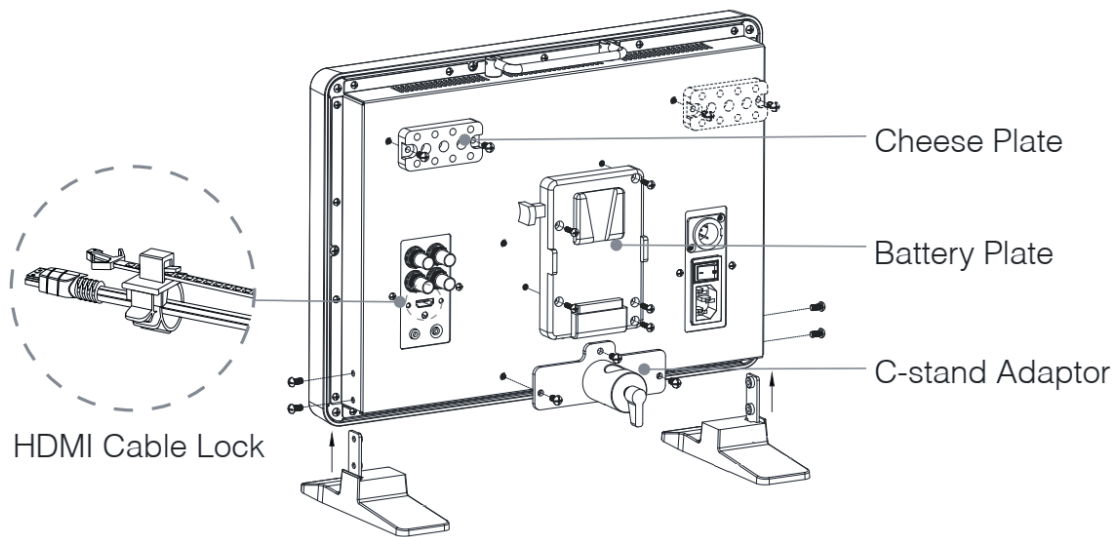

**Figure 3-2 Accessory for MEGAMON 15**

**i Tips**

- Please notice that once the HDMI cable lock is inserted into the lock hole, it CAN'T BE REMOVED unless the rear panel is disassembled.

3. Connect required cables for signal input and output. For BNC connections use 75Ω rated connectors.
4. Connect 100~240V50/60Hz AC or 11~17V3A DC battery(with optional battery plate) using the power cord.
5. Connect the power cord to the power interface.
6. Fasten the power protect accessory.
7. As a final step, turn on the device by pressing the corresponding power switch located on the front panel.

**i Tips**

- The pedestal and the monitor are packaged separately.
- Connect a standard signal line to the corresponding input port. All BNC connector impedance must be 75Ω.
- Please use the power cord supplied to avoid unnecessary trouble.

032222



## Chapter 4 Locations and Function of Parts and Control

This chapter describes the features of MEGAMON 15 monitor. The features of MEGAMON 15 monitor are as shown in Figure 4-1 after installed and powered on:



**Figure 4-1 Features of MEGAMON 15 Monitor**

### 1. Status Information

The **Status Information** is displayed in the top left corner of the screen, and includes the input channel, signal format and battery indicator. You can define it in **USER CONFIG** menu.



### 2. Waveform and Vector

The waveform and vector of the input signal are configurable in the MAIN menu.

### 3. Aspect Marker

It is used to mark different area of the image. You can set whether to display it or not and their displaying mode in **USER CONFIG** menu.

### 4. Area Marker

It is used to mark different area of the image. You can set whether to display it or not and their displaying mode in **USER CONFIG** menu

#### 5. Center Marker

It is displayed in the center of the screen, and marks the center of the image. You can set whether to display it or not in **USER CONFIG** menu.

#### 6. Audio Meter

It is displayed for audio monitoring. You can set its groups, position and mode in **USER CONFIG** menu.

#### 7. Timecode

It is displayed at the bottom of the image, the format is HH:MM:SS:FF, if there is no timecode available, the monitor will display --:--:--:--. This is effective only for SDI signal.

#### 8. IMD

The IMD text displays at the bottom of the screen, the length can't exceed 16 characters, and you can choose letter, number or other character for it.

### Tips

---

- The **Status Information** usually displays as the following situations:
    - "UNKNOWN" appears if an unsupported signal is input.
    - "NO SIGNAL" appears if no signal is input.
    - The signal is normal, for example: 1080i59.94, 720P50, etc.
- 

## 4.1 Front Panel Features

This part will introduce the arrangement and the operations of the buttons on the front panel in the following.

### 4.1.1 Arrangement of Front Panel

There are a series of buttons at the bottom of the screen, and these buttons are used to control the screen menu items.

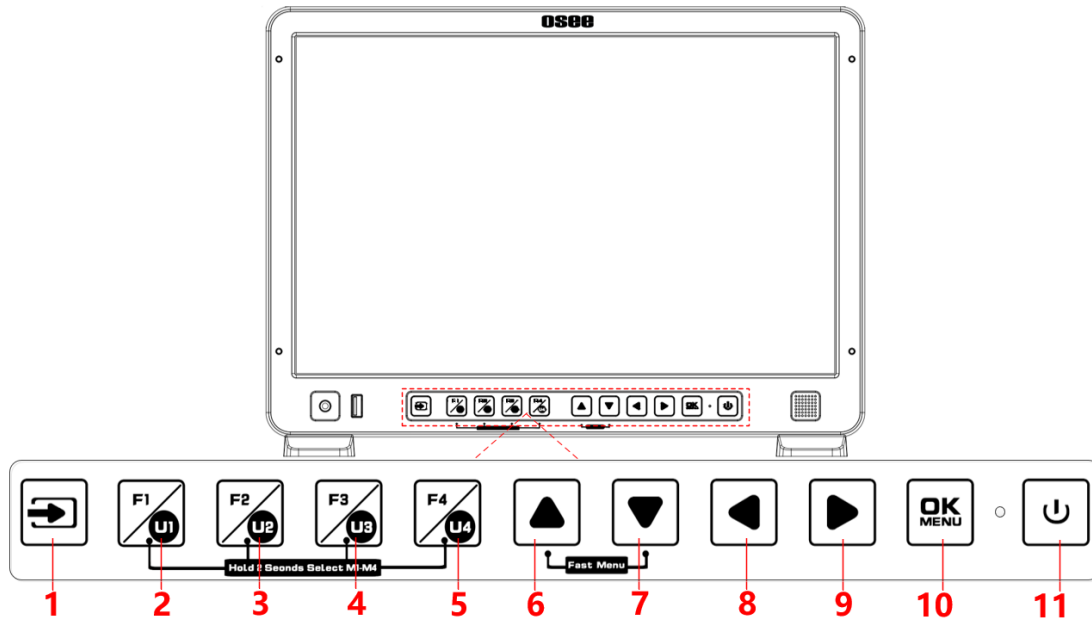

**Figure 4.1-1 the Buttons in Front Panel**

As shown in Figure 4.1-1, the buttons of MEGAMON 15 are as follows:

BUTTON	FUNCTION	BUTTON	FUNCTION
	Input selection		Adjust upward/ Fast Menu
	Function button F1/ User Preset button U1		Adjust downward/ Fast Menu
	Function button F2/ User Preset button U2		Return/Exit
	Function button F3/ User Preset button U3		Select next
	Function button F4/ User Preset button U4		Save/Return/MAIN menu
			Power on/off

### Tips

- The power button has a light indicator.

## 4.1.2 Operation of Front Panel

The functionality and usage of the buttons at the front panel are as follows:

1. : **Input Selection**

Select the input signal from each input interface. Press this button to display the Input Source menu at the top right corner of the screen, as shown in Figure 4.1-2. Press the input button or UP/DOWN button to select your input type.

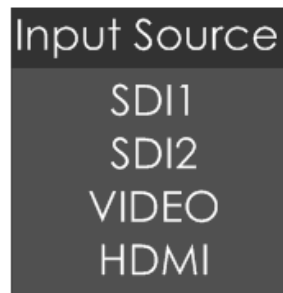

**Figure 4.1-2 Source Menu**

2. : **F1/U1**

This button is a **FUNCTION** and **User Preset** button.

- F1 function:** The F1 function can be assigned via the USER CONFIG menu. Press the function button to activate or deactivate the assigned function. Press **F1** to display the function menu list in the left bottom of the screen, as shown in Figure 4.1-3. Toggle **F1** button to change the value related to this function.



**Figure 4.1-3 Function Menu List**

- USER1:** Switch to **User Preset USER1** directly. Hold 2 seconds to select the current user preset to be User1. The name of the current user preset will be prompted on the left bottom of the screen. Refer to “5.1.4.1 FUNCTION KEY and User Preset Menu” for the setting of **User Preset**.

**i Tips**

- If the value related to the function button can't be modified, the value shows in gray.
- For **F2/U2~F4/U4** function buttons, the operations are as the same as F1/U1's.
- Use **FUNCTION KEY** menu to assign F1~F4. You can assign the function from among: Camera LUT, Undef, Blue Only, Mono, Marker, Audio Meter, Time Code, Waveform Type, Vectorscope, Histogram, Scan, Aspect/Anamorphic, Native, Mute, IMD Display, False Color, Focus Assist, Peak, Zebra. Refer to "5.1.4 USER CONFIG Menu" for the details.

3. : **UP ARROW**

- It is **UP** button when working with the MAIN menu. Toggle this button to select the next item or increase the number.
- Without the MAIN menu: when not displaying the MAIN menu, press **UP** button to display the **Fast Menu** list, as shown in Figure 4.1-4, toggle among these menu items: **Volume, Brightness, Contrast, Saturation, Backlight** and **Sharpness**.



**Figure 4.1-4 Fast Menu List**

After displaying the **Fast Menu**, press **LEFT** or **RIGHT** arrow button to adjust the menu value.

The limitations of these items are shown in Table 4.1-1:

**Table 4.1-1 The Description of Fast Menu Items**

Adjust Menu	Description	Range	Default
Volume	Adjust the volume	0~31	16
Brightness	Adjust the image brightness	0~100	50
Contrast	Adjust the image contrast	0~100	50
Saturation	Adjust the image color intensity	0~100	50

Adjust Menu	Description	Range	Default
Backlight	Adjust the backlight	0~10	5
Sharpness	Adjust the image sharpness	0 ~ 63	8

## Tips

- After you have loaded the adjust menu list, it will be closed automatically if you do nothing operation on it within the **Osd Time**.
- The MAIN menu, the fast menu, the function menu and the input signal selection list of a screen may not be shown all simultaneously.

### 4. : **DOWN ARROW**

- It is **DOWN** button when working with the MAIN menu. Toggle this button to select the next item or decrease the number.
- Without the MAIN menu: when not displaying the MAIN menu, press **DOWN** button to display the **Fast Menu** list, refer to the details in the above description as in UP arrow button.

### 5. : **LEFT ARROW**

Press this button to do the following operations:

- With the MAIN menu: when working with the MAIN menu, LEFT button achieve the following functions:
  - Back to the higher level menu
  - Back to the higher level menu and not save the setting of the menu item value
  - Quit the MAIN menu
- With the Fast menu: when displaying the Fast menu, press **LEFT** button to decrease the item value.

### 6. : **RIGHT ARROW**

Press this button to do the following operations:

- With the MAIN menu:
  - Enter into the next level menu.

- Turn Page: when the current selection in the sub-menu list is **Next Page**, press this button to turn to the next page circularly.
- With the Fast menu: when displaying the Fast menu, press RIGHT button to increase the item value.

7. : **OK/MENU**

It is used to activate the MAIN menu. Press this button to do some operations with the MAIN menu, it includes the following operations:

- Display the MAIN menu: press **OK/MENU** button, it will display the MAIN menu at the center of the screen.
- Save/Back: confirm the selection and back to the higher level menu.
- Turn Page: when the current selection in the sub-menu list is **Next Page**, press this button to turn to the next page circularly.

8. **Power**

Used to power on or standby, and the light in the button will indicate the status of the power. After connect to the power, the light is red that is in standby mode, then press the Power button, the monitor is powered on, and the light is green. Then press the power button again and hold 4 seconds to enter the standby mode, the light is red.

## 4.2 Rear Panel Features

It will introduce the arrangement and the operations of the interfaces in rear of the panel in the following.

### 4.2.1 Arrangement of Rear Panel

For the arrangement of the rear panel of MEGAMON 15 is shown in Figure 4.2-1, there are various input and output interfaces at the rear panel, and build-in speakers in the front panel.

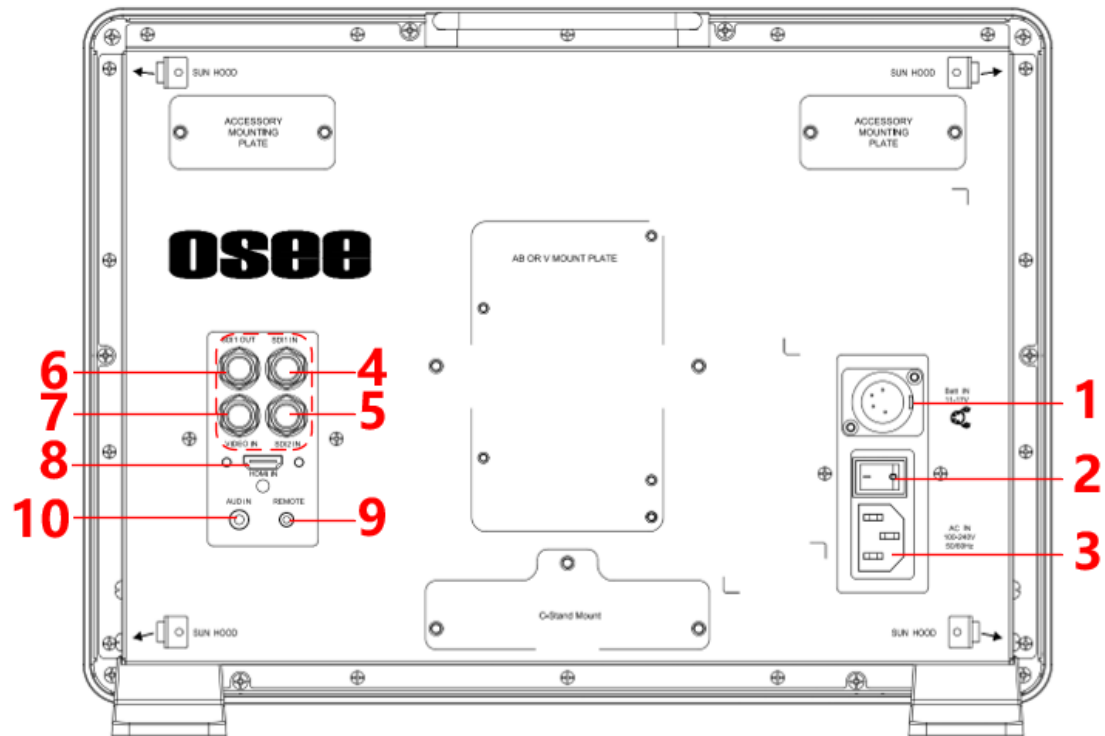

Figure 4.2-1 The Rear Panel of MEGAMON 15 Monitor

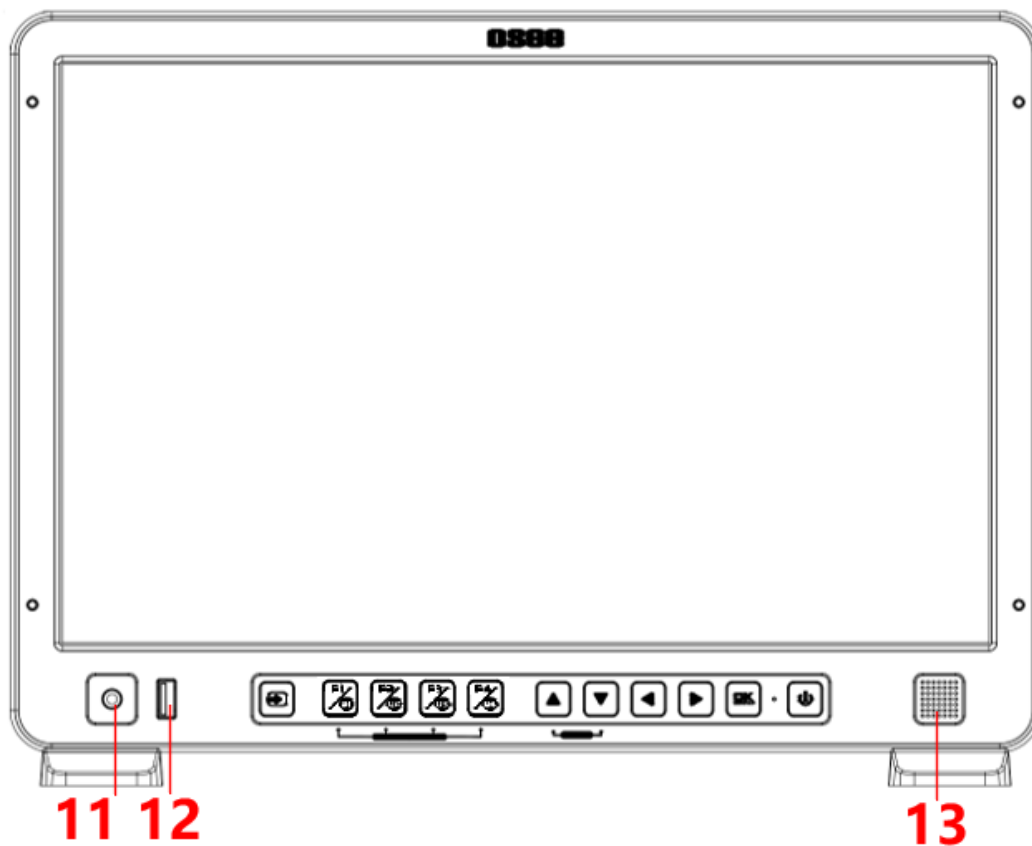

Figure 4.2-2 The Front Panel of MEGAMON 15 Monitor



The interfaces numbered in red are described as follows:

- |                           |                         |
|---------------------------|-------------------------|
| 1. Batt IN                | 8. HDMI Input: HDMI IN  |
| 2. AC Power Switch        | 9. REMOTE               |
| 3. AC IN                  | 10. Audio Input: AUD IN |
| 4. Video Input: SDI1 IN   | 11. Headphone           |
| 5. Video Input: SDI2 IN   | 12. USB                 |
| 6. Video Output: SDI1 OUT | 13. Speaker             |
| 7. Video Input: VIDEO IN  |                         |

### 4.2.2 Operations of Rear Panel

The details of these interfaces at the rear panel are described as follows:

#### 1. DC Battery IN: Batt IN (XLR 3pin)

It provides one DC battery power input interface, the specification is 11~17V3A DC.

#### 2. AC Power Switch

It provides one AC power switch to switch on or switch off. As shown in Figure 4.2-3, push the button to the direction “-” to switch on the power, or push the button to the direction “O” to switch off the power.



**Figure 4.2-3 Power Switch**

#### 3. AC Power Input: AC IN

It provides one AC power input interface, the specification is 100~240V50/60HzAC.

### Tips

- The power indicator is on the power button at the front panel. If the light is green, the monitor is powered on, and if the light is red, the monitor is standby.

**Warning**

- Only use the adapter and the power cord specified by the manufacture for your safety!

4. Video Input Interface (BNC) SDI1 IN~SDI2 IN

It provides two SDI input interfaces, labeled as **SDI1 IN, SDI2 IN**.

5. Video Output Interface (BNC) SDI1 OUT

It provides one SDI output interface, labeled as **SDI1 OUT**.

6. Video Input(BNC): VIDEO IN

7. HDMI Input: HDMI IN

It provides one HDMI input interface, HDMI Type-A connector with a fastener.

8. REMOTE(2.5mm jack)

It provides one TSL remote interface. Support for IMD remote control.

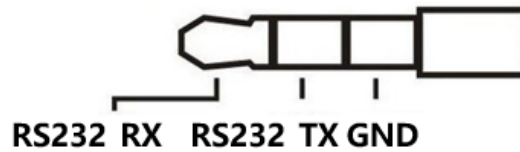

**Figure 4.2-4 Remote Interface**

9. Audio Input(3.5mm jack): AUD IN, it provides one audio input interface.

10. Audio Output(3.5mm jack): it provides one headphone.

11. USB: it is used for LUT input and firmware upgrading.

### 4.3 Supported Signal Format

The supported signal format for this device is as shown in Table 4.3-1:

**Table 4.3-1 Supported Signal Format**

Signal	SDI	HDMI	VIDEO
NTSC			✓

Signal			SDI	HDMI	VIDEO
PAL					✓
SD	480I60	4:2:2 YCbCr 10 BIT	✓		
	576I50		✓		
HD	720P24/23.98		✓		
	720P25		✓		
	720P30/29.97		✓		
	720P50		✓	✓	
	720P60/59.94		✓	✓	
	1080SF24/23.98		✓	✓	
	1080SF25		✓	✓	
	1080SF29.97		✓	✓	
	1080SF30		✓	✓	
	1035I60/59.94		✓		
	1080I50		✓	✓	
	1080I60/59.94		✓	✓	
	1080P24/23.98		✓	✓	
	1080P25		✓	✓	
1080P30/29.97	✓		✓		
3G	1080I50		4:2:2 YCbCr 12 BIT	✓	
	1080I60/59.94	4:4:4 YCbCr 10 BIT	✓		
	1080P24/23.98	4:4:4 YCbCr 12 BIT	✓		
		4:4:4 RGB 10 BIT	✓		
	1080P25	4:4:4 RGB 12 BIT	✓		
	1080P30/29.97	4:4:4_XYZ_10BIT	✓		
		4:4:4_XYZ_12BIT	✓		
1080P50	4:2:2 YCbCr 10 BIT	✓			
1080P60/59.94		✓			
3G-2K	1080SF24/23.98	4:2:2 YCbCr 12 BIT	✓		
	1080SF25	4:4:4 YCbCr 10 BIT	✓		
		4:4:4 YCbCr 12 BIT	✓		
	1080SF29.97	4:4:4 RGB 10 BIT	✓		
	1080SF30	4:4:4 RGB 12 BIT	✓		
4:4:4_XYZ_10BIT		✓			
1080P24/23.98	4:4:4_XYZ_12BIT	✓			

Signal		SDI	HDMI	VIDEO
	1080P25	✓		
	1080P30/29.97	✓		
	1080P48/47.95	✓		
	1080P50	✓		
	1080P60/59.94	✓		
		4:2:2 YCbCr 10 BIT		



The menu interface is divided into three parts:

### 1. First level menu

It contains the menu list of the MAIN menu. Press **UP** or **DOWN** to access the corresponding menu item.

### 2. Second level menu

Press right arrow button to enter into the second level of menu list, as shown in Figure 5.1-2, it lists the title, the sub-menu items and the value of the item. Then, press **arrow** buttons and **OK/MENU** button to modify the value of the sub-menu.

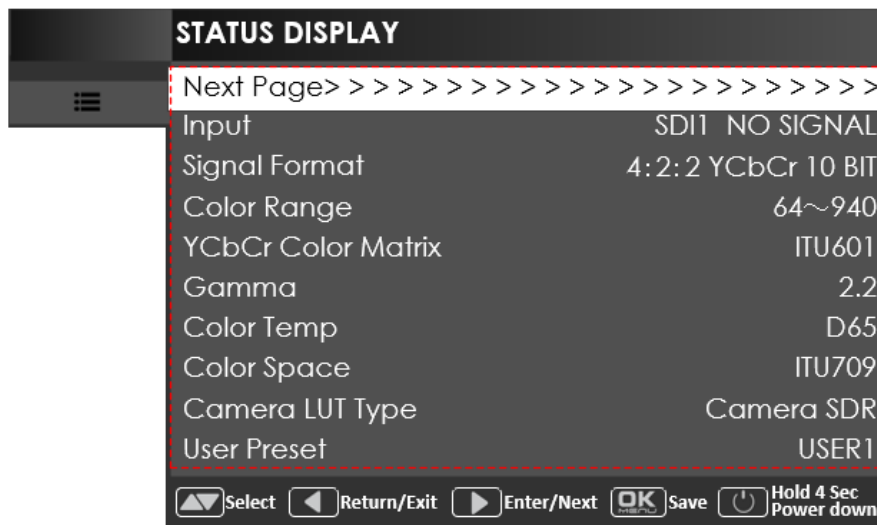

**Figure 5.1-2 the Second Level Menu**

#### ■ Control Icon

There is a white control icon when you select the menu or its value in the sub-menu list.

#### ■ Next Page Selection

There is a white control icon when you select the menu or its value in the sub-menu list.

When there are more than one page items in a menu list, there will be a **Next Page** item at the first line in every pages. Press right arrow button or press the **OK/MENU** button to turn page.

### Tips

- The sub-menu item is selected when the control icon which is in white highlight is at the back of the item name.

The following will introduce the contents and functionality of these sub-menu items in sorts.

### 5.1.1 STATUS Menu

The STATUS menu items are used to describe the current status information of the monitor, the menu items are as shown in Figure 5.1-3:

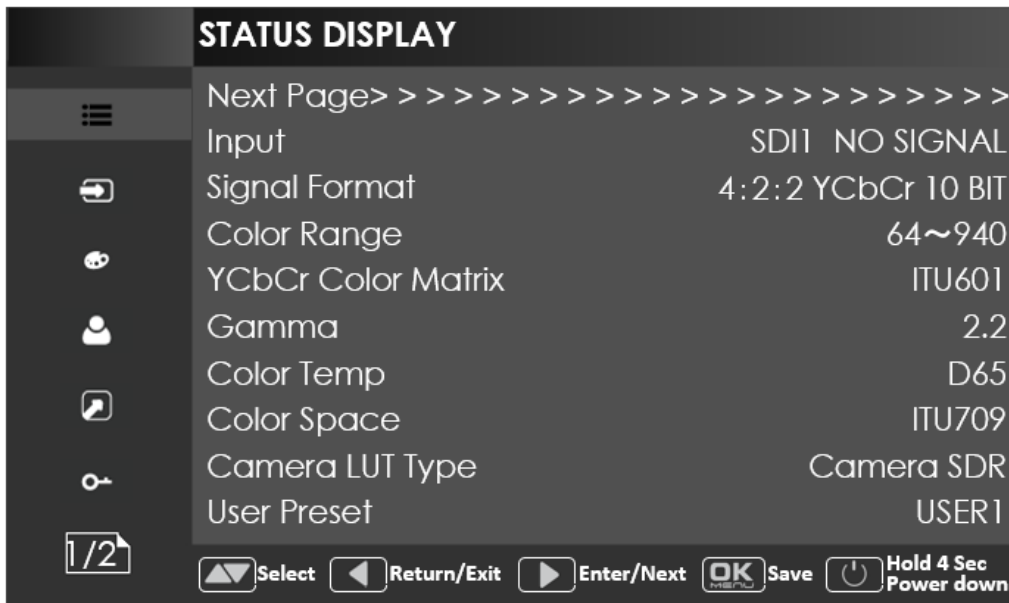

Figure 5.1-3 STATUS Menu

There are two pages in **STATUS** menu. The relationship of Items, Default Value, Domain Range and Description of the sub-item is shown in Table 5.1-1:

Table 5.1-1 The Description of STATUS Menu Items

Items	Default Value	Description
Page1		
Input	SDI1 1080I50	Show the input interface and its format
Signal Format	4:2:2 YCbCr 10 BIT	Show the format of the input signal
Color Range	64~940	Show current color range
YCbCr Color Matrix	ITU-R BT.709	Show YCbCr color matrix
Gamma	2.2	Show Gamma
Color Temp	D65	Show color temperature
Color Space	P3	Show color space

Items	Default Value	Description
Camera LUT Type	Camera SDR	Show the type of camera LUT
User Preset	USER1	Show the user preset name
Page2		
Model	--	Show the production model.
Serial Number	--	Show the serial number.
Firmware Version	--	Show the firmware number.

### Tips

- The sub-menu values in **STATUS** menu can't be modified, they display the actual status of the monitor.

## 5.1.2 INPUT CONFIG Menu

The INPUT CONFIG menu items are used to set the source of the input signals, the menu items are as shown in Figure 5.1-4:



**Figure 5.1-4 INPUT CONFIG Menu**

There is one page in **INPUT CONFIG** menu. The relationship of Items, Default Value, Domain Range and Description of the sub-item is shown in Table 5.1-2:

**Table 5.1-2 The Description of INPUT CONFIG Menu Items**



Items	Default Value	Domain Range	Description
Page1			
SDI IN1	ON	ON/OFF	Enable/Disable SDI1 input
SDI IN2	ON	ON/OFF	Enable/Disable SDI2 input
VIDEO	ON	ON/OFF	Enable/Disable VIDEO input
HDMI	ON	ON/OFF	Enable/Disable HDMI input
NTSC Phase	0	-50~50	Set the NTSC phase level, and this item is available only when NTSC format signal is input.
Signal Format	Auto	As shown in Table 5.1-3	signal format for the inputs
Color Range	64 ~ 940	<ul style="list-style-type: none"> <li>• 64~940</li> <li>• 64~1023</li> <li>• 0~1023</li> </ul>	Set color range
YCbCr Color Matrix	Auto	<ul style="list-style-type: none"> <li>• Auto</li> <li>• ITU-R BT.709</li> <li>• ITU-R BT.2020</li> </ul>	Set YCbCr color matrix

### 1. Signal Format Setting

The device provides four inputs: SDI IN1, SDI IN2. Set the input format through **INPUT CONFIG** → **Signal Format** menu item.

**Table 5.1-3 The Relationship of Signal Format and Signal Type**

Signal Type	SDI	HDMI
Signal Format	AUTO 4:2:2 YCbCr 10 BIT 4:2:2 YCbCr 12 BIT 4:4:4 YCbCr 10 BIT 4:4:4 YCbCr 12 BIT 4:4:4 RGB 10 BIT 4:4:4 RGB 12 BIT 4:4:4 XYZ 10 BIT 4:4:4 XYZ 12 BIT	AUTO 4:4:4 XYZ 10/12 BIT

### 5.1.3 COLOR MANAGEMENT Menu

The COLOR MANAGEMENT menu items are used to adjust the color temperature parameters and the color balance, the menu items are as

shown in Figure 5.1-5:



**Figure 5.1-5 COLOR MANAGEMENT Menu**

There are two pages in **COLOR MANAGEMENT** menu. The relationship of Items, Default Value, Domain Range and Description of the sub-item is shown in Table 5.1-4:

**Table 5.1-4 The Description of COLOR MANAGEMENT Menu Items**

Items	Default Value	Domain Range	Description
Page1			
Camera LUT	ON	ON/OFF	Enable/disable camera LUT
Camera LUT Type	Camera SDR	<ul style="list-style-type: none"> <li>• Camera SDR</li> <li>• Camera HDR</li> <li>• User</li> </ul>	Set a LUT from the corresponding list
Camera SDR	2.2	Refer to Table 5.1-5	Load the selected SDR LUT
Camera HDR	---	Refer to Table 5.1-5	Load the selected HDR LUT
User	User1	User1~User16	Load a customized LUT file
Load LUT File	---	---	To load a LUT file from the U disk
Page2			
Gamma	2.2	1.8/2.2/2.4/2.6/2.8/ BT.1886/PQ/HLG	Adjust Gamma
Color Temp	D65	D93/D65/D61/D55/	Set the color temperature

Items	Default Value	Domain Range	Description
		DCI/USER1/USER2	
Red Gain	512	0~512	Adjust the Red Gain
Green Gain	512	0~512	Adjust the Green Gain
Blue Gain	512	0~512	Adjust the Blue Gain
Copy From	D65	D93/D65/D61/D55/DCI	Copy this parameter value to USER
Reset	--	--	Reset the Gain and Offset values to the product originals
Color Space	EBU	<ul style="list-style-type: none"> <li>• Native</li> <li>• SMPTE-C</li> <li>• EBU</li> <li>• ITU709</li> <li>• ITU2020</li> <li>• P3</li> </ul>	Set the color space for the first channel

### 1. Camera LUT

MEGAMON 15 supports multiple camera LUTs, as shown in Table 5.1-5:

**Table 5.1-5 The Relationship Between EOTF and HDR**

Camera LUT	LUT Name	Company
SDR	ARRI_LogC_Rec709	ARRI
	BMD_4.6KFilm_Rec709	BlackMagic
	BMD_4.6KFilmV3_Rec709	
	BMD_4KFilm_Rec709	
	BMD_4KFilmV2_Rec709	
	BMD_4KFilmV3_Rec709	
	BMD_CCFilm_Rec709	
	BMD_CCFilmV2_Rec709	
	Canon_CLog1Cine_Rec709_FF_V1.1	Canon
	Canon_CLog2Cine_Rec709_FF_V1.1	
	Canon_CLog3Cine_Rec709_FF_V1.1	
	DJI_Phantom3DLog_Rec709_Improv	DJI
	DJI_Phantom4DLog_Rec709	
	DJI_Phantom4Dlog_Rec709_Improv	

Camera LUT	LUT Name	Company
	DJI_X5DLog_Rec709_Improv	
	FUJI_FLogFGamut_FLogRec709_V1	FUJIFILM
	FUJI_FLogFGamut_WDRRec709_V1	
	GoPro_Protune_Rec709	GoPro
	JVC_JLog1_Rec709_Daylight	JVC
	JVC_JLog1_Rec709_Tungsten	
	Panasonic_VLog_V709_V1	Panasonic
	RED_L3G10RWG_Rec709_R1_V1.13	RED
	RED_L3G10RWG_Rec709_R2_V1.13	
	RED_L3G10RWG_Rec709_R3_V1.13	
	RED_L3G10RWG_Rec709_R4_V1.13	
	RED_RedLogFilm_RG3	
	Sony_SLog2SGamut_LCRec709	Sony
	Sony_SLog2SGamut_LCRec709A	
Sony_SLog3SG3Cine_LCRec709		
Sony_SLog3SG3Cine_LCRec709A		
HDR	ARRI_LogC_HLG_Rec2020	Osee
	ARRI_LogC_PQ_Rec2020	
	Canon_Clog2Cin_HLG_Rec2020	
	Canon_Clog2Cin_PQ_Rec2020	
	Canon_Clog3Cin_HLG_Rec2020	
	Canon_Clog3Cin_PQ_Rec2020	
	Panasonic_VLog_HLG_Rec2020	
	Panasonic_VLog_PQ_Rec2020	
	RED_L3G10_HLG_Rec2020	
	RED_L3G10_PQ_Rec2020	
	Sony_SLog3_Cin_HLG_Rec2020	
	Sony_SLog3_Cin_PQ_Rec2020	
	Sony_SLog3_SG3_HLG_Rec2020	
	Sony_SLog3_SG3_PQ_Rec2020	

When setting **Camera LUT Type** item as **Camera SDR**, **Camera HDR**

or **User**, the following corresponding **Camera SDR**, **Camera HDR**, **User** item will be activated, and the available ranges of Gamma are diverse, as shown in the following table:

Camera LUT Type	Gamma
Camera SDR	1.8/2.2/2.4/2.6/2.8/BT.1886
Camera HDR	PQ/HLG
User or OFF	1.8/2.2/2.4/2.6/2.8/BT.1886/PQ/HLG

## 2. Load a user LUT from disk

First, load a LUT file to the designated user LUT. Set **COLOR Management**→ **Load LUT File**, it will pop up the **USB LUT Files** selection window as shown in Figure 5.1-6. Select **USER** item, and when detecting USB disk, it will pop up a file selection window, press the arrow button to select a LUT file, press **OK/MENU** button to confirm the selection, and it will pop up a USER file selection window, press the arrow button to choose from **User1~ User16** to set the storage path for the selected LUT. For example, select **User1**, and press **OK/MENU** button to confirm the setting.

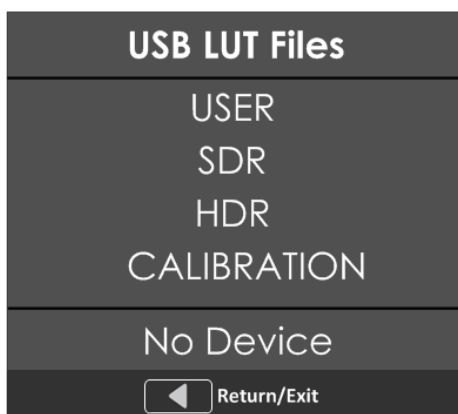

**Figure 5.1-6 USB LUT Files**

Second, power off the device, and restart it to affect the settings above.

At last, set **COLOR Management**→ **Camera LUT** as **User** item, and set **COLOR Management**→ **User** as **User1** selected as above. The LUT file will take effect.

## Tips

- Make sure to restart the device to effect the selected user LUT file after loading it to a designated user LUT through the USB disk.
- The items about RED/GREEN/BLUE GAIN are available only in USER1 and USER2 mode. If the COLOR TEMP is set to **USER1** or **USER2** with

customized settings, you can select the menu item **COLOR TEMP→RESET** command to restore product originals for Gains, and press **OK/MENU** button to confirm the reset operation.

### 5.1.4 USER CONFIG Menu

The USER CONFIG menu items are used to adjust the parameters defined by customers, the menu items are as shown in Figure 5.1-7:

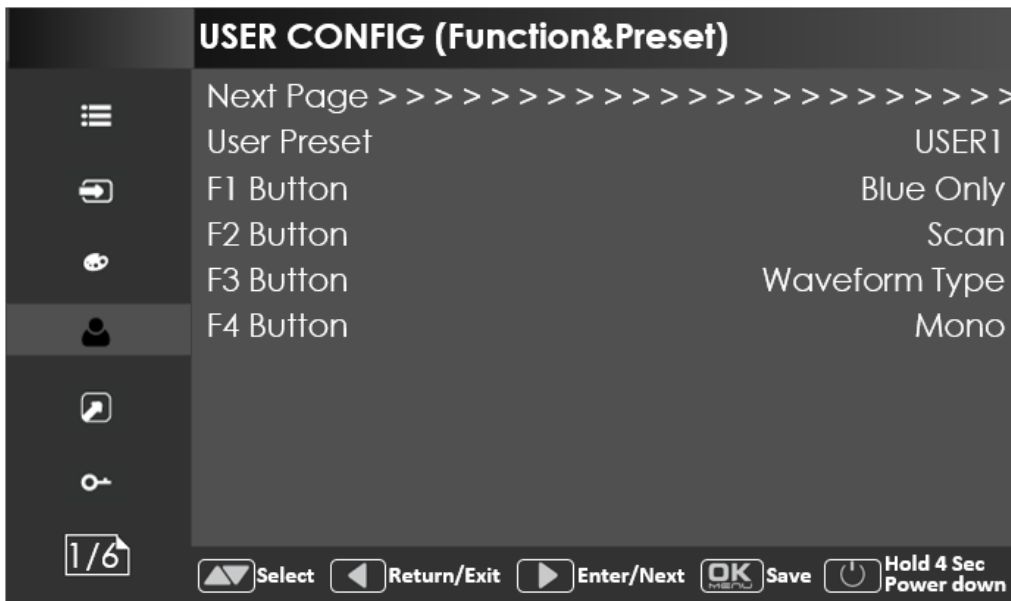

**Figure 5.1-7 CONFIG Menu**

There are six pages in **USER CONFIG** menu. The relationship of Items, Default Value, Domain Range and Description of the sub-item is shown in Table 5.1-6:

**Table 5.1-6 The Description of USER CONFIG Menu Items**

Items	Default Value	Domain Range	Description
Page1			
User Preset	USER1	USER1/USER2/ USER3/USER4	Set the settings as a user preset
F1 Button	Scan	Camera LUT/Undef/ Blue Only/Mono/ Marker/Audio Meter/ Time Code/	Assign a function to F1 button

Items	Default Value	Domain Range	Description
		Waveform Type/ Vectorscope/Histogram/ Scan/ Native/ Aspect(Anamorphic)/ Mute/IMD Display/ False Color/ Focus Assist/ Peak/Zebra	
F2 Button	Marker	the same as F1	Assign a function to F2 button
F3 Button	Audio Meter	the same as F1	Assign a function to F3 button
F4 Button	Blue Only	the same as F1	Assign a function to F4 button
Page2			
Audio Source	EBD	<ul style="list-style-type: none"> <li>EBD: embedded signal</li> <li>EXT: external signal</li> <li>OFF: no signal</li> </ul>	Select the audio source.
Speak Out L	EBD CH1	When the audio source is EBD, the range of this item is EBD CH1~EBD CH16.	Left speaker, select a channel according to the type of audio source.
Speak Out R	EBD CH2	When the audio source is EBD, the range of this item is EBD CH1~EBD CH16.	Right speaker, select a channel according to the type of audio source.
Meter Display	OFF	OFF/ON	Set whether to display the audio meter.
Meter Select	CH1-2	CH1-2/ G1/G2/G3/G4/ G1+G2/G1+G3/ G1+G4/G2+G3/ G2+G4G3+G4/ G1-G4	Select a meter display mode. Each G* contains four channels, and each CH* means a channel with number.
Meter Position	LEFT	LEFT/RIGHT	Select the displayed position of audio meter.
Display Mode	Mode1	Mode1: simple audio meter Mode2: audio meter with channel number	Used to set the displayed mode for audio meter.

Items	Default Value	Domain Range	Description
		and frame	
Meter Opacity	0	<ul style="list-style-type: none"> <li>0: 100%</li> <li>1: 50%</li> </ul>	Set the transparency for audio meter.
Page 3			
Marker	OFF	OFF/ON	Set whether to show all of the markers. It is the main switch for area marker, center marker and safety marker.
Aspect Marker	OFF	<ul style="list-style-type: none"> <li>16:9</li> <li>4:3</li> <li>15:9</li> <li>14:9</li> <li>13:9</li> <li>1.85:1</li> <li>2.35:1</li> <li>Variable</li> <li>OFF</li> </ul>	Select the aspect marker according to the display aspect ratio.
Variable Aspect	3.00	1.00 ~ 3.00, the step is 0.01	When set the Aspect Marker as Variable, set the aspect ratio at this item
Center Marker	OFF	OFF/ON	Set whether to show the center marker
Area Marker	OFF	<ul style="list-style-type: none"> <li>OFF</li> <li>80%</li> <li>85%</li> <li>88%</li> <li>90%</li> <li>93%</li> <li>95%</li> </ul>	Set the safety area size according to the aspect ratio and scan mode.
Marker Fit	OFF	<ul style="list-style-type: none"> <li>OFF: the safety marker is based on the current input source</li> <li>ON: the safety marker is based on the image within the current aspect marker</li> </ul>	Whether to set connection between Aspect MARKER and Safety Marker.
Marker Level	1	<ul style="list-style-type: none"> <li>1: 50%</li> <li>2: 75%</li> </ul>	Set the luminance of marker line, including



Items	Default Value	Domain Range	Description
		<ul style="list-style-type: none"> <li>3: 100%</li> </ul>	safety marker, center marker, area marker and cross hatch.
Marker Mat	OFF	<ul style="list-style-type: none"> <li>OFF: Normal background, use line for area marker edge only</li> <li>HALF: 50% Background brightness</li> <li>BLACK: all black</li> </ul>	Darkens the outside of the area of the Aspect Marker, and set its transparency.
Cross Hatch	OFF	OFF/ON	Set whether to show the cross hatch.
Page 4			
Waveform Type	OFF	<ul style="list-style-type: none"> <li>WAVEFORM</li> <li>VECTOR</li> <li>WFM WIDE</li> <li>HDR WFM</li> <li>OFF</li> </ul>	Set the display type of WFM
Waveform Size	Small	Small/Middle/Large	Set the waveform display size
Waveform Location	TOP RIGHT	<ul style="list-style-type: none"> <li>Small: Left Up/Center Up/Right Up/Right Center/Right Down/Center Down/Left Down/Left Center</li> <li>Middle: Right Down/Center Down/Left Down</li> <li>Small: Center Down</li> </ul>	Set the location of the waveform
Vectorscope	OFF	OFF/ON	Enable/Disable vectorscope display
Vectorscope Location	TOP RIGHT	<ul style="list-style-type: none"> <li>Left Up</li> <li>Center Up</li> <li>Right Up</li> <li>Right Center</li> <li>Right Down</li> <li>Center Down</li> <li>Left Down</li> <li>Left Center</li> </ul>	Set the location of the vectorscope

Items	Default Value	Domain Range	Description
Histogram	OFF	OFF/LUMA/RGB	Enable/Disable histogram display, and set the histogram mode
Histogram Location	TOP RIGHT	<ul style="list-style-type: none"> <li>• Left Up</li> <li>• Center Up</li> <li>• Right Up</li> <li>• Right Center</li> <li>• Right Down</li> <li>• Center Down</li> <li>• Left Down</li> <li>• Left Center</li> </ul>	Set the location of the histogram
Opacity	0	<ul style="list-style-type: none"> <li>• 0: 100%(opaque)</li> <li>• 1: 75%</li> <li>• 2: 50%</li> <li>• 3: 25%</li> </ul>	Set the transparency of WFM, vectorscope and histogram
Page 5			
Focus Assist	OFF	<ul style="list-style-type: none"> <li>• OFF</li> <li>• GRAY: Turn the image into gray mode, and displays the edge of images with color selected in FOCUS COLOR.</li> <li>• COLOR: Displays the edge of images with color selected in FOCUS COLOR.</li> </ul>	Enable/Disable the focus assist function, and set focus assist mode. When the difference of the edges exceeds the reference value (FOCUS LEVEL), the edge detected will be in colorful feature set by FOCUS COLOR.
Focus Assist Color	Red	Red/Green/Blue	Set the color for the detected edge of images.
Focus Assist Level	50	0~100	Set the edge difference value between the edges in an image, and take this value as the reference value. Larger value means more detail detection.
Peak	OFF	ON/OFF	Enable/Disable peak function. Over sharpen the image.
Peak Level	1	1~8	Set the sharpness level of the image. The



Items	Default Value	Domain Range	Description
			higher the value, the sharper the image.
False Color	OFF	OFF/ON	Enable/Disable false color function
False Color Type	Spectrum	Spectrum/SONY Slog3/ SONY Slog2/ARRI LogC/ Canon Clog2/ Canon Clog3/ Panasonic Vlog/ RED RedLogFilm/ RED RL3G10/ BMD/BMD 4K/ ARRI Rec709/ SONY LC709A/ SONY LC709/ Panasonic V709/ RED G3/RED G4	Set the type of the false color display
Zebra	OFF	ON/OFF	Enable/Disable the zebra function that will compare the signal luminance with the ZEBRA LEVEL, and fill the relevant image area whose luminance is higher than the ZEBRA LEVEL with a zebra pattern.
Zebra Level	50	0~100	Set the reference level of detecting luminance.
Page 6			
Internal Signal	OFF	OFF/ON	Enable/Disable the internal color bar
OSD Time	ON	ON/10s/30s/60s	Set the display time of the OSD menu
Time Code	OFF	OFF/ON	Enable/Disable time code display
Status Display	OFF	OFF/ON/AUTO/BAT	Set the display time of the Status information menu
Language	ENGLISH	ENGLISH/中文	Select a language

Items	Default Value	Domain Range	Description
			mode
Monitor Reset	--	--	Set whether to restore the factory settings
Firmware Upgrade	--	--	Upgrade the firmware

#### 5.1.4.1 FUNCTION KEY and User Preset Menu

##### 1. User Preset

The user preset provides a series of menu settings customized as a User Preset, up to 4 presets could be defined in this device.

Set **USER CONFIG**→**User Preset** as User1, User2, User3 or User4 to switch among these various preset settings for current menu display. Or press  ~  button and hold 2s to select the related user presets, and there will be a prompt displaying the current user preset name at the left center of the screen.

The FUNCTION KEY menu items(F1 Button~F4 Button) are used to assign function to the function key (F1~F4) on the front panel, and adjust the value of the function parameter. The menu items of FUNCTION KEY are as shown in **Table 5.1-7**:

**Table 5.1-7 Functionalities for the Function Key**

Items	Default Value	Range	Description
Camera LUT	OFF	OFF/ON	Enable/Disable Camera LUT
Blue Only	OFF	OFF/Red/Green/Blue	Enable/Disable blue only
Mono	OFF	OFF/ON	Enable/Disable Mono
Marker	OFF	OFF/ON	Enable/Disable the master marker switch
Audio Meter	OFF	OFF/ON	Enable/Disable audio meter display
Time Code	OFF	OFF/ON	Enable/Disable time code display
Waveform Type	OFF	LUMA/RGB/PARADE/OFF	Set the waveform type
Vectorscope	OFF	OFF/ON	Enable/Disable Vectorscope display

Items	Default Value	Range	Description
Histogram	OFF	OFF/LUMA/RGB	Enable/Disable Histogram display
Scan	OFF	Normal/Over	Enable/Disable scan function
Aspect	---	As shown in Table 5.1-8	Set aspect ratio
Native	OFF	OFF/Left/Center/Right	Enable/Disable native function, and set its mode
Mute	OFF	OFF/ON	Enable/Disable mute
IMD Display	OFF	OFF/ON	Enable/Disable IMD display
False Color	OFF	OFF/ ON	Enable/Disable false color function
Focus Assist	OFF	OFF/Mono/ Focus Assist Color	Enable/Disable Focus Assist function and set its mode
Peak	OFF	OFF/ON	Enable/Disable Peak
Zebra	OFF	OFF/ON	Enable/Disable Zebra

## 2. ASPECT

Set the aspect ratio of the screen, it is different from the formats of the input signals, and the details are as shown in **Table 5.1-8**:

**Table 5.1-8 The Relationship of Input Signal Formats and Its Aspects**

Input Signal	Default	Value Range	Input Signal Formats	
SD	4:3	<ul style="list-style-type: none"> <li>4:3</li> <li>16:9</li> </ul>	480I60 576I50	
HD	16:9	<ul style="list-style-type: none"> <li>16:9</li> <li>2.39:1</li> </ul>	720P24/23.98 720P25 720P30/29.97 720P50 720P60/59.94 1080SF24/23.98 1035I60/59.94	1080I50 1080I60/59.94 1080P24/23.98 1080P25 1080P30/29.97 1080P50 1080P60/59.94
2K	1.896:1	<ul style="list-style-type: none"> <li>1.896:1</li> <li>2.39:1</li> </ul>	2048X1080PSF24/23.98 2048X1080PSF25 2048X1080PSF30/29.97 2048X1080P24/23.98 2048X1080P25	2048X1080P30/29.97 2048X1080P48/47.95 2048X1080P50 2048X1080P60/59.94

## 3. Anamorphic

This feature enables you to de-squeeze signals coming from camera

utilizing anamorphic lenses that may not have a built-in de-squeeze feature of their own. This is quite useful in applications, such as outdoor post production, onset monitoring, real-time de-squeezing, etc.

Select ANAMORPHIC item from these anamorphic ratios: 0.75X, 1X, 1.33X, 1.5X, 1.66X, 1.8X, 2X, 2XMAG.

The resolution of the input and output are as shown in Table 5.1-9:

**Table 5.1-9 The Relationship of Input Signal Formats and Its Ratio**

ANAMORPHIC	INPUT SIGNAL	INPUT	OUTPUT
1X	1080P/1080I	1920x1080	1920x1080
	720P	1280x720	1920x1080
1.33X	1080P/1080I	1920x1080	1920x812
	720P	1280x720	1920x812
1.5X	1080P/1080I	1920x1080	1920x720
	720P	1280x720	1920x720
1.66X	1080P/1080I	1920x1080	1920x650
	720P	1280x720	1920x650
2X	1080P/1080I	1920x1080	1920x540
	720P	1280x720	1920x540
2XMAG	1080P/1080I	1290x720	1920x803
	720P	860x720	1920x803

### Tips

- For various scenarios, this device offers ASPECT or Anamorphic function to change the picture size displayed in functions keys and the items. If you want change the selection, please contact your dealer or OSEE TECHNOLOGY LTD. for support.

#### 4. Mute

Active this function to adjust the volume to 0, press the function button again to release the volume to the last value.

#### 5. BLUE ONLY

It is to activate BLUE ONLY mode that will remove colors from the input signal and display the screen only under a red, green or blue signal, thus to observe the single channel of the input signal and adjust color accuracy.

#### 6. MONO

It is to activate MONO mode that will display the screen in monochrome presentation to adjust the contrast of the screen display, inactivate this mode to display the screen in color mode.

## **i Tips**

- Press F1~F4 button to activate the assigned function and adjust the parameter value.

### **5.1.4.2 Audio Menu**

The Audio menu items are displayed on Page2 in **USER CONFIG** menu, and they are used to adjust the audio parameters:

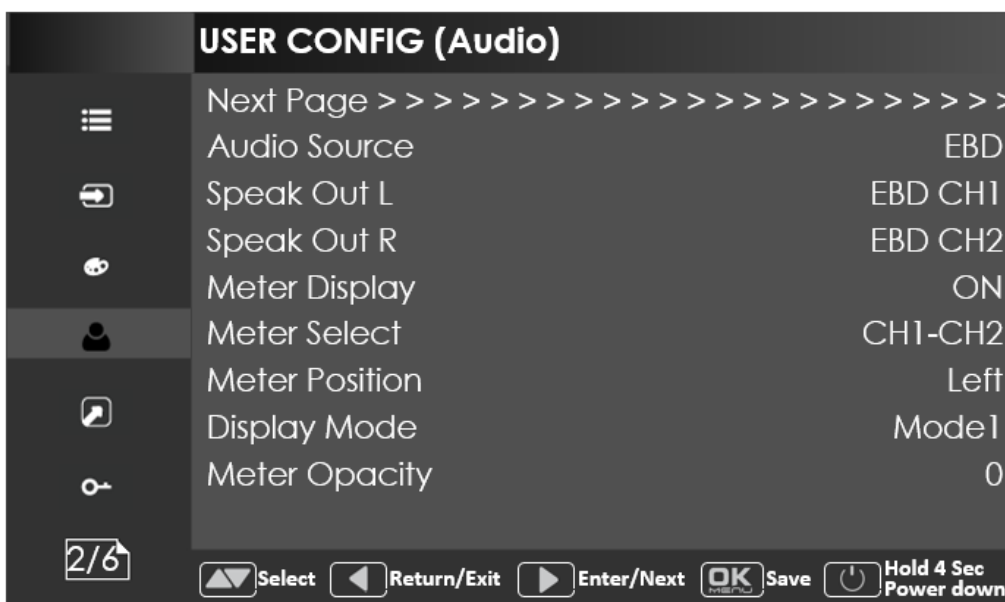

**Figure 5.1-8 CONFIG Menu-Page2**

The appearance of Meter is as shown in Figure 5.1-9:

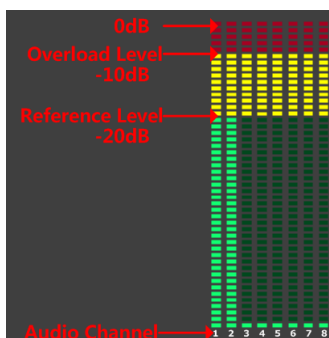

**Figure 5.1-9 Audio Meter**

## 1. Audio Meter Display Mode

**Meter Select** controls the amount of channels displayed in an audio meter, and each group(G\*) contains four channels. As shown in Figure 5.1-10, the meter displays at the left bottom of the screen vertically.

**For example:** the **Meter Select** is **G1+G2**, and the **Display Mode** is **Mode2**. There is a white rectangle frame with two white level lines in the meter, the upper is the over level line, and the lower is the reference level line. If the audio value is higher than the reference level, the audio bar over the reference level line will display yellow, and if the audio value is higher than the over level, the audio bar over the over level line will display red.



**Figure 5.1-10** The Position of the Audio Meter On Screen

## 2. Audio Meter Display Position

The position of Meter is controlled by **Meter Position** item, the position of the meter on the screen is as follows: **Left**, **Right**. For example, the illustrations of the positions are as shown in Figure 5.1-11:



**Figure 5.1-11** the Positions of Meter

## Tips

- The prerequisite for the available settings of the display mode and the position of audio meter is that the **Meter Display** is **ON**.



5.1.4.3 Marker Menu

The Marker menu items are displayed on Page3 in **USER CONFIG** menu, and they are used to adjust the marker parameters, the menu items are as shown in Figure 5.1-12:

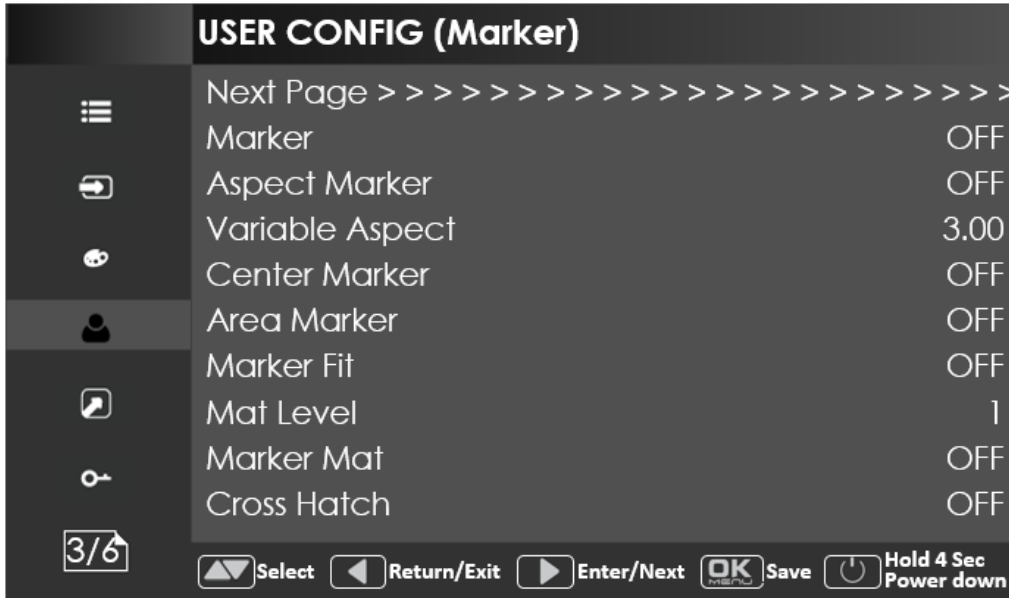

Figure 5.1-12 USER CONFIG Menu-Page3

1. Markers

Marker	Illustration	Description
Center Marker		This marker enables easier checking the center portion's focus.
Aspect Marker		This marker displays two lines to identify an area with a specified ratio.
Area Marker		This marker displays a rectangle to identify the safety area with a specified percentage.

Marker	Illustration	Description
Cross Hatch		This marker displays multiple vertical and horizontal lines to help when users check the composition of a picture.

## 2. MARKER MAT

The marker mat marks the outside area of the marker display with the appointed transparency.

For example, set **ASPECT** as 16:9, **Aspect Marker** as 4:3, and **Area Marker** as 95%, then, the comparison of the three **Marker Mats** are as shown in Figure 5.1-13:

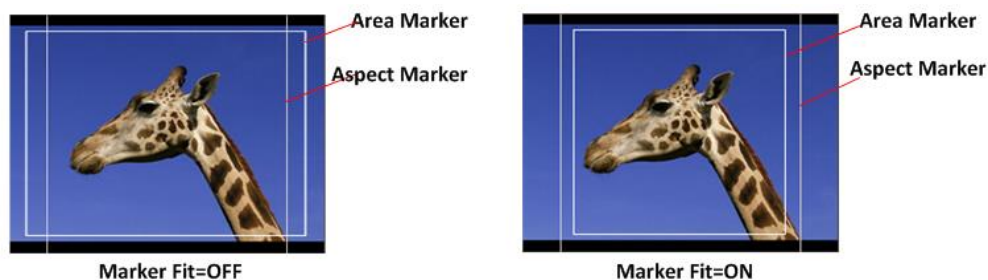

**Figure 5.1-13 MARKER MAT**

## 3. MARKER FIT

The **USER CONFIG** → **Marker Fit** item is used to whether set up the connection between area marker and safety marker.

Set **Marker Fit** item as OFF, the safety area is based on the whole current image display, while Set **Marker Fit** item as ON, the safety area is in the range of area marker, the comparisons are as shown in Figure 5.1-14



**Figure 5.1-14 MARKER FIT**

## Tips

- The **Aspect Marker**, **Center Marker** and **Area Marker** feature are

available only when the **Marker** item is set to **ON**.

- The safety marker area will change with the area marker when setting **Marker Fit** item to be **ON**.
- The cross hatch lines will display only in the single image or in PIP mode when **Cross Hatch** is **ON**.

**5.1.4.4 Scope Menu**

The Scope menu items are displayed on Page4 in **USER CONFIG** menu, and they are used to adjust the parameters displayed on the screen, the menu items are as shown in Figure 5.1-15:

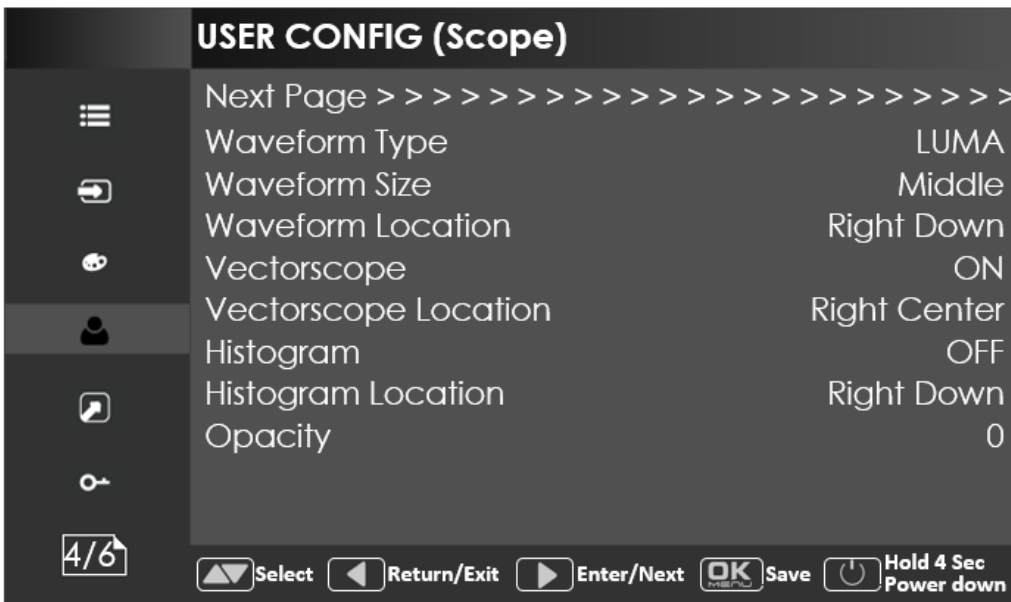

**Figure 5.1-15 USER CONFIG Menu-Page4**

**1. Display Location**

Set the location of waveform, vectorscope and histogram by **USER CONFIG** → **Waveform Location/ Vectorscope Location/ Histogram Location** separately, the available locations on the screen are as shown in Figure 5.1-16:

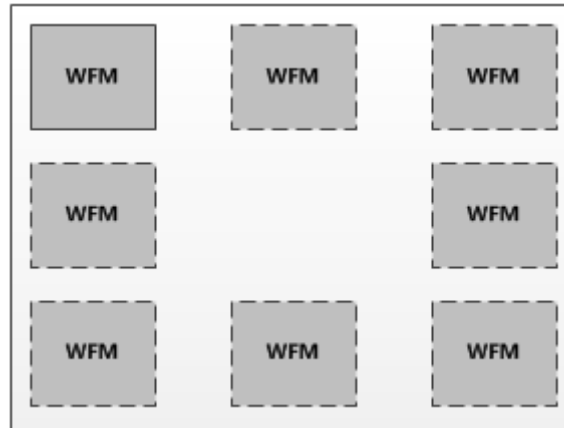
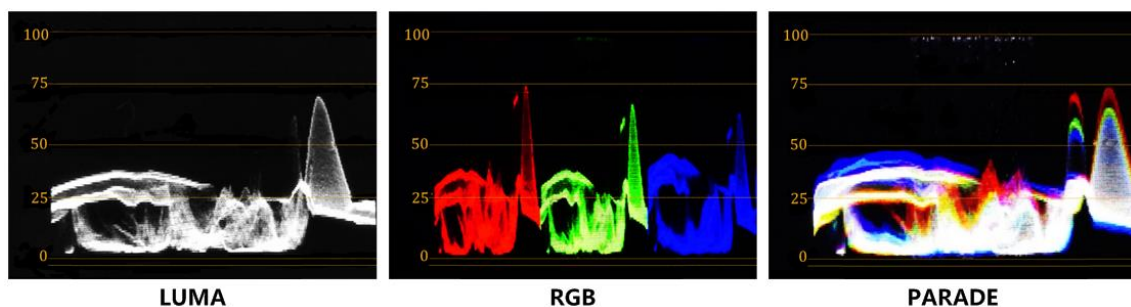

**Figure 5.1-16** *Display Location*

## 2. Waveform

### ■ Waveform Display Mode

Set various waveform through **USER CONFIG** → **Waveform Type** item, and display the following three kinds of waveform as LUMA, RGB, PARADE, shown in Figure 5.1-17:



**Figure 5.1-17** *LUMA Waveform and RGB Waveform and PARADE Waveform*

### ■ Waveform Size

Set **USER CONFIG** → **Waveform SIZE** item to adjust the size of the waveform, there are three kinds of sizes for waveform:

- Small size waveform: set **Waveform SIZE** item as **Small**, and this kind of waveform could be located in any one of the 8 positions listed in **LOCATION** item;
- 75% waveform: set **Waveform SIZE** item as **Middle**, and this kind of waveform is located in the bottom of the screen, and it can be moved;

- Full size waveform: set **Waveform SIZE** item as **Large**, and this kind of waveform is located in the bottom of the screen, and it can't be moved.

**3. Vectorscope**

Set **USER CONFIG** → **VECTORSCOPE** item to display or hide the vectorscope.

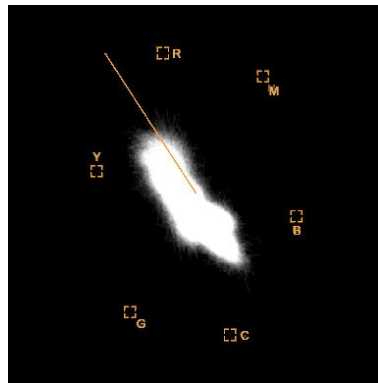

**Figure 5.1-18 VECTORSCOPE**

**4. Histogram**

Histogram assists in judging the distribution of luminance in the image.

■ **Histogram Type**

Set **USER CONFIG** → **HISTOGRAM** item to open or close the histogram display, and set the histogram display mode as LUMA or RGB, the two histogram types are as shown in Figure 5.1-19:

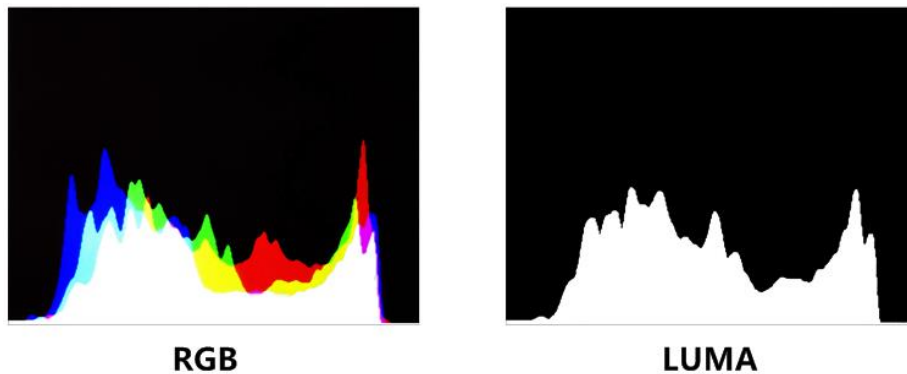

**Figure 5.1-19 RGB Histogram and LUMA Histogram**

**5.1.4.5 Focus and Exposure Menu**

There are some assistant settings on Page5 in **USER CONFIG** menu, they are zebra, focus assist, peak and false color.

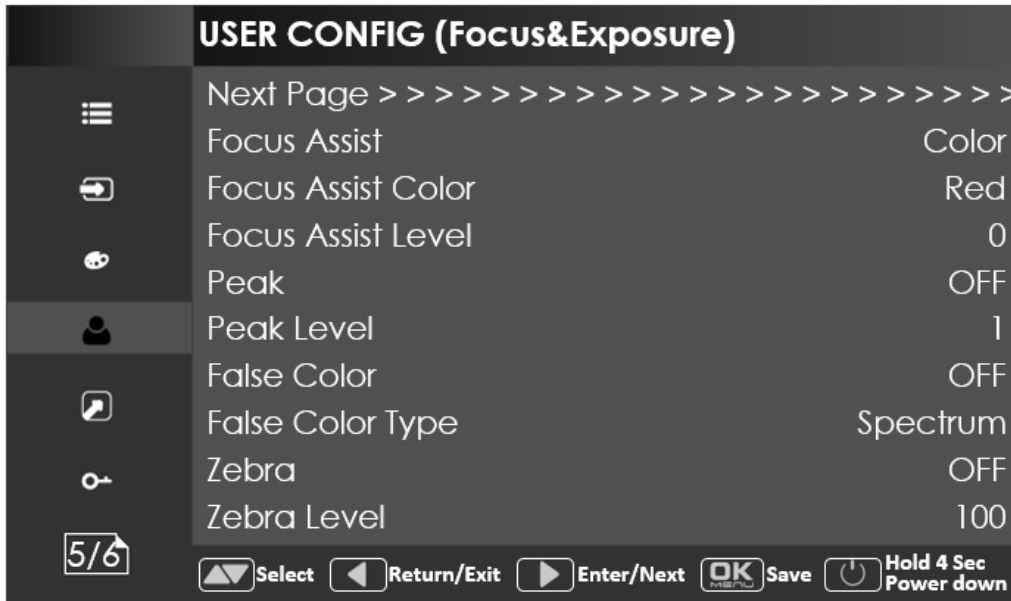

Figure 5.1-20 USER CONFIG Menu-Page5

### 1. Focus Assist

The FOCUS ASSIST function is used to display images on the screen with intensified edge to help camera focus operation.

Set **USER CONFIG** → **Focus Assist** item to enable the focus assist function. The intensified edges are those areas whose difference value exceeds the reference focus level (**SENSITIVITY**), and the intensified edge are displayed in the designated color set by **Focus Assist Color**.

#### ■ FOCUS ASSIST MODE

- Color Mode:** Set **USER CONFIG** → **Focus Assist** item as **Color**, the image is in color mode, then set **USER CONFIG** → **Focus Assist Color** to color the intensified edge.
- Gray Mode:** Set **USER CONFIG** → **Focus Assist** item as **Mono**, the image is in black and white mode, that is removing all colors and only leaving the luminance data of the signal.



**Focus Assist=Color**  
**Focus Assist Color=Red**



**Focus Assist=Color**  
**Focus Assist Color=Green**



**Figure 5.1-21 Illustration for FOCUS ASSIST Function**



**Focus Assist= Mono**

**Figure 5.1-22 Illustration for FOCUS ASSIST Function**

**2. FALSE COLOR-Exposure Assist**

FALSE COLOR is also known as EXPOSURE ASSIST, this function generates an artificial luminance map of the input signal that can be useful to identify over exposed areas(exposure). This is a quick way to gauge the exposure levels of an image in a clear way.

Choose the **False Color** tool to activate the FALSE COLOR function. It provides multiple types of FALSE COLOR types: Spectrum, SONY Slog3, SONY Slog2, ARRI LogC, Canon Clog2, Canon Clog3, Panasonic Vlog, RED RedLogFilm, RED RL3G10, BMD, BMD 4K, ARRI Rec709, SONY LC709A, SONY LC709, Panasonic V709, RED G3, RED G4.

**For example:** Set **USER CONFIG** →**False Color** item as **ON** and **False Color Type** item as **ARRI LogC**, as shown in Figure 5.1-23:



**FALSE COLOR=OFF**



**FALSE COLOR=ON**

**Figure 5.1-23 Comparison Mode- Original Image and Normal Mode Image**

**3. ZEBRA**

The **ZEBRA** function is used to display images on the screen with a zebra pattern to adjust the camera exposure parameter. It will compare the signal luminance with the **Zebra Level**, and fill the relevant image area

whose luminance is higher than the **Zebra Level** with a zebra pattern.

**For example**, set the **Zebra Level** as 80, the compared results are as shown in **Figure 5.1-24**, the special area is filled with a zebra pattern.

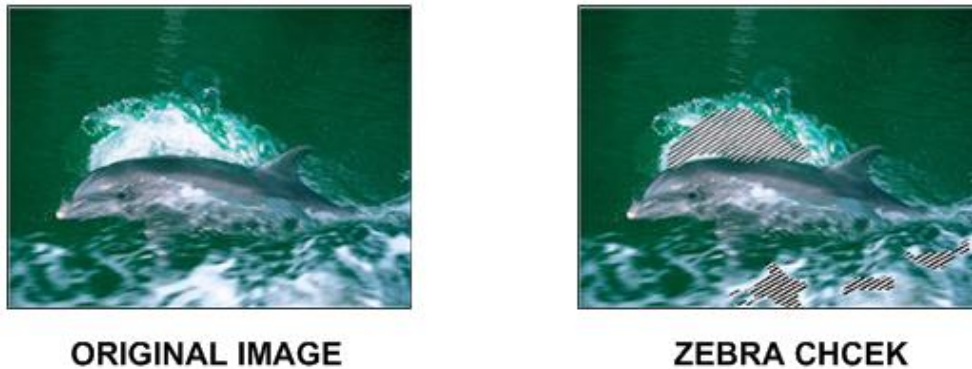

**Figure 5.1-24** Illustration for LUMA ZOOM CHECK Function

**5.1.4.6 Other Menu**

There are some system settings on Page6 in **USER CONFIG** menu.

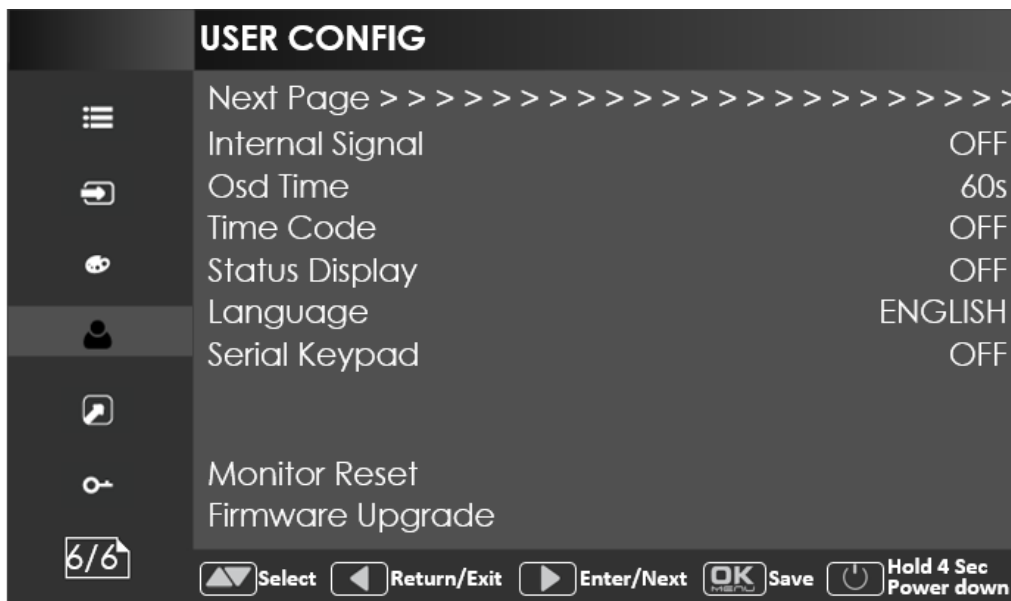

**Figure 5.1-25** USER CONFIG Menu-Page7

**1. Internal Signal**

Set **USER CONFIG**→ **Internal Signal** item as ON, it will display the color test pattern on the screen.

**2. Osd Time**

Set **USER CONFIG**→**Osd Time** as 10s, 30s or 60s. After you have loaded the menu, it will be closed automatically if you do nothing operation within the OSD Time.



**3. Time Code**

Select **USER CONFIG** → **Time Code** item to enable the display of embedded timecode on screen, only valid for SDI input signal.

Timecode is displayed as the format of “HH:MM:SS:FF” at the bottom center of the screen, and if there is no available timecode, it will not appear.



*Figure 5.1-26 Timecode*

**4. Status Display**

Set **USER CONFIG** → **Status Display** item as ON, the status menu will be displayed in the top left corner of the screen, and it includes the input channel, signal format and battery indicator.



*Figure 5.1-27 Status Menu*







**Settings:**

- ON:** display the input channel, signal format and battery indicator (available only when the battery level higher than 10.5V);
- OFF:** turn off the display of the input channel, signal format and battery indicator;
- BAT:** only display the battery indicator, and the illustrations are different according to the battery level as shown in the table below. When the battery capacity is running out, it will pop up a warning as shown in Figure 5.1-28, please replace the battery in time, and click OK to close this prompt.

- **AUTO:** display the input channel, signal format and battery indicator (available only when the battery level higher than 10.5V), and turn off this menu after 10s automatically, while the signal format changes, it will show once more, and then vanished after 10s.



**Figure 5.1-28 Battery Warning**

Range of battery level	Illustration
100%	
>80%	
<80%, >60%	
<60%, >40%	
<40%, >20%	
<10%	
Nearly running out	

### Tips

- For the differentiation of battery providers, the illustrations and values for various battery levels in the above table are for reference only, please don't take it for granted and judge it as the real battery level !

### 5. Language

Set **USER CONFIG**→**Language** item as Chinese or English, and the default menu language is English.

### 6. Monitor Reset

Select **USER CONFIG**→**Monitor Reset** item, it will pop up a prompt, as shown in Figure 5.1-29:

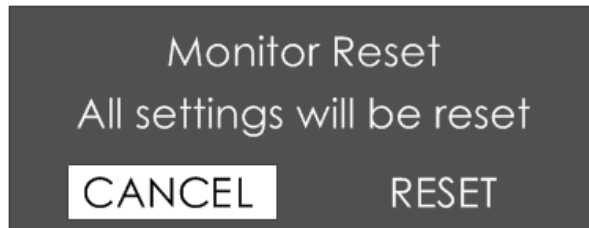
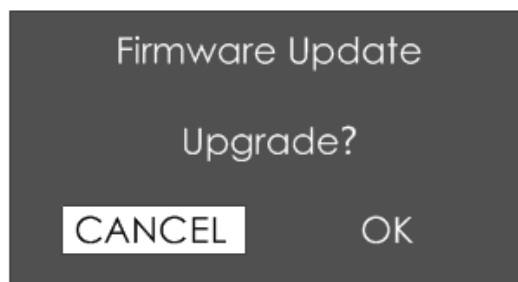

**Figure 5.1-29 Prompt for Monitor Reset**

Press right arrow(➤) button to select **RESET** command, and click **OK/MENU** button to confirm the selection, the menu settings will restore to factory defaults.

### 7. Firmware Upgrade

Select **USER CONFIG**→**Firmware Upgrade** item, it will pop up a prompt, as shown in Figure 5.1-30:



**Figure 5.1-30 Prompt for Firmware Upgrade**

Press right arrow(➤) button to select **OK** command, and click **OK/MENU** button to confirm the selection, it will read the new firmware files from your USB drive and update your firmware. Make sure you have inserted your USB disk with the stored firmware files into the USB interface of the monitor, or it will inform you a “**Can’t Detect USB**” error.



**Figure 5.1-31 Warning for Firmware Upgrading**

## Tips

- Please keep the monitor are well powered on, and don't remove the USB drive during the firmware upgrading.
- It is recommended to use a 3.0 USB!
- Restart the monitor after successful firmware update, and the new files will take effect.

### 5.1.5 IMD CONFIG Menu

The IMD CONFIG menu items are used to adjust the parameters defined for IMD display, the menu items are as shown in Figure 5.1-32:

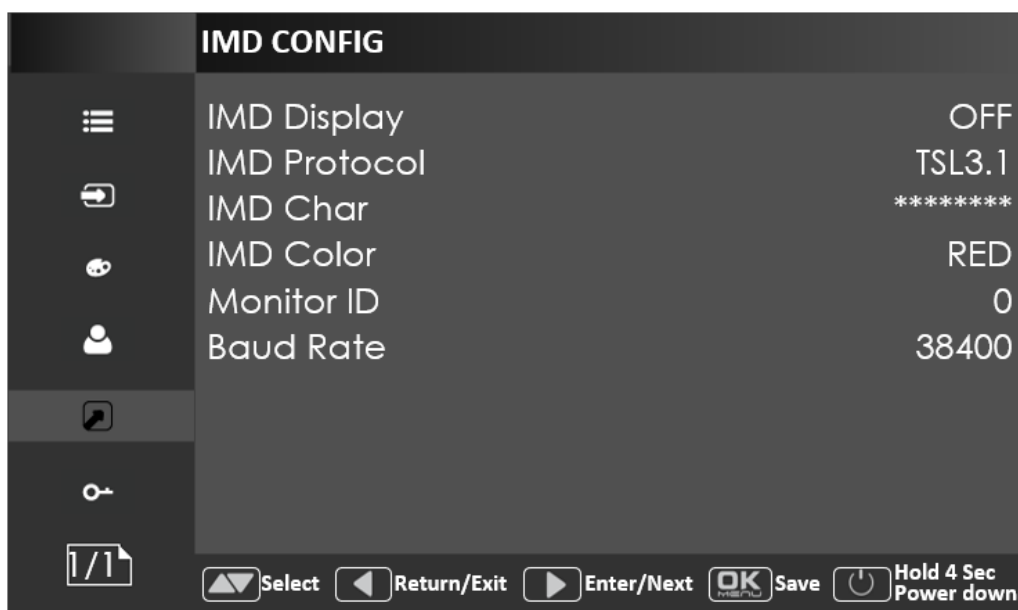

**Figure 5.1-32 IMD Menu**

The relationship of Items, Default Value, Domain Range and Description of the sub-item is shown in Table 5.1-10:

**Table 5.1-10 The Description of IMD Menu Items**

Items	Default Value	Domain Range	Description
IMD Display	ON	OFF/ON	Set whether to display IMD Characters on screen.
IMD Protocol	Local	TSL3.1/TSL4.0/ Local	Select an IMD protocol
IMD Char	---	---	Set the IMD characters, only available in Local IMD protocol
IMD Color	Red	Red/Green/Yellow	Set the IMD character color
Monitor ID	0	0~255	Set the ID number for each monitor
Baud Rate	38400	2400/4800/9600/19200 /38400/57600/115200	Select a baud rate for communication.

### Tips

- If **IMD Display** item is ON, the IMD character in the black bar will display on the bottom of the screen.
- When the **IMD Protocol** is set to be Local, it displays IMD characters set in **IMD Char** item, and the **IMD Char** could be composed of up to 16 characters or up to 12 Chinese characters. For other values of **IMD Protocol**, the IMD character abides by the corresponding protocol.

### 5.1.6 KEY INHIBIT Menu

The KEY INHIBIT menu item is used to lock the setting so that they can't be changed by an unauthorized user, and the menu item is as shown in Figure 5.1-33:



**Figure 5.1-33 KEY INHIBIT Menu**

The relationship of Items, Default Value, Domain Range and Description of the sub-item is shown in Table 5.1-11:

**Table 5.1-11 The Description of KEY INHIBIT Menu Items**





Items	Default Value	Domain Range	Description
Key Inhibit	OFF	OFF/ON	Enable/Disable the key.

### Tips

- When KEY INHIBIT is ON, pressing POWER button can turn on or off the monitor, pressing OK button can pull out KEY INHIBIT menu and disable KEY INHIBIT, other buttons' functions are all disabled.

## 5.2 Menu Settings

When checking or modifying the value of the menu item, cooperating with the

following buttons:  (LEFT),  (DOWN),  (UP),   
 (RIGHT),  OK/MENU.

## 1. Operations to the MAIN menu

### ■ Display the first level menu

Press **OK/MENU** button to enter into the MAIN menu, it displays at the center of the screen.

### ■ Switch menu items

After displaying the first level menu, press **LEFT, DOWN, UP, RIGHT** button to choose a menu item.

### ■ Back to the first level menu

After entering to second level menu item or second level menu item value, press **LEFT** button to back to the first level menu area.

### ■ Close the MAIN menu

Press **LEFT** button to close the MAIN menu when the control icon is in the first level menu item.

## Tips

---

- Set the show time of the MAIN menu by **USER CONFIG→Osd Time** item.
- 

## 2. Operations to second level menu item

### ■ Display the second level menu item

After display the first level menu, press **RIGHT** button to choose the second level menu items.

### ■ Switch second level menu items

Press **DOWN** or **UP** button to choose or switch to the second level menu item.

### ■ Back to menu item

Press **LEFT** button to back to the first level menu item.

### ■ Turn Page

Choose the **Next Page** selector, then press **Right** button or **OK/MENU** button to turn to the next page.

## 3. Operations to second level menu item value

### ■ Switch second level menu item value

When the control icon is in second level menu item value, press **DOWN** or **UP** button to switch among its value list.

- **Confirm the modification to second level menu item value**

Press **OK/MENU** button to confirm the selection of a value, and the control icon is back to the corresponding menu item.

- **Abandon the modification to second level menu item value**

Press **LEFT** button to give up the modification to second level menu item value, and the control icon is back to the corresponding menu item.

#### 4. Operations to Fast menu

- **Display fast menu**

Press **UP** or **DOWN** button to enter into the fast menu when not in the **MAIN** menu.

- **Adjust fast menu item value**

Press **LEFT** or **RIGHT** button to adjust the fast menu item value.

### **Tips**

---

- The value in white color is modifiable, and the value in gray color is unmodifiable.
-



## Chapter 6 Specifications

### 1. Product detailed information

Specification	Values
Model	MEGAMON 15
Dimension	15.4"
Dimension(WxHxD)	368.9x264.9x 54.5mm
Pixel Pitch (WxH)	0.1722×0.1722mm
Aspect Ratio	16:10
Display Area (WxH)	330.62×206.64mm
Viewing Angle (HxV)	178° x178°
Color Depth	1.073G Colors
Resolution	1920×1200
Contrast (Typ.)	1450:1(Typ.)
Luminance (cd/m <sup>2</sup> )	800
Response Time (ms)	18
Backlight	WhiteLED
Backlight Life(Hrs)	20000(Min.)
Work Temperature	0° C~50° C
Power Supply	100~240V50/60HzAC /11~17V3A DC battery
Power Consumption	29.3W
Video Input Interface	3G/HD/SD-SDI(X2)
	VIDEO(X1)
	HDMI(X1)
Video Output Interface	3G/HD/SD-SDI(X1)
Audio Input Interface	3.5mm Jack
Audio Output Interface	3.5mm Jack (Headphone)
Control Interface	2.5mm Jack (REMOTE)
	USB
Signal Formats	SD-SDI: 480i60, 576i50
	HD-SDI: 1080i50, 1080i 59.94, 1080i 60, 720p50, 720p

Specification	Values
	59.94, 720p 60, 1035i59.94, 1035i 60
	3G-SDI: 1080p50, 1080p60
3G-SDI /HD-SDI /SDI-SDI Input/Output	
Signal Type	SMPTE 424M, SMPTE 292M, SMPTE 259M, SMPTE 297M
Connector	BNC per IEC 169-8
Impedance	75Ω
Return Loss	>18 dB 5 to 270 MHz >15 dB 270 MHz to 1.5 GHz >10 dB up to 3 GHz
Maximum Signal Level	800 mV pk-pk 10%
Signal Amplitude	800 mV pk-pk 10%
DC Offset	0 V ±0.5 V
Overshoot	<10%
Jitter	<0.2 UI
Rise/Fall Time	<700 ps for SD <270 ps for 1.5 Gb/s HD <135 ps for 3 Gb/s HD
Extinction Ratio	>8
Back Reflection	<-14 dB

## 2. Dimensions

The description of the product dimensions is shown as in the following figures:

- MEGAMON 15

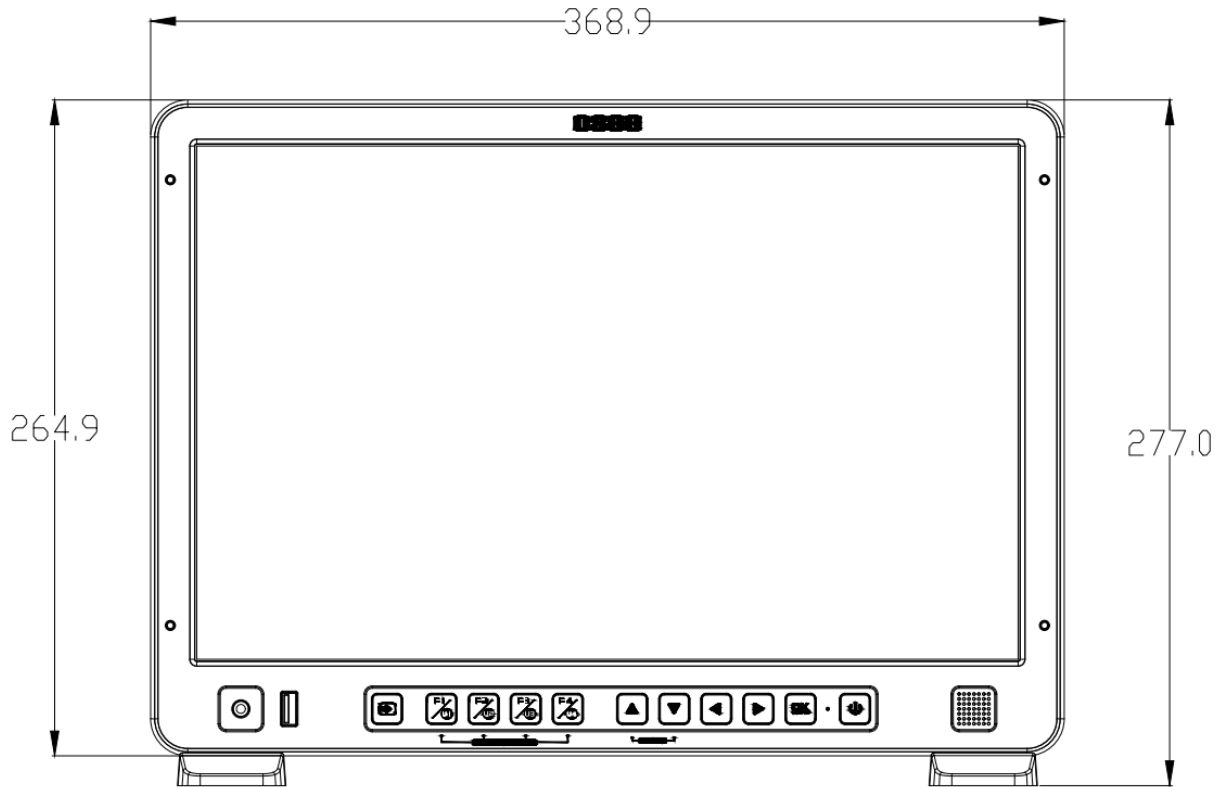

**Figure 6-1 Front Panel(Unit: mm)**

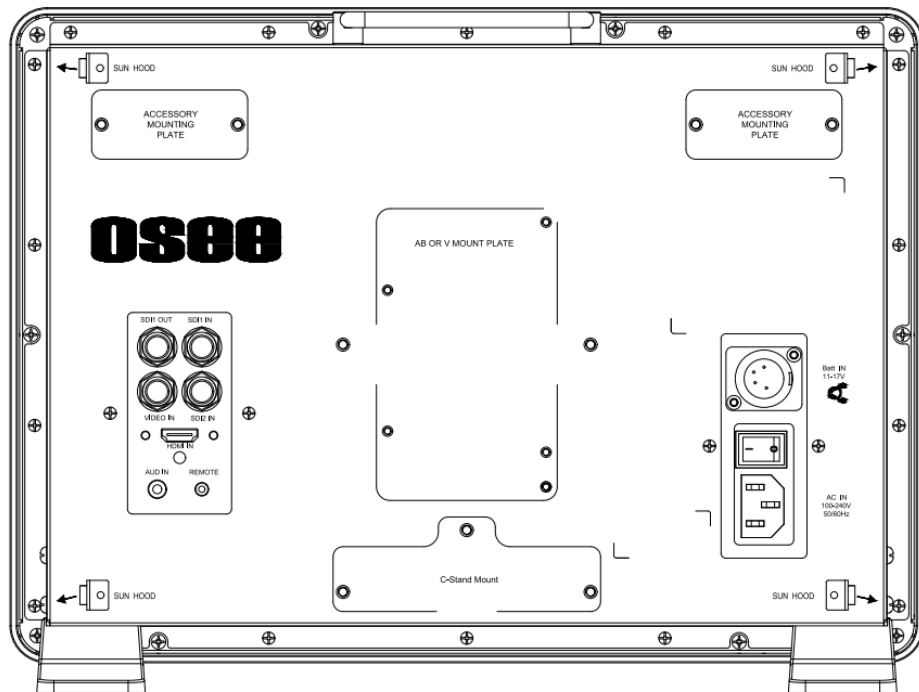

**Figure 6-2 Rear Panel(Unit: mm)**

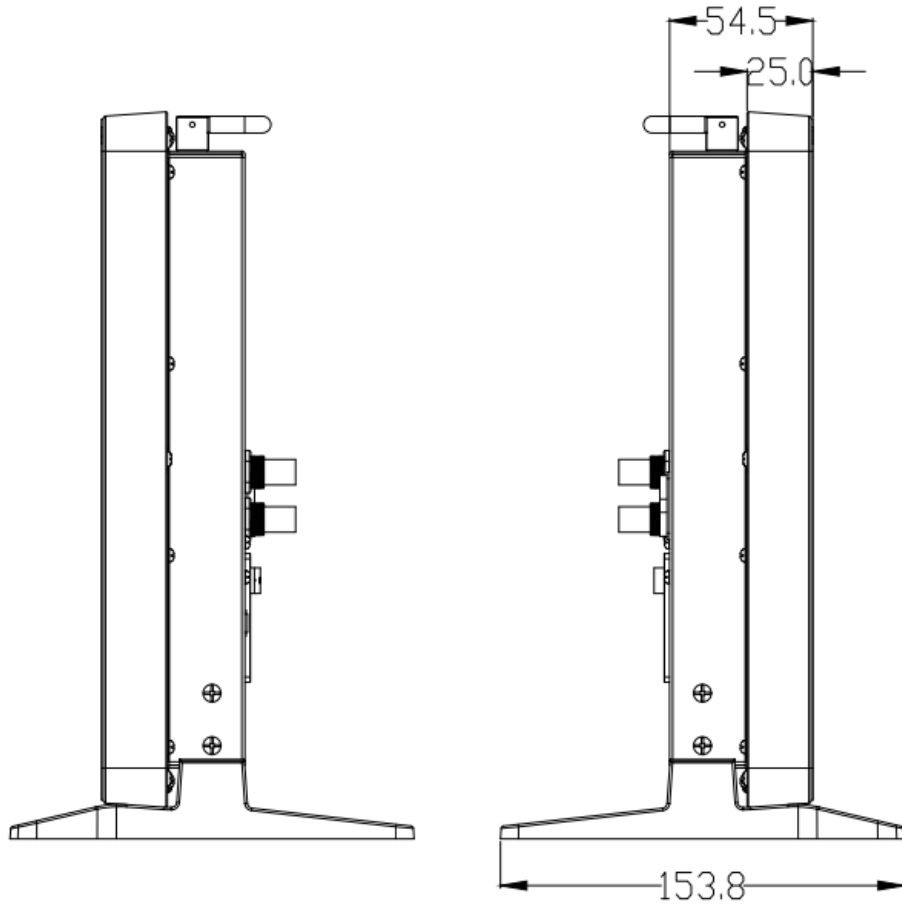

**Figure 6-3 Side View(Unit: mm)**

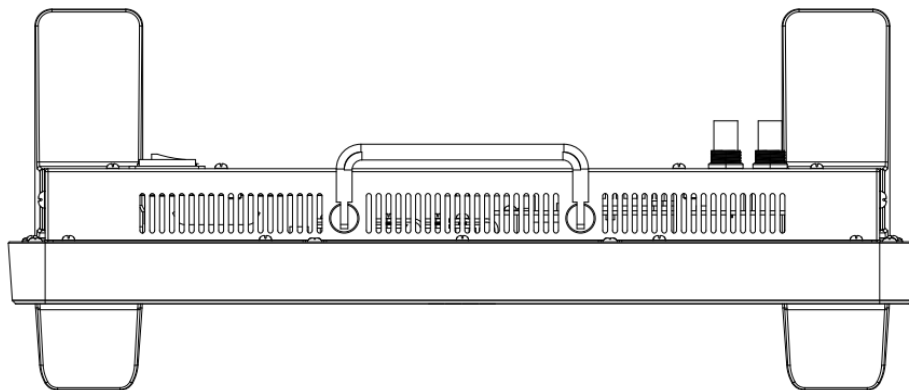

**Figure 6-4 Top View(Unit: mm)**

**i Tips**

---

- Specifications are subject to change without notice.
- 

-----No Text Below-----





---

FOR MORE INFORMATION PLEASE VISIT: <http://www.osee-dig.com/>  
OSEE TECHNOLOGY LTD.

No.22 Building, No.68 zone, Beiqing Road, Haidian District, Beijing, China

Tel: (+86) 010-62434168, Fax: (+86) 010-62434169

E-mail: [sales@osee-dig.com](mailto:sales@osee-dig.com)