

ELECTRIC FENCE ENERGIZER

CONTENTS

PLANNING INFORMATION.....	2-13
OVERVIEW.....	14
INSTALLATION.....	15-16
VOLTAGE OUTPUT INDICATOR.....	17
GROUNDING SYSTEM CHECK.....	17
SAFETY.....	18
MAINTENANCE.....	18
REQUIREMENTS FOR ELECTRIC ANIMAL FENCES.....	18-19
DECLARATION OF CONFORMITY.....	19

PLANNING INFORMATION

Fence System Type

Permanent Electric Fencing, Semi-Permanent Electric Fencing or Temporary Electric Fencing.

Permanent Electric Fencing

Good installation is the key for successful permanent fences. either Softwood, solid corner posts, must be very firmly installed at all corners, changes of fence line direction, and gateways. In-line posts can be a combination of posts and droppers, which is the most cost effective method of erecting long, permanent fences. Softwood posts and insulators can provide a good alternative.

Except where high visibility is required, for example horse fencing where tape and rope can be used, permanent fences are best constructed using 2.5 mm iron wire which is both extremely conductive and durable.

Always use good quality insulators on permanent fencing. This is particularly important on long fences with high powered energizers, as poor quality insulators may not withstand the high voltages and joules needed to effectively power a fence of many meters.

Always use mains energizers when possible and, if vegetation growth is likely, buy a higher powered model as it will help compensate for fence shorts, or cut the vegetation growth.

Semi-Permanent Electric Fencing

Half-permanent fences are designed to stay in the same place for up to a year or two. They are best used for horses, outdoor pigs, poultry, or to protect a new crop planting from vermin.

For best stability corner posts, gateways or sharp bends in the fence would consist of wooden posts. These should be very firmly installed and suitable insulators used with softwood posts. In-line posts could be either plastic or steel and the conductors could be tape, rope, nets or stranded steel wire.

Energizers should be mains powered when there is a convenient power supply. Alternatively, 12-volt wet battery energizers are a good choice. They are portable, although heavier than internal battery energizers, and they can operate longer fences more effectively than 6-volt and 9-volt energizers.

Temporary Electric Fencing

Temporary fences are moved regularly and can be constructed using battery or solar powered energizers, steel or plastic posts for single or multi wire fences and poly wire, poly tape, poly rope or nets and other lightweight components.

Typically these would be short fences of up to a few hundred metres in length to contain or exclude animals from a moving area such as strip grazing. Energizers with 6-volt or 9-volt internal batteries are lightweight and easiest for moving regularly but are generally most suitable for short fences of up to about 2.5 kms maximum length (depending on which wire conductors are used).

What type of Animal

Electric Fencing for Cattle

There are several options for fencing cattle. Depending on the breed of cattle, the number of fence wires can vary from one to six.

Dairy Cattle: Dairy cows are among the easiest animals to contain with electric fences because they are relatively docile and are used to daily human contact. The energizer is 0.25Joules and 2,000~3000volts for Dairy cattle.

Beef Cattle: To safely contain most beef cattle, you need an energizer that delivers a minimum of 2,000~3,000 volts on the fence line. Voltage levels are impacted by vegetation on the fence line, length of fence and type of wire.

Bulls: If normally kept segregated for breeding purposes, bulls or other aggressive livestock may become highly motivated to escape confinement, especially when nearby cows are in heat. To contain bulls, maintain 3,000~4,000 volts on the fence line with an energizer that has a minimum of 1.5 Joules of stored energy. Four to five wires are best. For more aggressive animals, you want the electrified fence to deliver a more intense shock to discourage them from going near the fence again so higher joules would be desirable on long fences.

Note: A minimum of 4,000~5,000 volts on the fence line is required to keep out predators.

Size of Cattle

Most cattle are fattened on grass aged between a few months and up to 2 years and are usually reasonably docile so 3 wires would probably suit. The wire spacing depends on the breed / size of the cattle but as a guide, on a permanent / boundary fence, the wires should be spaced at knee height, lower chest and upper chest heights.

PLANNING INFORMATION

Wire Spacing Guide

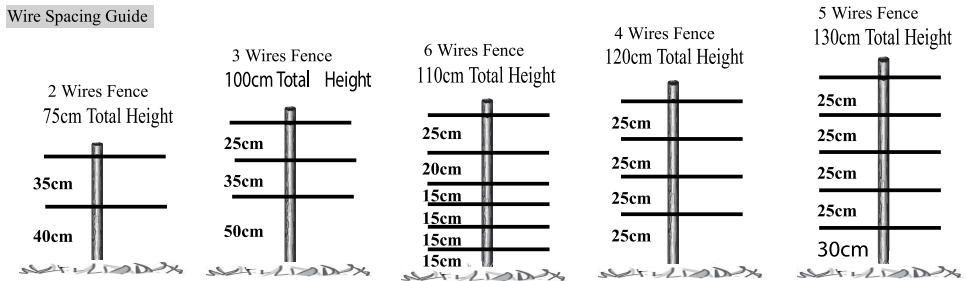

Tip: A fence enclosing both cows and calves requires an electrified wire at the nose-level height of each.

Type of Fence

Temporary

If it is a temporary subdivision within a permanent boundary, total security may not be an important issue, therefore, poly wire or tape on plastic moveable posts may be best.

Strip Grazing

Strip fencing for dairy cows is normally carried out using a portable energizer, (consider 9v power for ease of daily moving) poly wire or tape and plastic posts or metal pigtail posts. Strip grazing fences are usually adequate with a single conductive wire about 90~100cms (3 ft) or so above the ground. The use of reels for rewinding the poly wire makes moving the fence much more efficient.

Permanent

Assuming no secondary barrier such as a hedge or wall, a permanent boundary fence should be constructed of timber posts, high tensile wire and ideally a mains powered energizer.

Trained Cattle

Are the cattle used to electric fencing within a limited grazing area? If not, care should be taken to ensure they are trained to respect the fence by allowing them to touch the conductor and receive a severe shock. All farm and domesticated animals need initial "training" to respect the fence, preferably under supervision, to ensure they learn where the shock comes from so they stay away. A high level of shock must be received initially to create the psychological "fear" imprint to ensure they quickly learn to respect the fence.

Electric Fencing for Horses

Electric fence is ideal for horses because it: is safer than traditional fencing; works effectively; can prevent cribbing and wear on the fence; is less expensive than traditional fencing; is simple to install and maintain; is easy to electrify an existing fence

Horses are easy to control with electric fencing. They are intelligent animals and quickly learn to respect an electric fence. In addition, horses have thin hides and are usually shod. If shod, the metal horse shoes make an excellent earth connection. A shod, well-groomed horse will feel a more intense shock than a long haired horse without steel shoes.

Horses tend to use traditional fences as scratching posts, causing the fence to weaken or sag over time. They may also fall into the habit of "cribbing" or chewing fences. An electric fence prevents both of these behaviors, thus protecting the horse from harm and prolonging the life of the fence.

If a horse is spooked and runs through traditional wire or wooden fencing, injury is more likely to occur than with an electric fence made of poly tape, wire or rope.

To safely contain horses, you need an energiser that maintains a minimum of 3,000 volts up to the end of the fence line. On very short fences, up to 200 yards long, an energiser of 0.05 Joules would be adequate for subdivision. Voltage levels and therefore the shock are affected by vegetation on the fence line, length of fence and type of poly tape or rope.

PLANNING INFORMATION

Wire Spacing Guide

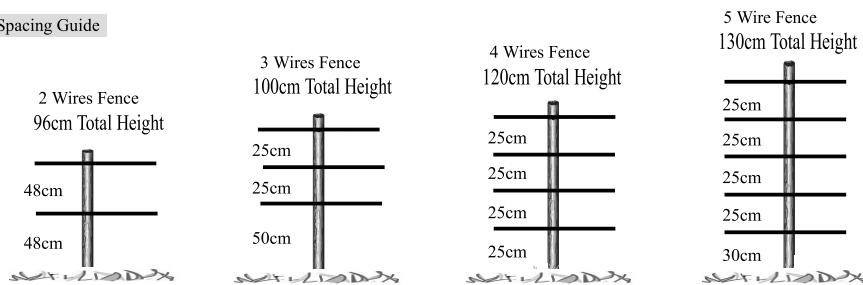

Fence posts should be of sufficient height to ensure good visibility of the conductor. For example, a 17 hands horse would be best contained by a post which permits a top wire of around 122cm above ground. A 14 hands pony could be contained with a post of 96cm. The posts for temporary fencing can be spaced up to 10 metres apart but ensure the wire is well anchored at the ends of the fence.

Two strands of tape or rope provide optimum visibility and safety with the bottom one at about lower chest height and the top one at upper chest level. To contain foals, be sure to have a strand of electrified poly tape/rope close to nose level.

Electrifying an Existing Fence

You can easily add electrified wire to an existing fence. This option can prevent "cribbing" or chewing the tops of wood fences, keep horses from jumping, or prevent animal pressure on the fence. Select from a variety of insulators for post-top or offset fence wire mounting to existing fence.

Note: We acknowledge that, for aesthetic reasons, many people prefer green tape, rope and posts. However, for high visibility against the green background of grass or hedges, we recommend the use of white fence material.

Note: Conventional high tensile fence systems and barbed wire are not recommended for equine fencing, as they are more likely to injure horses should they run into them.

FAQS

Is electric fencing safe for my horses?

The short sharp shock your horse receives from an electric fence will not injure it, but will teach it to respect and avoid the fence. Very roughly, the shock produced by a small energiser is similar to a sharp whack by a riding crop.

Traditional fencing is more apt to injure horses when they get scared or spooked and attempt to push through or jump over it. A properly installed electric fence system is the safest, most visible method to keep your horses contained.

Why electric fence better than other types of horse fences?

Electric fencing is the most cost effective and efficient method of containing horses while safeguarding them from injury. Barbed wire, woven wire, and wooden fences can injure a "spooked" horse that attempts to run through or jump over them. Injuries a horse will sustain if it gets tangled in barbed wire may be fatal.

Electric fencing is lower cost, easier to install, requires less maintenance and controls horses more effectively than traditional fencing.

What's the best way to fence aggressive horses or stallions?

If normally kept segregated for breeding purposes stallions, or other aggressive horses, may become highly motivated to escape confinement, especially when nearby mares are in heat.

To contain aggressive horses, maintain 3,000 - 4,000 volts to the end of the fence line. Three or four strands of fence wire are best. The more aggressive the horse, the higher the shock must be to discourage them so generally higher joule energisers are recommended.

How do I prevent "cribbing"?

An electrified wire can easily be added to an existing fence. This option can prevent "cribbing" or chewing the tops of wood fences, as well as keep horses from jumping, or prevent animal pressure on the fence. A range of insulators is available to allow an electrified wire to be erected on the top or interior of the fence. Offset type insulators will put the fence wire 13 - 22 mm out from the existing fence, preventing animals from pressing against it.

PLANNING INFORMATION

Electric Fencing for Sheep and Goats

SHEEP

Sheep can be relatively difficult to contain with an electric fence because, although they tend to be docile, in winter they do have thick fleece, presenting unique challenges because wool does not conduct electricity and so requires more power than shorthaired animals. Exclusion of predators such as foxes can frequently be a problem in Spring when lambs are born.

Sheep require 3,000 - 4,000 volts on the fence line together with an energiser with not less than 1.5 joules of stored energy and higher on long fences. Voltage levels are affected by vegetation on the fence line, length of fence and type of wire. Ideally a minimum of 4,000 - 5,000 volts on the fence line is required to keep out predators such as foxes from young lambs.

Note: because lambs are erratic and a target for predators, consider the use of electric netting, particularly for lambing pens, as it makes containing lambs and exclusion of foxes much easier.

Goats

To safely contain goats, you need an energiser that maintains 4,000 - 5,000 volts on the fence line and around 1.5Joules of stored energy depending on the fence length.

Goats require closely spaced fence wires that start low to the ground and are high enough to prevent jumping over the fence. We recommend using five to six wires spaced to an overall height of 100 - 115cms.

Wire Spacing Guide for Sheep and Goats

Depending on a variety of factors, particularly the breed of sheep and whether or not they are used to electric fencing, the number of fence wires can vary from three to six, depending on:

- Is the fence temporary for holding on fodder beet or similar?
- Will you keep lambs and ewes together?
- Are predators a problem?

Wire Spacing Guide

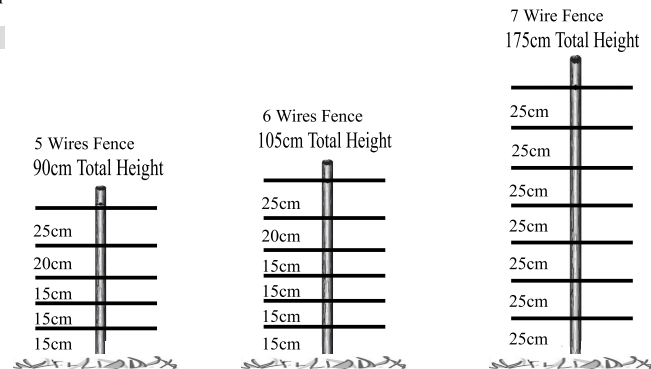

For more permanent fences use wooden posts and high tensile wire. A minimum of three strands is needed for adult sheep but where lambs are to be fenced, more and closer spacing will be necessary.

Electric Fencing for Pigs

Commercially farmed pigs are easy to control with electric fencing as they have very little hair and large, wet noses. Intelligent animals, pigs quickly learn to respect and avoid electric fences.

To safely contain pigs you need an energiser that maintains a minimum of 3,000 volts on the fence line and, depending on the length and complexity of the paddocks, a minimum of 1.5 stored joules. Remember that voltage levels and the shock received by the animal are affected by vegetation on the fence line, length of fence and type of wire.

PLANNING INFORMATION

Tips for Pig Fencing

With fence wires close to the ground always ensure vegetation on the fence wire is kept to a minimum. Piglets kept with your pigs will require wires to be spaced closer together and lower to the ground than adult pigs alone.

Most commercial pig herds are kept in paddocks which have divisions consisting of two wires only. These are placed about 25cms above ground and 45cms above ground.

For a secure boundary fence which will also exclude foxes, consider a 9 wire fence approximately 120cms high, using stranded steel wire. With the fence wired alternatively live/earth a fox scrambling over or jumping between wires will receive a shock even though his feet are off the ground.

Electric Fencing for Poultry

Electric fencing for poultry is a effective method of containing both domestic and commercially kept chickens, turkeys, ducks, geese, and can also be a big deterrent to predators such as foxes.

For relatively small areas of domestic poultry (such as a back yard and where the poultry are kept indoors overnight so risk of predator attack is small), The poultry nets are the easiest to erect and move. With a suitable energizer, they will contain non flying poultry effectively. The nets are available in orange colour or, as a less obtrusive alternative, green.

Only horizontal wires of nets are electrified and the bottom wire, which usually rests on the ground, is not electrified to avoid shorting the fence to the earth.

For large commercial flocks, nets are ideal as an inner fence or sub-division to contain poultry. Where predators are likely to be a problem, a more secure boundary is desirable.

Electric Fencing for Pets

Elite provides several different options for electric fencing to contain dogs and other domestic pets. This includes adapting existing fences, semi-permanent fences and temporary fencing. The best choice will depend on your dog's personality, height, weight, fur length, and the tendency of the breed to dig or jump.

Electrifying Existing Fences

Are you tired of your dog escaping from your fenced yard or garden? For existing wood, vinyl or chain link fences, an electrified wire at the bottom will prevent digging, and/or an electrified wire at the top will prevent climbing and jumping.

Elite insulators are available in a variety of styles to match your current fence. Add some poly wire or poly tape along with an energiser and earth system to provide a simple, low cost way to "dog-proof" an existing fence. (Note: you cannot directly electrify a chain link or woven wire fence, as it will simply earth the fence and destroy the shock effect).

Semi-Permanent Pet Fence

You can create your own fence using wooden or plastic posts and poly wire or tape. Fence posts should be spaced 2 – 5 metres apart, depending on the shape and terrain of your garden. Wires should start close to the ground and then be spaced 100-150 mm apart. Use three to 10 wires, depending on the size, personality and jumping ability of the dog.

Because the wires are close to the ground, they should be kept free of vegetation.

Temporary Pet Fence

An affordable, short term pet containment includes an energiser, poly wire, plastic posts, and connectors that allow you to get your fence up

Wire Spacing Guide

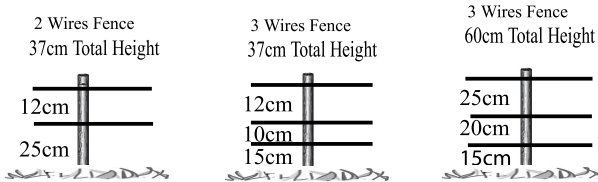

PLANNING INFORMATION

and operating quickly. A temporary or portable system, the Garden Kit makes travelling with your pet easy and convenient.

FAQS

Is electric fence safe for my pets?

The short, sharp shock your pet receives from an electric fence will get their attention, but not harm the animal. This will teach it to avoid the fence in the future and stay within the boundary.

Why would I use an electric fence instead of a traditional fence?

Electric fences are portable and far less costly than a barrier type fence. Additionally they can be unobtrusive - you do not block the view. Using electric wires on the top or bottom of a chain link or wood fence can prevent digging under or jumping over the fence.

Can I electrify an existing wood, vinyl or chain link fence?

You can easily add to an existing chain link or wood fence. The insulators are available in a variety of styles that give the flexibility of putting a double (wired live / earth) electrified fence at the outside top of the fence (to keep dogs, cats, and other animals from climbing or jumping over) or at the outside bottom to prevent dogs from digging underneath. This is a simple, low cost way to "dog-proof" an existing fence. (Note: you cannot directly electrify a chain link or woven wire fence, as they are not insulated).

Electric Fencing for Predators, Nuisance Animals and Deer

Solutions for Keeping Out Predators and Nuisance Animals

Electric fencing is an excellent method of containing or excluding most species of animals, including foxes, badgers, deer and wildlife. Additionally, fish ponds can be effectively protected from herons and otters to preserve valuable fish stocks.

Nuisance animals such as rabbits, deer, & badgers cause millions of pounds worth of damage and frustration to farmers, gardeners and home owners. They can devastate cereal crops, vegetables, gardens, shrubs and trees. To exclude small pests, you will need closely spaced fence wires, from 7 – 10 cm or electric netting.

Note: we do not recommend netting for fencing against badgers, but is very effective against rabbits and foxes.

Company offers garden fence kits for quick and easy installation which can be effective against domestic pets but would not exclude large animals such as badgers where a more substantial fence is needed.

Like other animals, predators and wild species will quickly learn to avoid the shock of an electric fence. To exclude large nocturnal predators such as badgers, a physically strong fence is also necessary as they tend to have established runs and would not see electric fence wires in the dark.

Unlike conventional domestic animals, wild species pose additional fencing challenges. For example, they may have long, shaggy coats or thick plumage that does not conduct electricity well. Predators are highly motivated to get the animals on the other side of the fence as a source of food. Poultry and other domestic livestock are particularly attractive to foxes. Domestic animals become conditioned to the electric fence, usually avoiding it after a few shocks. However, predators may endure repeated shocks in their determination to get to their "food source" particularly when they have young to feed and nourish.

Predator fences need to shock severely, plus serve as a physical barrier. The fence needs to be sturdier, have wires more closely spaced, and may need to be taller than the animals being contained. For these reasons, we recommend permanent high tensile, or stranded steel wire fence systems for keeping out predators

Wire Spacing Guide for Predators and Nuisance Animals

Wire spacing should be close enough to prevent the animal from stepping through or putting its head between the wires. One of the electrified wires should be at the animals' nose level.

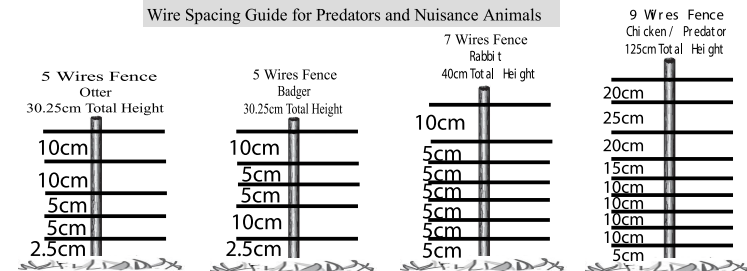

PLANNING INFORMATION

Note: An electrified top wire above the animal's head is recommended if the animal is a habitual jumper. If you are unfamiliar with fencing for a particular species, please contact our agent for advice.

Electric Fence Solutions for Keeping Out Deer

Deer need fencing that provides both a physical and psychological barrier like electric high tensile fence. An electrified high tensile fence is the best choice because it can be tall, durable and secure, and also serves to keep predators out.

Electrified high tensile fencing is an excellent choice for a permanent perimeter fence. These low-maintenance fences can last up to 20 years and are the best solution for deer control. The high tensile wire and spring system of a high tensile fence allow it to flex and return to its original shape if run into, making it optimal for deer.

The first step in successfully keeping deer out is to put up a sturdy and highly visible fence. In most instances this means a 2 metre tall fence using permanent high-tensile electrified fence. Consider using Electro-Wood, the self-insulating timber from sustainable hardwood forests on permanent high tensile fences. It consists of posts and droppers so is simple and low cost to install, highly durable and environmentally friendly. On large scale fences such as for heather preservation in the Highlands, the most cost effective system can be to use a double fence.

Deer have a heightened sense of smell and using bait on the fence will attract and slow them down. The bait will prompt deer to touch the fence with their nose or tongue, receiving a safe but intense shock. A shock in front of the eyes causes the deer to learn where the pain comes from and leave the area. After one or two encounters with an electric fence, deer will usually look for other sources of food.

Deer require an energiser that can maintain 3,000 - 4,000 volts on the fence line and a minimum of 1.5 joules of energy, higher on long fences. Voltage levels are affected by vegetation on the fence line, length of fence, and diameter of wire.

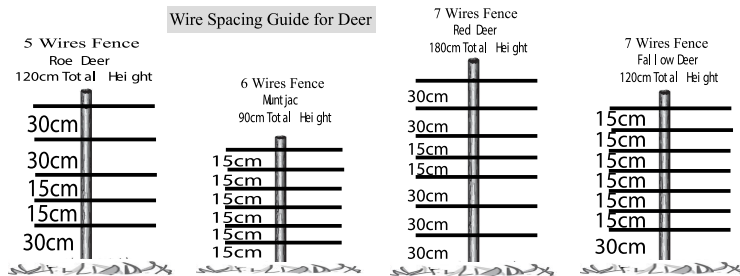

Wire spacing should be close enough to prevent the animal from stepping through or putting its head between the wires. Attach seven to nine wire strands to posts that stand at least 2 metres above ground. Be sure that wires are placed near the nose level of the animal. Use a low impedance fence controller.

Note: To prevent jumping, an electrified top wire above the deer head is recommended.

FAQS

Will the electric fencing I use for livestock and containing other animals also keep out predators?

Not usually. If you are already installing a high tensile fence, you can simply change the height of the bottom wires and alter the number and spacing of wires to keep out predators. Also, ideally electric wires will need to be placed alternately on the outside of the fence as well as inside predators and livestock will remain on their respective sides of the fence. Where the predators, such as foxes, are known to jump, fence should be wired alternately live / earth so they get a shock even when all feet are off the ground. Most temporary fencing is less effective against predators, as there are an insufficient number of electric wires and the fence presents less of a physical barrier.

Will electric fence harm animals or people?

The electric shock delivered by an electric fence energiser, while intense, is very brief and will not harm people or animals. All Electric Shepherd energisers comply with the latest European Standards and are certified by TUV company test house. The pulse energy operates at one second intervals, giving people or animals ample time to release the wire. The electric pulse deters pests, but is not strong enough to harm people, children or pets, although, of course, it will be painful if touched.

PLANNING INFORMATION

Why do you recommend at least 2 metre tall electric high tensile fence for farmed deer?

Deer are not easily domesticated - they are accustomed to roaming where they please, which is usually to find food sources. Since they are strong jumpers, they can easily clear a fence that is their height. In addition, they may "test" electric fence by running into it to get out, so fence needs to be durable and resilient to pressure. Electric high tensile fence is ideal solution since it is long lasting, extremely strong, and will maintain its shape even if run into. It can easily be built to 2 metre or taller heights.

Will nuisance pests learn to avoid my electric fence?

All animals dislike the feeling of an electric shock. After one or two encounters with an electrified fence, most animals will quickly learn to avoid the area enclosed by the fence, however, NEVER turn the electric fence off when animals are in the vicinity as when they touch the fence without receiving a shock, it can cause the psychological imprint to be diluted.

For deer we recommend train them to avoid your fence by baiting the fence. Small animals generally do not require baiting. Once the animals receive a shock, they will avoid the area and find food elsewhere.

Can I electrify an existing woven-wire or chain link fence?

The chain link insulator allows you to add hot wires to an existing, uncoated chain link or woven wire fence. This gives you the flexibility of putting an electrified wire at the outside top of the fence (to keep animals from climbing over) or at the outside bottom (to keep animals from digging under). This is a simple, low cost way to "animal - proof" an existing fence.

Note: you cannot directly electrify a chain link or woven wire fence, as the fence is not insulated and will cause a short, thereby making it ineffective.

What factors are important to successfully keep out animals with an electric fence?

Because you're excluding animals rather than containing them, the wires need to be placed in outside of posts. In addition, wires need to be spaced closely enough to prevent small animals from getting through.

For best results a properly installed fence system is important. View installation tips for details.

Electric Fencing for Exotic Animals

Electric fencing is an excellent method to contain nearly all types of animals, including exotics such as llamas, emus, ostrich, and deer and elk. Like other animals, exotic animals will quickly learn to avoid shock of an electric fence. However, unlike conventional domestic animals, exotic species pose additional fencing challenges. For example, they may have long shaggy coats or thick plumage, do not conduct electricity well. In addition, many species exhibit excitable behaviors. Unfamiliar and unexpected sounds or stimuli, like honking traffic or barking dogs, may create stress and erratic behavior.

We recommend electrified high tensile fence as a safe and secure solution for most species. A high tensile fence will not only contain your exotic animals, it also will keep predators out. Choose a low impedance energiser that maintains high energy levels on the fence. Wire spacing should be close enough to prevent the animal from stepping through or putting its head between the wires. One electrified wire should be at the animals' nose level. An electrified top wire above the animal's head is recommended if it is a habitual jumper.

If you are unfamiliar with fencing for a particular species, please contact our agent for advice.

Electric Fence For Llamas

Llamas are very intelligent and quickly learn to respect an electric fence. As highly sociable herd animals, they are more comfortable around other llamas, making them easy to control and train. However, they present some unique challenges because their thick coats do not conduct electricity well and predators can be a problem, especially for young crias (baby llamas).

We recommend electrified high tensile fence as a safe and secure solution. A high tensile fence works well to contain llamas and also serves to keep predators out. Llamas require an energiser that can maintain 4,000 - 5,000 volts on the fence line. Voltage levels are impacted by vegetation on the fence line, length of fence and type of wire. A minimum of 5,000 volts on the fence line is required to keep out predators.

Depending on a variety of factors, the number of fence wires can vary from four to six, depending on: whether you will separate cria at weaning, if you keep breeding males separated, and if predators are a problem.

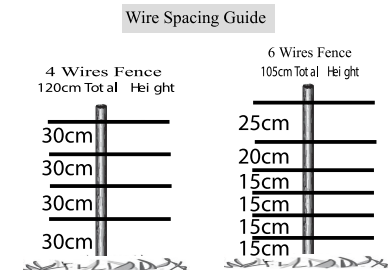

PLANNING INFORMATION

Although llamas have a natural dislike for canines and can protect themselves by kicking, they may be bothered by predators. However, crias are more susceptible to predators. A high tensile fence with properly spaced wires will deter predators.

Electric Fence for Ostriches

Ostriches, emus and rheas can be challenging to contain. However, electric fence provides an affordable, easy to install, low maintenance option that will safely contain Ostriches whilst excluding predators.

Ostriches have a tendency to reach over, under or through any type of fence to eat grass on the other side. Plus, they can grow to more than 2 metres tall. While these birds don't fly, they do jump. This means the wire spacing needs to be close together and at least 2 metres high.

If using electric fence with ostriches, consider that feathers are not good conductors of electricity. Therefore a high powered energiser must be used. Two-legged species have less contact with the ground than four-legged animals, thus making a properly installed earth system essential.

Existing or Shorter Fences

A closely spaced woven wire fence, 5 cm x 10 cm, (2 inches x 4 inches) at least 1.5 metres (approx 5 feet) high will contain the birds. An electrified wire installed on the top inside of this type of fence will prevent ostriches and emus from jumping over. Electrified wires placed on the outside bottom will keep predators from digging under the fence.

Note: We do not recommend using electric fencing to contain chicks. Use either chain link or closely spaced woven wire. Never use barbed wire fencing, as it can cause injury to the birds.

A 2 metre electric high tensile fence used around the perimeter will both contain the birds as well as keep out predators. Use a minimum of 15 wires starting 10 cm from the ground, and 10 cm apart for the first 1.25 metres of height and 20 cm apart for the top 0.75 metres. The "hot" wires should be on the outside of the fence to keep the predators out, while also containing adult birds.

Electric Fence for Deer Containment

Remember deer are wild animals and are not conditioned to human contact. They tend to range over wide areas to forage, are highly motivated to reach food sources, can jump higher than most other animals, spook easily, and are prone to predator attacks.

For these reasons, deer need fencing that provides both a physical and psychological barrier like electric high tensile fence. An electrified high tensile fence is the best choice because it can be tall, durable and secure, and also serves to keep predators out.

Deer can exhibit excitable behaviour. Unfamiliar and unexpected sounds or stimuli, like unfamiliar people, barking dogs or traffic may create stress and erratic behaviour.

Electrified high tensile fencing is an excellent choice for a permanent perimeter fence. These low-maintenance fences can last up to 20 years and are the best solution for deer control.

Consider using Electro-Wood, the self insulating timber from sustainable hardwood forests on permanent high tensile fences. It consists of posts and droppers so is simple and low cost to install, highly durable and environmentally friendly. The high tensile wire and spring system of a high tensile fence allow it to flex and return to its original shape if run into, making it optimal for deer.

Wire Spacing Guide

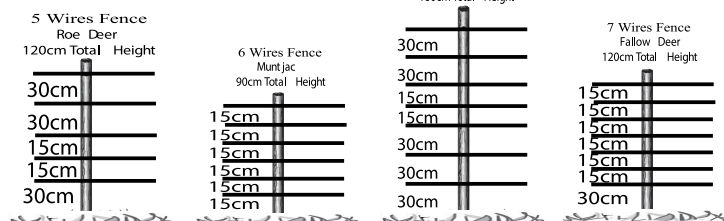

Wire Spacing Guide

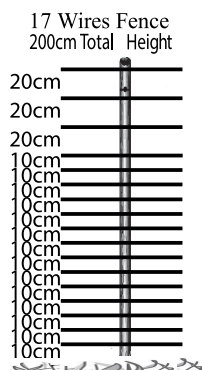

PLANNING INFORMATION

Deer require an energiser that can maintain 3,000 - 4,000 volts on the fence line and a minimum of 1.5 joules of energy, higher on long fences. Voltage levels are affected by vegetation on the fence line, length of fence, and diameter of wire.

For farmed deer, wire spacing should be close enough to prevent the animal from stepping through or putting its head between the wires. Attach seven to nine wire strands to posts that stand at least 2 metres above ground. Be sure that wires are placed near the nose level of the animal. Use a low impedance fence controller.

Note: To prevent jumping, an electrified top wire above the deer head is recommended.

FAQS

What do I need to consider in setting up an electric fence for llamas?

Llamas are fairly easy to contain and rarely try to escape, especially if there is more than one llama fenced in.

Electric fence is the safest fence to use for llamas, as it easily contains the llamas while keeping out any predators. It is recommended to have secure, tight fencing at least 1.25 metres high for perimeter fence, as it will provide safety and security for the llamas and crias (baby llamas).

At times, internal temporary fencing is recommended to separate the breeding males and females and the newly weaned crias.

Are electric fence systems safe for containing ostrich?

Electric high tensile fence systems work well for ostriches as an external perimeter fence, especially where predators are a problem. It is also effective to place an electric wire at the top and bottom of an existing mesh or chain link fence to keep out predators (wire is on the outside of the fence) or to keep the ostriches from jumping over the fence, particularly if the fence less than 2 metres high (wire is on the inside of the fence).

That being said, electric fences may not be the best overall solution for ostriches, as these birds have a tendency to reach over, through or under fencing, which could risk their getting caught in electric wires. Chain link or closely meshed woven wire fences 2 metres high (6 feet) are the safest and most effective.

Never use barbed wire fencing, as it can cause damage to the birds.

Why do you recommend at least a 2 metre electrified high tensile fence for deer and elk?

Deer and elk are not easily domesticated - they are accustomed to roaming where they please, which is usually to food sources. Since they are strong jumpers, they can easily clear a fence that is their height. In addition, they may "test" the electric fence by running into it to get out, so fence needs to be durable and resilient to pressure.

Electric high tensile fence is the ideal solution since it is long lasting, extremely strong, and will maintain its shape even if run into. It can easily be built to 2 metre or taller heights.

AC Electric Fence Components

Here you need for AC model energizer

- 1 Fence Energizer
- 2 Fence Leads
- 3 Earth Leads
- 4 Earth Rod
- 5 Fence gate
- 6 Fence Handles
- 7 Fence Insulators
- 8 Lighting Protection
- 9 Fence post
- 10 Fence Wires/Ropes/Tapes
- 11 wire Tightener
- 12 Warning Sign
- 13 Corner Post

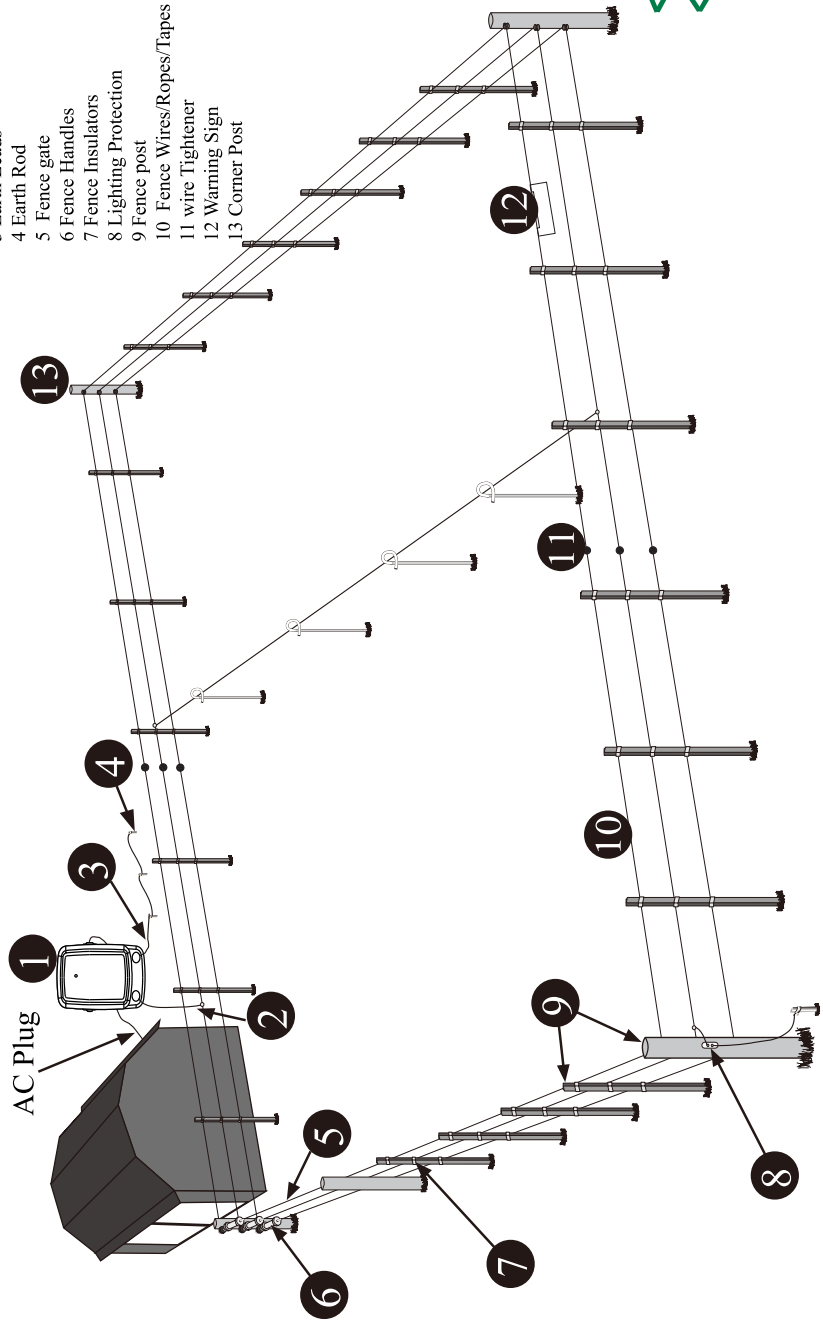

ELECTRIC FENCE ENERGIZER 12

DC Electric Fence Components

Here you need for DC model energizer

- 1 Fence Energizer
- 2 Fence Leads
- 3 Earth Leads
- 4 Earth Rod
- 5 Fence gate
- 6 Fence Handles
- 7 Fence Insulators
- 8 Lighting Protection
- 9 Fence post
- 10 Fence Wires/Ropes/Tapes
- 11 wire Tightener
- 12 Warning Sign
- 13 Corner Post
- 14 Solar Panel
- 15 Battery

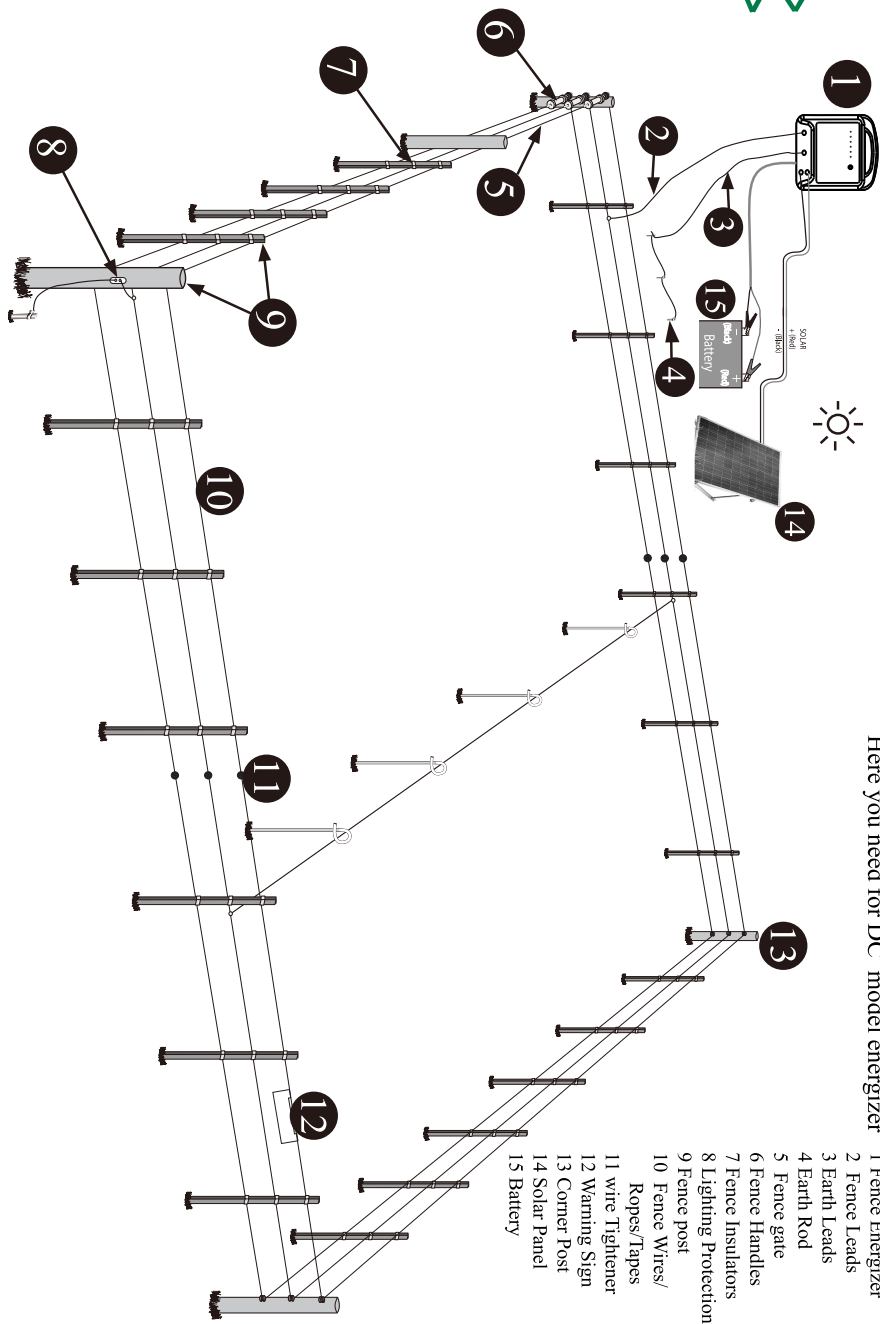

13 ELECTRIC FENCE ENERGIZER

OVERVIEW

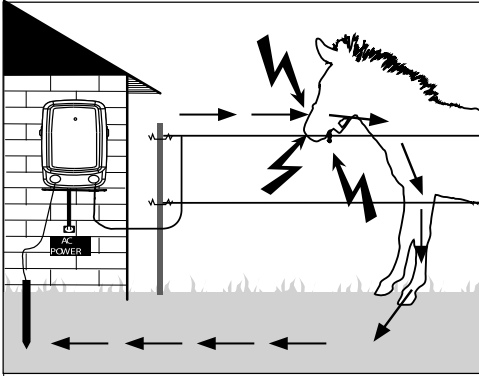

The energiser may be used outdoors only in conjunction with an electric fence to keep animals in/out as required.

The animal receives a shock when it completes the circuit between the fence and ground.

The fence consists of current-carrying wires and requires conductive (wet) soils.

For poorly conductive soil or wild animals several fence lines are used.

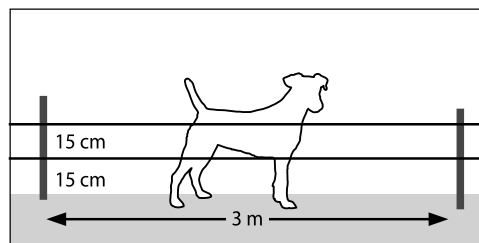
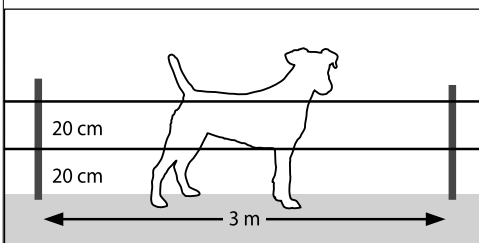
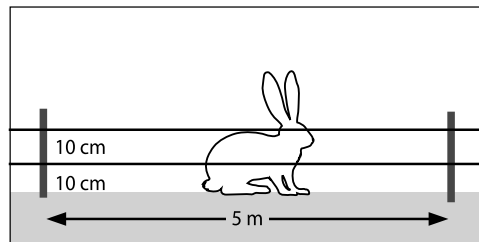
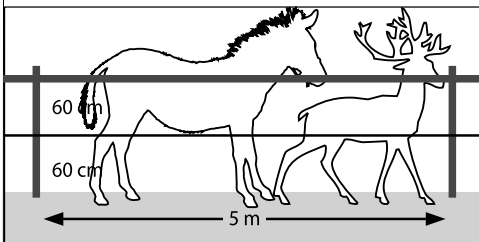
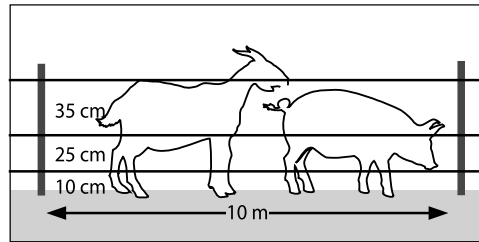
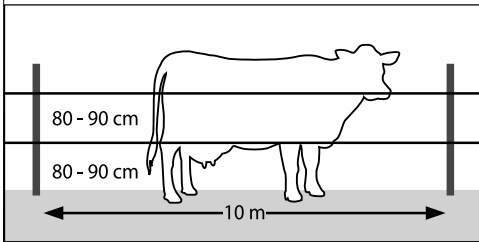

INSTALLATION

Mains Powered Energisers

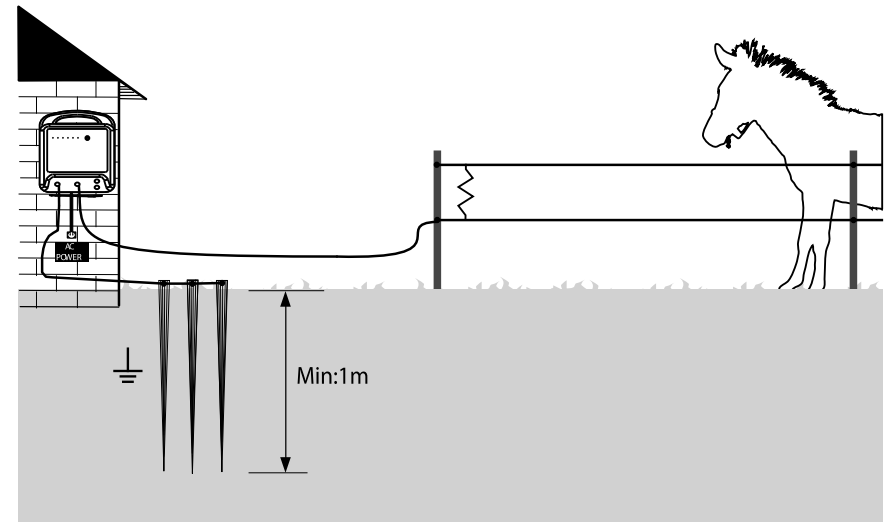

AC POWER

1. Mount the energiser vertically in an area which is protected from the weather.
Do not handle PVC cords when the temperature is below +5 degrees centigrade.
2. Connect the ground terminal to your ground system. The Ground Rods must have a minimum length of 1 meter.
TIP: For poor condition's (sand, gravel, dry soil,) increase the number of earth spikes.
3. Connect the fence terminal to fence line using a fence lead.
4. Operation of the device will commence automatically when connected to the power source.

⚠ WARNING

Electric fence energiser must not be located in fire-hazardous areas such as barns, stables etc.

⚠ WARNING

To prevent lightning damage, the fence lead into the building must be fitted with a lightning arrester (spark gap on lightning arrester must be connected to earth).

INSTALLATION

Battery & Solar Energisers

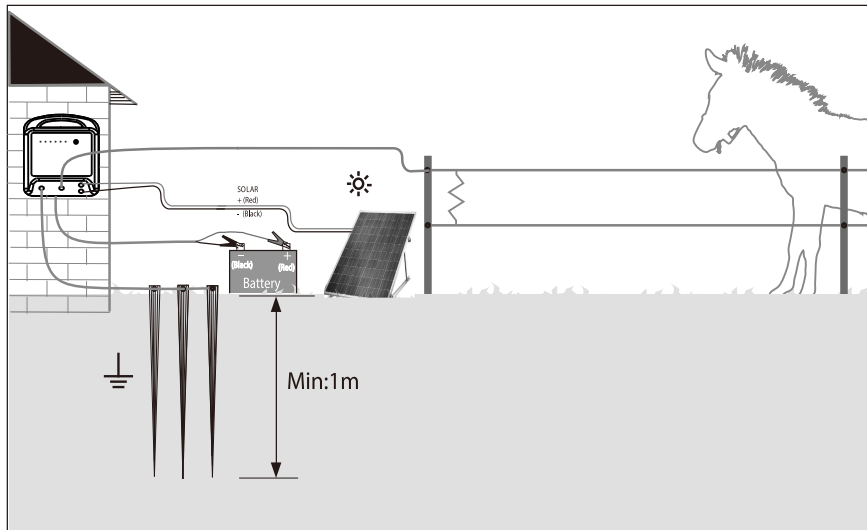
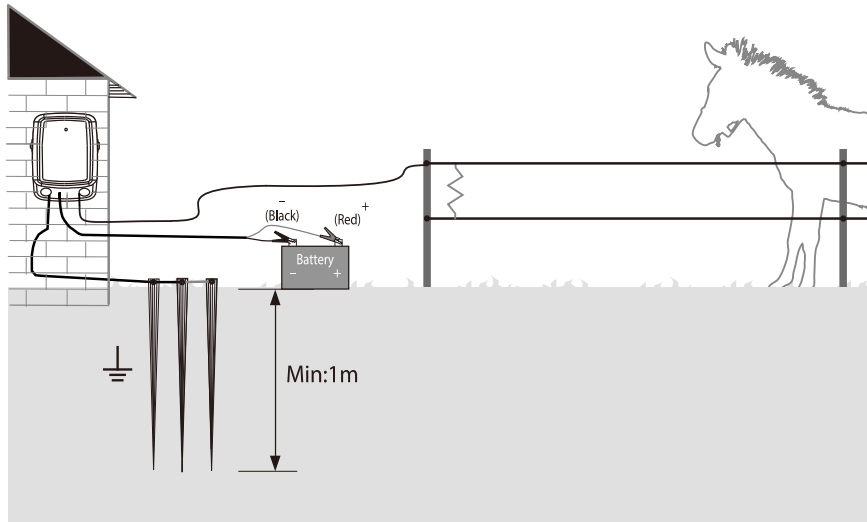

VOLTAGE OUTPUT INDICATOR

The LEDs on the unit show the percentage of voltage loss.

6 LEDs - 100% minimum voltage loss and fence is working to optimum performance.

1 LED - 5% high voltage loss due to factors such as vegetation contact, poor insulators etc.

Fence must be checked.

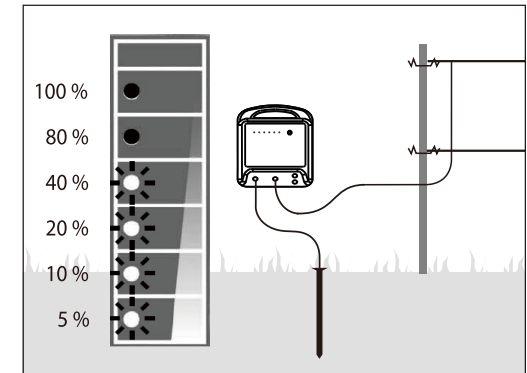

Grounding system check

1 To check the ground system a heavy load must be placed on the fence, by grounding out with a good conductor such as a metal rod (as shown)

2. Check the voltage on the ground system, if anything near or over 1000 volts is flowing between the metal rod and the ground rod, the ground system is inadequate.

3. eg., when the metal rod is placed against the fence -- if all LEDs go out you have a good ground system, if the LEDs remain lit the length or amount of the ground rods used must be increased.

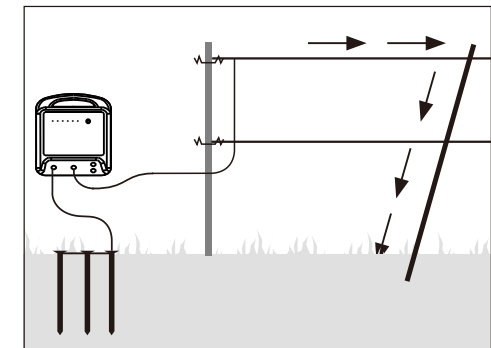

SAFETY



Please read the instructions carefully before operating.

Behave in a responsible manner and treat an electric energiser with respect. The safety of those around must be taken into consideration, as the operator is responsible for any accident or danger to third parties.

Never Use electric fencing where it is likely to be touched by children or infants.

Where small children are likely to access a fence, the duty care requires some form of obstacle such as a one meter high chain link or agricultural mesh fence.

MAINTENANCE

MAINTENANCE

Before performing any maintenance, disconnect the device from the power source

Equipment and fence line should be inspected regularly to ensure correct functioning.

Device should be cleaned REGULARLY, at the same time check wire connections.

Battery: Check electrolyte once a fortnight.

Use a voltage tester to check the fence line everyday.
This will highlight potential before the animals find them.

If the power supply cord is damaged, it must be replaced by a special cable, which is available from the manufacturer or its Vendors.



Damaged and / or discarded appliances must be delivered to the intended recycling points.

Never dispose of household waste! Batteries must be brought to your nearest recycling centre.

REQUIREMENTS FOR ELECTRIC ANIMAL FENCES

Electric animal fences and their ancillary equipment must be installed in a way, operated and maintained to minimize the risks to persons, animals or their environment.

Construction of electric animal fences, leading to probable complications with people, must be avoided.

ATTENTION

Touching electric fences should be avoided, especially with the head, neck or upper body. Do not climb over the fence, through the fence or under the fence. To pass through the fence, gate or other point of transition is to be used.

An electric animal fence must not be supplied by two separate electric fence units or from independent fence circuits of the same electric fence unit.

In the case of two separate electric animal fences, (each powered by a separate unit) the distance of the wires between the two electric fences must be at least 2.5 meters.

If this gap is closed, this must be done by using a non-electrical conductive material or an isolating metal barrier.

Barbed wire or razor wire must never be used as part of the electric fence circuit.

REQUIREMENTS FOR ELECTRIC ANIMAL FENCES

Earthing site

Select an earthing site that is regularly moist, at least 10 metres (33 ft) away from:

- an earth stake for another electrical system
- an telephone earth stake
- any plumbing system including disused systems
- any building using structural or reinforcing metal in contact with the ground.

Finding moist ground may require siting of the earth system some distance away from the energiser.

Connection lines, which run inside buildings must be insulated.

This can be achieved by using insulated high voltage cables.

Insulated underground wires are less susceptible to damage. Feed wires must be insulated. Insulated cables should be buried 300mm (1 ft) underground. For further protection where there is heavy traffic flow or metalised gateways, underground lead-out wires should be fed through low density pipe.

Do not use ordinary plastic coated electrical cable under gateways. When buried in soil and subject to voltages typical of electrical fences, it deteriorates within a few years and the fence becomes very effectively earthed.

Connecting cables must not be ran in the same Electrical Conduit as networks supply lines, communication lines or Data lines as this will cause interference.

Connecting leads and electric fence wires shall not cross above overhead power or communication lines.

Crossings with overhead cables shall be avoided wherever possible.
If connecting leads and electric fences are installed near an overhead powerline the clearances shall be:

Voltage of the high voltage line (V)	Distance (m)
≤1 000	3
> 1 000 and ≤33 000	4
> 33 000	8

If connecting leads and electric fence wires are installed near an overhead power line, their height above ground shall not exceed 2 meters. This height applies either side of the orthogonal projection of the outermost conductors of the power line on the ground surface, for a distance of 2 meters for power lines not exceeding 1000V - 15 m for power lines exceeding 1000V.

Electric fences intended for deterring birds, household pet containment or training animals such as cows need only be supplied from low output energisers to obtain satisfactory safe performance.

- A warning plate shall be fitted to every point where persons may gain ready access to the conductors.

Ensure that all mains-powered auxiliary devices connected to the electric animal fence circuit, provide a degree of isolation, which corresponds to the electric fence unit.

Weather protection must be provided for the equipment.

Unless the manufacturer has stated the use of that equipment in the open with no danger of damage to the device.

Declaration of Conformity

We hereby declare that the devices described by its design and construction in the corresponding versions marketed by us with the relevant, basic health and safety.



EN 55014-1:2006+A1:2009+A2:2011

EN 55014-2:1997+A1:2001+A2:2008

EN 61000-3-2:2006+A1:2009+A2:2009

EN 61000-3-3:2008

EN 60335-2-76:2005+A12:2010

EN 60335:2012

EN 62233:2008

Rolera LLC. DBA: RedstoneSupply
Address: 1979 C Wiesbrook Dr. Oswego, IL. 60543
Telephone: 815-797-9636
Mail: sales@redstonesupply.com
www.Redstonesupply.com