

IFP105S

Commercial Touch Display User Guide

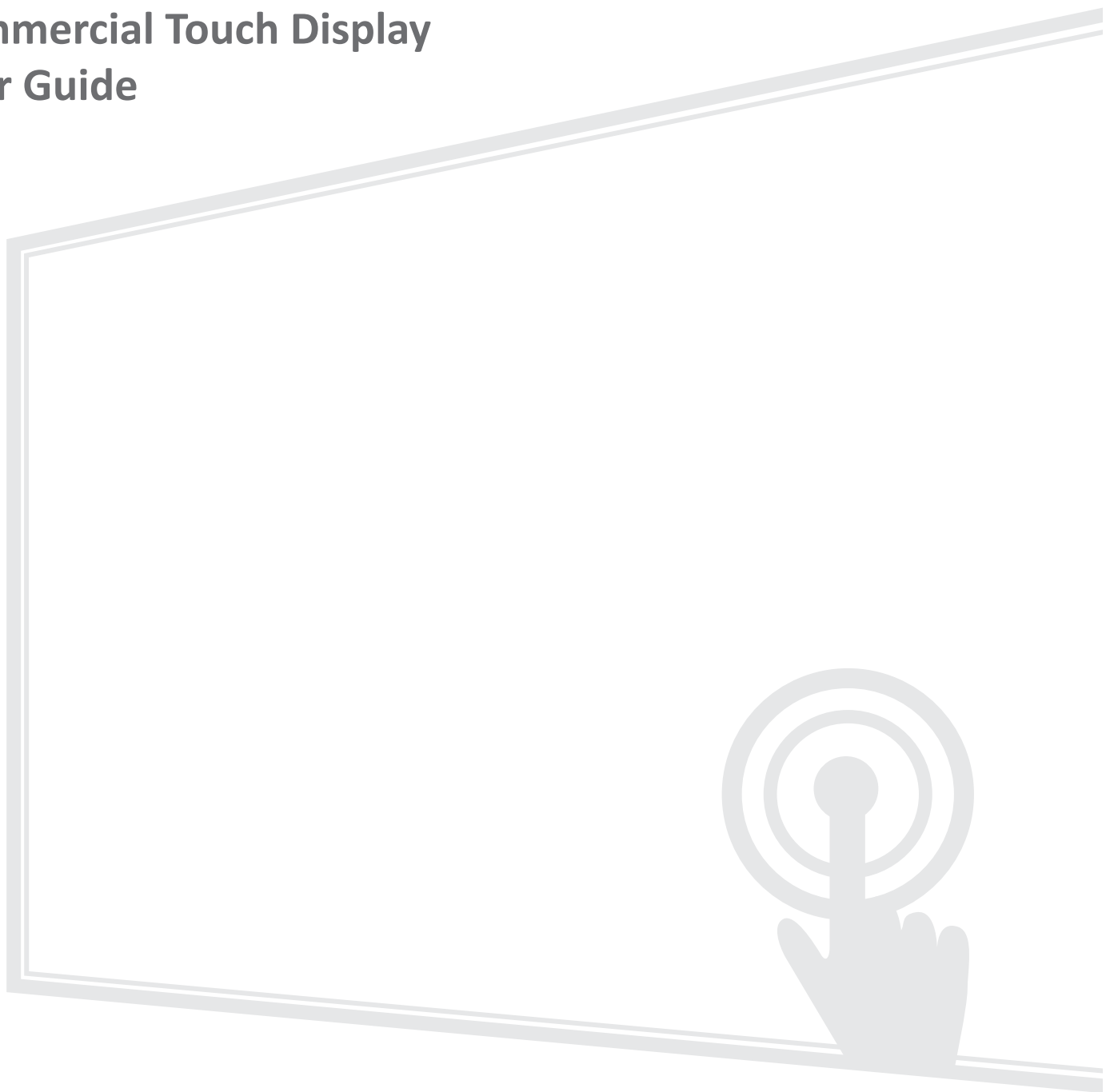

IMPORTANT: Please read this User Guide to obtain important information on installing and using your product in a safe manner, as well as registering your product for future service. Warranty information contained in this User Guide will describe your limited coverage from ViewSonic® Corporation, which is also found on our web site at <http://www.viewsonic.com> in English, or in specific languages using the Regional selection box of our website.

Model No. VS19390
P/N: IFP105S

Thank you for choosing ViewSonic®

As a world-leading provider of visual solutions, ViewSonic® is dedicated to exceeding the world's expectations for technological evolution, innovation, and simplicity. At ViewSonic®, we believe that our products have the potential to make a positive impact in the world, and we are confident that the ViewSonic® product you have chosen will serve you well.

Once again, thank you for choosing ViewSonic®!

Safety Precautions

Please read the following **Safety Precautions** before you start using the device.

- Keep this user guide in a safe place for later reference.
- Read all warnings and follow all instructions.
- Do not use the device near water. To reduce the risk of fire or electric shock, do not expose the device to moisture.
- Never remove the rear cover. This display contains high-voltage parts. You may be seriously injured if you touch them.
- Avoid exposing the device to direct sunlight or other sources of sustained heat.
- Do not install near any heat sources such as radiators, heat registers, stoves, or other devices (including amplifiers) that may increase the temperature of the device to dangerous levels.
- Use a soft, dry cloth to clean the external housing. For more information, refer to the "Maintenance" section.
- When moving the device, be careful not to drop or bump the device on anything.
- Do not place the device on an uneven or unstable surface. The device may fall over resulting in an injury or a malfunction.
- Do not place any heavy objects on the device or connection cables.
- If smoke, an abnormal noise, or a strange odor is present, immediately turn the device off and call your dealer or ViewSonic®. It is dangerous to continue using the device.
- The device is a monitor with an LED backlight intended for general office use.
- Do not attempt to circumvent the safety provisions of the polarized or grounding-type plug. A polarized plug has two blades with one wider than the other. A grounding-type plug has two blades and a third grounding prong. The wide blade and the third prong are provided for your safety. If the plug does not fit into your outlet, obtain an adapter and do not attempt to force the plug into the outlet.
- When connecting to a power outlet, DO NOT remove the grounding prong. Please ensure grounding prongs are NEVER REMOVED.
- Protect the power cord from being treaded upon or pinched, particularly at the plug, and at the point where it emerges from the equipment. Ensure that the power outlet is located near the equipment so that it is easily accessible.

- Only use attachments/accessories specified by the manufacturer.
- When a cart is used, use with caution when moving the cart/equipment combination to avoid injury from tipping over.
- Disconnect the power plug from the AC outlet if the device is not being used for a long period of time.
- Place the device in a well-ventilated area. Do not place anything on the device that prevents heat dissipation.

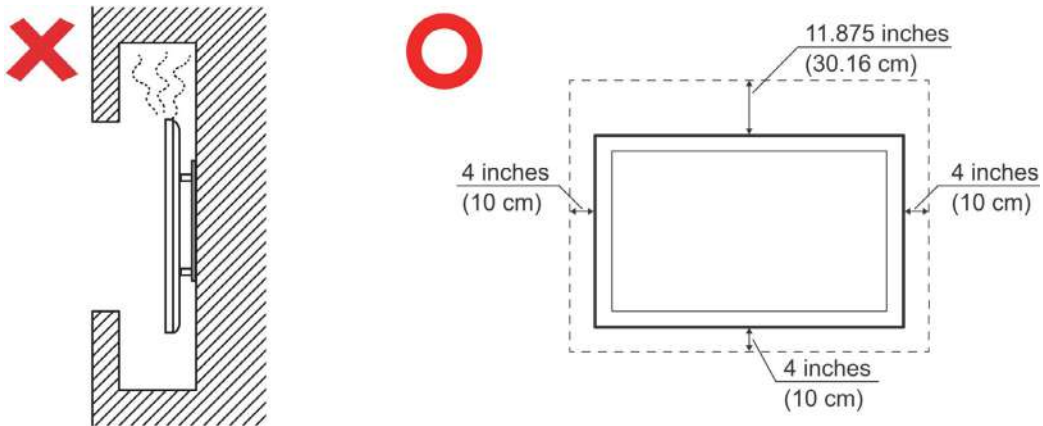

- Refer all servicing to qualified service personnel. Service will be required when the unit has been damaged in any way, such as:
 - » if the power supply cord or plug is damaged
 - » if liquid is spilled onto or objects fall in the unit
 - » if the unit is exposed to moisture
 - » if the unit does not operate normally or has been dropped

Contents

Safety Precautions.....	3
Introduction	9
Package Contents	9
Wall Mount Kit Specifications (VESA)	10
Product Overview	11
Control Panel and Front I/O	12
I/O Panel.....	13
Remote Control	15
Using Gestures	19
Making Connections	21
Connecting External Devices and Touch Connection	21
Type C Connection	21
DisplayPort Connection.....	21
HDMI Connection	21
RS-232 Connection	22
USB and Networking Connections	23
Media Player Connection	24
Audio Connection.....	25
Audio Out	25
Audio Out	25
SPDIF	26
Video Output Connection	27

Using Your ViewBoard.....	28
Powering ON/OFF the Display	28
Initial Launch Setup	29
Toolbar	32
Control Bar	37
On-Screen Display (OSD) Menu - General Settings	40
Input Settings	41
Display Settings	43
Audio Settings	46
Low Blue Light Filter and Eye Health	48
Settings - ViewBoard Input Source	50
Wireless & Network	50
Personal.....	56
Input & Output.....	62
Application	66
System	67
Administrator	85
About.....	94

Pre-installed Applications and Settings.....	95
Record	95
Note	96
vCast	98
Display Group Settings	100
Synchronized Group Screen All the Time	102
Share a Screen to the Display Group (One to Many Casting).....	102
Moderator Mode	103
Broadcast	104
Multiple Screen Sharing	104
Preview Screen.....	104
Touch.....	104
Casting from Windows, MacBook, and Chrome Devices	105
Casting from Android Devices	107
Casting from Apple iOS Devices	110
Connecting to a ViewBoard from a Mobile Device	113
Other Default Applications	114
Browser	114
Finder	115
OfficeSuite.....	117
PIP (Picture-in-Picture).....	118
RS-232 Protocol.....	120
Description	120
RS-232 Hardware Specification	120
LAN Hardware Specification.....	121
RS232 Communication Setting.....	121
LAN Communication Setting	121
Command Message Reference.....	121
Protocol	122
Set-Function Listing.....	122
Get-Function Listing	128
Remote Control Pass-through Mode	136

Appendix.....	139
Specifications.....	139
Display Modes	141
HDMI Mode.....	141
Troubleshooting	142
Maintenance.....	144
General Precautions	144
Cleaning the Screen.....	144
Cleaning the Case	144
Regulatory and Service Information	145
Compliance Information.....	145
FCC Compliance Statement.....	145
Industry Canada Statement.....	145
CE Conformity for European Countries	145
Declaration of RoHS2 Compliance.....	146
ENERGY STAR Statement.....	147
Indian Restriction of Hazardous Substances	147
Product Disposal at End of Product Life	147
Copyright Information	148
Customer Service	149
Limited Warranty	150
Mexico Limited Warranty.....	153

Introduction

Package Contents

- HDMI Cable (3 m) x 1
- Power Cable (by region)
- Remote Control
- AAA Battery
- USB Touch Cable (3 m) x 1
- Touch Pen x 2
- RS-232 Adapter
- Clamp x 5
- Camera Plate x 1
- Screw x 6
- Quick Start Guide
- Compliance Statement

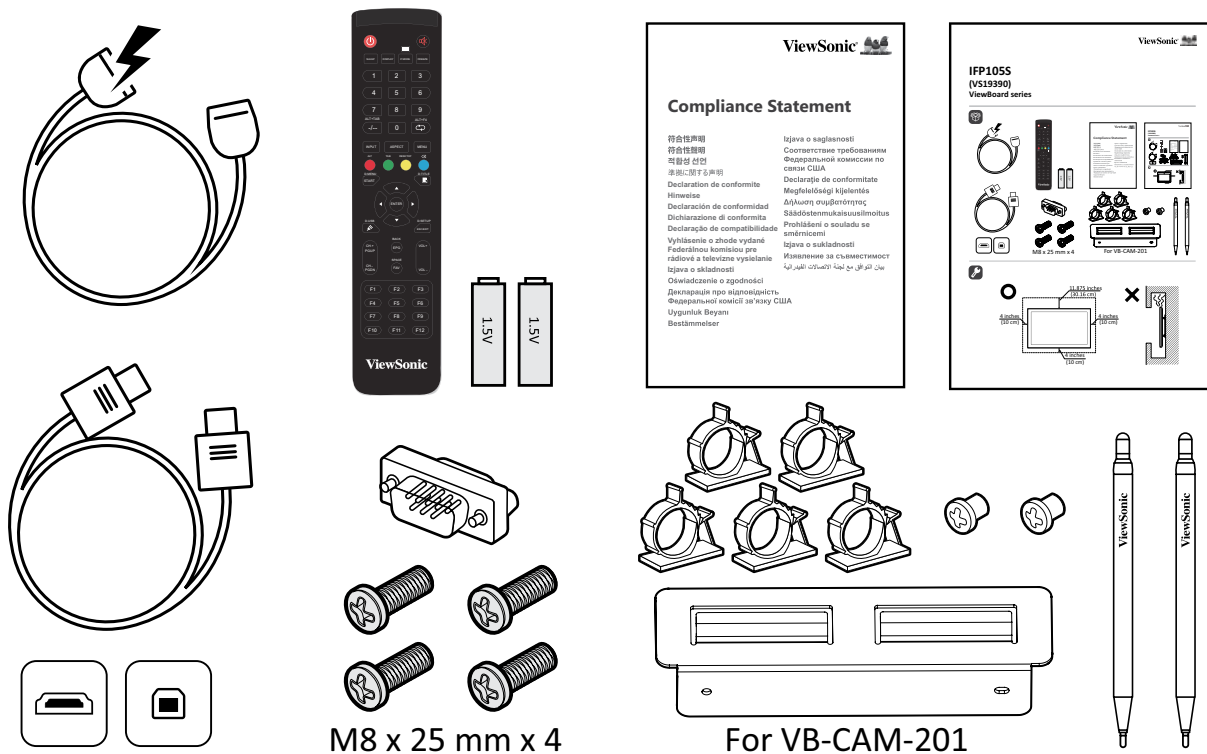

NOTE: The power cord and video cables included in your package may vary depending on your country. Please contact your local reseller for more information.

Wall Mount Kit Specifications (VESA)

NOTE: Please follow the instructions in the wall mount installation guide to install your wall mount or mobile mount bracket. If attaching to other building materials, please contact your nearest dealer.

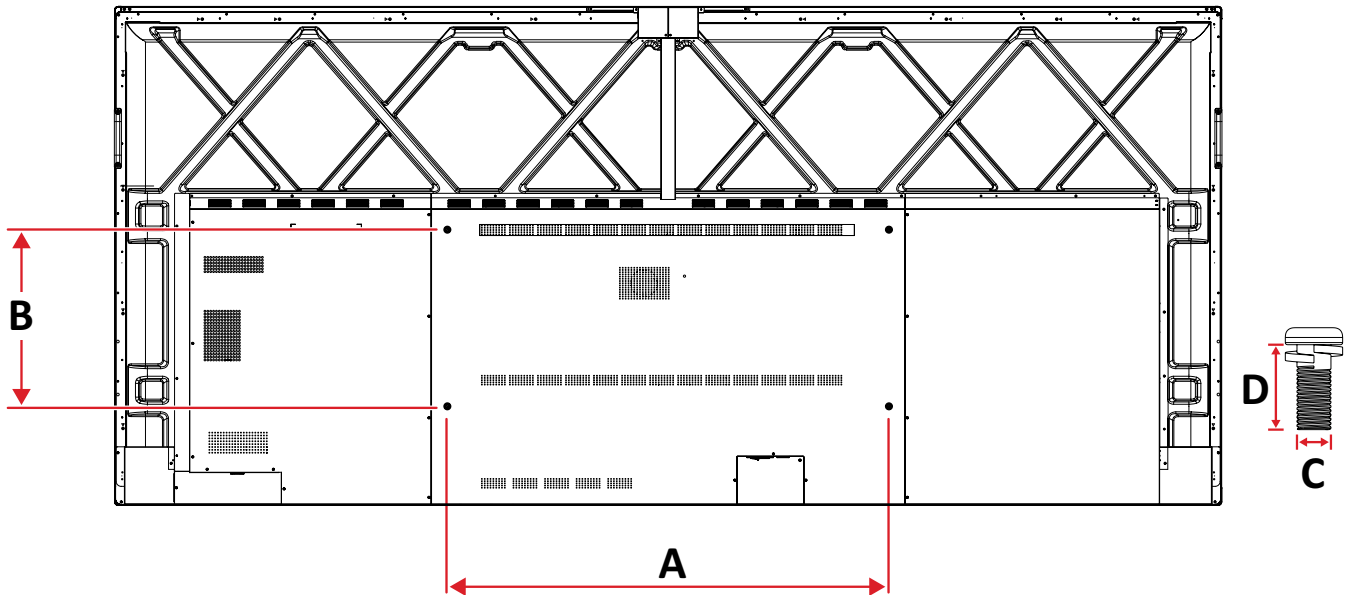

Model	VESA Spec. (A x B)	Standard Screw (C x D)	Quantity
IFP105S	1000 x 400 mm	M8 x 25 mm	4

NOTE: Do not use screws that are longer than the standard dimension, as they may cause damage to the inside of the display.

Product Overview

Front Panel





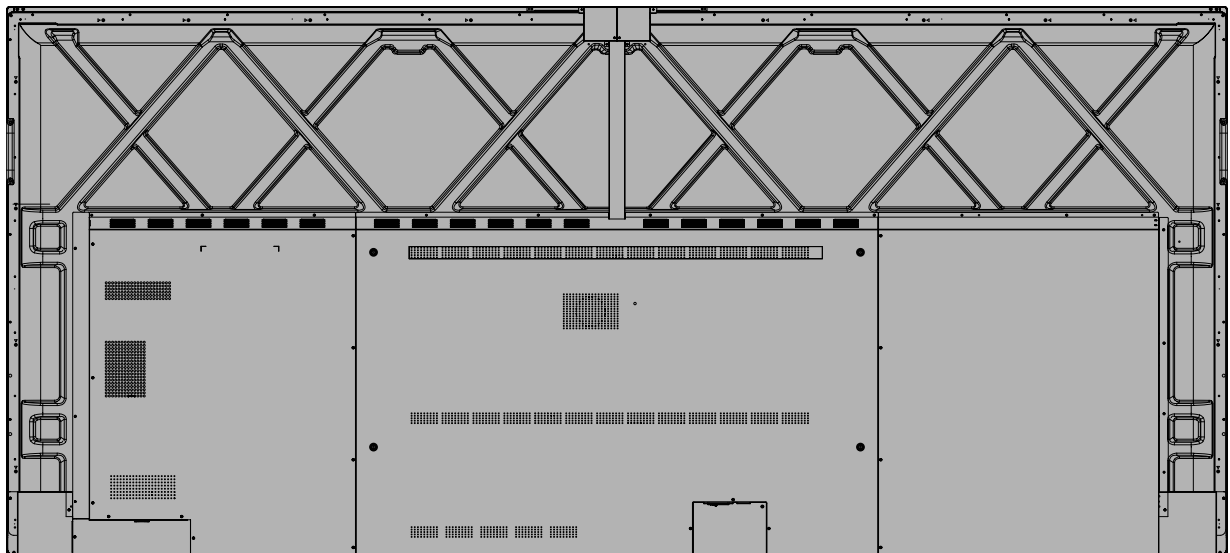

Control Panel and Front I/O

Rear Panel

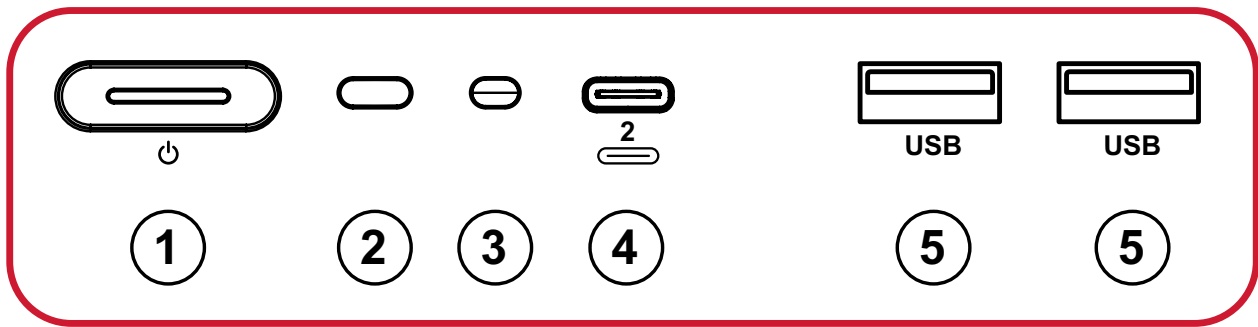

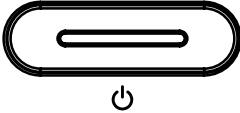
Control Panel and Front I/O



Number	Item	Description
1		<ul style="list-style-type: none"> • Power indicator light. • Press to turn ON the device. • Press to turn OFF/ON the display backlight only. • Press and hold to turn off the device.
2		Remote Control receiver.
3		Ambient Light Sensor to monitor the ambient light.
4		<ul style="list-style-type: none"> • USB Type C Power Delivery (15W, 5.0V~3.0A) • Connect to a PC with USB Type C output.
5		<ul style="list-style-type: none"> • USB Type A input • Connect USB devices such as hard disks, keyboard, mouse, etc. • Automatically switches between PC and external PC.

I/O Panel

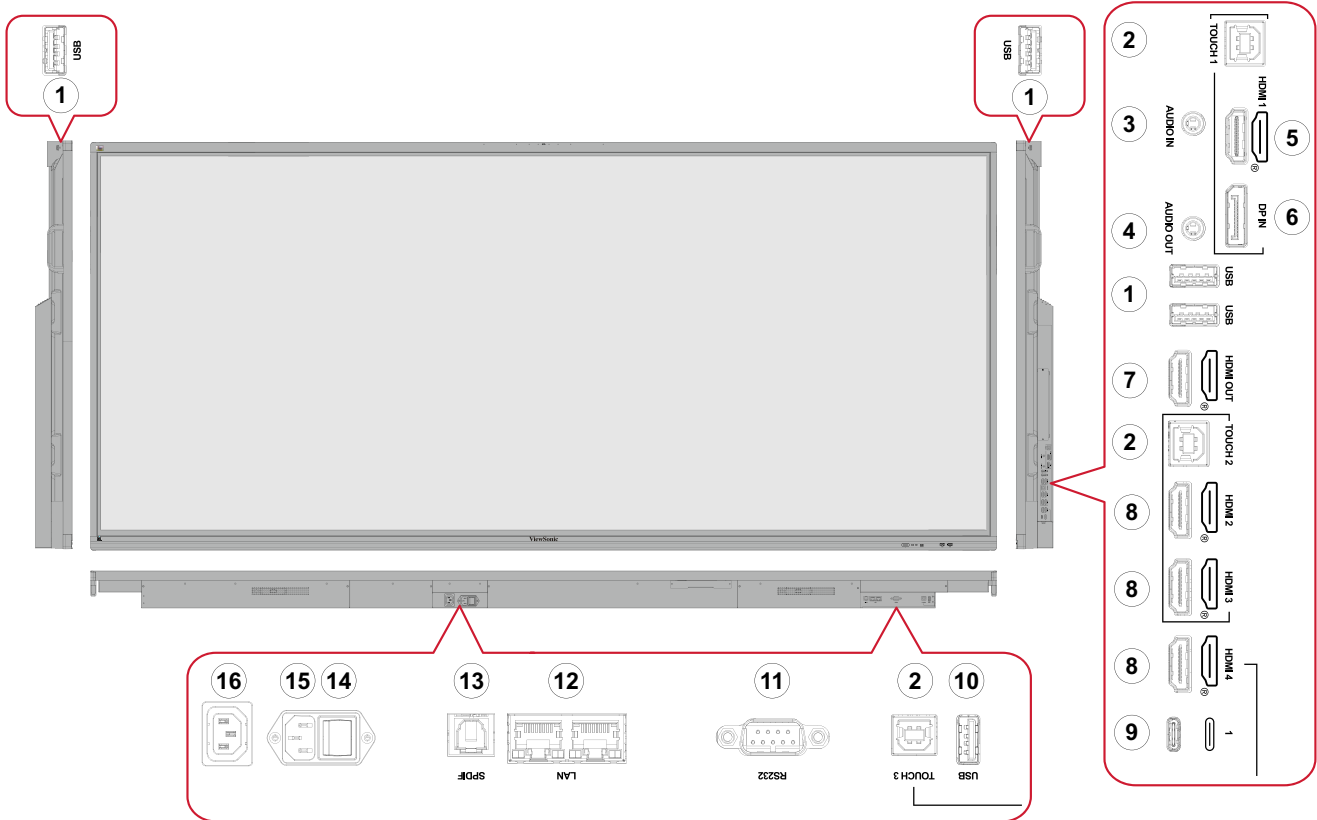

Figure 1

Number	Item	Description
1	USB 3.0	<ul style="list-style-type: none"> • USB Type A input • Connect USB devices such as hard disks, keyboard, mouse, etc. • Automatically switches between PC and external PC.
2	TOUCH 1/2/3	Touch signal output to external PC NOTE: <ul style="list-style-type: none"> • TOUCH 1 supports HDMI 1 and DP IN. • TOUCH 2 supports HDMI 2 and HDMI 3. • TOUCH 3 supports HDMI 4.
3	AUDIO IN	External computer audio input.
4	AUDIO OUT	Audio out to an external speaker.
5	HDMI 1	<ul style="list-style-type: none"> • 5K high-definition input. • Connect to a PC with HDMI output, set-top box, or other video device.
6	DP IN	<ul style="list-style-type: none"> • DisplayPort Input • Connect to a PC or other video device with DisplayPort output.
7	HDMI OUT	Extend content out to another display device.

Number	Item	Description
8	HDMI 2/3/4	<ul style="list-style-type: none"> High-definition input. Connect to a PC with HDMI output, set-top box, or other video device.
9	USB Type C	<ul style="list-style-type: none"> USB Type C Power Delivery (65W, 20.0V~3.25A) DP 1.2 with USB 3.0 return 10M/100M Ethernet
10	USB 2.0	<ul style="list-style-type: none"> USB Type A input For firmware update.
11	RS-232	<ul style="list-style-type: none"> Serial interface For mutual transfer of data between devices.
12	LAN	<ul style="list-style-type: none"> Standard RJ45 (10M/100M/1G) internet For ViewBoard and Slot-in PC use.
13	SPDIF	SPDIF output.
14	Power Switch	Turn ON/OFF AC power supply.
15	AC IN	AC power input.
16	AC OUT	AC power output.

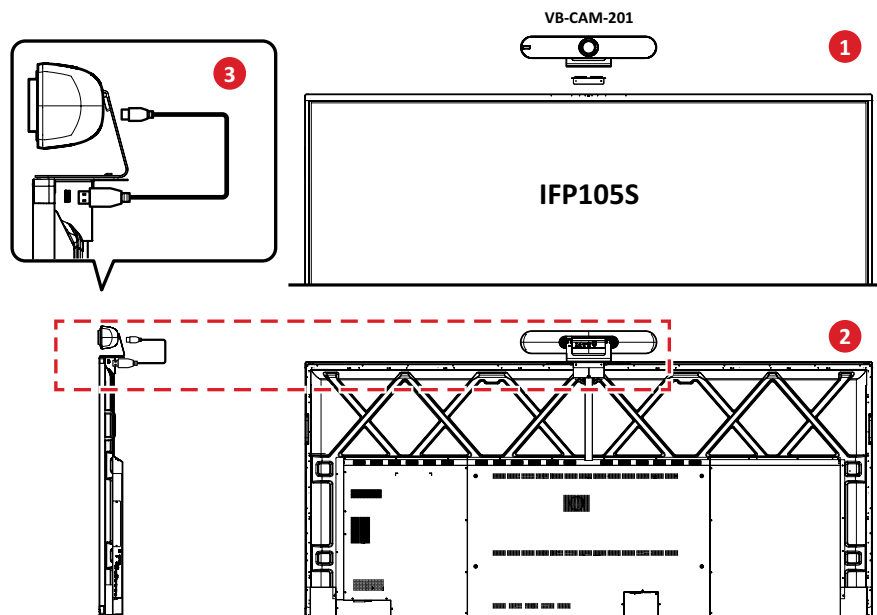
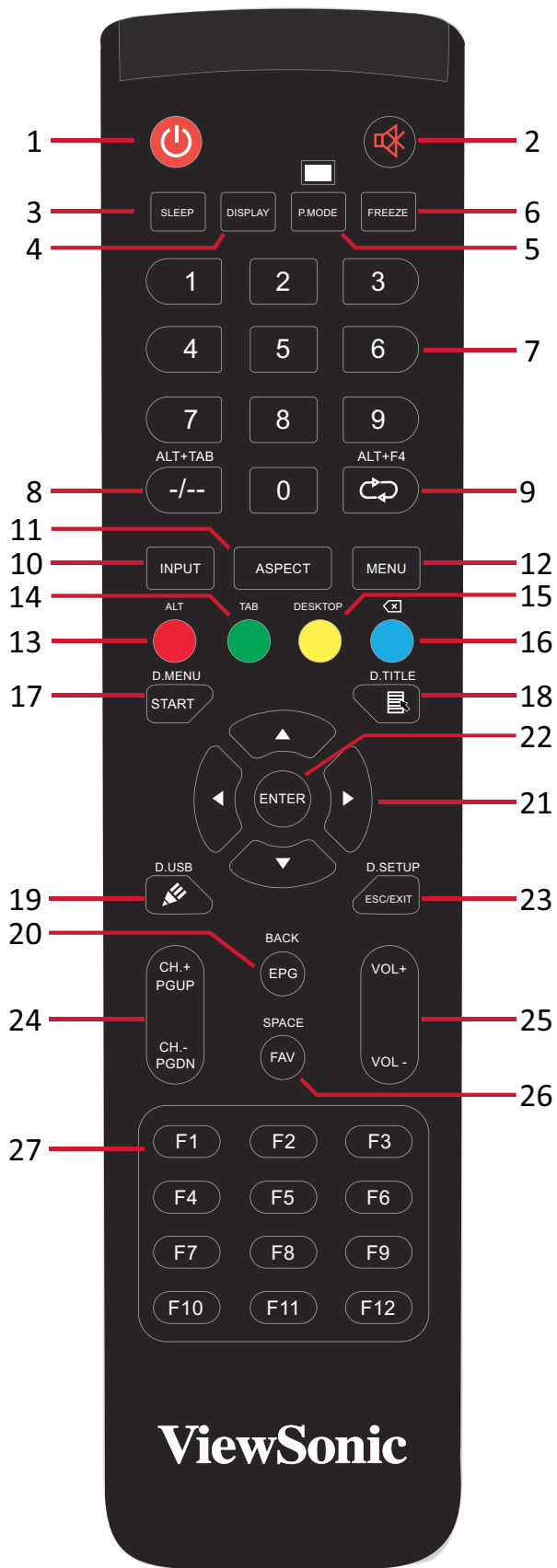











Figure 2

NOTE:

- **Figure 1** - There are two, a numbered (1 2) and unnumbered (≡), versions of the USB Type C port icon label on the Control Panel and I/O for this product line. Both versions' USB Type C ports function the same.
- **Figure 2** - For the best viewing angle, it is recommended to install the USB camera on top of IFP105S and connect the camera to the upper USB port.

Remote Control



Number	Item	Description
1		Power ON/OFF
2		Mute/Unmute
3	SLEEP	Sleep Mode
4	DISPLAY	For Non-Android sources; display current input source information
5	P.MODE	Blank Screen
6	FREEZE	Freeze Screen
7		Numeric input buttons
8	ALT+TAB -/--	Slot-in computer space bar Alt+Tab
9	ALT+F4 	Slot-in computer, close program window
10	INPUT	Input source selection
11	ASPECT	Back to slot-in system main interface
12	MENU	For Android, access Settings; for other sources, access Touch Menu settings
13	Red / ALT	Screen capture
14	Green / TAB	PC ¹ [Tab] button
15	Yellow / DESKTOP	Switch to slot-in PC desktop
16	BLUE/ 	PC ¹ [Backspace] button
17	START / D.MENU	PC ¹ [Windows] button
18	 / D.TITLE	PC ¹ [Menu] button
19	 / D.USB	Writing software setup
20	EPG/BACK	Return button
21	 /  /  / 	Scroll up, down, left, and right
22	ENTER	Confirm selection/state
23	ESC / EXIT / D.SETUP	Shortcut button to exit dialogue boxes
24	CH.+ / PGUP / CH.- / PGDN	CH+: PC previous page CH-: PC next page
25	VOL+ / VOL-	Increase/Decrease volume
26	FAV / SPACE	PC ¹ [Space] button
27	F1-F12	Built-in computer F1 - F12 function button

¹ All computer-related function keys are not available without a slot-in computer.

Inserting Remote Control Batteries

To insert batteries into the remote control:

1. Remove the cover on the rear of the remote control.
2. Insert two “AAA” batteries, ensuring the “+” symbol on the battery matches the “+” on the battery post.
3. Replace the cover by aligning it with the slot on the remote control and snapping the latch shut.

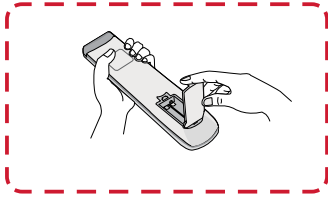

(1)

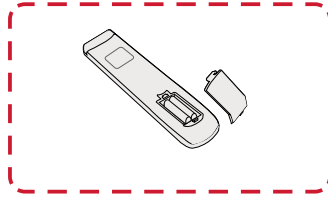

(2)

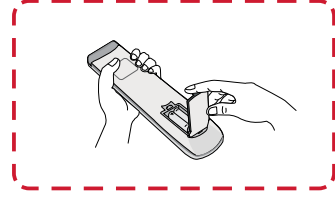

(3)

WARNING: There is a risk of explosion if batteries are replaced with the incorrect type.

NOTE:

- It is recommended that you do not mix battery types.
- Always dispose of old batteries in an environmentally friendly way. Contact your local government for more information on how to dispose of batteries safely.

Remote Control Receiver Range

The working range of the remote control is shown here. It has an effective range of 8 meters, 30° degrees left and right. Ensure there is nothing obstructing the remote control's signal to the receiver.



Using Gestures

Touch gestures allow the user to use pre-determined commands without using a keyboard or mouse. Using gestures on the ViewBoard, the user can select/deselect objects, change the location of an object, access settings, erase digital ink, and much more.

Select and Deselect an Object (Clicking)

Press and release the ViewBoard to select/deselect options or objects. This is like a single, standard left mouse click.

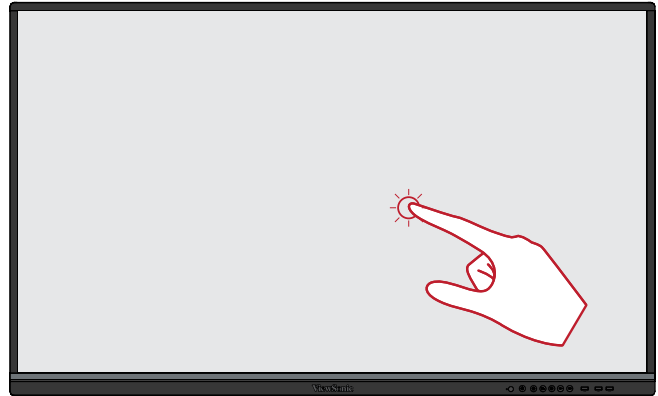

Display Menu Options (Right-Clicking)

Press and hold the ViewBoard with your finger. This is like a single, standard right mouse click.

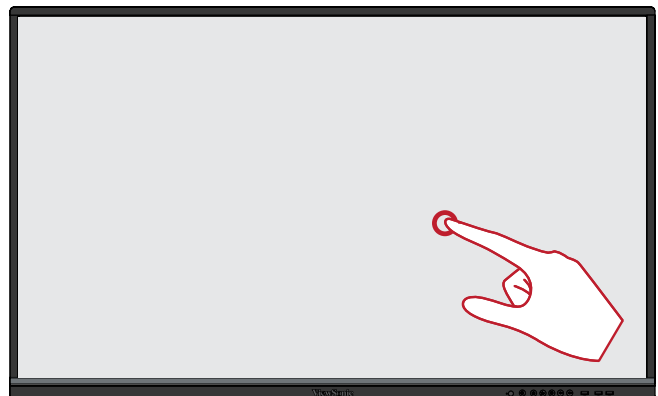

Double-Clicking

Quickly press and release twice in the same location on the ViewBoard. This is like a double, standard left mouse click.

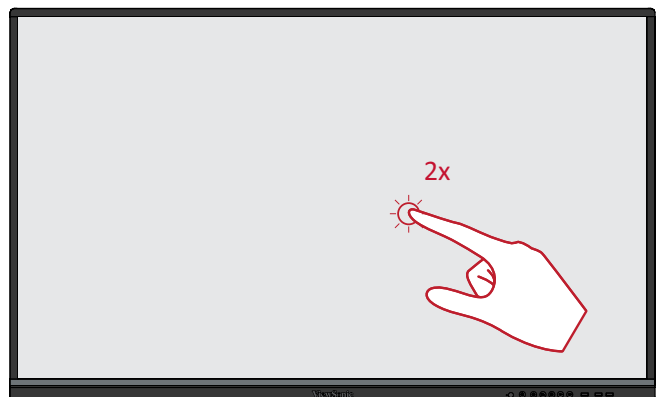

Moving an Object

Press and hold the object on the ViewBoard and slowly drag it with your finger to your desired location.



Erasing Digital Ink

Use your flattened hand, palm, or fist on the ViewBoard and move your hand across the area which you wish to erase.

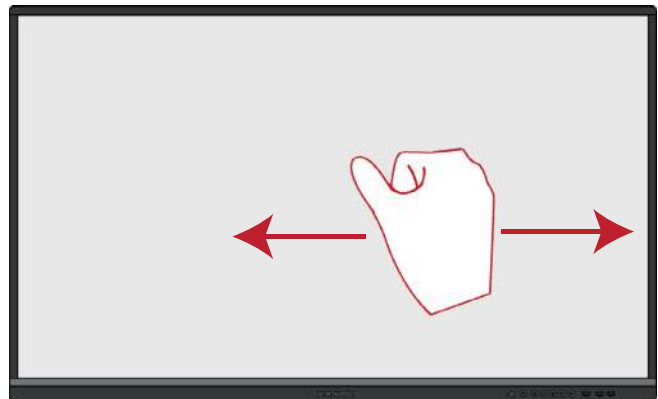

Swipe Up for General Settings

Swipe up from the bottom of the ViewBoard to launch the General Settings.

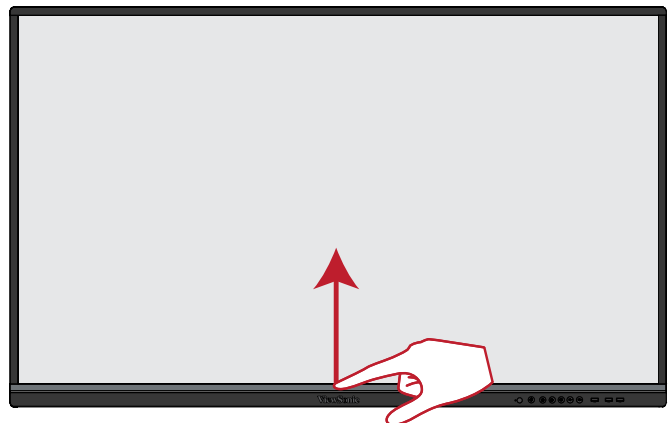

Making Connections

Connecting External Devices and Touch Connection

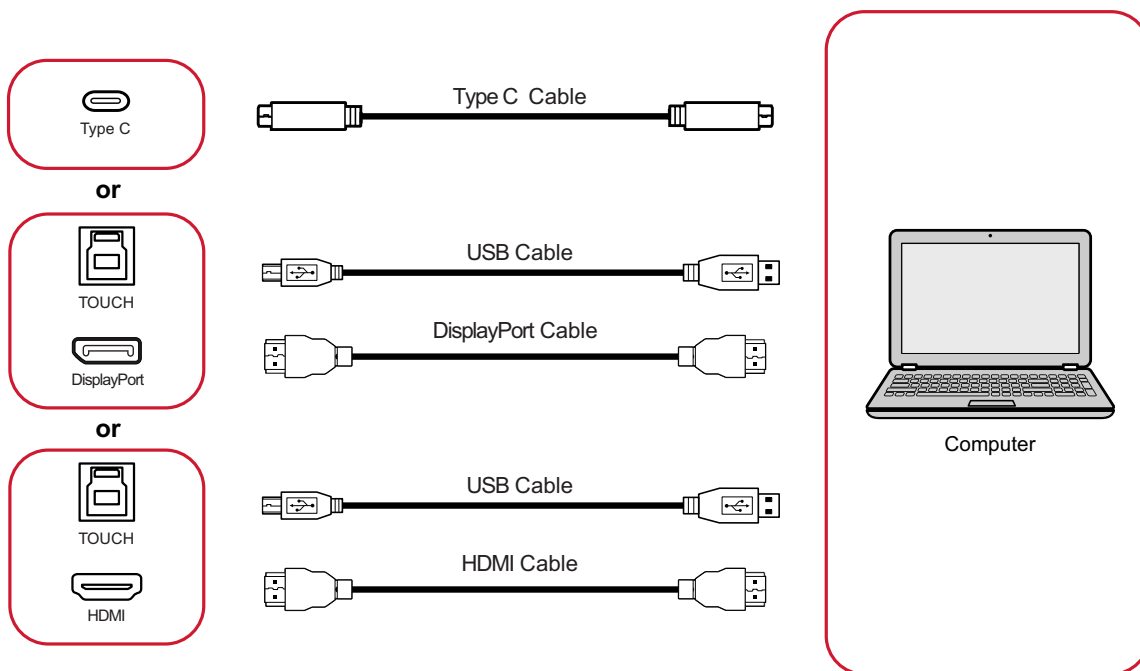

Your external device(s) can be connected in any of the following configurations:

Type C Connection

To connect via Type C:

Connect a Type C cable from your external device to the **Type C** port on the display.

DisplayPort Connection

To connect via DisplayPort:

1. Connect a DisplayPort cable from your external device to the **DP IN** port on the display.
2. Connect a USB cable to the external device from the **TOUCH 1** port of the display.

HDMI Connection

To connect via HDMI:

1. Connect an HDMI cable from your external device to the **HDMI 1/2/3/4** port on the display.
2. Connect a USB cable to the external device from the appropriate **TOUCH** port of the display.

NOTE: The **TOUCH 1** port is for the **HDMI 1** port. The **TOUCH 2** port is for the **HDMI 2** and **HDMI 3** ports. The **TOUCH 3** port is for the **HDMI 4** port.

RS-232 Connection

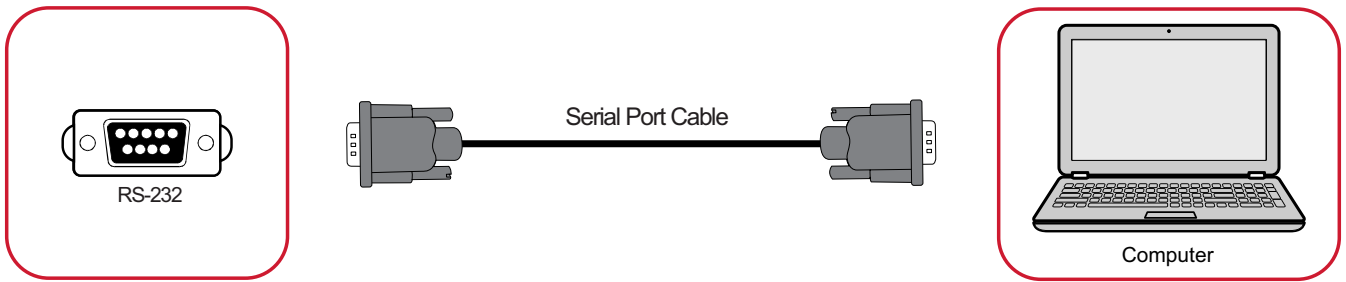

When you use a RS-232 serial port cable to connect the display to an external computer certain functions can be controlled remotely by the PC, including Power ON/OFF, Volume adjustment, Input select, Brightness, and more.

USB and Networking Connections

Just like any PC, it is easy to connect various USB devices and other peripherals to the display.

USB Peripherals

Plug the USB device cable into a **USB** port.

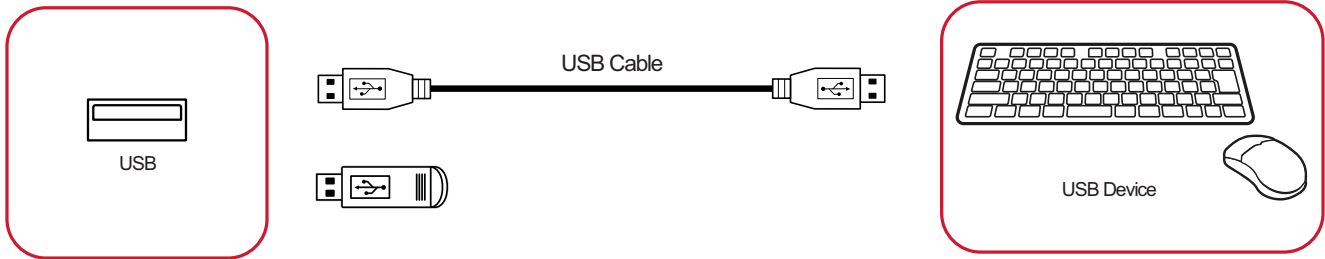

Networking and Modem cables

Plug the network cable into a **LAN** port.

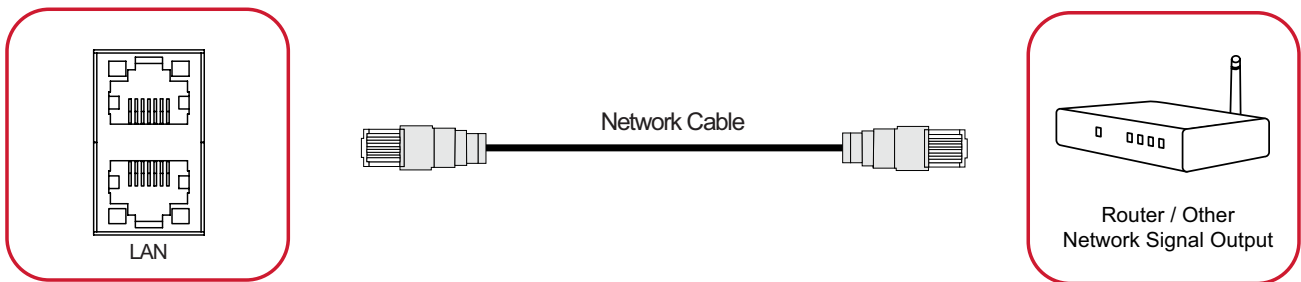

Media Player Connection

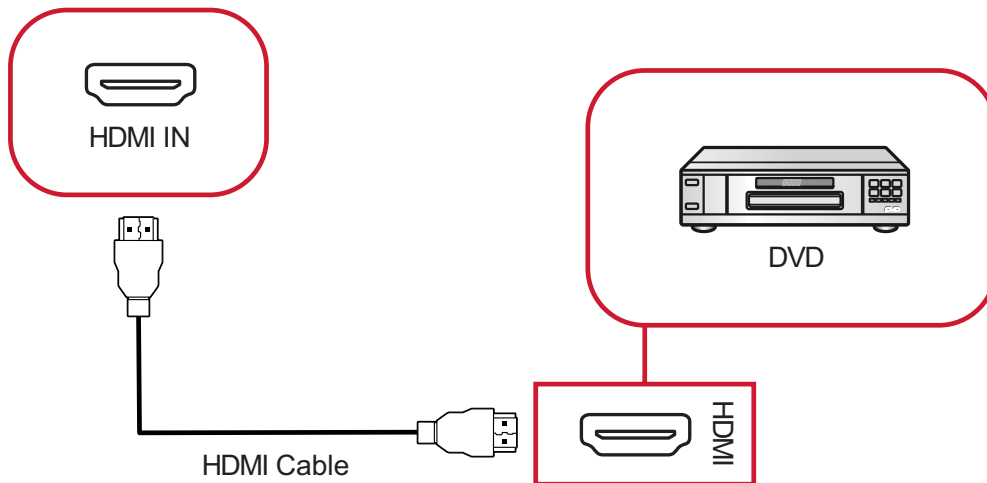

To connect to a media player:

1. Connect the HDMI cable to the **HDMI IN** port on the display and peripheral device.
2. Plug in the power cord of the display, and turn ON the power supply switch.
3. Press the **Power** button on the display to turn the screen ON.
4. Press the **INPUT** button on the remote control and switch to the “HDMI” input source.

Audio Connection

Audio Out

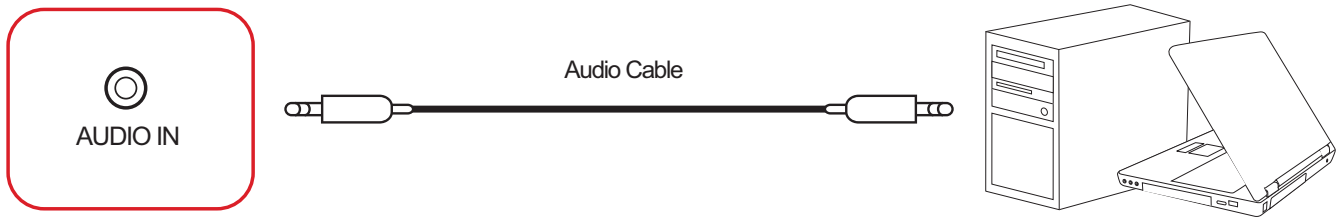

To connect to an external device:

1. Connect an audio cable from the **AUDIO IN** port on the display to your external device.
2. Plug in the power cord of the display, and turn ON the power supply switch.
3. Press the **⏻ Power** button on the display to turn the screen ON.

Audio Out

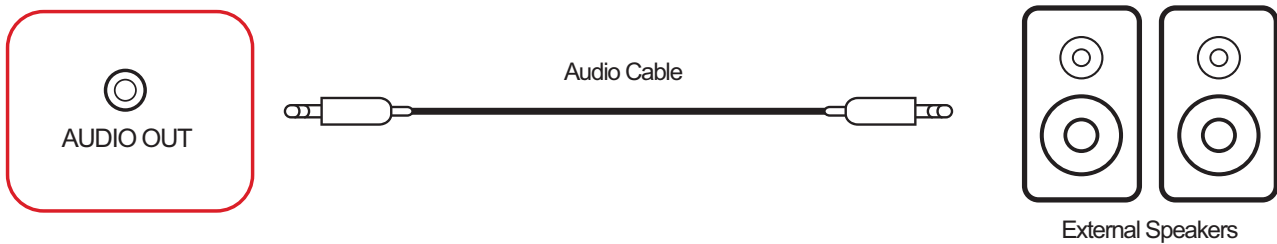

To connect to external speakers:

1. Connect an audio cable from the **AUDIO OUT** port on the display to your external speaker(s).
2. Plug in the power cord of the display, and turn ON the power supply switch.
3. Press the **⏻ Power** button on the display to turn the screen ON.

SPDIF

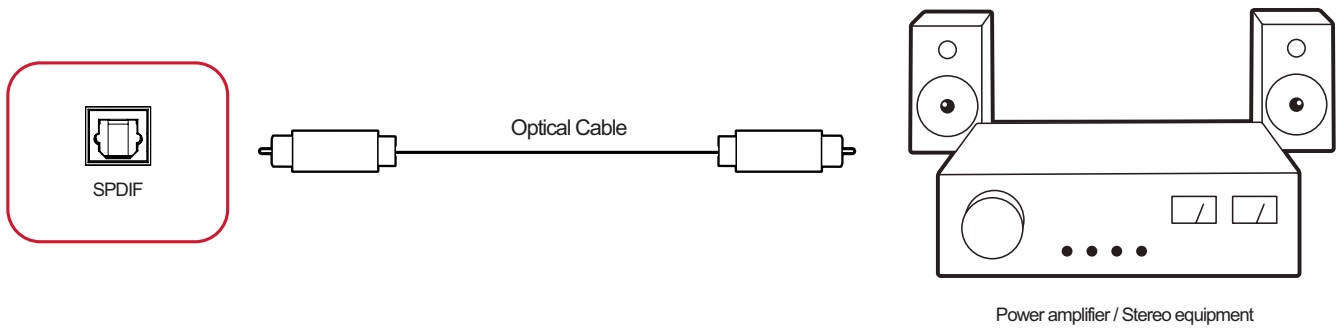

To connect to an external sound system:

1. Connect an optical cable from the **SPDIF** port to your sound system's optical connector.
2. Plug in the power cord of the display, and turn ON the power supply switch.
3. Press the **Power** button on the display to turn the screen ON.

Video Output Connection

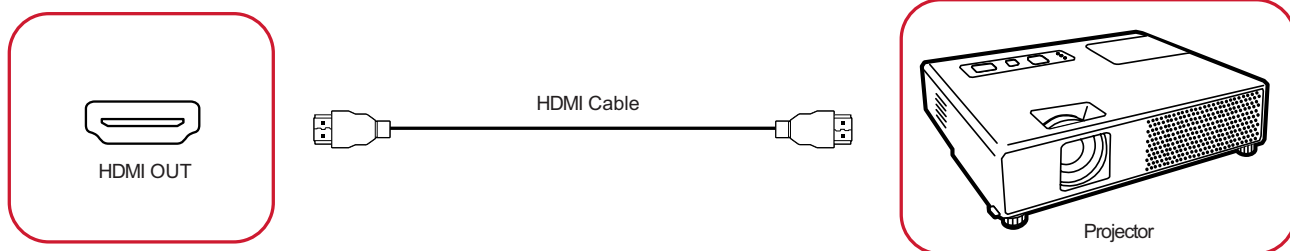

To output video via a display device:

1. Connect an HDMI cable to the **HDMI IN** port of your display device, and the other end to the **HDMI OUT** port of the display.
2. Plug in the power cord of the display, and turn ON the power supply switch.
3. Press the **Power** button on the display to turn the screen ON.

Using Your ViewBoard

Powering ON/OFF the Display

1. Ensure the power cord is connected, plugged into a power outlet, and the power switch is in the “ON” position.



The AC Power input and switch are located at the bottom of the unit.

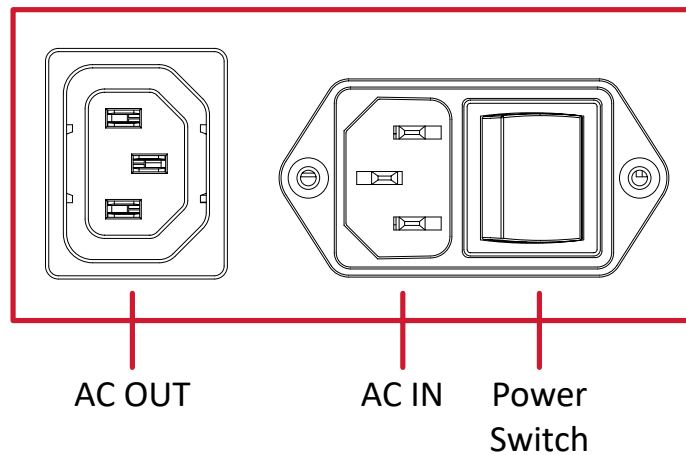

2. Press the **Power** button to turn ON the display.
3. To turn the display OFF, press and hold the **Power** button.

NOTE: **AC OUT** can be connected to another device. However, the output power use must be < 250W.

Initial Launch Setup

When you first turn on the display, an initial setup wizard will launch.

1. Select **Start Setting** to begin the setup wizard.

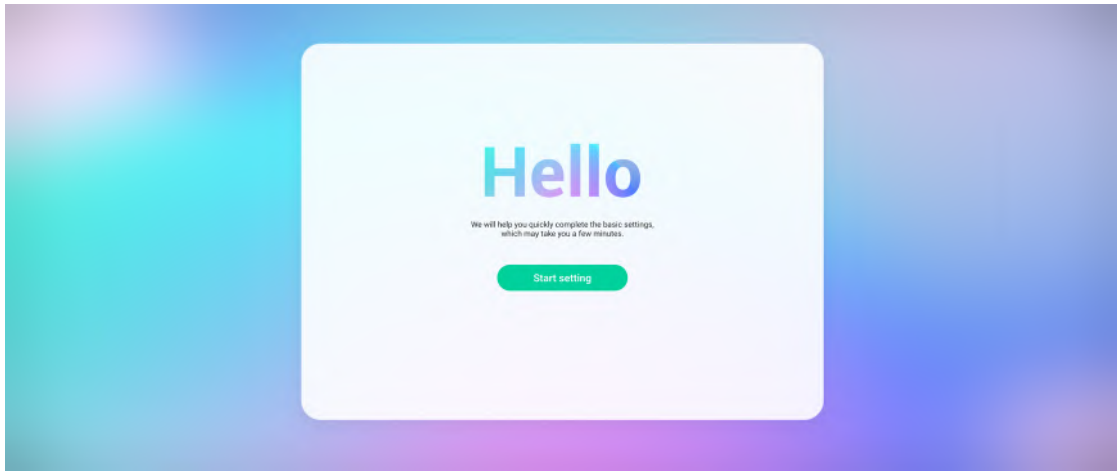

2. Select your Language.

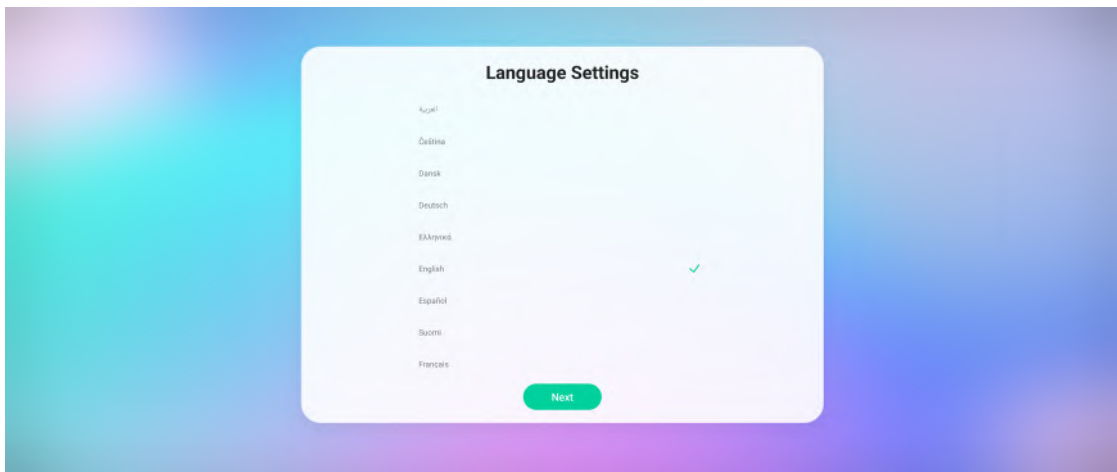

3. Select your Country or Region.

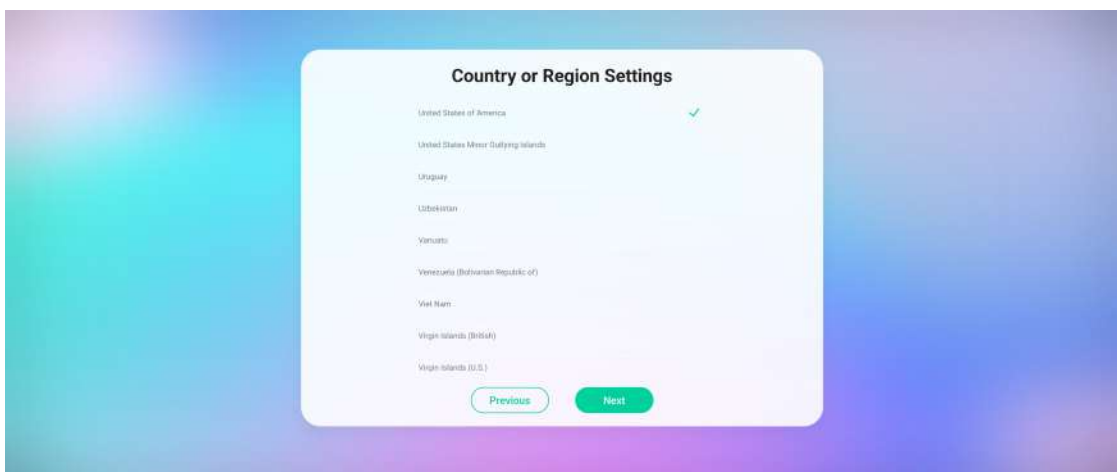

4. Setup and verify your LAN connection.

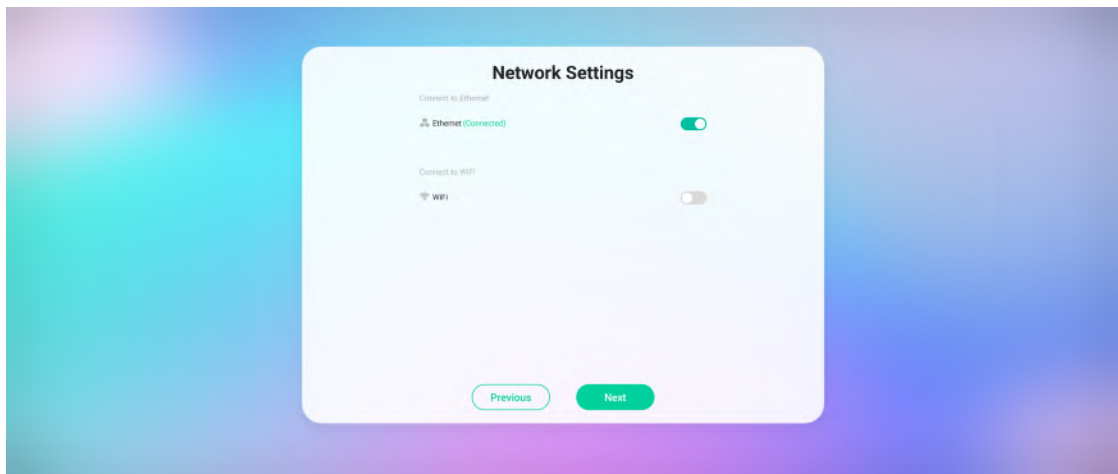

5. Select your Time Zone to set the Date and Time.

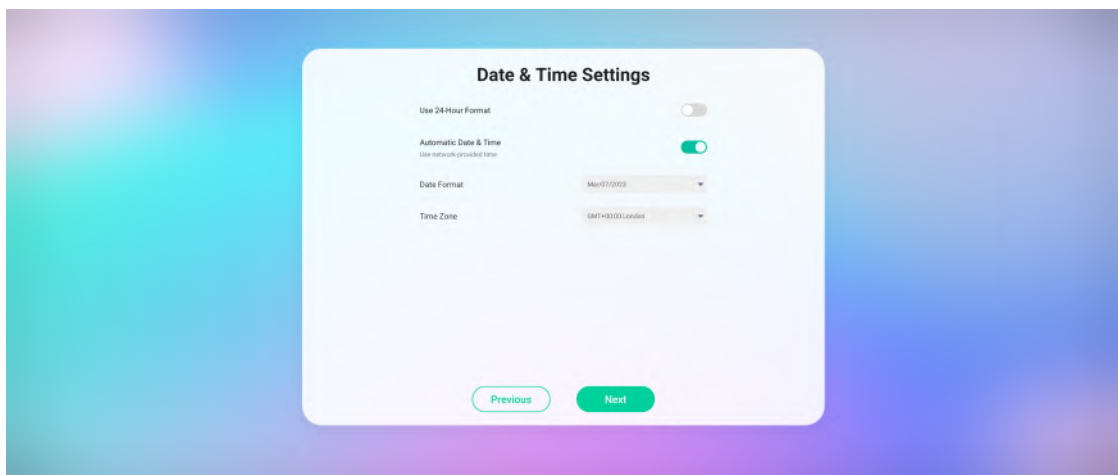

6. Accept or Decline the Privacy and Copyright Protection Terms.

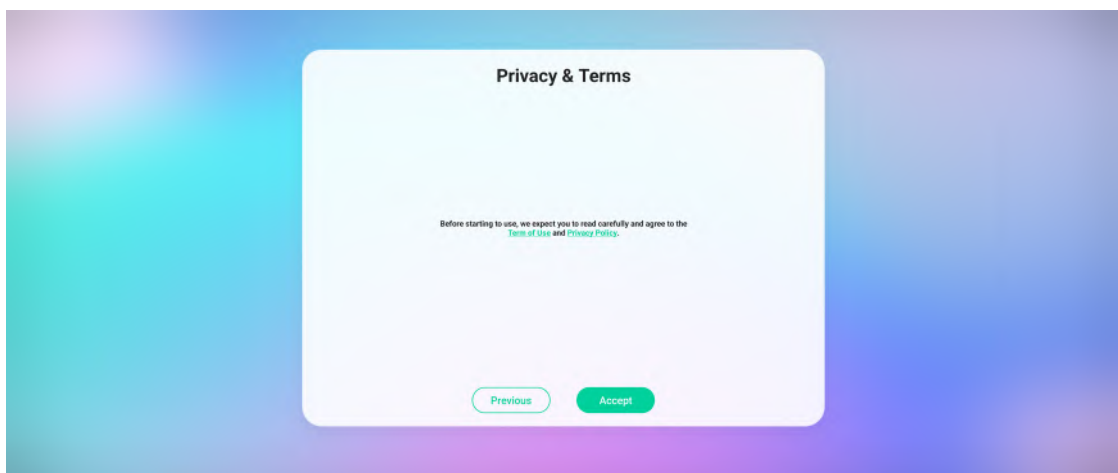

7. Set your device name.

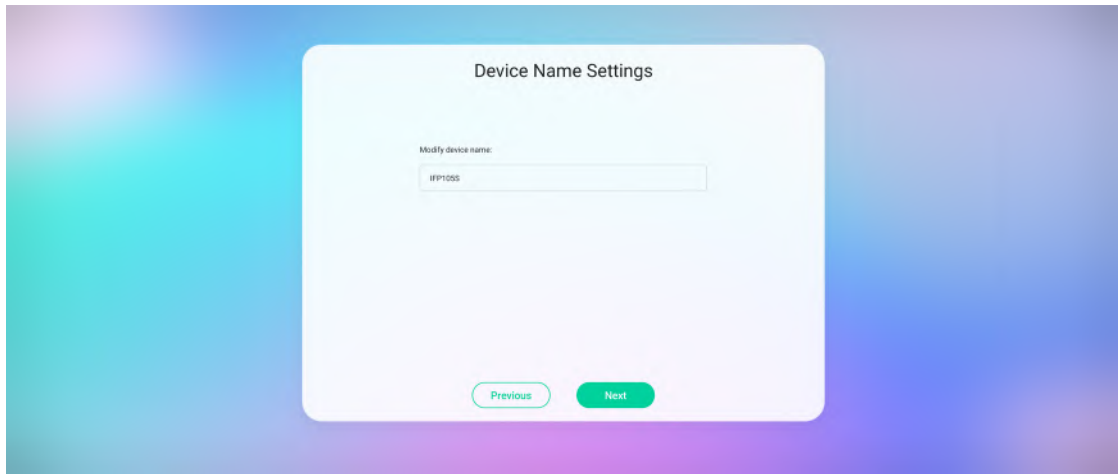

8. Select **Confirm Now** to complete the initial setup.

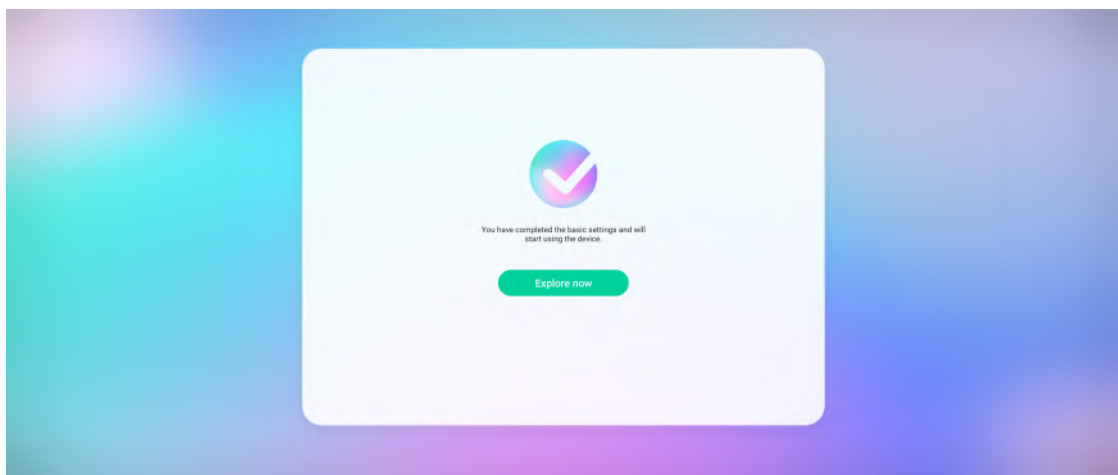

Toolbar

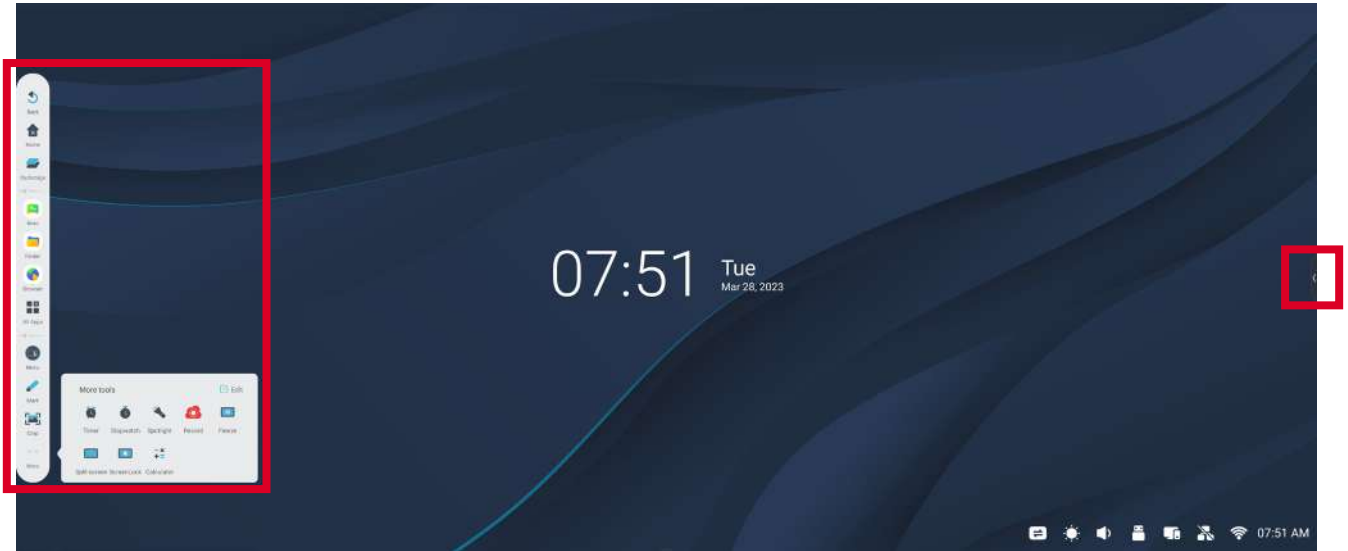

The Toolbar is where your applications and tools can be found. Trigger icons are on the edge of the launcher to provide access.





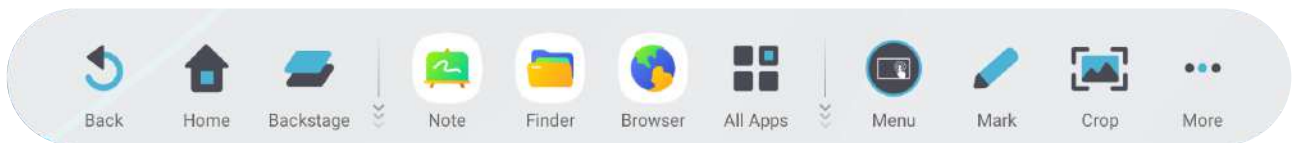





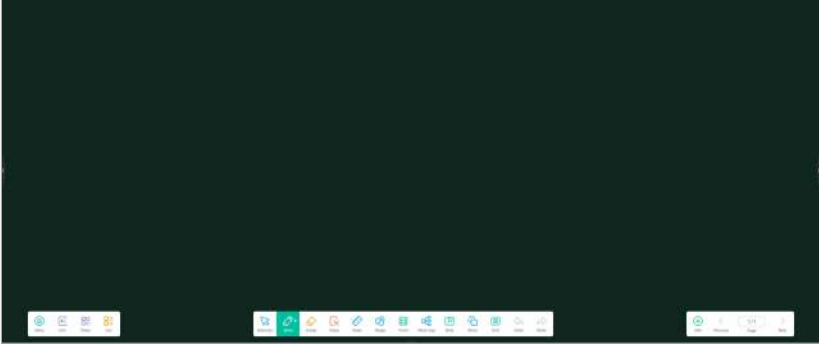



To launch an application or tool:



1. Tap a Toolbar trigger icon.
2. Tap on your desired application or tool icon.







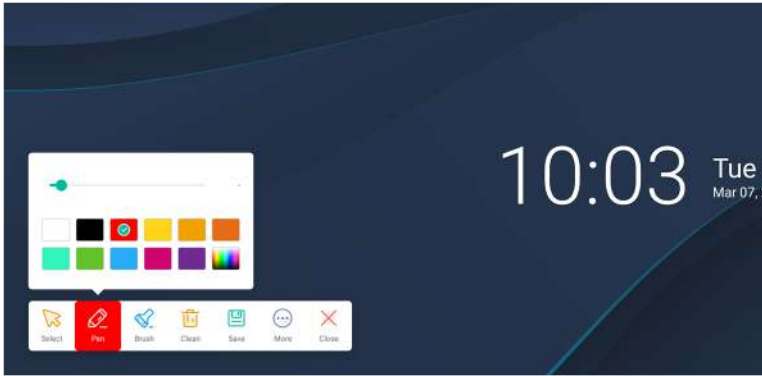



Icon	Description
 Back	Return to the previous operation screen. NOTE: Only for the ViewBoard input source.
 Home	Return to the Home Screen of the ViewBoard input source.
 Backstage	Display all installed applications that are currently open.

Icon	Description
 <p data-bbox="236 450 309 483">Note</p>	<p data-bbox="395 203 874 237">Digital whiteboarding application.</p> 
 <p data-bbox="236 752 309 786">Finder</p>	<p data-bbox="395 689 751 723">Manage files and folders.</p>
 <p data-bbox="236 927 309 960">Browser</p>	<p data-bbox="395 864 927 898">Web browser for surfing the Internet.</p>

Icon	Description
 <p data-bbox="204 1039 338 1077">All Apps</p>	<p data-bbox="395 203 823 237">View all installed applications.</p> <div data-bbox="443 271 1362 533">     <p data-bbox="443 360 612 394">Cloud Drive</p> <p data-bbox="730 360 836 394">Keeper</p> <p data-bbox="959 360 1118 394">OfficeSuite</p> <p data-bbox="1241 360 1347 394">Palette</p>     <p data-bbox="507 501 549 535">PIP</p> <p data-bbox="724 501 842 535">Settings</p> <p data-bbox="995 501 1075 535">vCast</p> <p data-bbox="1225 501 1362 535">Visualizer</p> </div>
	<p data-bbox="395 589 564 622"><u>Cloud Drive</u></p> <p data-bbox="395 633 1182 667">Store and retrieve files from your cloud storage service.</p>
	<p data-bbox="395 734 501 768"><u>Keeper</u></p> <p data-bbox="395 779 1011 813">Clear unnecessary data and unwanted files.</p>
	<p data-bbox="395 869 555 902"><u>OfficeSuite</u></p> <p data-bbox="395 913 1362 992">Create, edit, and view documents, spreadsheets, presentations, and PDFs.</p>
	<p data-bbox="395 1037 501 1070"><u>Palette</u></p> <p data-bbox="395 1081 1043 1115">Select a color and adjust the saturation levels.</p>
	<p data-bbox="395 1171 453 1205"><u>PIP</u></p> <p data-bbox="395 1216 1378 1294">Picture-in-Picture. Split the screen into two parts, a main window and an inset window. User can specify the input source for each screen.</p>
	<p data-bbox="395 1339 517 1373"><u>Settings</u></p> <p data-bbox="395 1384 788 1417">Access the System Settings.</p>
	<p data-bbox="395 1473 485 1507"><u>vCast</u></p> <p data-bbox="395 1518 1347 1641">Working with ViewBoard Cast software, receive vCastSender laptop screens (Windows/Mac/Chrome) and mobile (iOS/Android) users' screens, photos, videos, annotations, and camera(s).</p>
	<p data-bbox="395 1686 533 1720"><u>Visualizer</u></p> <p data-bbox="395 1731 963 1765">Display video from a connected camera.</p>
 <p data-bbox="225 1935 320 1973">Menu</p>	<p data-bbox="395 1877 794 1910">Access the General Settings.</p>

Icon	Description
 Mark	<p>Annotate the overlay of any input source with a pen or brush.</p> 
 Crop	<p>Take a screenshot of the current screen and resize.</p>

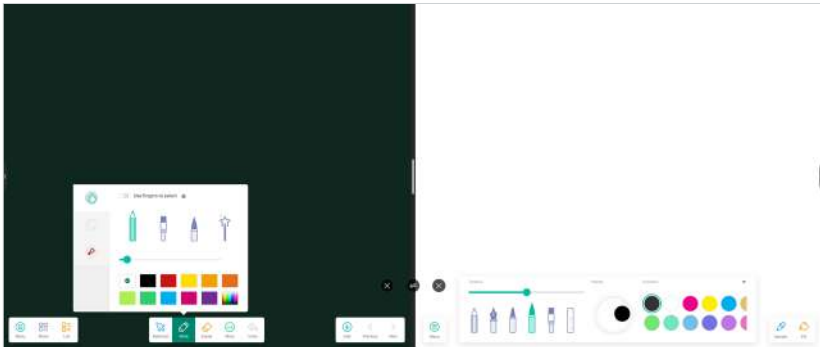
Icon	Description
	<p>View more applications within the toolbar.</p> <div style="display: flex; justify-content: space-around; align-items: center;"> <div style="text-align: center;">  Timer </div> <div style="text-align: center;">  Stopwatch </div> <div style="text-align: center;">  Spotlight </div> <div style="text-align: center;">  Record </div> </div> <div style="display: flex; justify-content: space-around; align-items: center; margin-top: 10px;"> <div style="text-align: center;">  Freeze </div> <div style="text-align: center;">  Split-Screen </div> <div style="text-align: center;">  Screen Lock </div> <div style="text-align: center;">  Calculator </div> </div>
 More	<p><u>Timer</u> A countdown timer with an optional alarm setting. Touch and swipe to adjust the numeric values, then click Start. At any time, the countdown timer can be paused, resumed, or reset.</p>
	<p><u>Stopwatch</u> Tapping Start will initiate the stopwatch. At any time, the stopwatch can be paused, resumed, split, or reset.</p>
	<p><u>Spotlight</u> Highlight the focus content zone. Tap the setting icon to adjust the spotlight size and alpha blending effect.</p>
	<p><u>Record</u> Record, view, and save on-screen content.</p>
	<p><u>Freeze</u> Convert the currently displayed content into a still image; then you can zoom in, zoom out, go back to full screen, and exit.</p>
	<p><u>Split-Screen</u> Split the screen to display two different applications on the display.</p> <div style="text-align: center;">  </div>
	<p><u>Screen Lock</u> Lock the display's screen for added security.</p>
	<p><u>Calculator</u> Use for mathematical calculations.</p>

Control Bar

Frequently used settings and tools can be accessed quickly through the Control Bar.

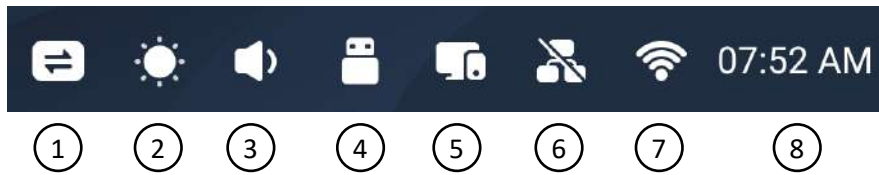

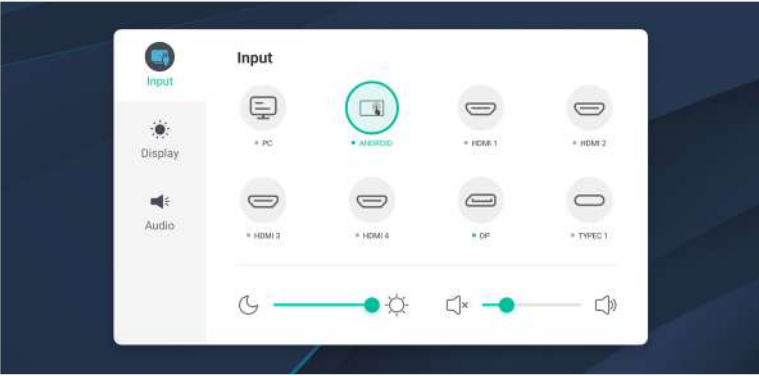
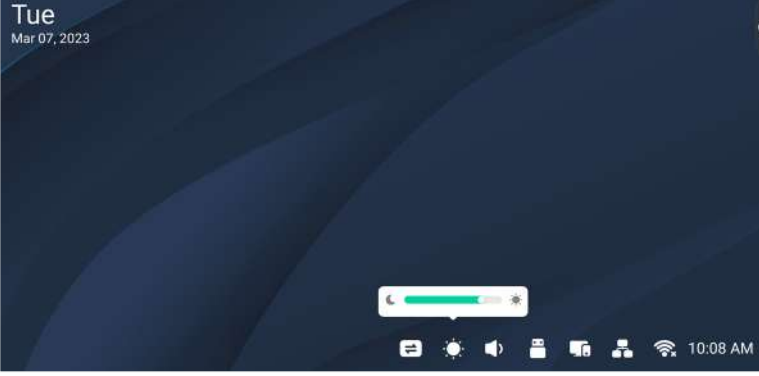
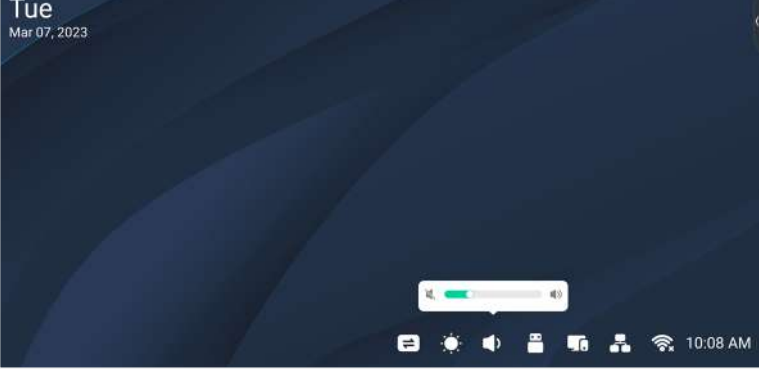
Item	Description
<p>1</p> <p>Input Source</p>	<p>Select the input source.</p> 
<p>2</p> <p>Brightness</p>	<p>Adjust the brightness level of the display.</p> 
<p>3</p> <p>Sound</p>	<p>Adjust the volume level of the display.</p> 

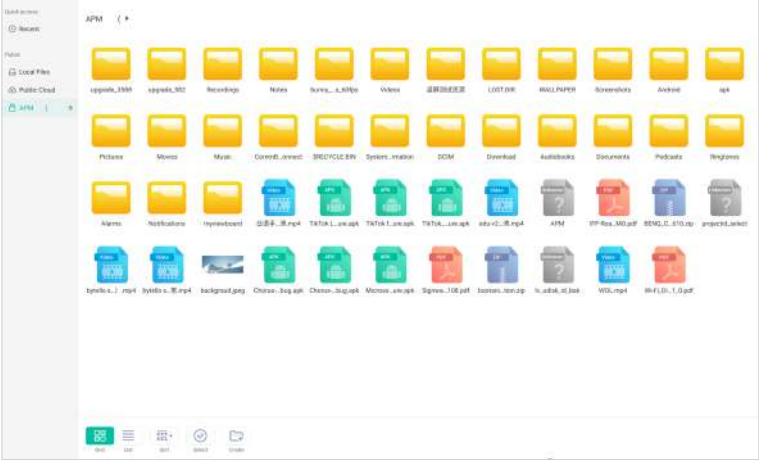
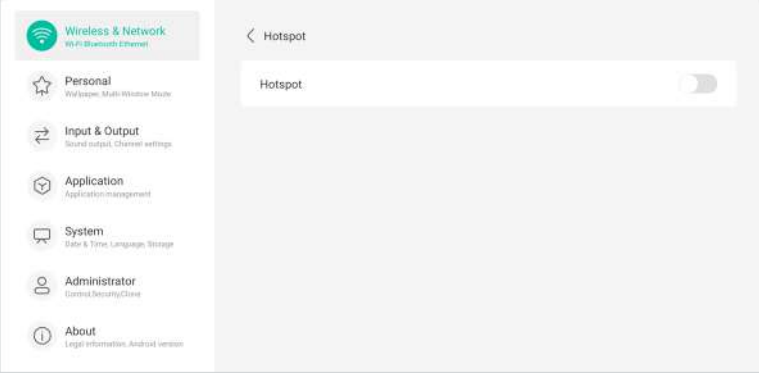
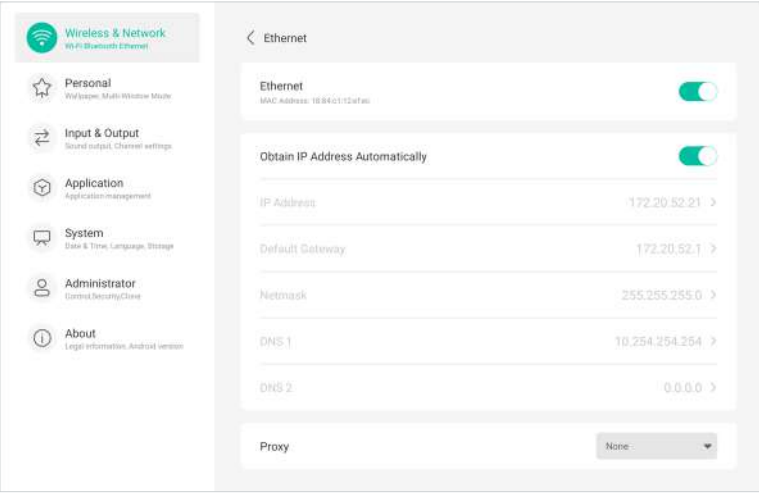
Item	Description	
<p>4</p> <p>USB</p>	<p>If a USB storage device is connected, the USB icon will be visible. Clicking the icon will open the USB storage device's folder.</p> 	
<p>5</p> <p>Hotspot</p>	<p>Shortcut to Wireless & Network hotspot settings. Enable or disable the hotspot function.</p> 	
<p>6</p> <p>Ethernet</p>	<p>Shortcut to Wireless & Network LAN settings. Enable or disable LAN connection.</p> 	

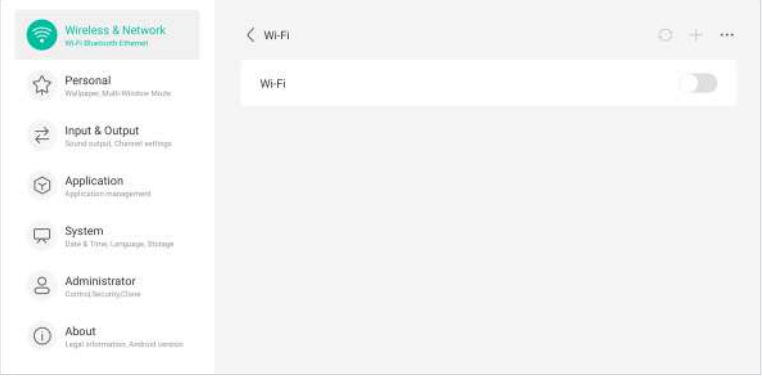
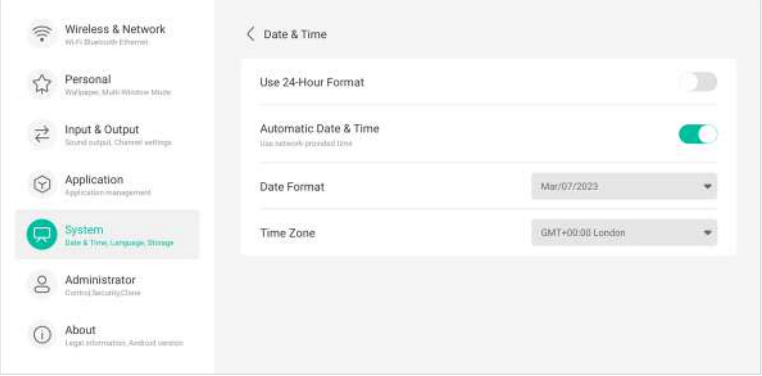
Item	Description
<p>7 Wireless</p>	<p>Shortcut to Wireless & Network Wi-Fi settings. Enable or disable Wi-Fi and connect to a wireless network.</p> 
<p>8 Date & Time</p>	<p>Shortcut to System settings. Set the date and time of the display.</p> 

On-Screen Display (OSD) Menu - General Settings

Access **Input**, **Display**, **Audio** and other general settings through the OSD Menu.

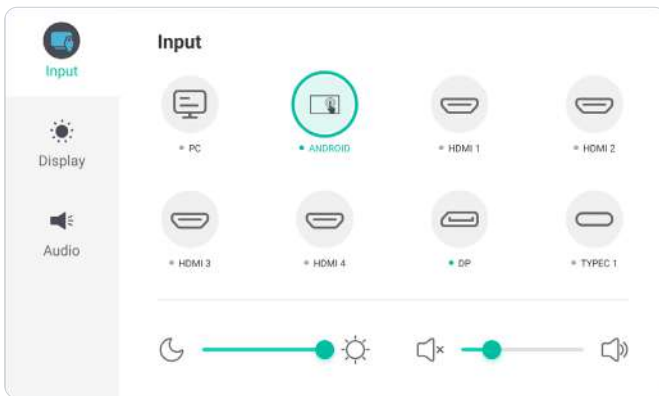

Input Menu

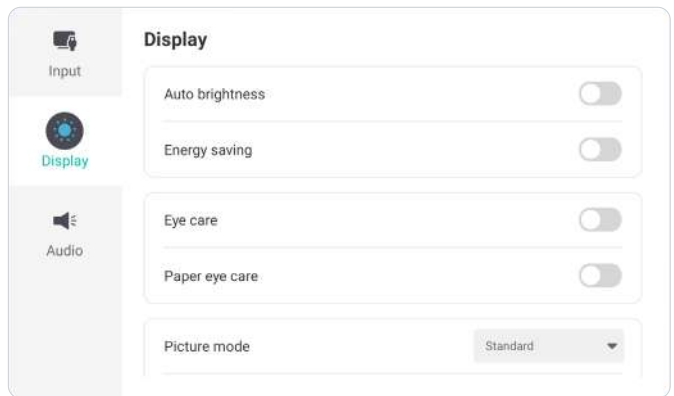

Display Menu

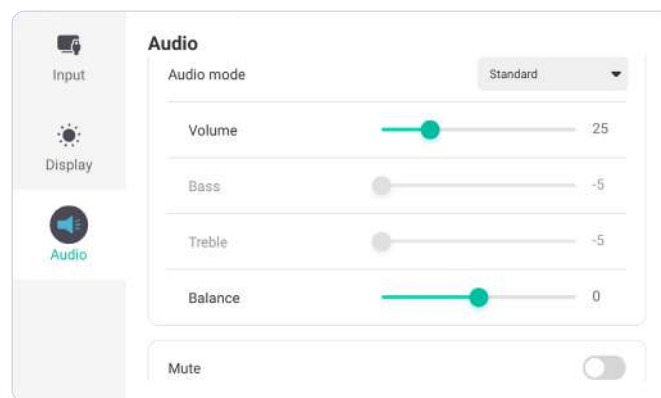

Audio Menu

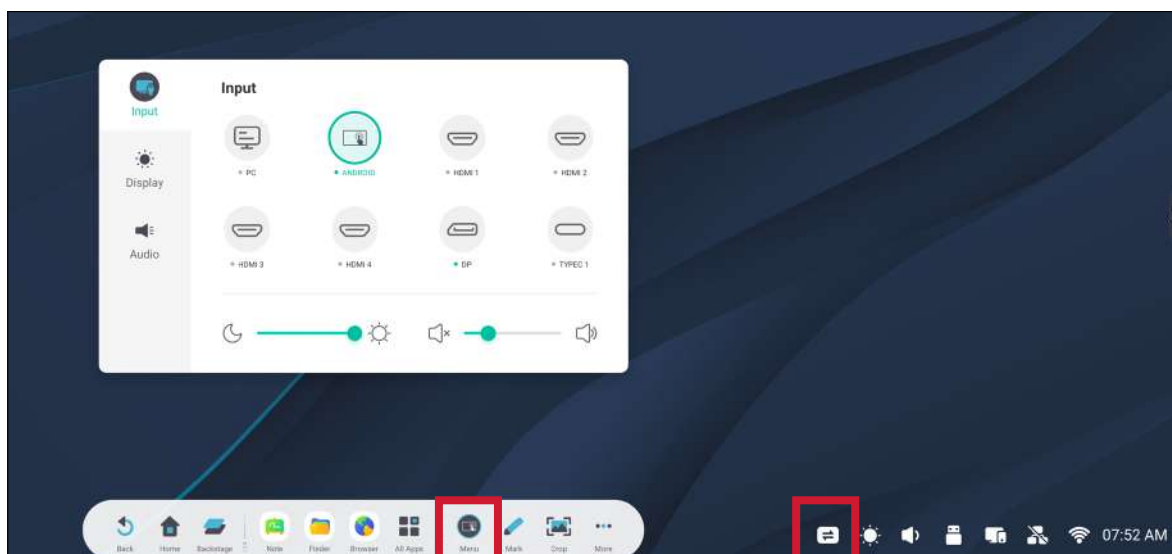

Open the OSD Menu by touching the **Menu** icon () in the Toolbar or the **Input Source** icon () of the Control Bar.

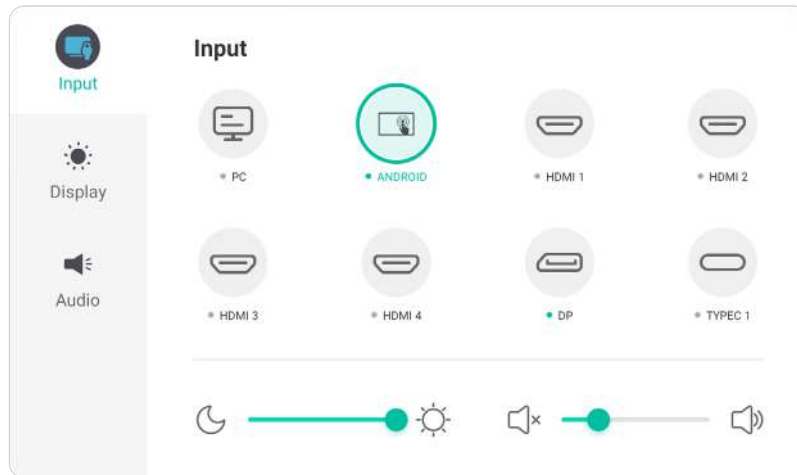

Input Settings





To select an input source:

1. Press **INPUT** on the remote control or touch the **Menu** icon () from the Toolbar or the **Input Source** icon () of the Control Bar to display the **Input Settings** menu.
2. Press **▼/▲/◀/▶** on the remote control to select the input source you want.
NOTE: The PC source will only be visible when a slot-in computer is installed.
3. Press **ENTER** on the remote control, or touch the input source.
4. Press **BACK** on the remote control, or touch a blank area outside of the menu to exit.



To adjust the brightness:



1. Press **INPUT** on the remote control or touch the **Menu** icon () from the Toolbar or the **Input Source** icon () of the Control Bar to display the **Input Settings** menu.
2. Touch and drag the brightness slider directly to adjust the backlight value.
3. Press **BACK** on the remote control, or touch a blank area outside of the menu to exit.

To adjust the volume:



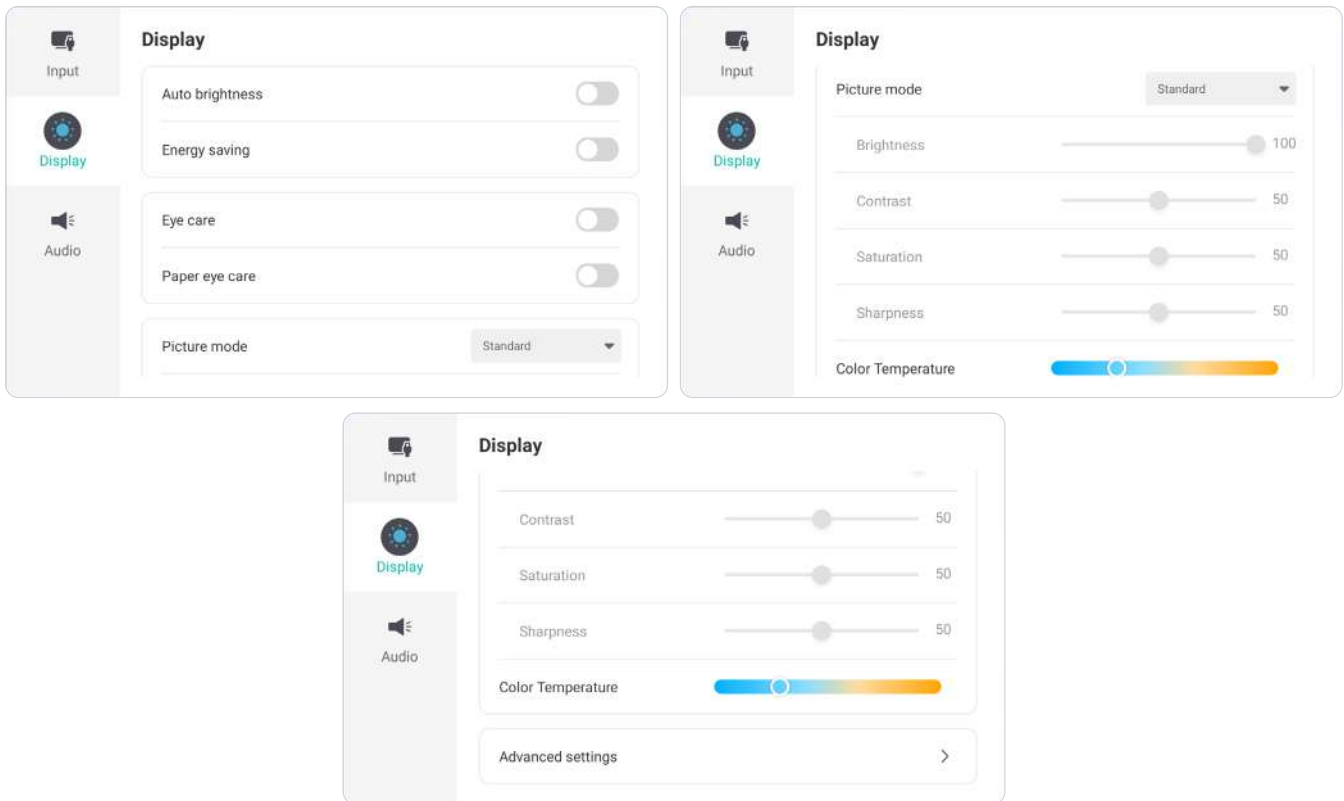

1. Press **INPUT** on the remote control or touch the **Menu** icon () from the Toolbar or the **Input Source** icon () of the Control Bar to display the **Input Settings** menu.
2. Touch and drag the volume slider directly to adjust the value, or press **VOL +/VOL -** on the remote control to adjust. Additionally, pressing **Mute** () on the remote control will mute/unmute the volume.
3. Press **BACK** on the remote control, or touch a blank area outside of the menu to exit.

Display Settings



To adjust the display settings:

1. Press **INPUT** on the remote control or touch the **Menu** icon () from the Toolbar or the **Input Source** icon () of the Control Bar to display the **Input Settings** menu. Then select the **Display** tab.
2. Press **▼/▲/◀/▶** on the remote control to select the menu option you want.
3. Press **ENTER** on the remote control to confirm or press **◀/▶** to adjust the menu option. Additionally, touch/adjust the menu option directly.
4. Press **BACK** on the remote control, or touch a blank area outside of the menu to exit.

Display Settings - Menu Options



Item	Description										
Auto Brightness	Automatic brightness adjustment. Adjusts maximum brightness according to ambient light levels.										
Energy Saving	Enable to reduce power consumption.										
Eye Care	Adjusts the filter that blocks high-energy blue light for a more comfortable viewing experience.										
Paper Eye Care	When “Low Blue Light” is enabled, adjust the Transparency to lower the brightness and warm the color temperature.										
Picture Mode	Select a predefined picture setting.										
	<table border="1"> <thead> <tr> <th data-bbox="480 698 692 743">Mode</th> <th data-bbox="692 698 1401 743">Description</th> </tr> </thead> <tbody> <tr> <td data-bbox="480 743 692 797">Standard</td> <td data-bbox="692 743 1401 797">Default picture mode.</td> </tr> <tr> <td data-bbox="480 797 692 922">Bright</td> <td data-bbox="692 797 1401 922">Maximizes the brightness of the display. This mode is suitable for environments where extra-high brightness is required (e.g., well-lit rooms).</td> </tr> <tr> <td data-bbox="480 922 692 976">Soft</td> <td data-bbox="692 922 1401 976">A high brightness level with lower contrast level.</td> </tr> <tr> <td data-bbox="480 976 692 1030">Custom</td> <td data-bbox="692 976 1401 1030">Customize the picture settings.</td> </tr> </tbody> </table>	Mode	Description	Standard	Default picture mode.	Bright	Maximizes the brightness of the display. This mode is suitable for environments where extra-high brightness is required (e.g., well-lit rooms).	Soft	A high brightness level with lower contrast level.	Custom	Customize the picture settings.
	Mode	Description									
	Standard	Default picture mode.									
	Bright	Maximizes the brightness of the display. This mode is suitable for environments where extra-high brightness is required (e.g., well-lit rooms).									
Soft	A high brightness level with lower contrast level.										
Custom	Customize the picture settings.										
Standard	Default picture mode.										
Bright	Maximizes the brightness of the display. This mode is suitable for environments where extra-high brightness is required (e.g., well-lit rooms).										
Soft	A high brightness level with lower contrast level.										
Custom	Customize the picture settings.										
Brightness	Adjusts background black levels of the screen image. The higher the value, the brighter the image. Lower values will result in a darker image.										
Contrast	Adjusts the difference between the image background (black level) and the foreground (white level). Use this to set the peak white level after you have previously adjusted the Brightness setting to suit your selected input and viewing environment.										
Saturation	The amount of color in a picture. Lower settings produce less saturated colors; in fact, a setting of “0” removes that color from the image entirely. If the saturation is too high though, that color will be overpowering and unrealistic.										
Sharpness	A high value results in a sharper picture; a low value softens the picture.										
Color Temperature	Adjust the color temperature value.										

Item	Description														
Advanced Settings	<p><u>Color Space</u> Choose the color space to use for color output.</p> <table border="1" data-bbox="480 291 1401 824"> <thead> <tr> <th data-bbox="480 291 692 342">Mode</th> <th data-bbox="692 291 1401 342">Description</th> </tr> </thead> <tbody> <tr> <td data-bbox="480 342 692 394">Standard</td> <td data-bbox="692 342 1401 394">Default color space standard.</td> </tr> <tr> <td data-bbox="480 394 692 479">sRGB</td> <td data-bbox="692 394 1401 479">Precise color gamut and gamma of the sRGB standard.</td> </tr> <tr> <td data-bbox="480 479 692 564">AdobeRGB</td> <td data-bbox="692 479 1401 564">Precise color gamut and gamma of the Adobe RGB standard.</td> </tr> <tr> <td data-bbox="480 564 692 649">Display-P3</td> <td data-bbox="692 564 1401 649">Precise color gamut and gamma of the Display-P3 standard.</td> </tr> <tr> <td data-bbox="480 649 692 734">DCI-P3</td> <td data-bbox="692 649 1401 734">Precise color gamut and gamma of the DCI-P3 standard.</td> </tr> <tr> <td data-bbox="480 734 692 824">BT2020</td> <td data-bbox="692 734 1401 824">Precise color gamut and gamma of the BT2020 standard.</td> </tr> </tbody> </table>	Mode	Description	Standard	Default color space standard.	sRGB	Precise color gamut and gamma of the sRGB standard.	AdobeRGB	Precise color gamut and gamma of the Adobe RGB standard.	Display-P3	Precise color gamut and gamma of the Display-P3 standard.	DCI-P3	Precise color gamut and gamma of the DCI-P3 standard.	BT2020	Precise color gamut and gamma of the BT2020 standard.
	Mode	Description													
	Standard	Default color space standard.													
	sRGB	Precise color gamut and gamma of the sRGB standard.													
	AdobeRGB	Precise color gamut and gamma of the Adobe RGB standard.													
	Display-P3	Precise color gamut and gamma of the Display-P3 standard.													
	DCI-P3	Precise color gamut and gamma of the DCI-P3 standard.													
	BT2020	Precise color gamut and gamma of the BT2020 standard.													
	<p><u>HDMI Range</u> Select a suitable color range according to the color range setting of the connected output device.</p> <table border="1" data-bbox="480 992 1401 1193"> <thead> <tr> <th data-bbox="480 992 692 1043">Mode</th> <th data-bbox="692 992 1401 1043">Description</th> </tr> </thead> <tbody> <tr> <td data-bbox="480 1043 692 1095">Auto</td> <td data-bbox="692 1043 1401 1095">Detect the range of the input signal automatically.</td> </tr> <tr> <td data-bbox="480 1095 692 1146">Full</td> <td data-bbox="692 1095 1401 1146">Sets the color range from 0~255</td> </tr> <tr> <td data-bbox="480 1146 692 1193">Limited</td> <td data-bbox="692 1146 1401 1193">Sets the color range from 16~235</td> </tr> </tbody> </table>	Mode	Description	Auto	Detect the range of the input signal automatically.	Full	Sets the color range from 0~255	Limited	Sets the color range from 16~235						
	Mode	Description													
Auto	Detect the range of the input signal automatically.														
Full	Sets the color range from 0~255														
Limited	Sets the color range from 16~235														
<p><u>Pixel Shift</u> Reduce the possibility of screen burn-in. This setting allows the user to program the time between movements of the picture in minutes.</p>															
<p><u>AI PQ</u> Automatically set the optimal resolution of the display.</p>															
<p><u>Dynamic Backlight (DCR)</u> Automatically detects the image signal and intelligently controls the backlight brightness and color to improve on the ability to make the black blacker in a dark scene, and make the white whiter in a bright environment.</p>															

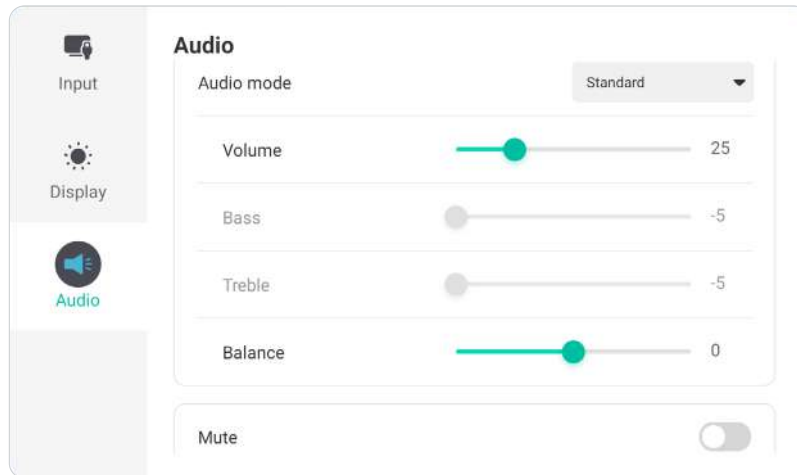
Audio Settings



To adjust the display settings:

1. Press **INPUT** on the remote control or touch the **Menu** icon () from the Toolbar or the **Input Source** icon () of the Control Bar to display the **Input Settings** menu. Then select the **Audio** tab.
2. Press **▼/▲/◀/▶** on the remote control to select the menu option you want.
3. Press **ENTER** on the remote control to confirm or press **◀/▶** to adjust the menu option. Additionally, touch/adjust the menu option directly.
4. Press **BACK** on the remote control, or touch a blank area outside of the menu to exit.

Audio Settings - Menu Options

Item	Description										
Audio Mode	Select a predefined audio setting.										
	<table border="1"> <thead> <tr> <th data-bbox="480 309 691 360">Mode</th> <th data-bbox="691 309 1401 360">Description</th> </tr> </thead> <tbody> <tr> <td data-bbox="480 360 691 412">Standard</td> <td data-bbox="691 360 1401 412">Default audio mode.</td> </tr> <tr> <td data-bbox="480 412 691 463">Meeting</td> <td data-bbox="691 412 1401 463">Ideal for meetings. Higher bass, lower treble levels.</td> </tr> <tr> <td data-bbox="480 463 691 515">Class</td> <td data-bbox="691 463 1401 515">Ideal for the classroom. Low bass and treble levels.</td> </tr> <tr> <td data-bbox="480 515 691 566">Custom</td> <td data-bbox="691 515 1401 566">Customize the audio settings.</td> </tr> </tbody> </table>	Mode	Description	Standard	Default audio mode.	Meeting	Ideal for meetings. Higher bass, lower treble levels.	Class	Ideal for the classroom. Low bass and treble levels.	Custom	Customize the audio settings.
	Mode	Description									
	Standard	Default audio mode.									
	Meeting	Ideal for meetings. Higher bass, lower treble levels.									
Class	Ideal for the classroom. Low bass and treble levels.										
Custom	Customize the audio settings.										
Volume	Increase or decrease the display's volume level.										
Bass	Increase or decrease the bass level (lower-pitched sounds).										
Treble	Increase or decrease the treble level (higher-pitched sounds).										
Balance	Adjust the left/right speaker balance.										
Mute	Toggle mute ON or OFF.										

Low Blue Light Filter and Eye Health

The Blue Light Filter blocks high-energy blue light for a more comfortable viewing experience.

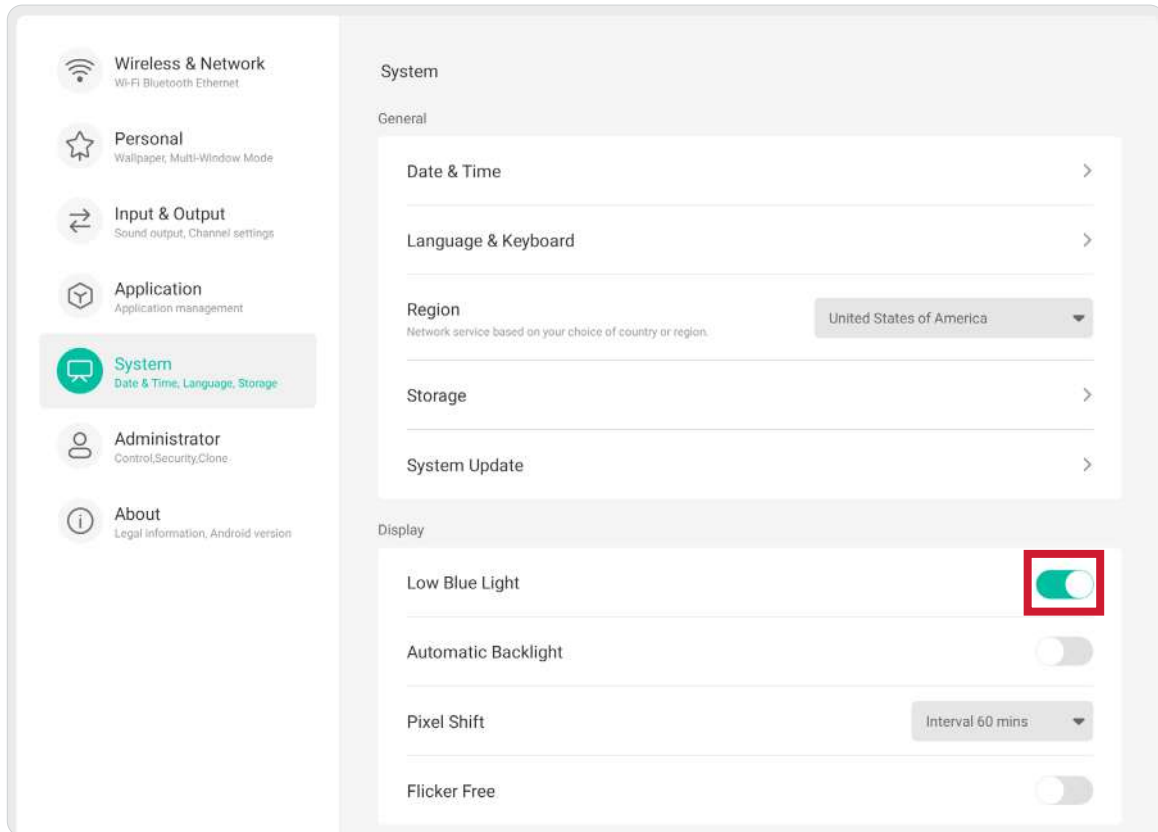

Calculating Breaks

When viewing screens for extended periods, it is recommended to take periodic breaks from viewing. Short breaks of at least 10 minutes are recommended after one (1) hour of continuous viewing.

Taking shorter, more frequent breaks are generally more beneficial than longer, less frequent breaks.

Focus Fatigue (20-20-20 Rule)

To reduce the risk of eye fatigue by constantly looking at the screen, look away from the screen at least every 20 minutes and gaze at a distant object (at least 20 feet away) for at least 20 seconds.

Looking at Distant Objects

While taking breaks, users can further reduce eye strain and dryness by focusing on objects that are further away from them for 10-15 seconds, then gaze at something up close for 10-15 seconds. Repeat this up to 10 times. This exercise reduces the risk of your eyes' focusing ability to "lock up" after prolonged computer work.

Eye and Neck Exercises

Eye Exercises

Eye exercises can help minimize eye strain. Slowly roll your eyes to the left, right, up, and down. Repeat as many times as needed.

Exercises for the eyes

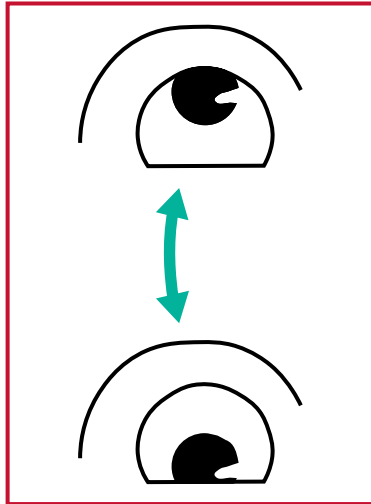

(1) Keep the body and the head upright. Move the eyes up to look at the ceiling, then turn down to look at the floor.

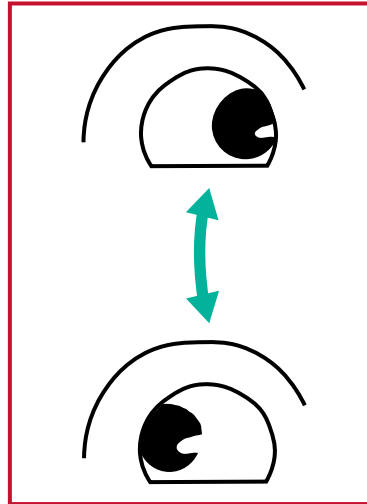

(2) Move the eyes left and right slowly to look at objects on the two sides.

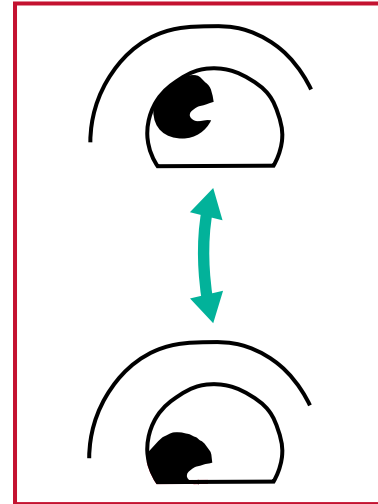

(3) Move the eyes to look at objects at the right upper direction and then right lower direction. Repeat for the left upper and left lower directions.

Neck Exercises

Neck exercises can also help minimize eye strain. Relax your arms and let them hang at your sides, bend forward slightly to stretch the neck, turn your head to the right and to the left. Repeat as many times as needed.

Settings - ViewBoard Input Source

When the display is in the ViewBoard input source, press **MENU** on the remote control or touch the **Settings** icon () in the Toolbar to open the **Settings** menu.

Wireless & Network

Check current network connection status and set up and manage **Wi-Fi**, **Ethernet**, **Hotspot**, **Bluetooth**, and **VPN**.

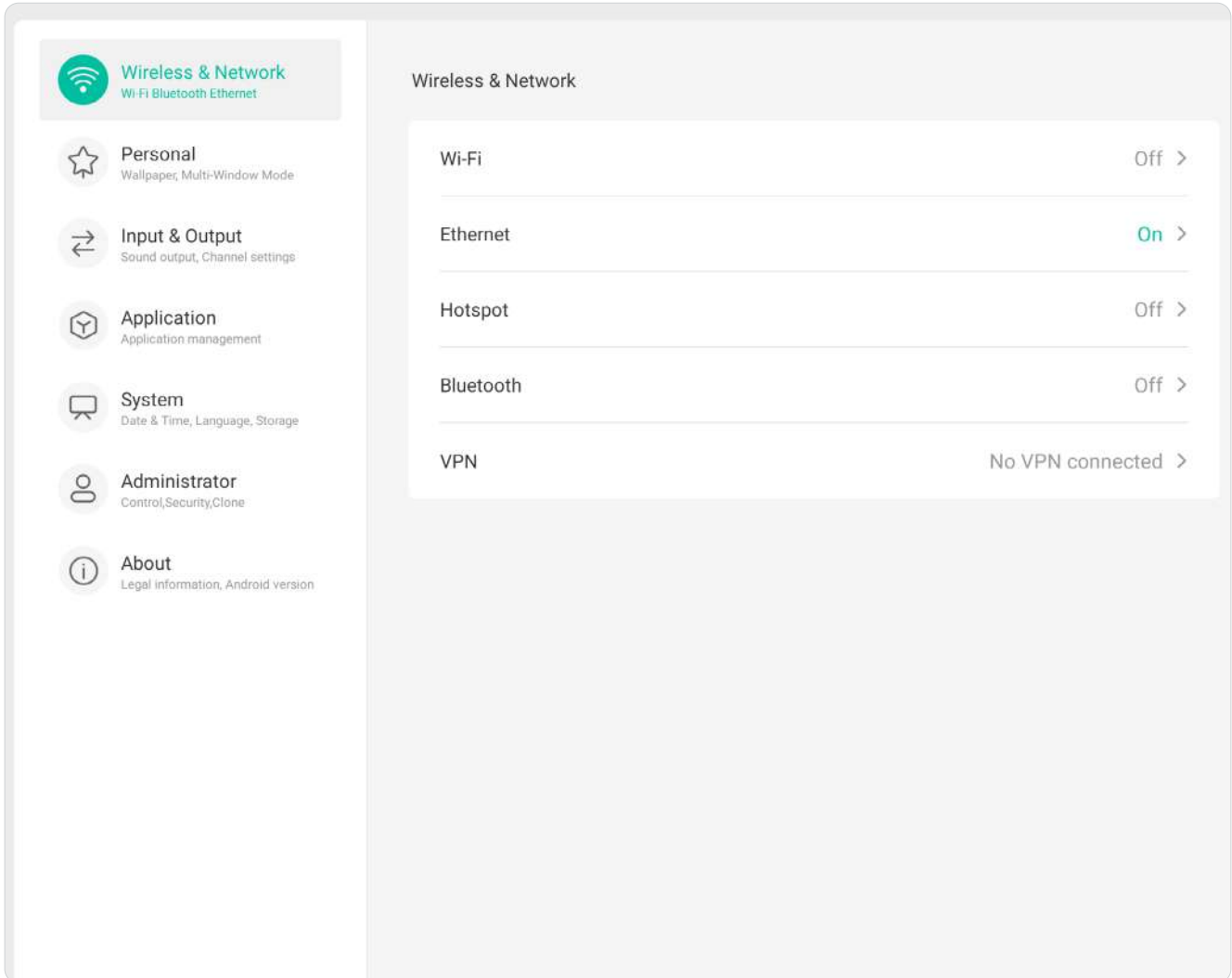

NOTE:

- Ethernet will disable automatically when Wi-Fi is enabled. Wi-Fi will disable automatically when Ethernet is enabled. Wi-Fi will disable when Wireless hotspot is enabled.
- The device cannot connect to the Internet when Wireless Hotspot is enabled.

Wi-Fi

Setup and manage wireless access points.

- Touch the toggle to turn **Wi-Fi ON** or **OFF**.

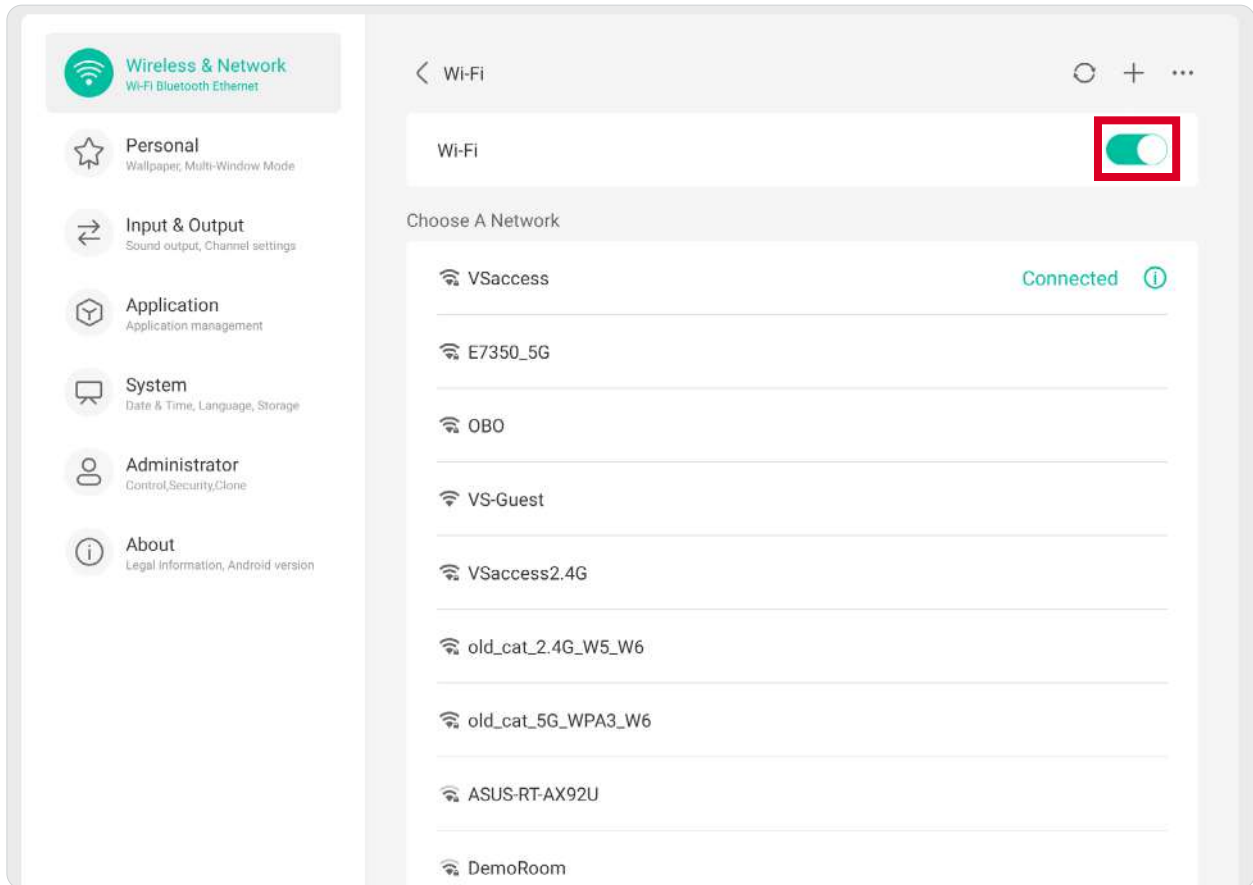

- Once **ON**, you can: **Add a Network**, view **Saved Networks**, **Refresh** the network list, or view **Advanced** settings.

Ethernet

Set the local network and proxy.

- Touch the toggle to turn **Ethernet ON** or OFF.

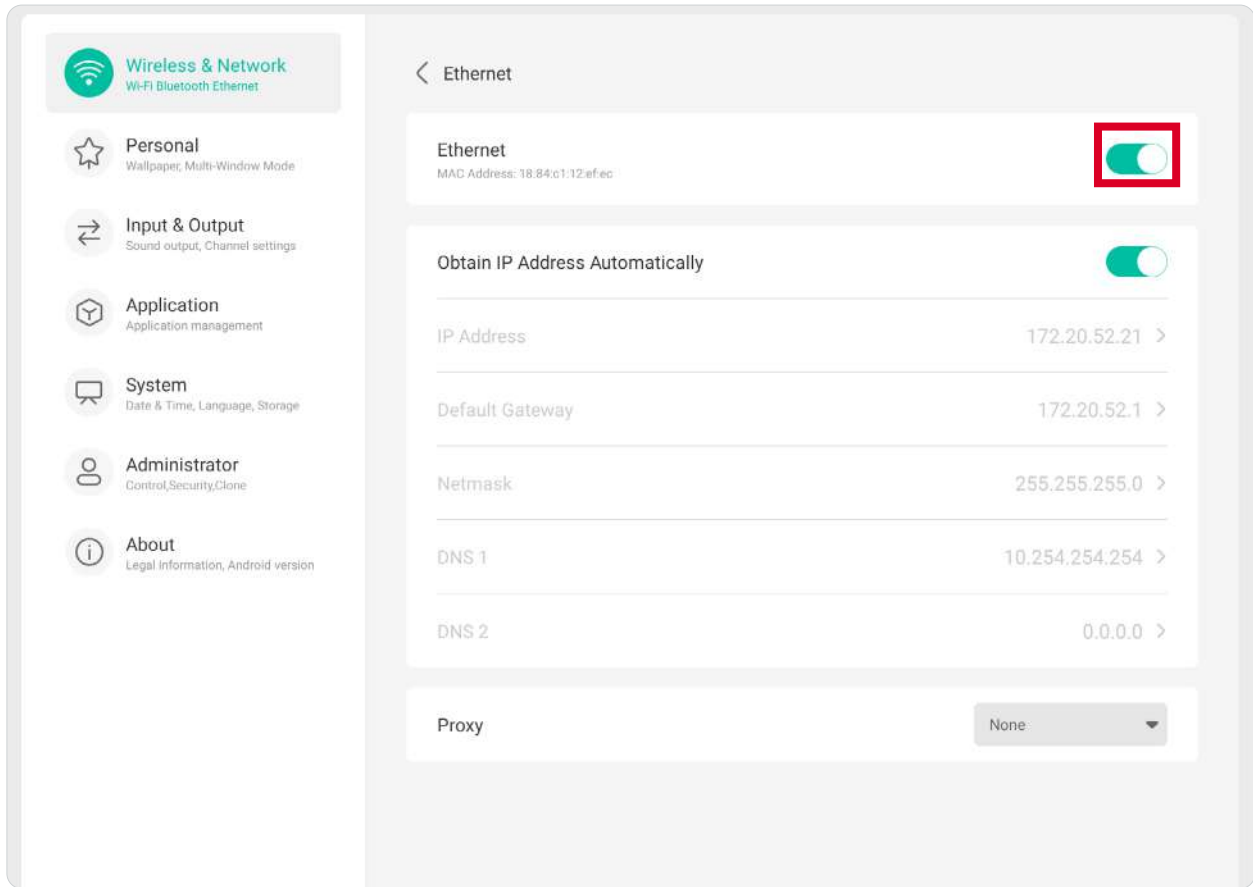

- You can choose to **Obtain an IP Address Automatically** and adjust the **Proxy** settings as well.

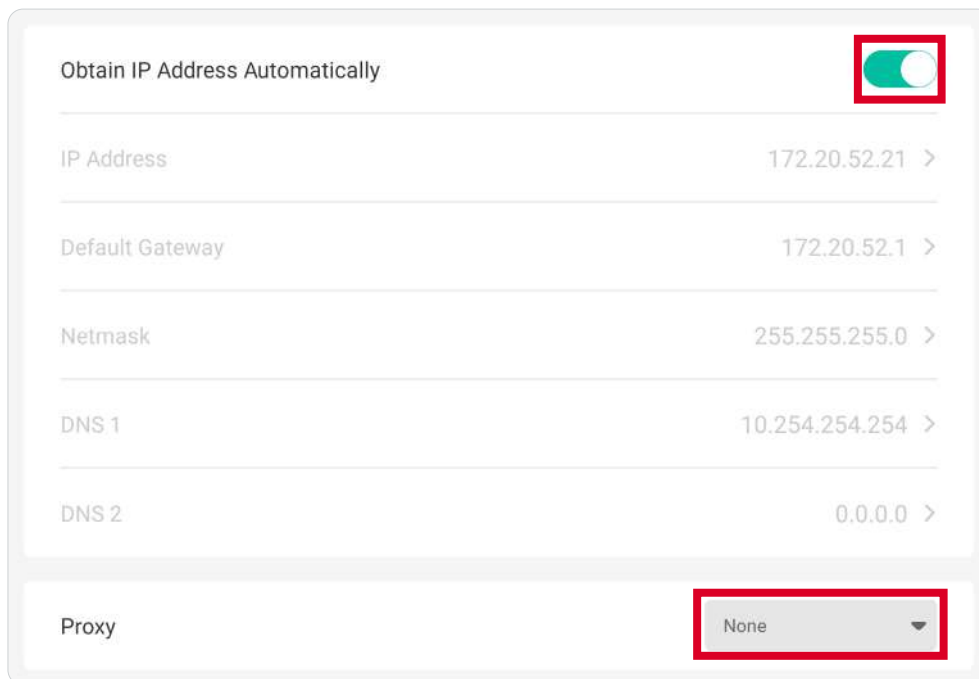

Hotspot

Set and share your internet connection with other devices.

- Touch the toggle to turn **Hotspot** ON or OFF.

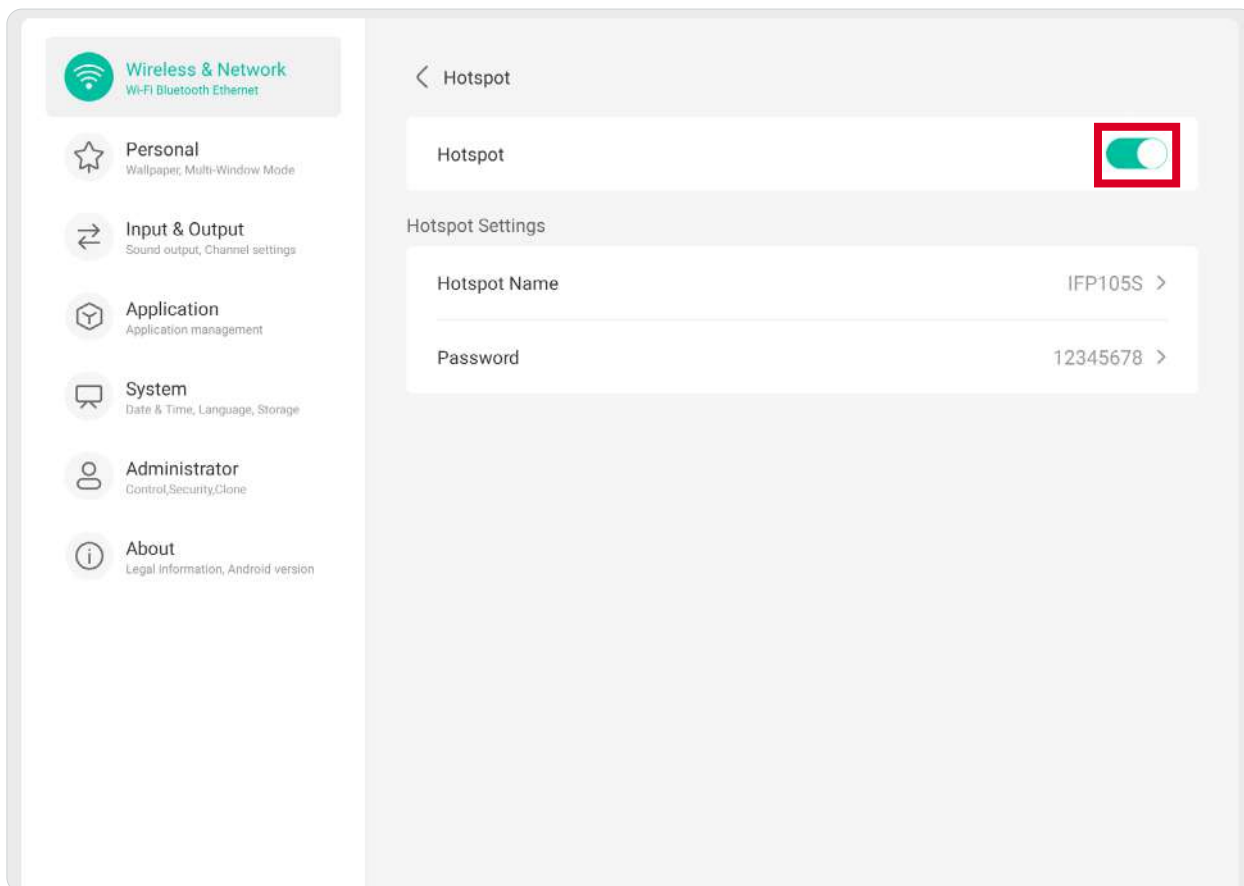

Bluetooth

Manage Bluetooth connections, set the device name and discoverability.

- Touch the toggle to turn **Bluetooth** ON or OFF. Once ON, users can select a listed device to pair and connect to, rename their device, remove a device, or receive files.

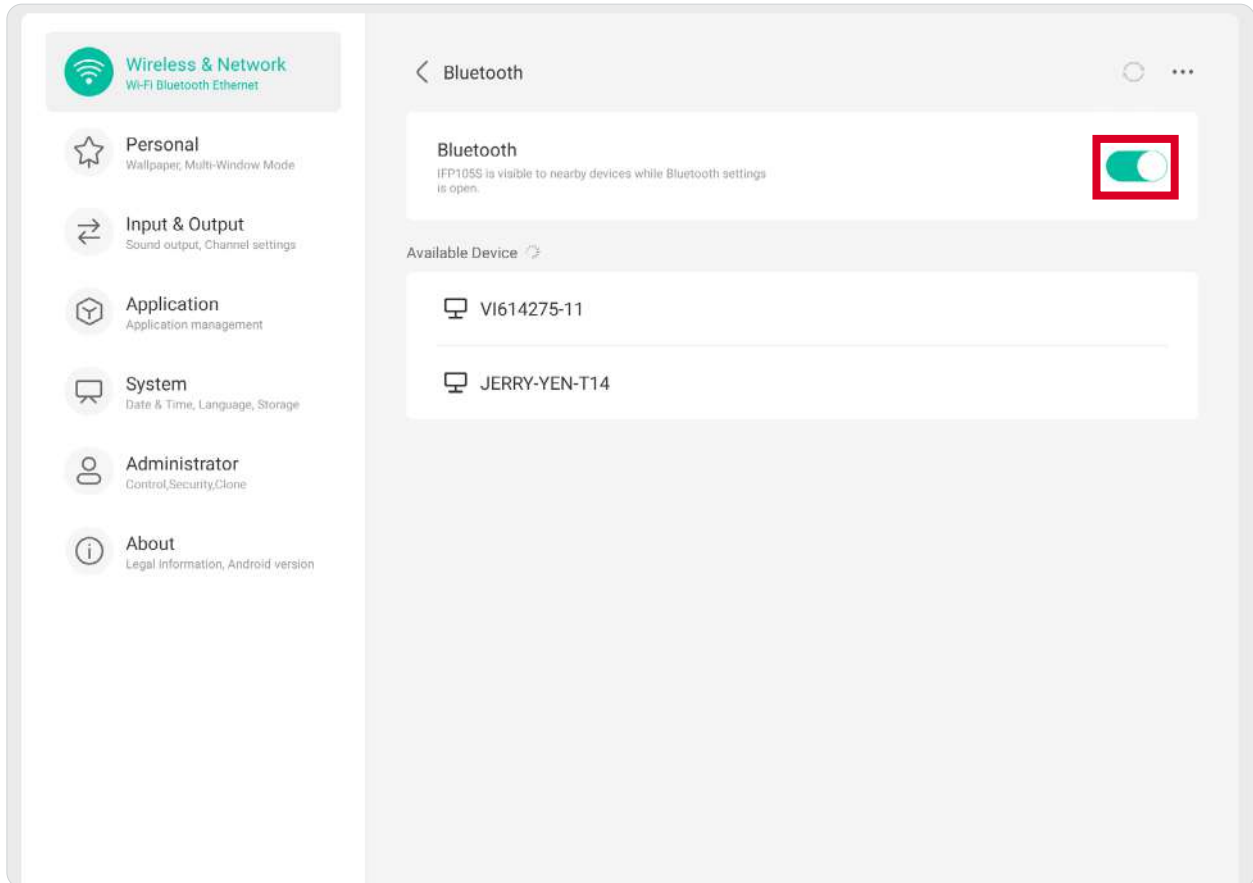

VPN

Setup and manage Virtual Private Networks.

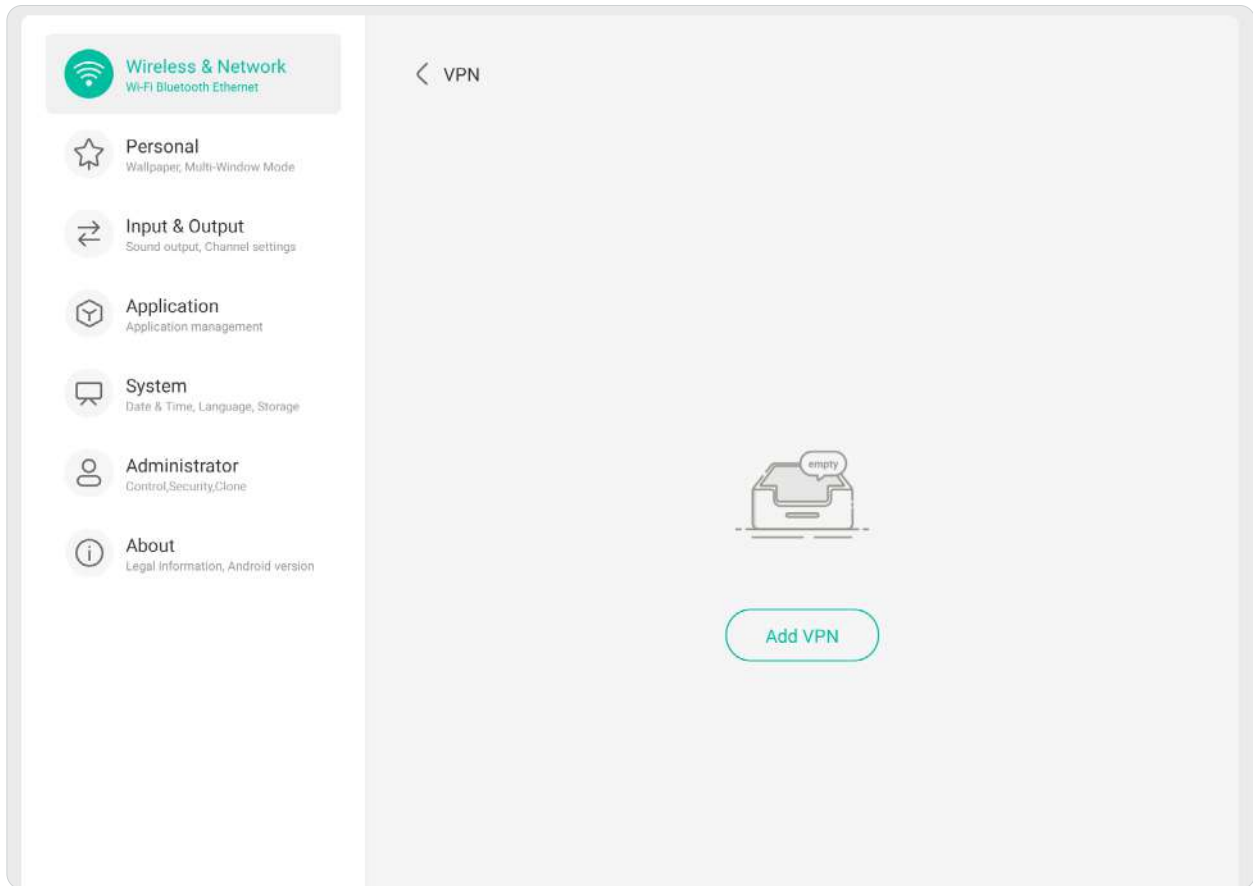

To create a VPN profile:

1. Go to: **Settings > Wireless & Network > VPN** and choose **Add VPN**.
2. Key in the **Name**.
3. Select the **VPN Type**.
4. Choose to enable/disable **PPP encryption (MPPE)** and/or show **Advanced options**.

Personal

Adjust the **Wallpaper**, **Screen Saver**, **Swipe**, **Multi-Window**, and **Window Control Bar** settings.

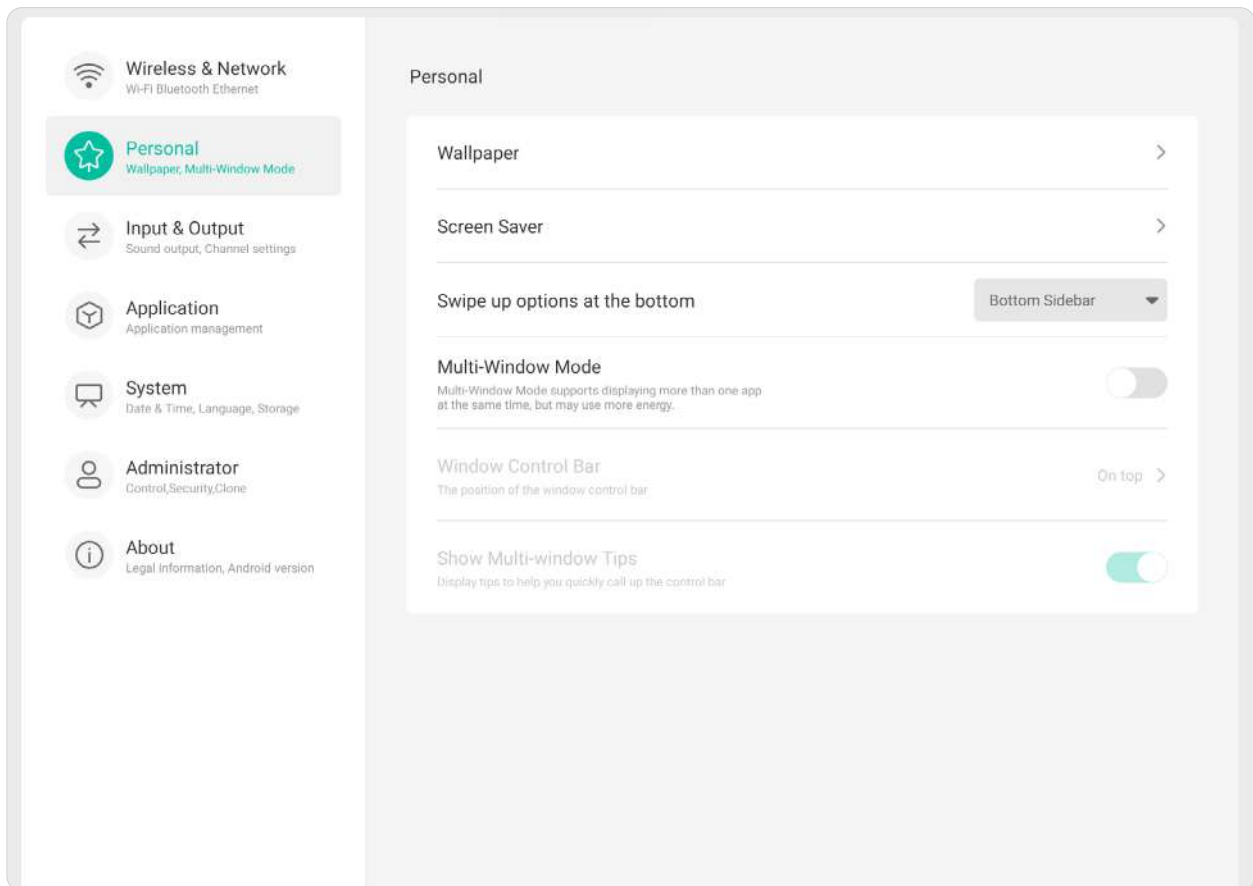

Wallpaper

Users can change their wallpaper with default images (both still and dynamic), or use their own by tapping **My Photo** and selecting the image file.

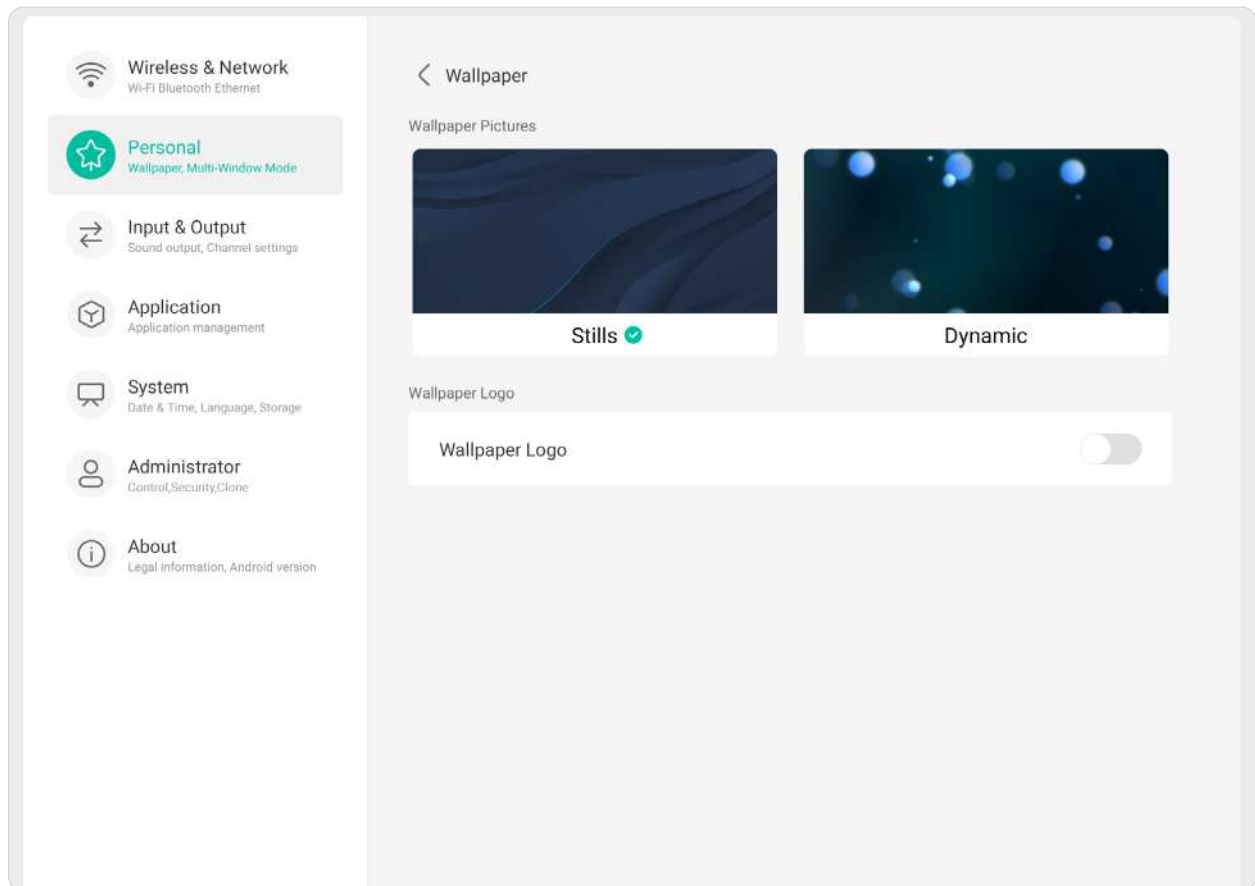

Screen Saver

Set and adjust screen saver settings.

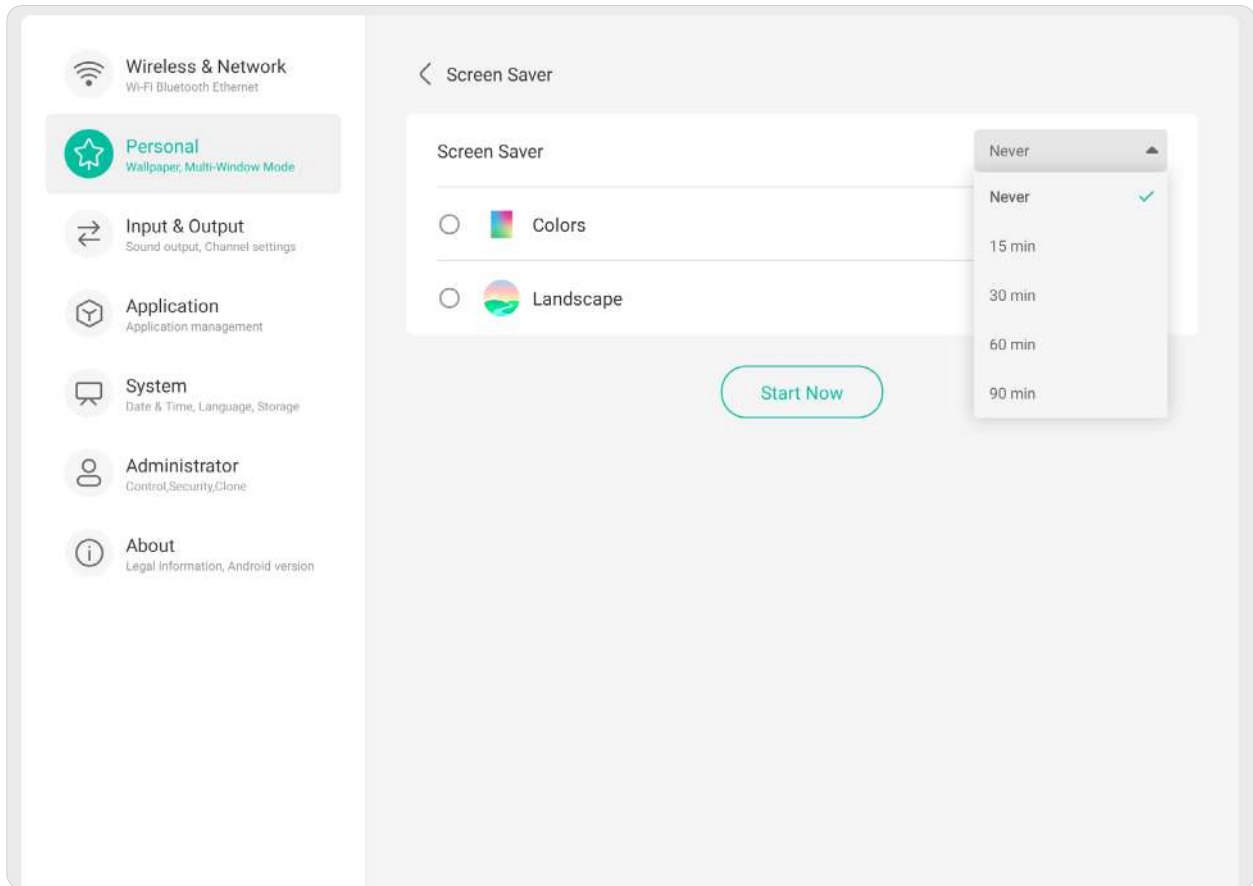

Swipe Up Options at the Bottom

Choose from **Bottom Sidebar** and **Source Menu**.

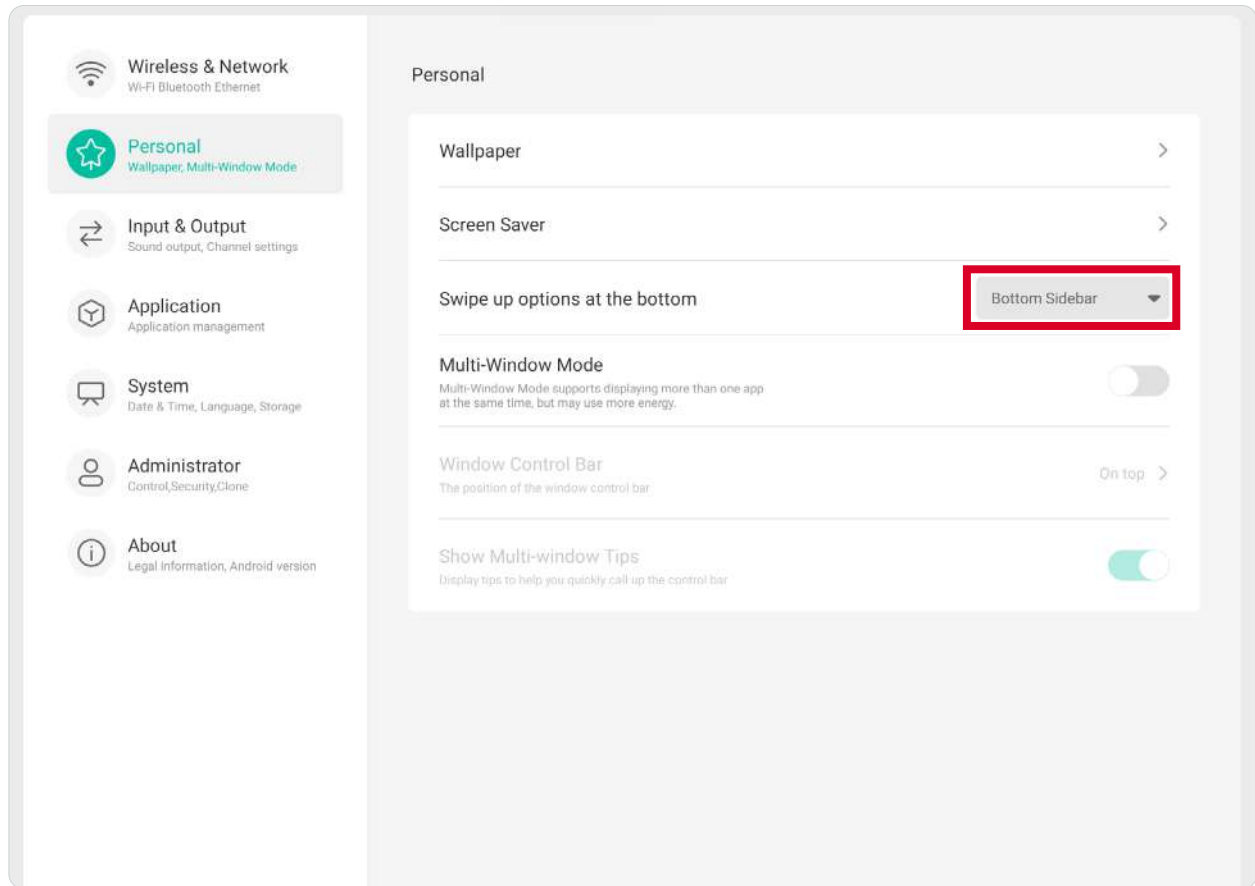

Multi-Window Mode

Display more than one application at the same time on screen when turned ON.

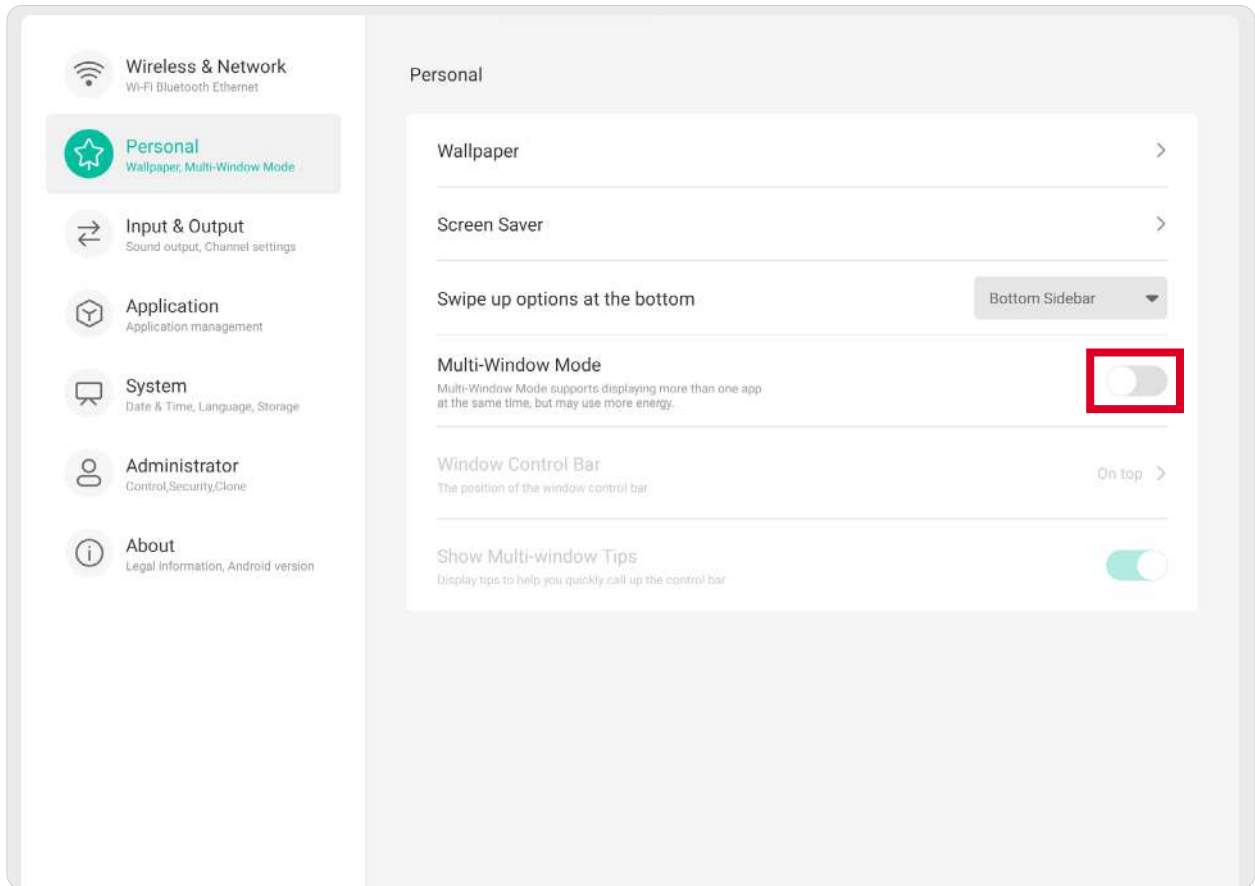

Window Control Bar

Choose from **On Top**, **Left Side**, and **Right Side**.

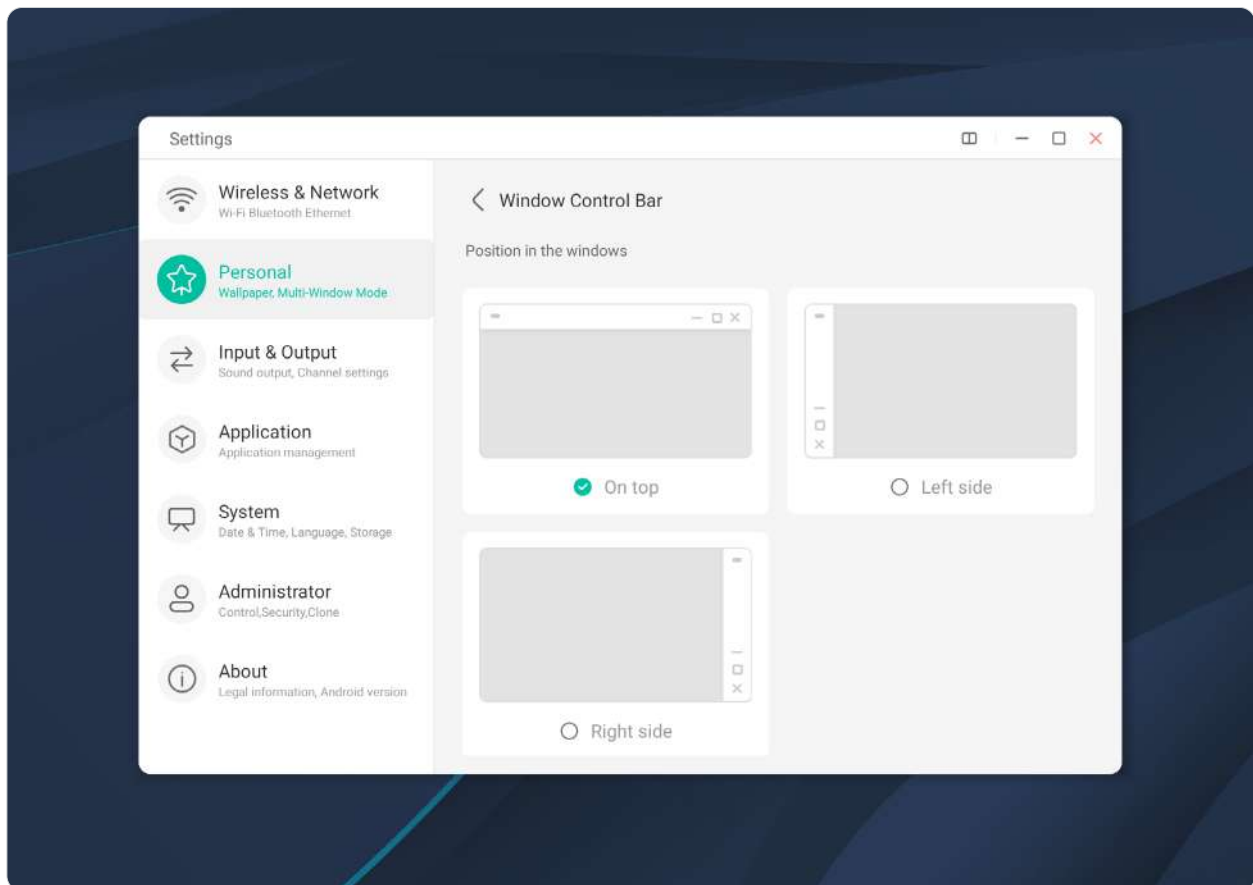

Input & Output

Adjust the **Sound**, **Input**, and **External Source Display** settings.

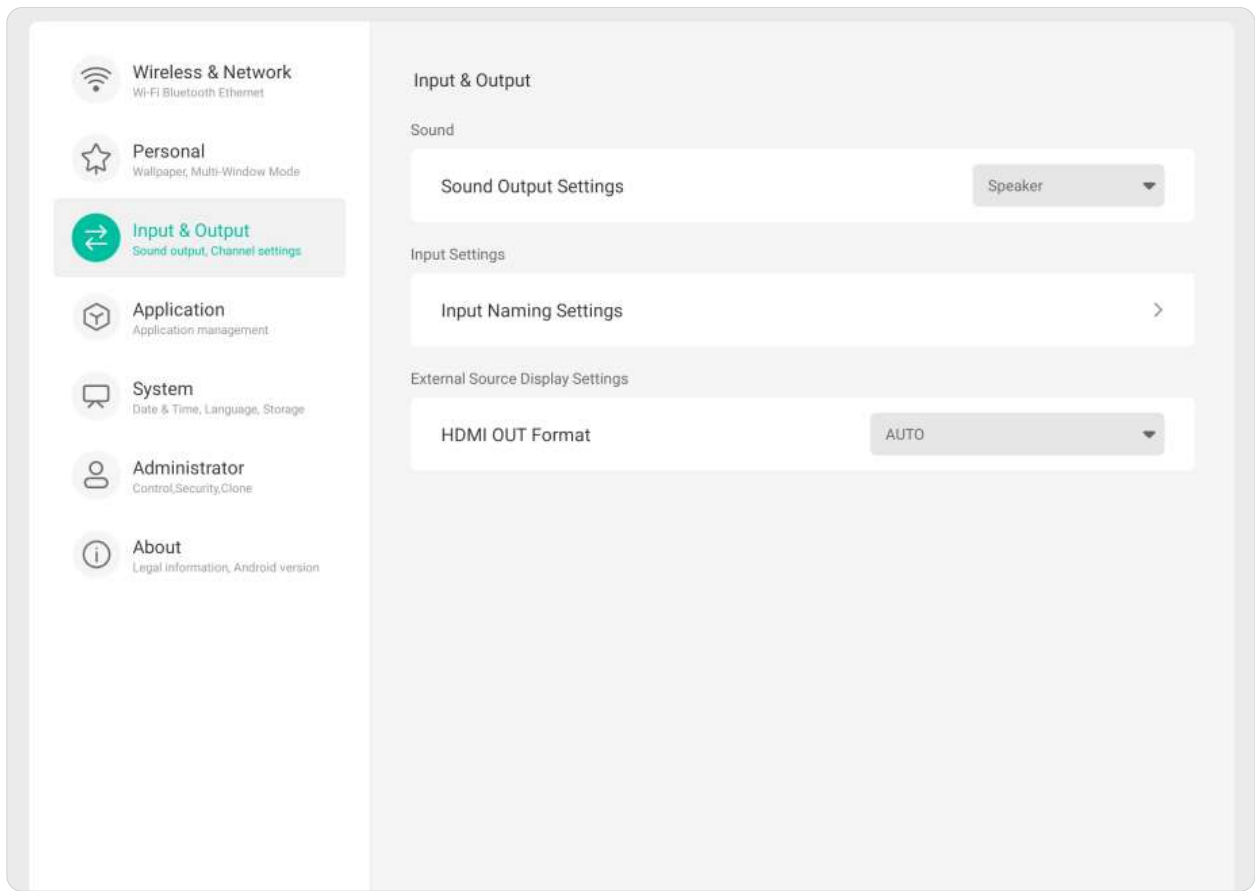

Sound

Adjust **Touch Sound** and **Sound Output Settings**.

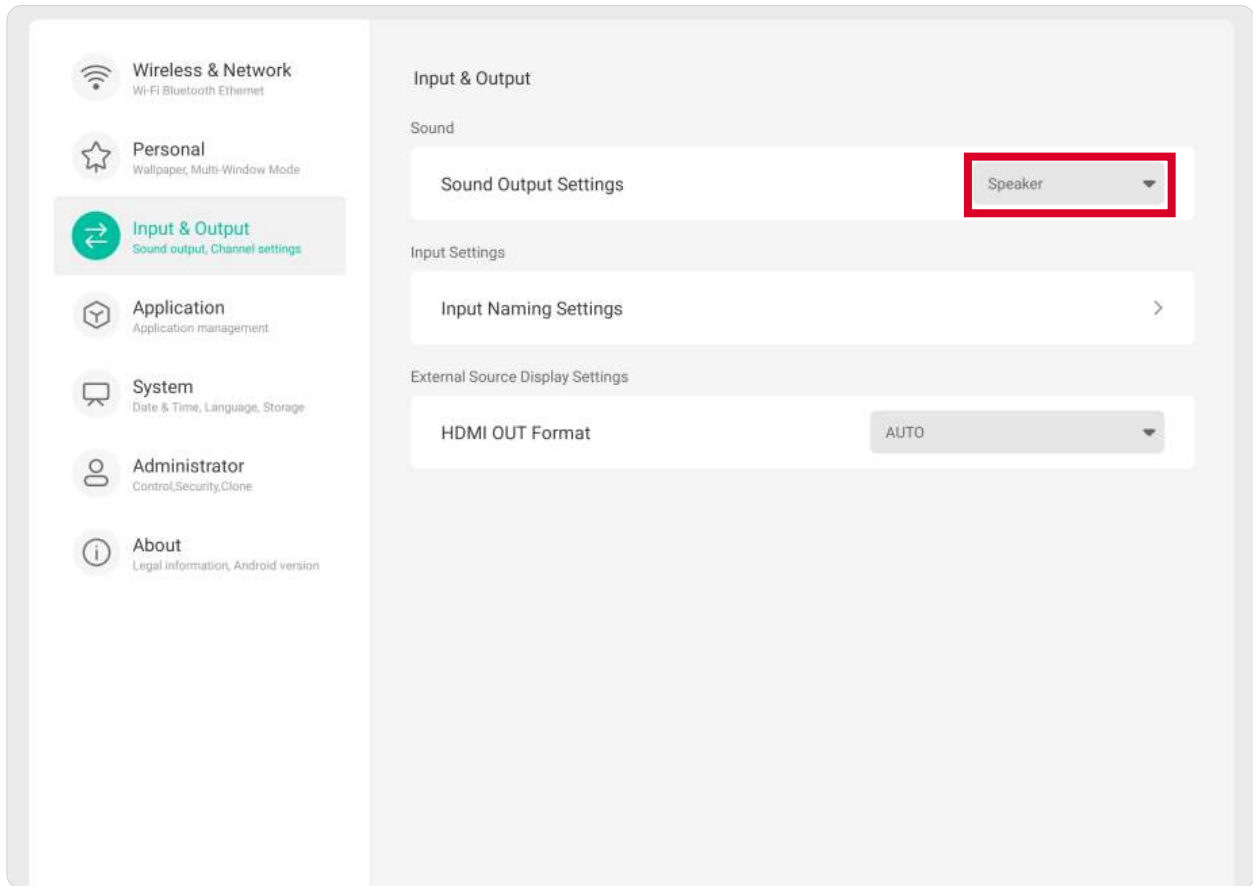

Input Settings

Set labels for each input source that will be easily recognized when displayed by adjusting **Input Naming Settings**.

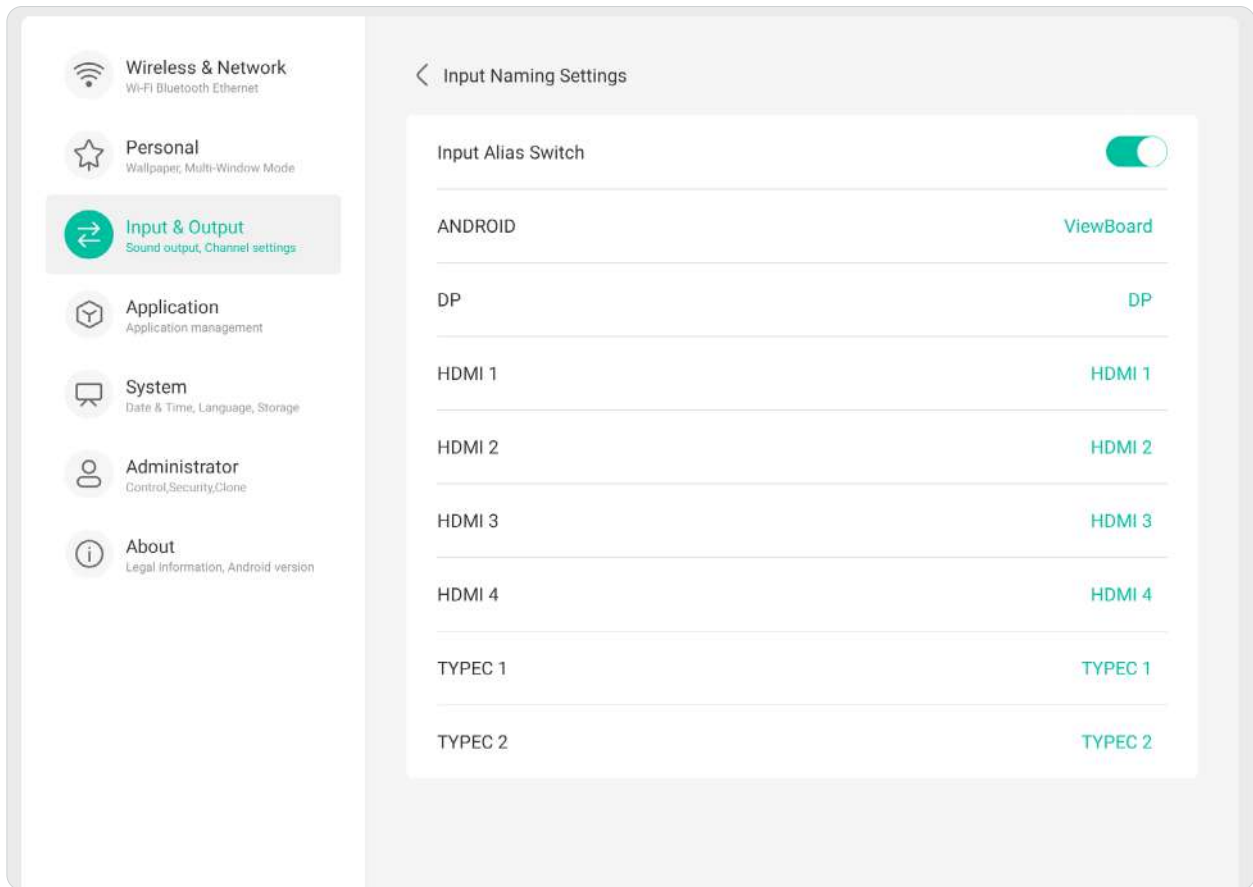

External Source Display Settings

Adjust the **HDMI OUT Format** resolution and timing settings to: 3840 x 2160 @ 60Hz or 1920 x 1080 @ 60Hz.

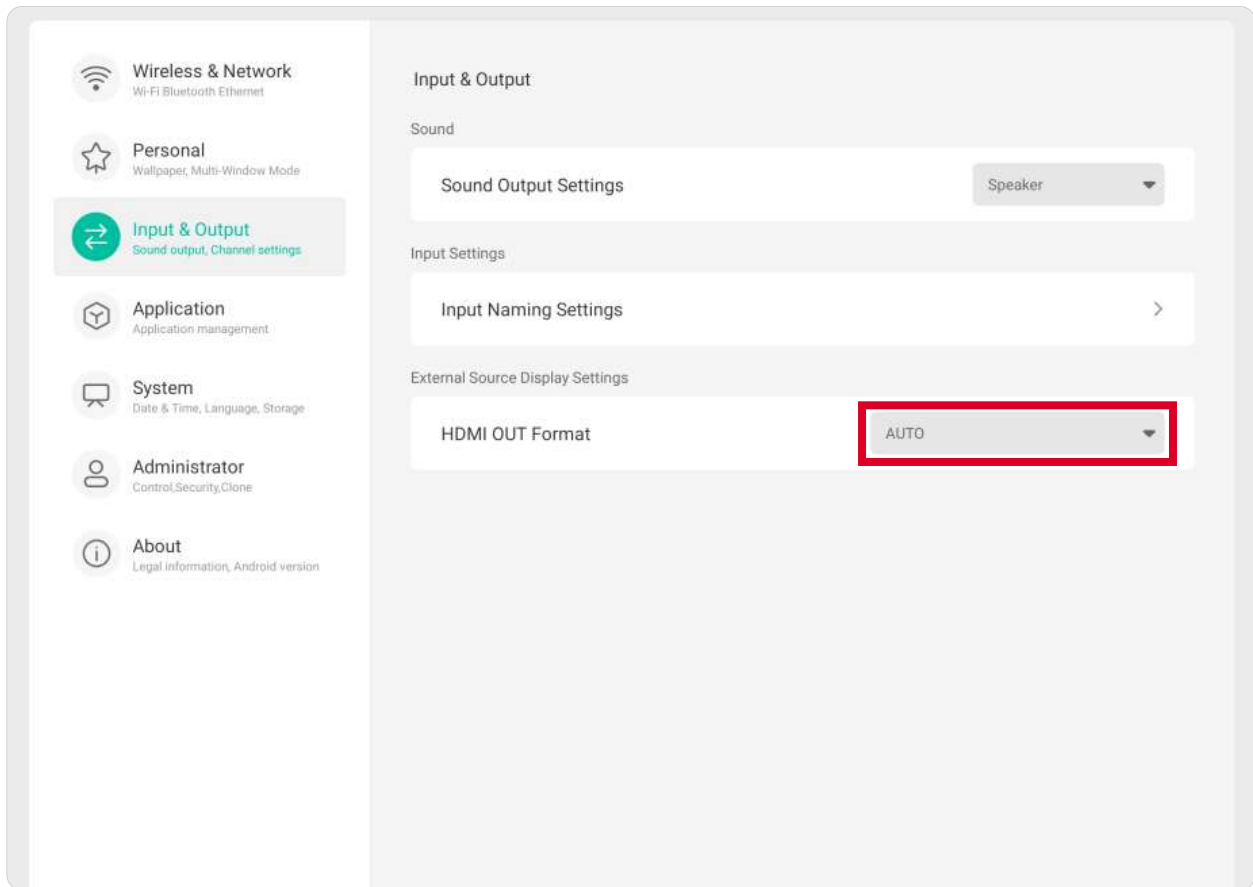

Application

View application information and force stop, uninstall, move to USB storage, clear data, clear cache, and clear defaults.

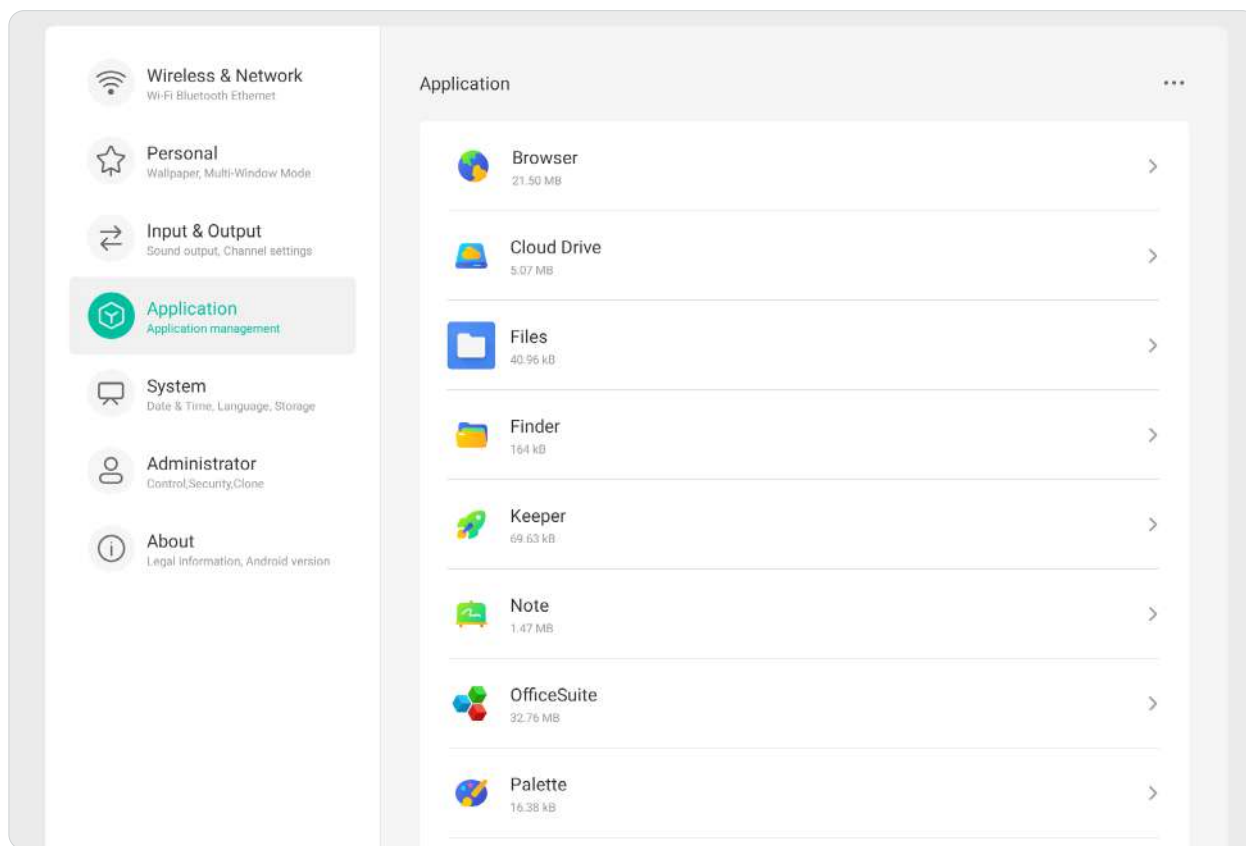

NOTE:

- Pre-loaded applications cannot be uninstalled.
- Not all applications support the move to USB storage feature.
- Not all applications support Clear Defaults.

By touching a running application, you can see more information, stop, or report the application.

System

View and adjust **General**, **Display**, **System Tools**, **Startup & Shutdown**, and **Improvement** settings.

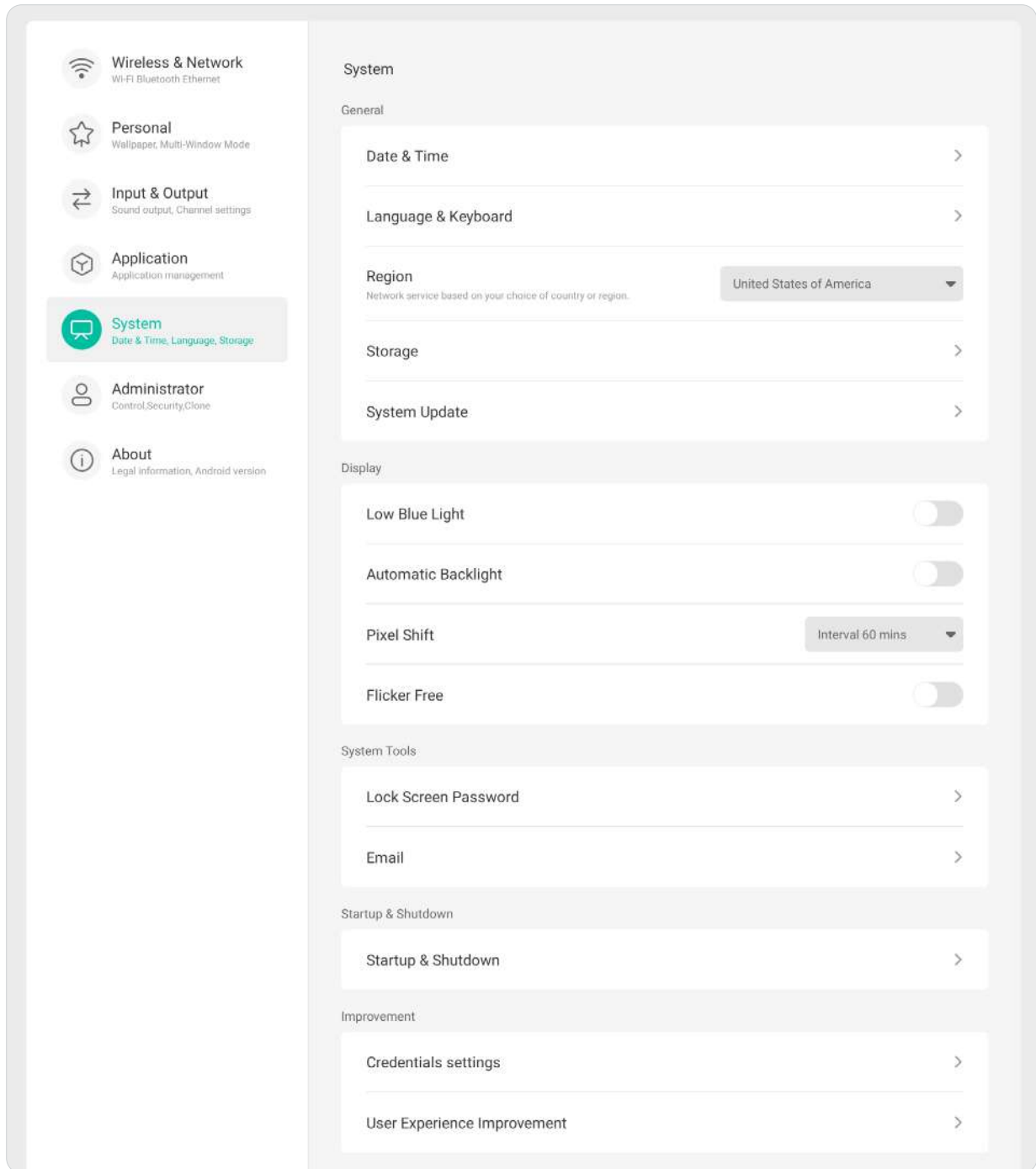

General

View and adjust the **Date & Time**, **Language & Keyboard**, **Region**, **Storage**, and **System Update** settings.

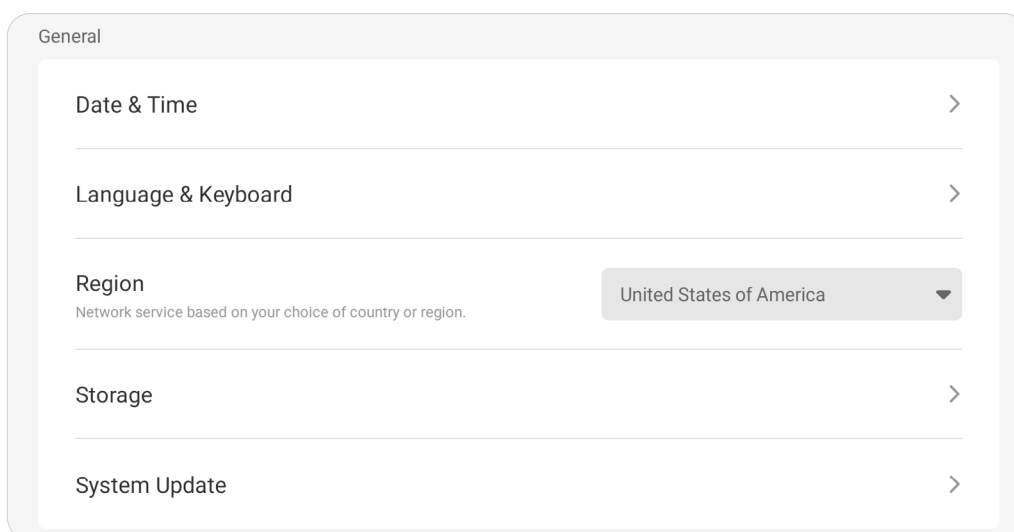

Date & Time

Set the system time and format.

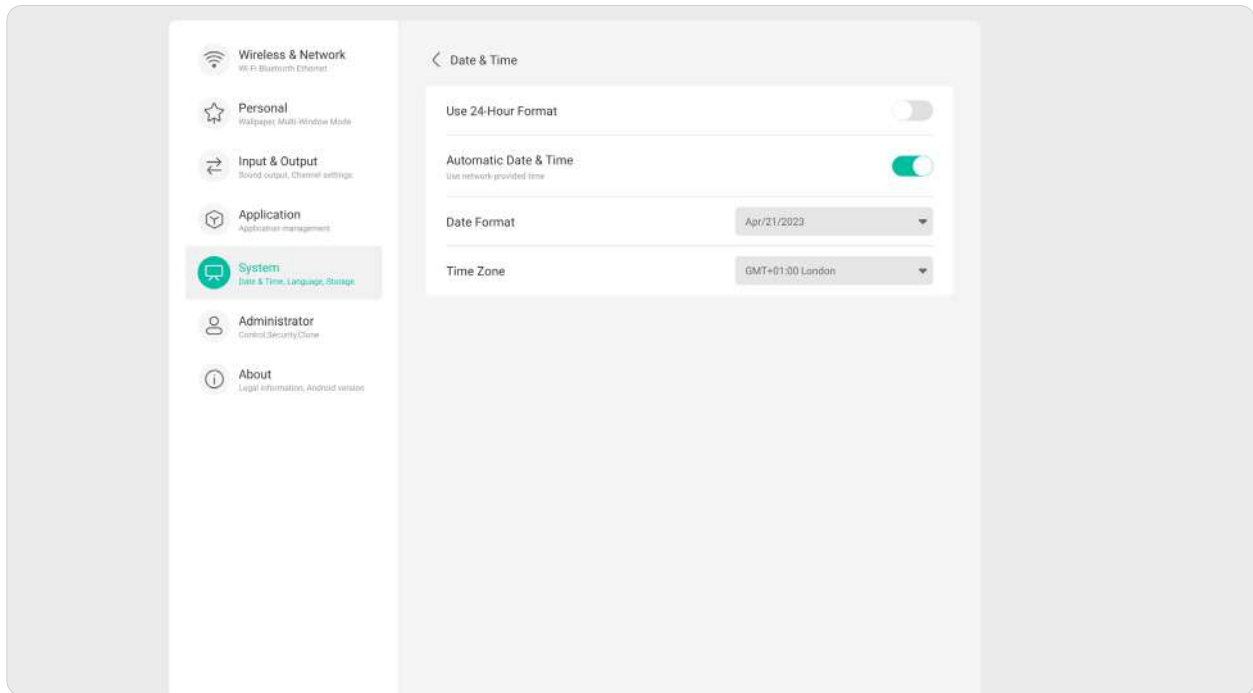

Language & Keyboard

Choose the preferred language and enable or disable the visual keyboard

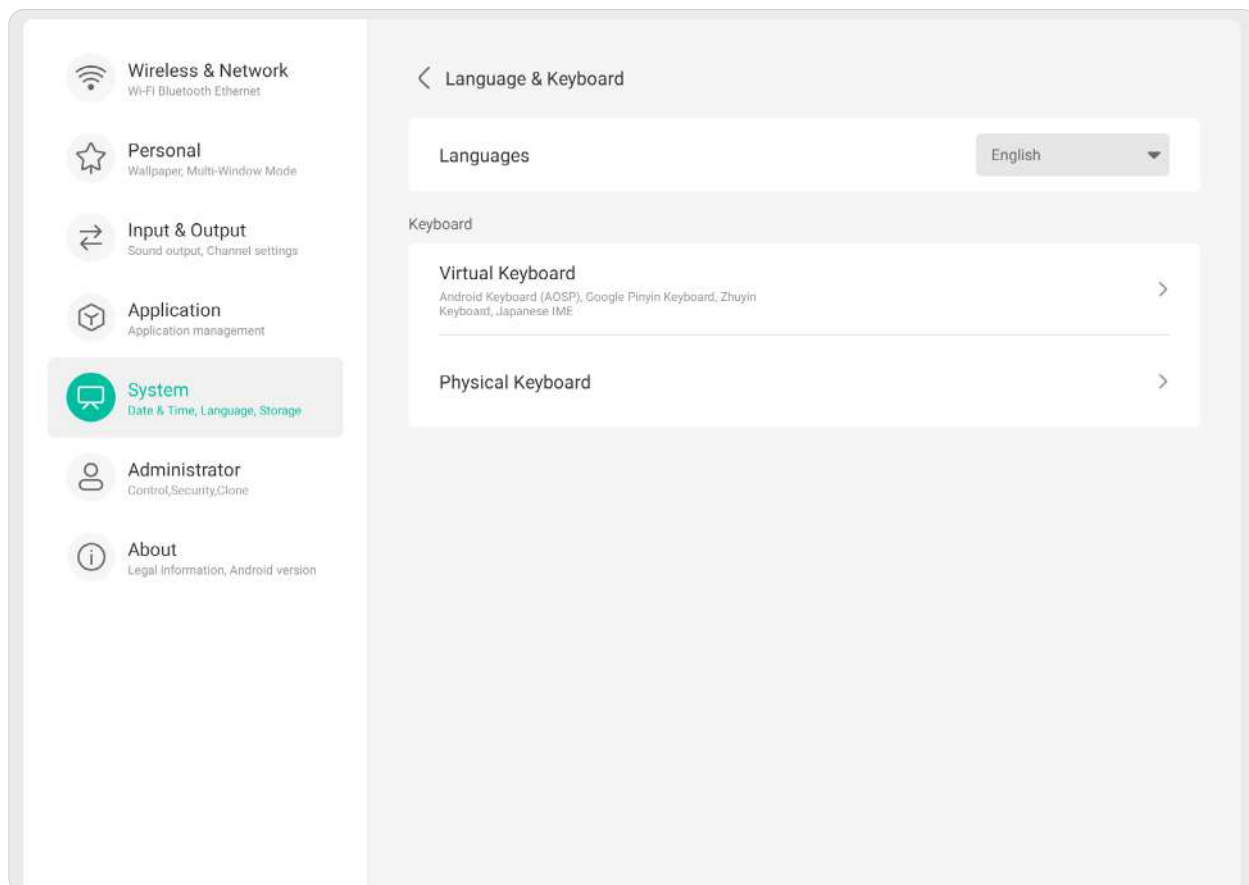

Region

Use the drop-down list to set the region for your network service.

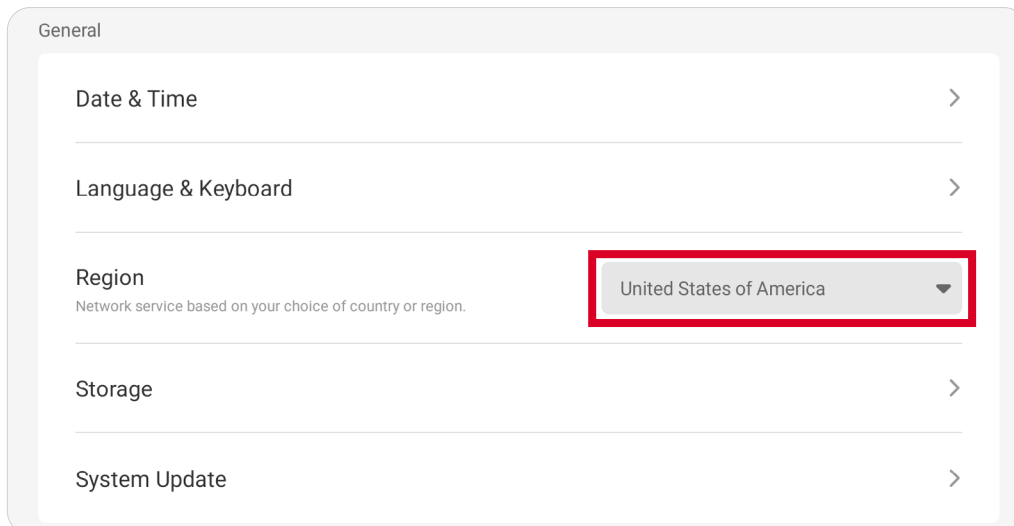

Storage

Check the storage space status of the display (internal) and any connected external storage devices.

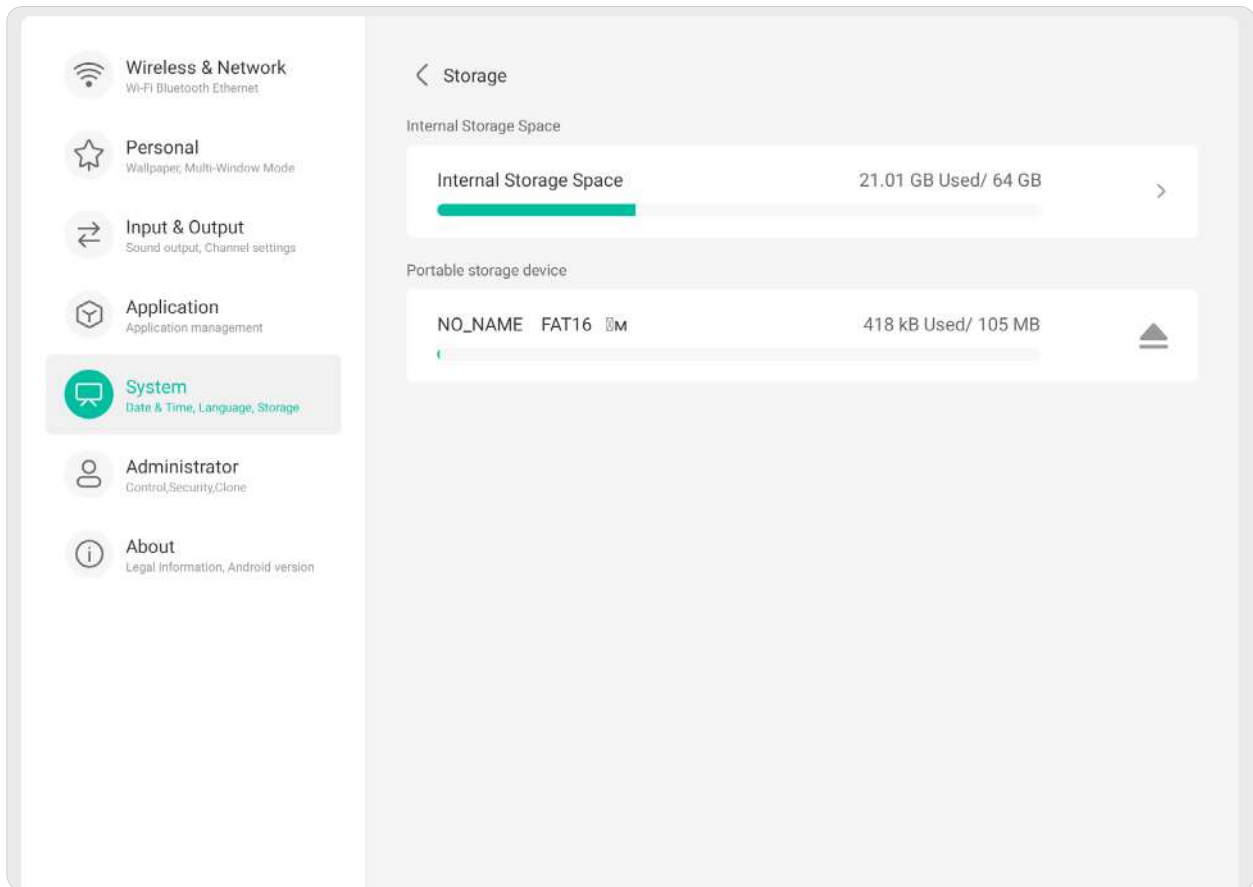

System Update

The display automatically searches for software updates whenever it is connected to the Internet (OTA). With just one click, users can update their software version.

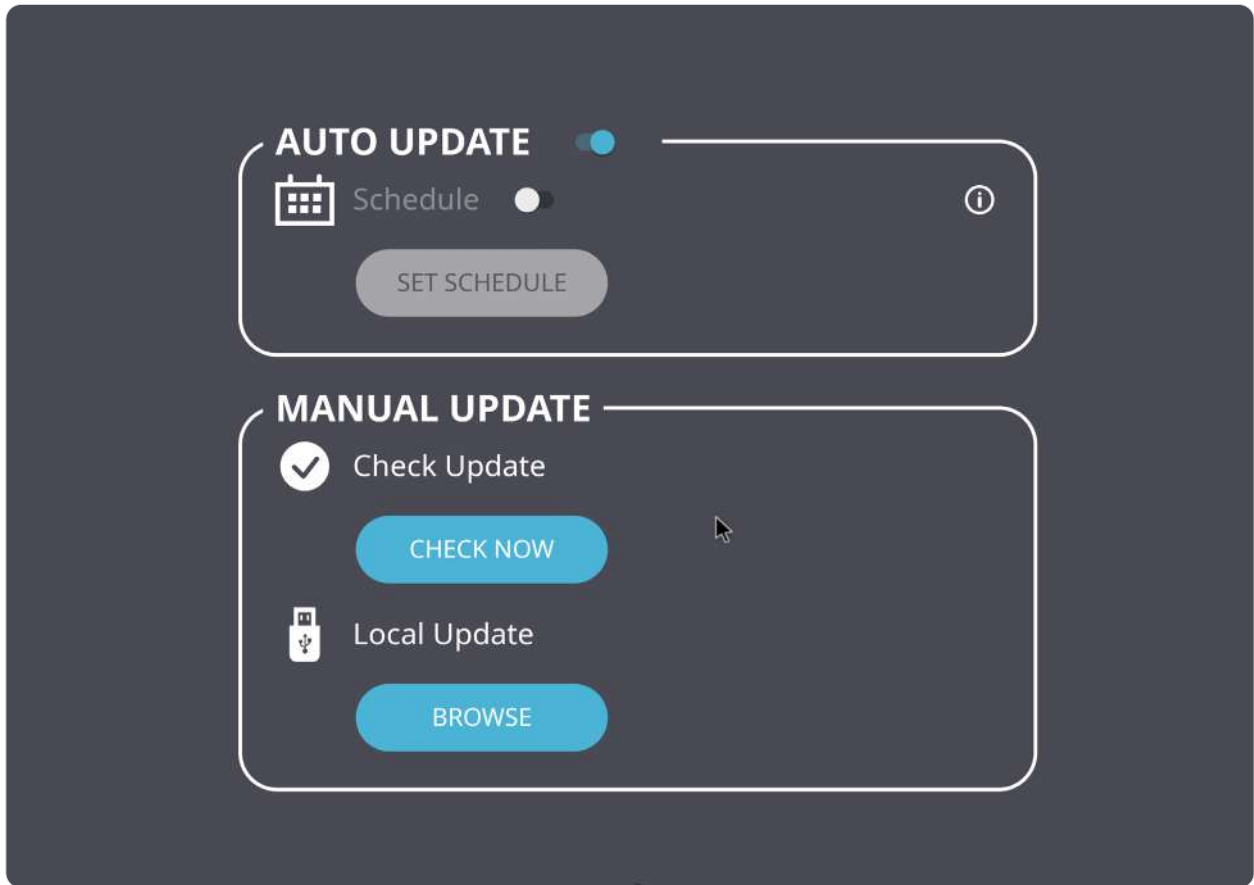

Display

Set the **Low Blue Light**, **Automatic Backlight**, **Pixel Shift**, and **Flicker Free** settings.

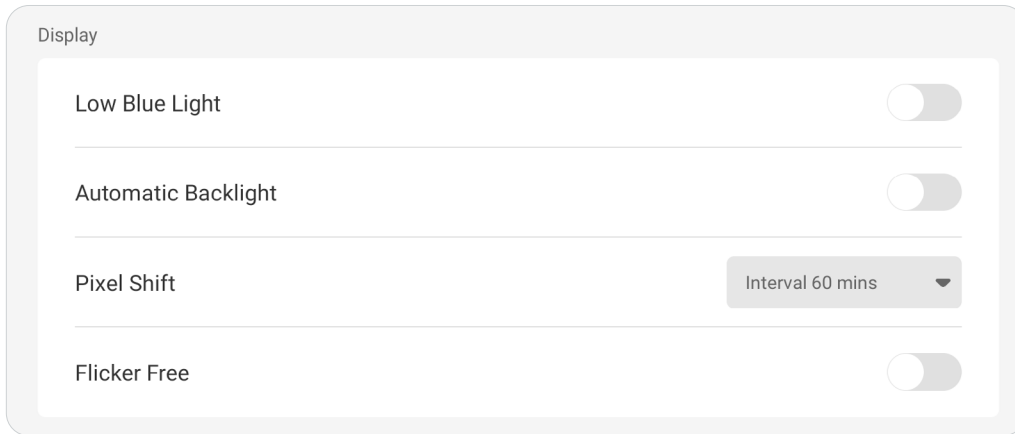

Item	Description
Low Blue Light	Adjusts the filter that blocks high-energy blue light for a more comfortable viewing experience.
Automatic Backlight	Automatic brightness adjustment. Adjusts maximum brightness according to ambient light levels.
Pixel Shift	Reduce the possibility of screen burn-in. This setting allows the user to program the time between movements of the picture in minutes.
Flicker Free	Reduce or eliminate screen flicker, easing potential eye strain.

System Tools

Set the **Lock Screen Password** and set up an **Email** account.

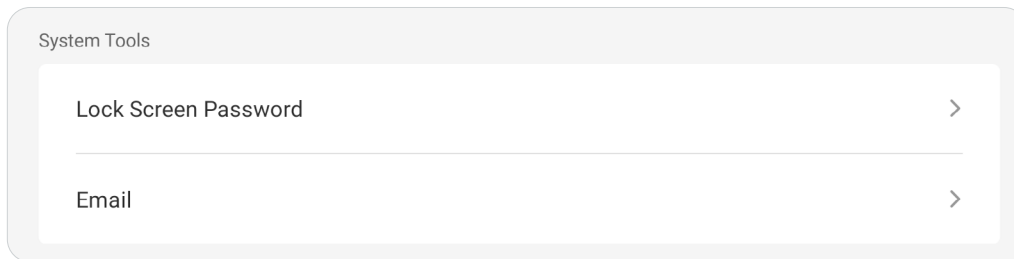



Lock Screen Password

Set a screen lock password and enable screen lock.

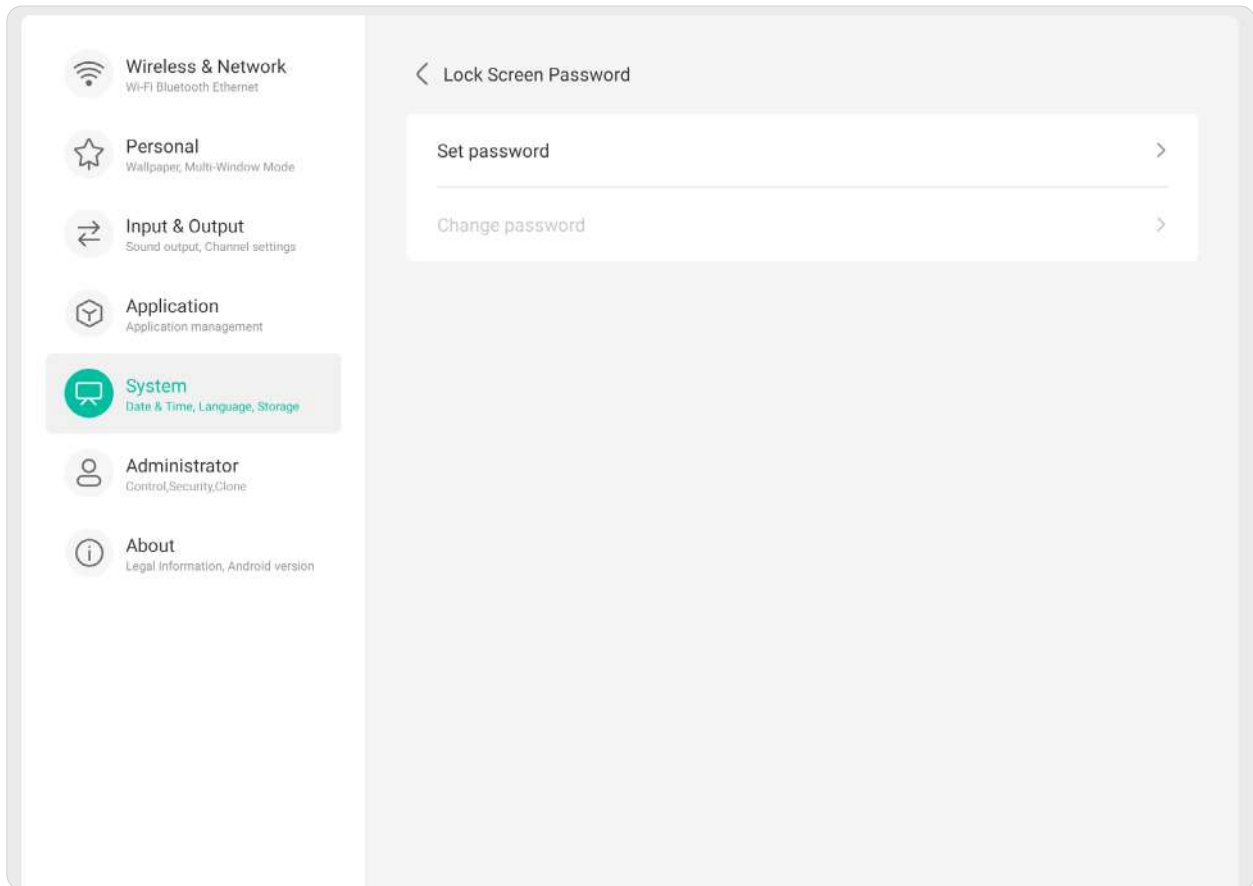
NOTE: If the password is forgotten, use the remote control and press **INPUT-0-2-1-4** to restore the password to default.



To set a screen lock password:

1. Go to: **Settings > System > System Tools > Lock Screen Password** for screen lock options, or select the **Screen Lock** icon () in the All Apps list.
2. Select **Set Password**, and input a new four (4) digit password. Then select **OK**. Now when selecting the **Screen Lock** icon (), the screen will be locked.

Email

Add an email account to the display.

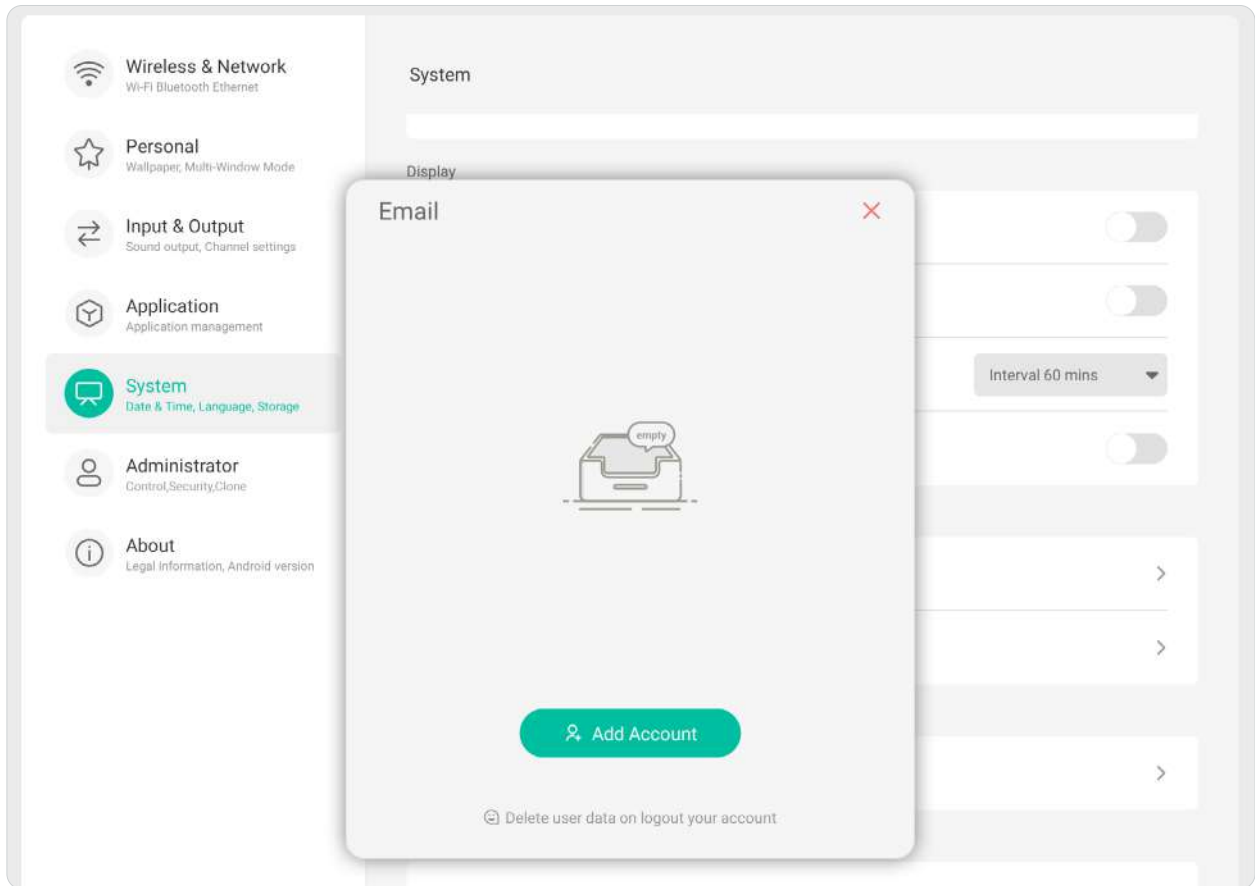

Startup & Shutdown

Set the **Startup Channel**, **Energy Saving** and **Timer Switch** settings.

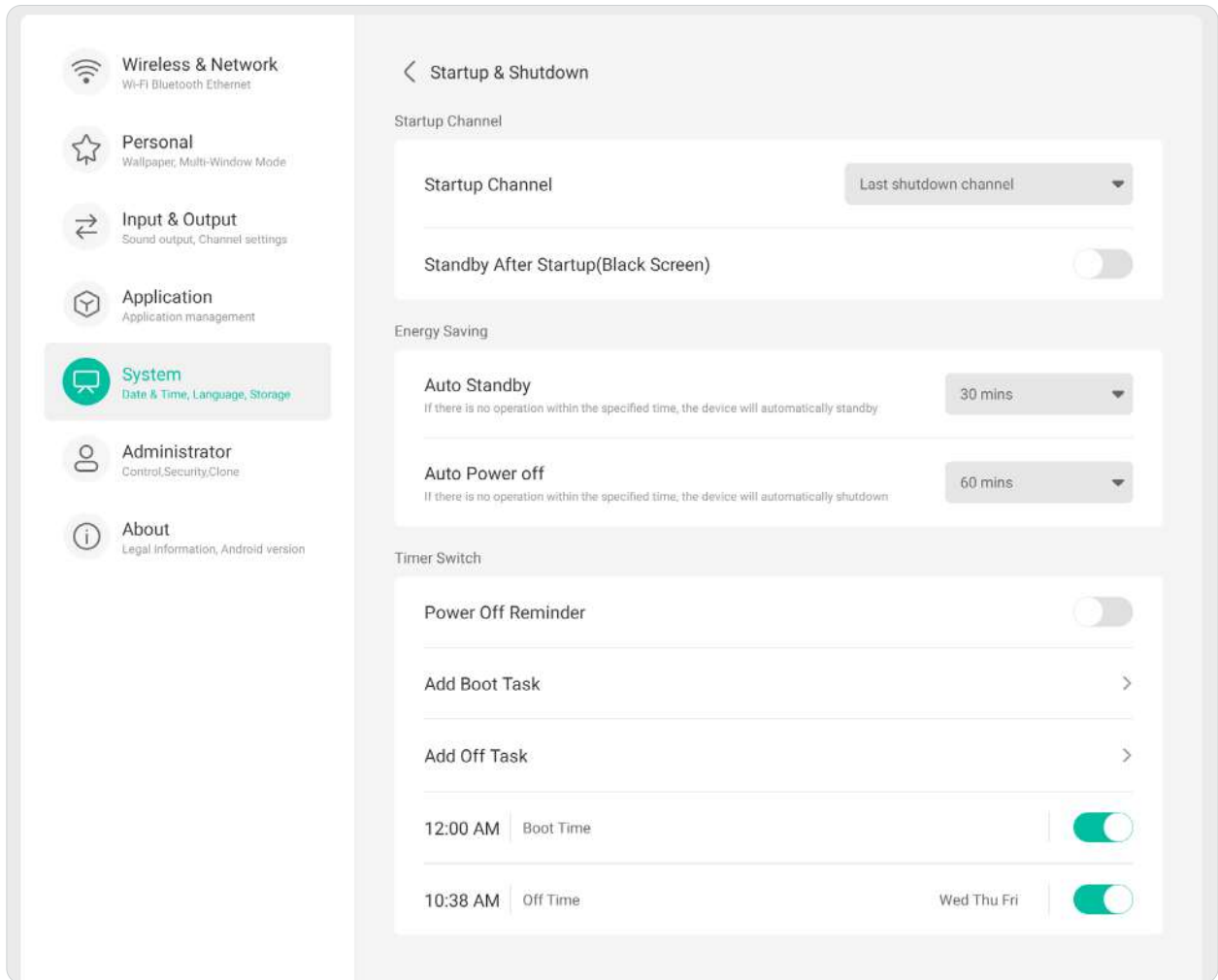

Startup Channel

Select the preferred input source when starting up the display, and set boot logo and video preferences.

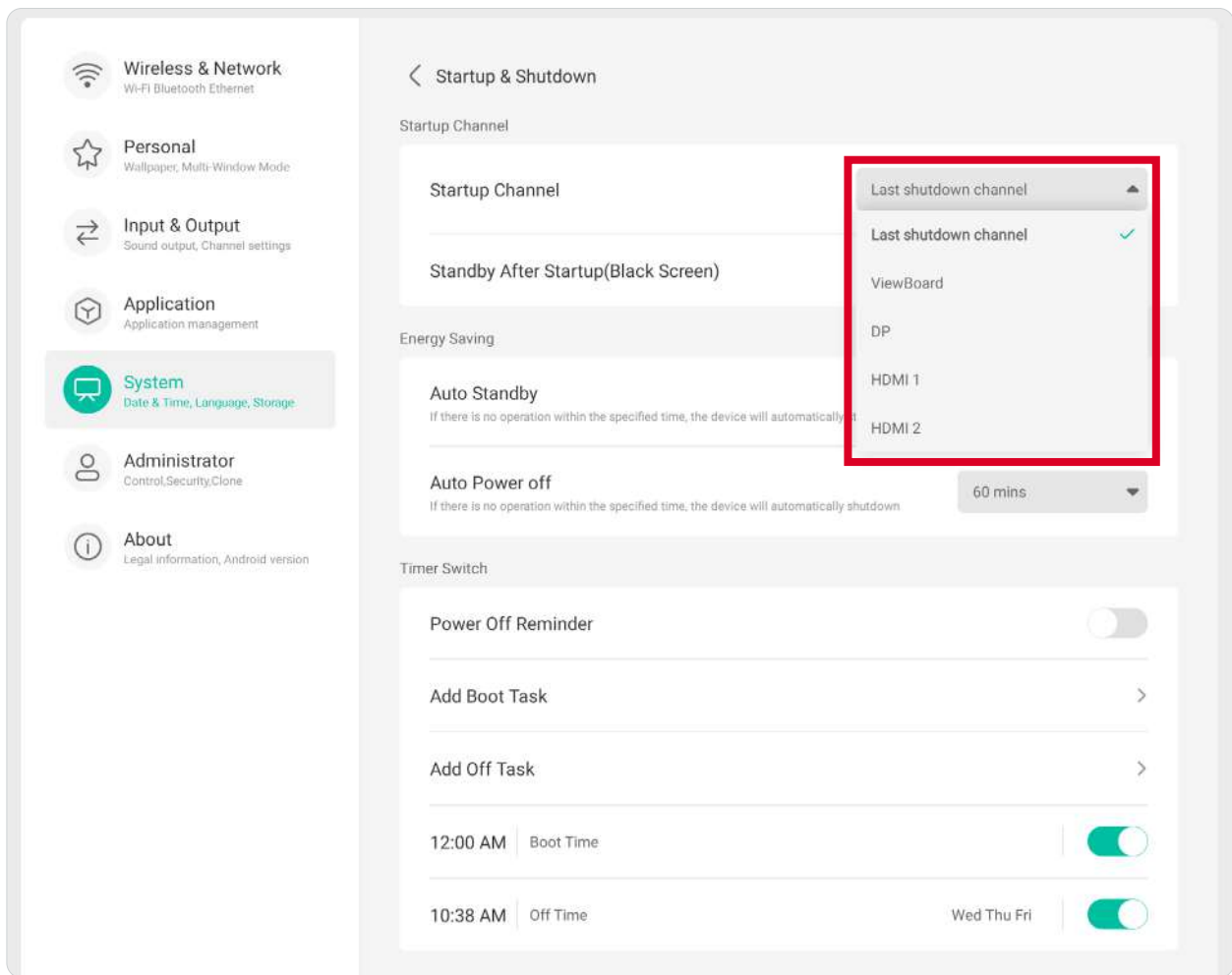

Energy Saving

Set **Auto Standby** and **Auto Power Off** timing to save power consumption when the display is not in use.

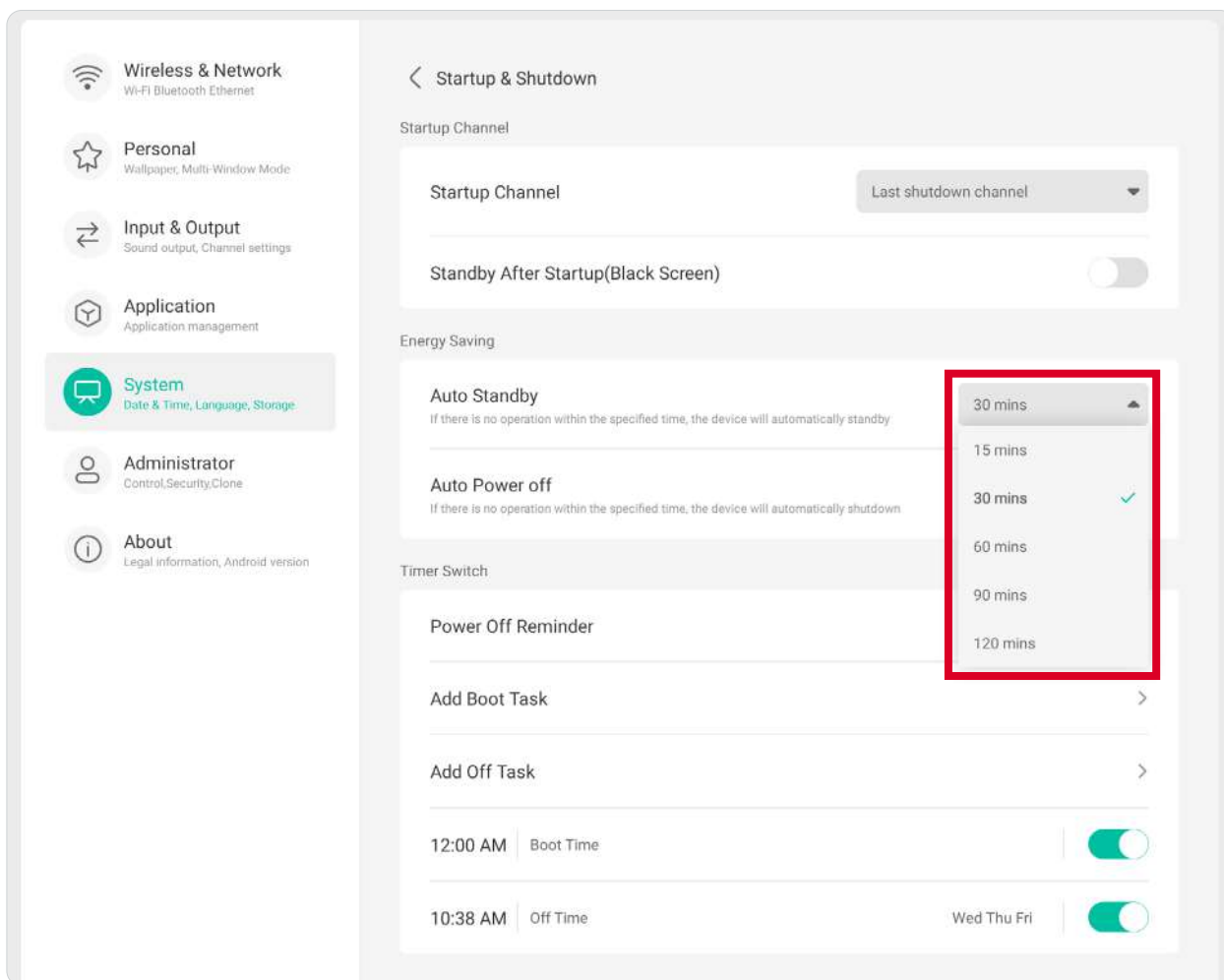

Timer Switch

Set up a **Power Off Reminder** and/or **Add Boot/Off Tasks**.

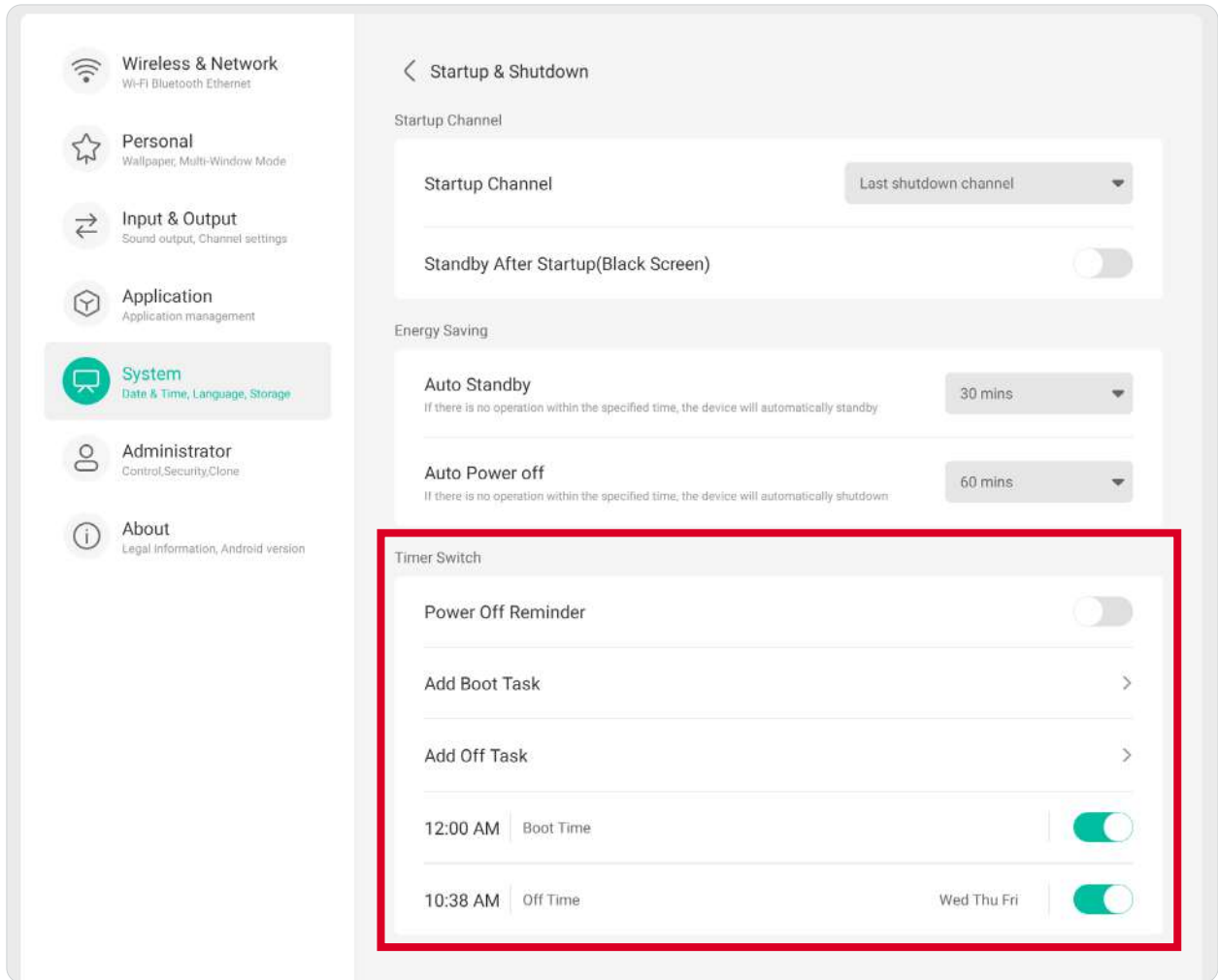

Improvement

Review the display's **Credentials** and **User Experience Improvement** settings.

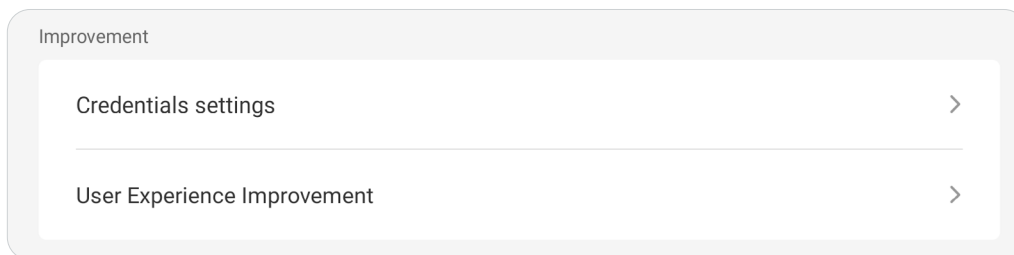

Credential Settings

Review **Trusted** and **User Credentials**, **Install from Storage**, and **Clear Credentials** settings.

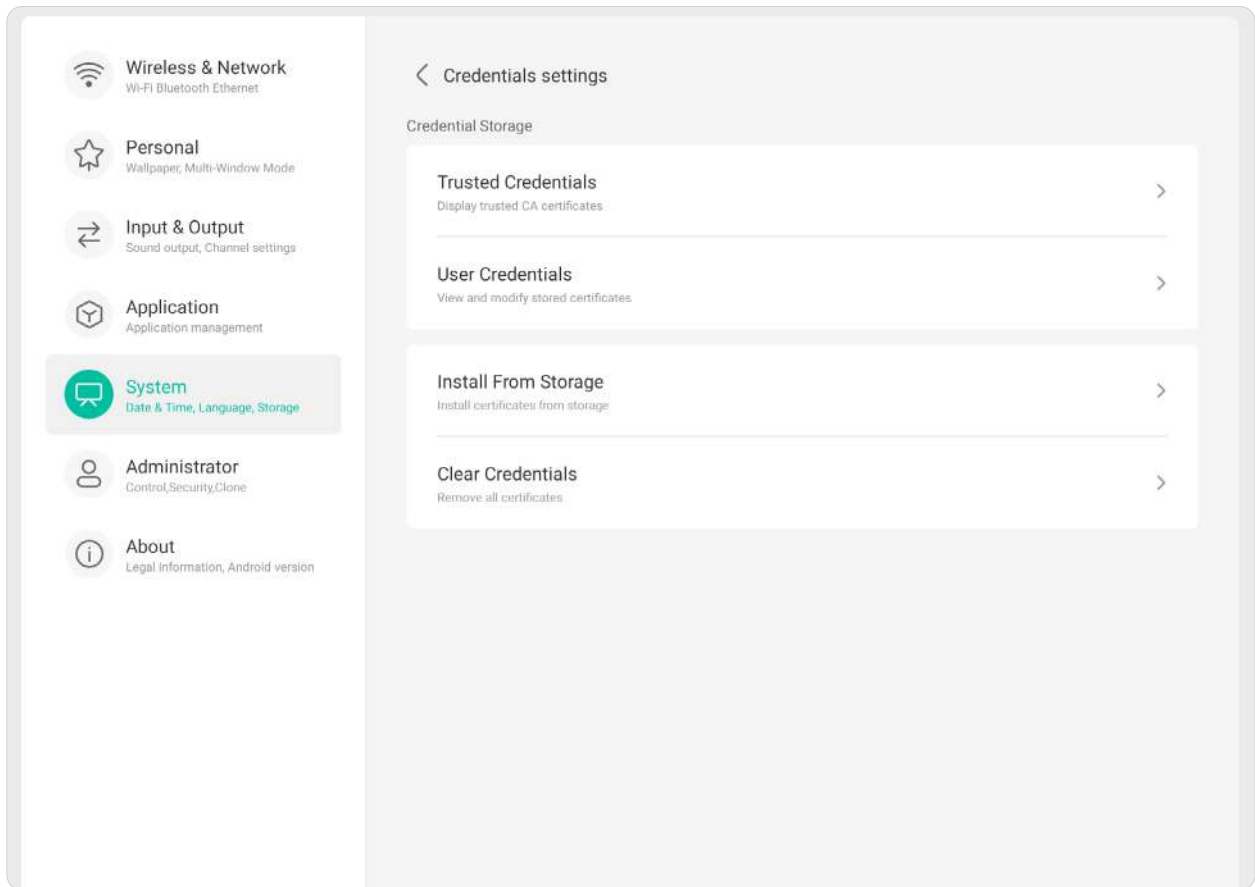

User Experience Improvement

Agree or disagree to have general statistical data about how the display is used collected to help improve services.

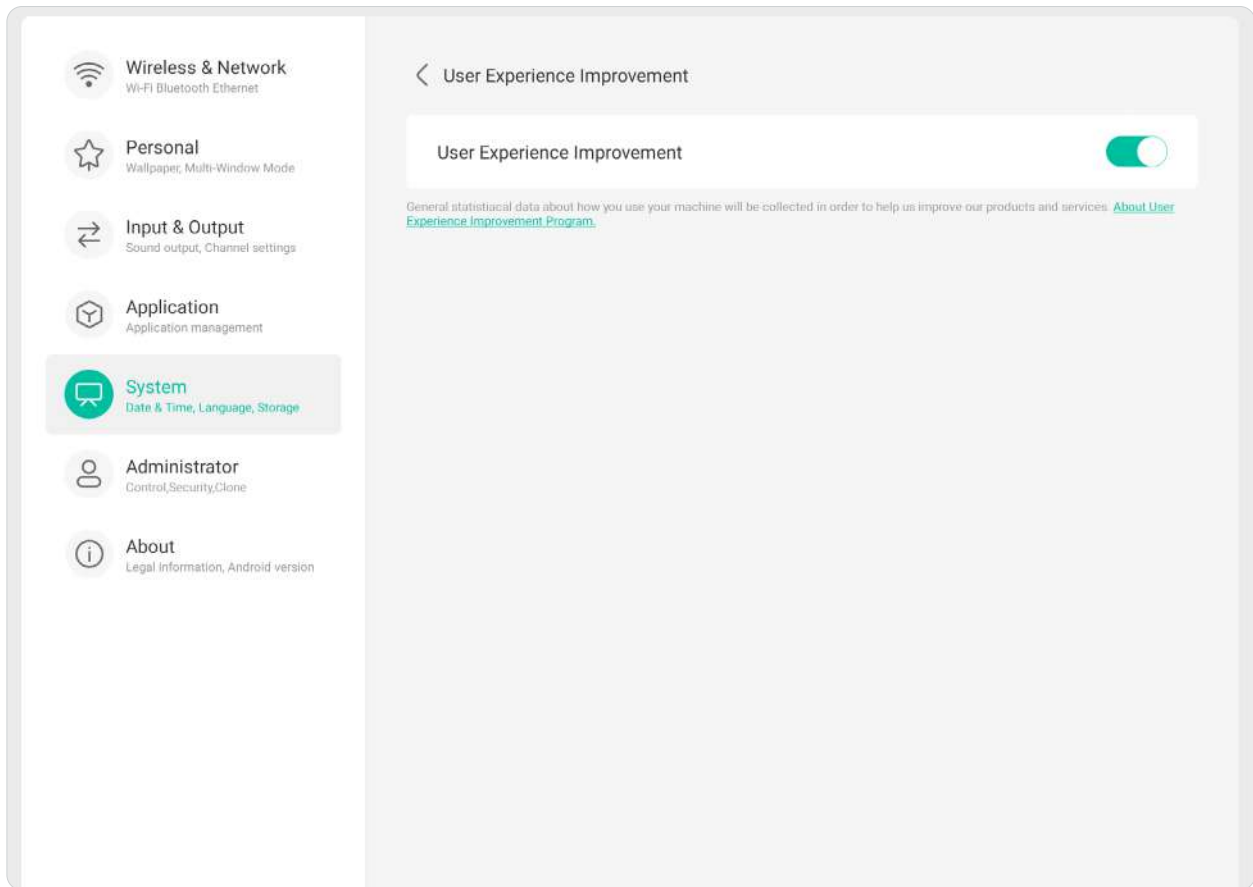

Administrator

View and set **Administrator**, **Control**, **Clone**, **Kiosk Mode**, and **Security** settings.

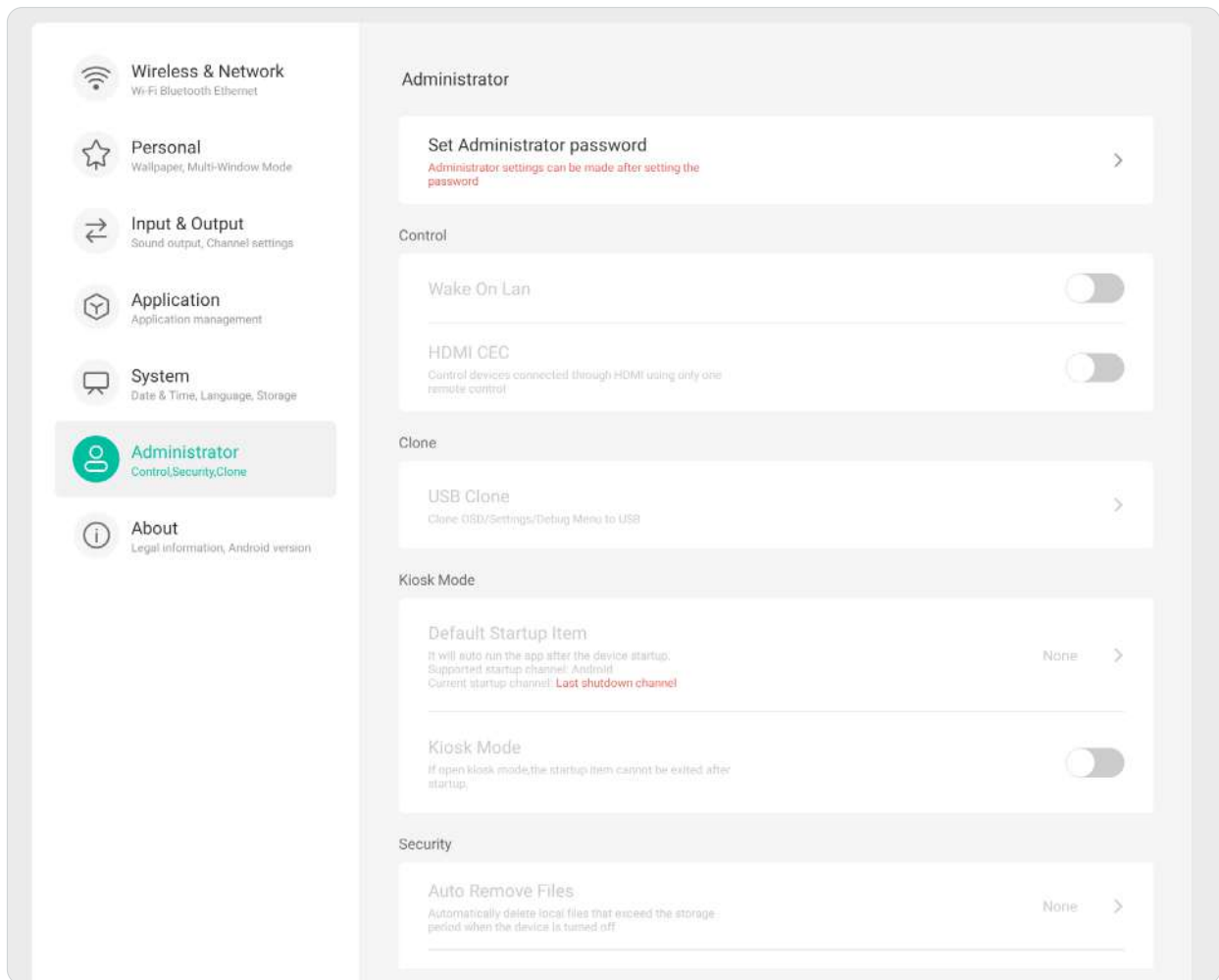

Administrator

Set an Administrator password to set up Administrator settings.

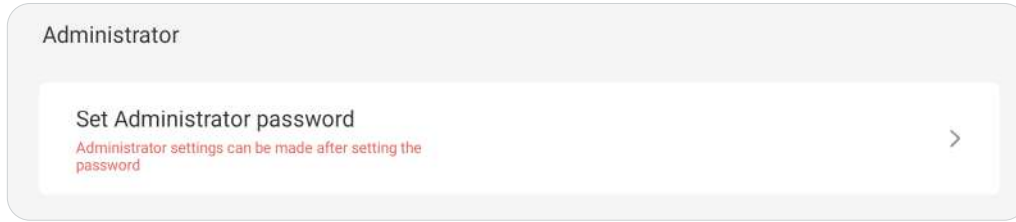

Control

Toggle **Wake On LAN** and **HDMI CEC ON** or **OFF**.

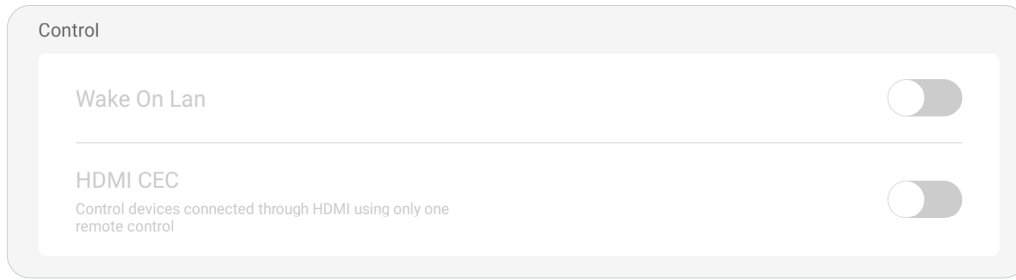

Item	Description
Wake On LAN	The display will turn on automatically after plugging in a LAN cable when the screen is off.
HDMI CEC	Enable/disable HDMI CEC which synchronizes device power ON/OFF operation via HDMI connection.

Clone

Copy OSD, Settings, and Debug Menu to a USB storage device.

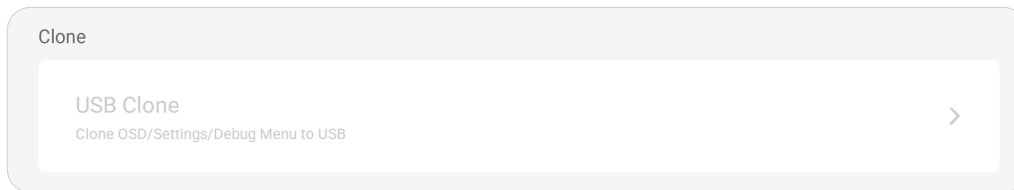

USB Clone

Copy OSD, Settings, and Debug Menu to a USB storage device.

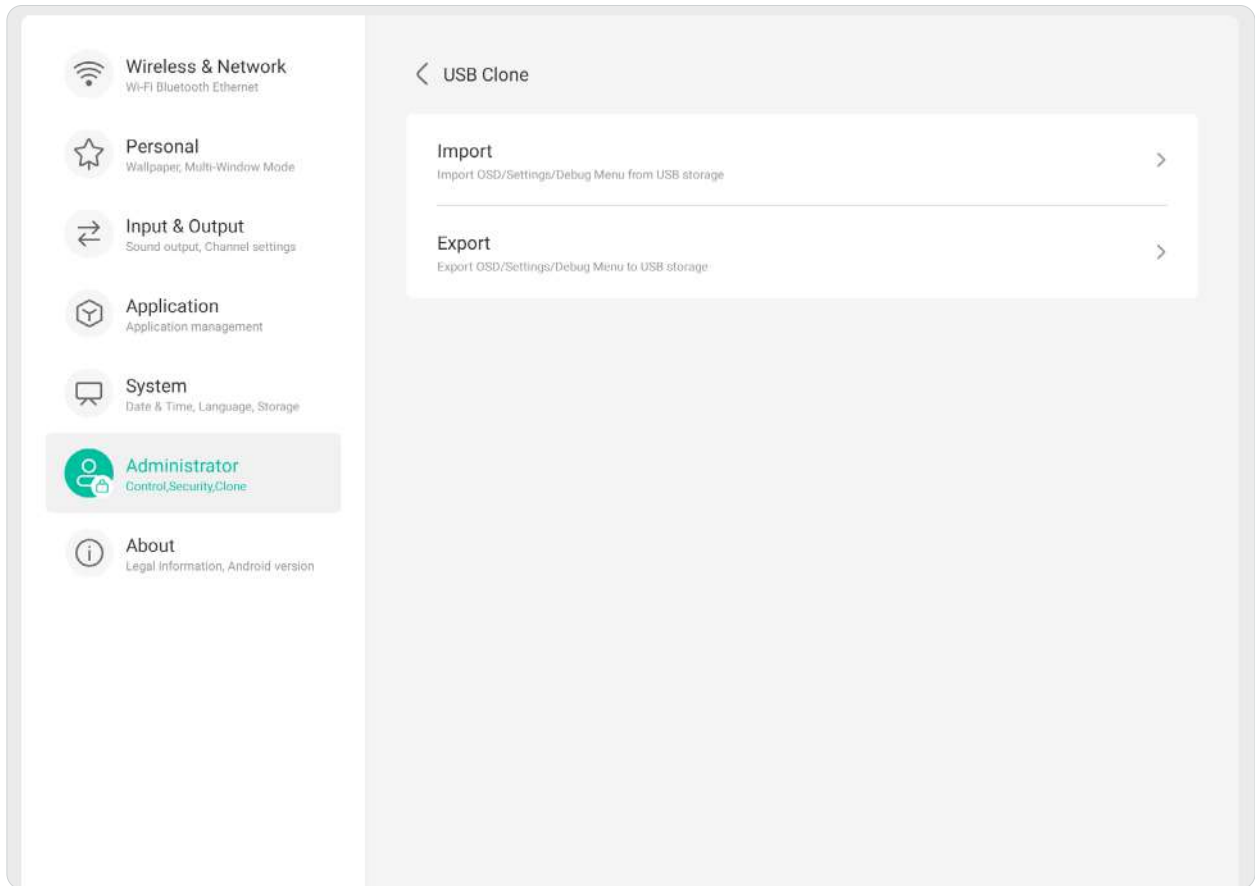

Kiosk Mode

Copy OSD, Settings, and Debug Menu to a USB storage device.

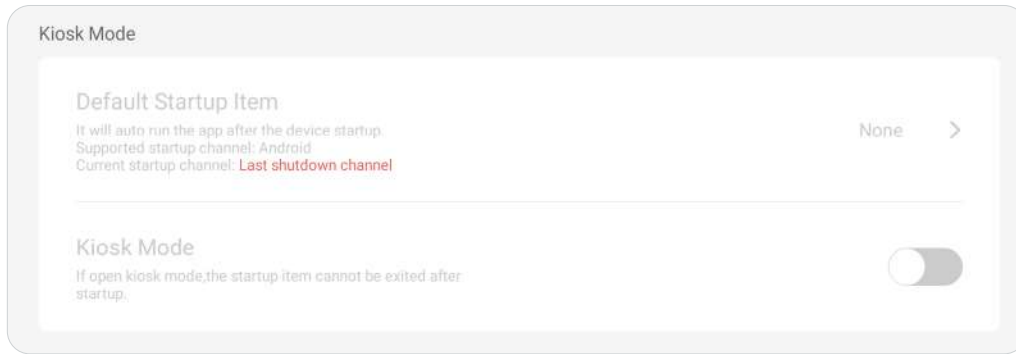

Item	Description
Default Startup Item	Select an application to run automatically when the display is turned on.
Kiosk Mode	When on, the selected Default Startup Item cannot be closed or exited from.

Security

Set up a set time period to automatically remove files and a lock for Settings, Network, USB and Unknown Sources settings.

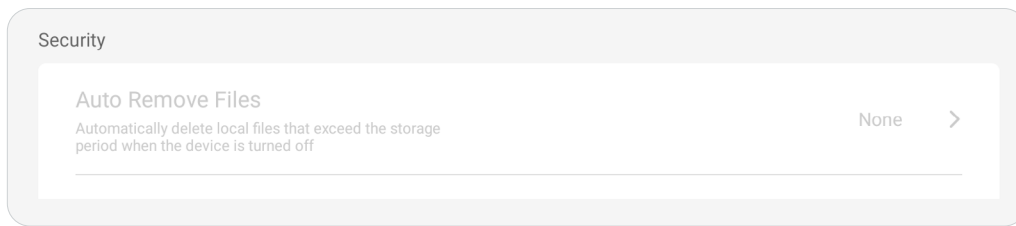

Auto Remove Files

Automatically delete local files that exceed the storage period set when the device is turned off.

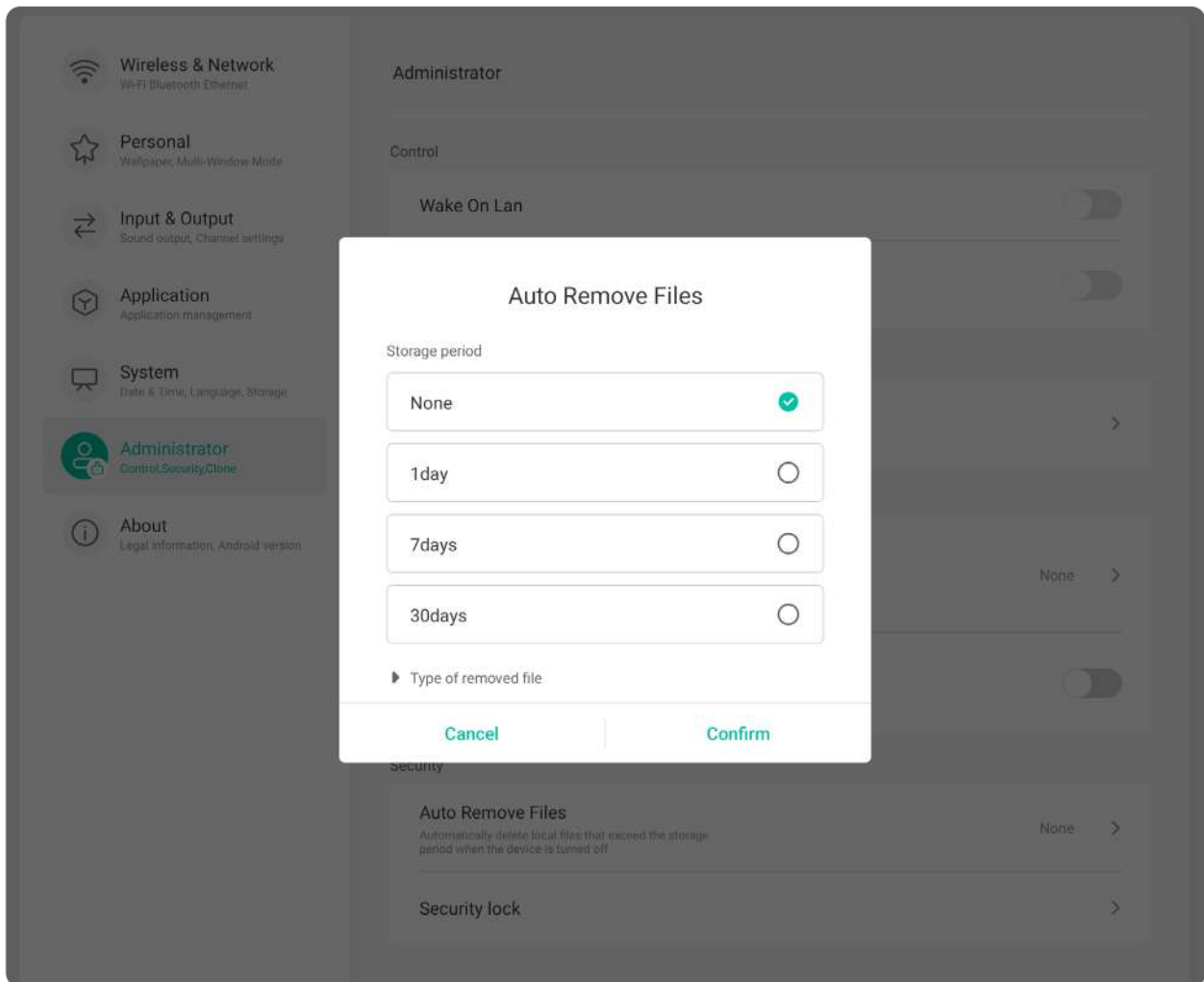

Security Lock

Set a password lock for Settings, Network, USB, and Unknown Sources settings.

About

View **Legal Information**, **Module Number**, **Android Version**, **Kernel Version**, and **Build Number**.

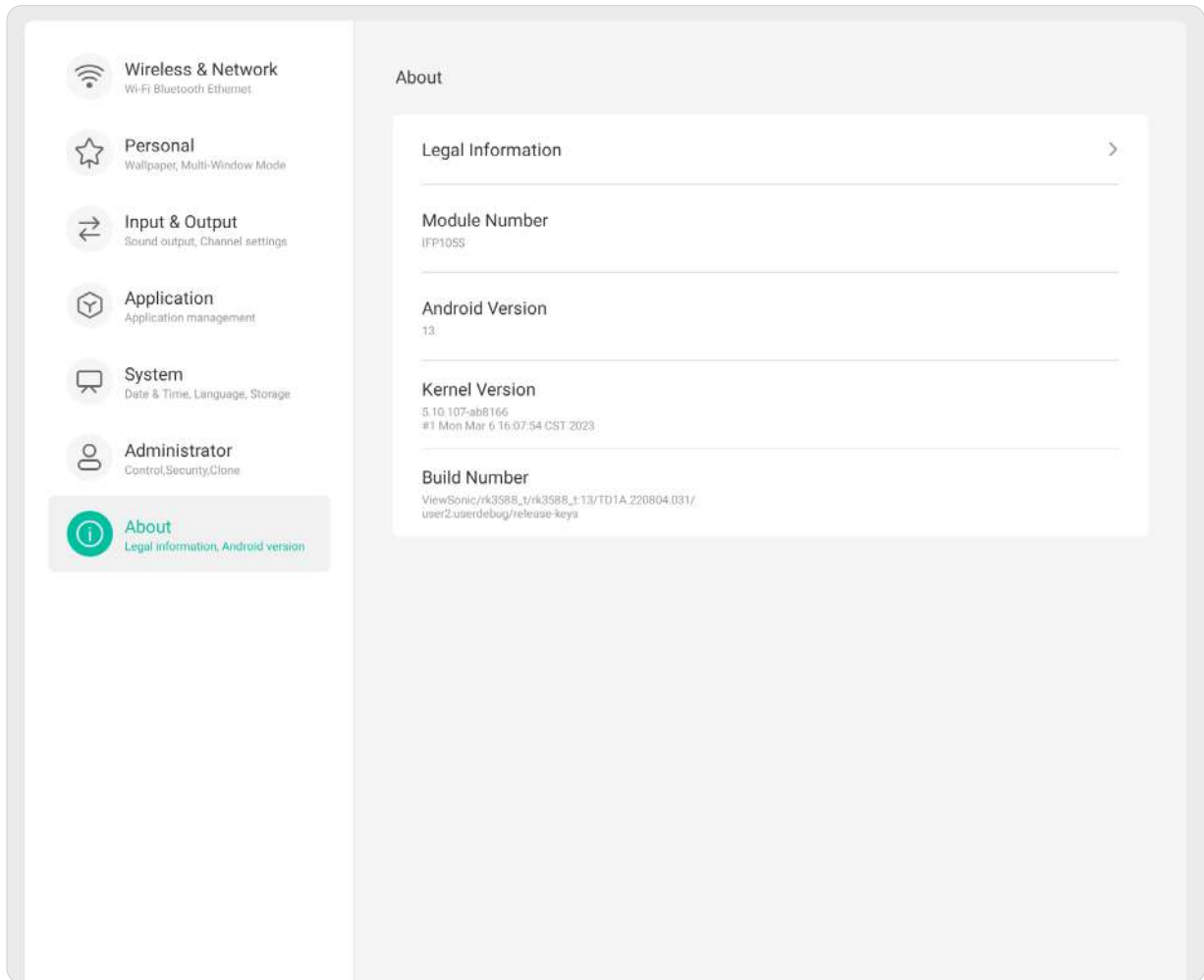

Pre-installed Applications and Settings

NOTE: Installed applications are subject to change (install, uninstall, update) without notice when the system is updated. Please contact your local customer service if you have any questions.

Record

Capture everything that is displayed on screen in a video format.

To launch the screen recording application:







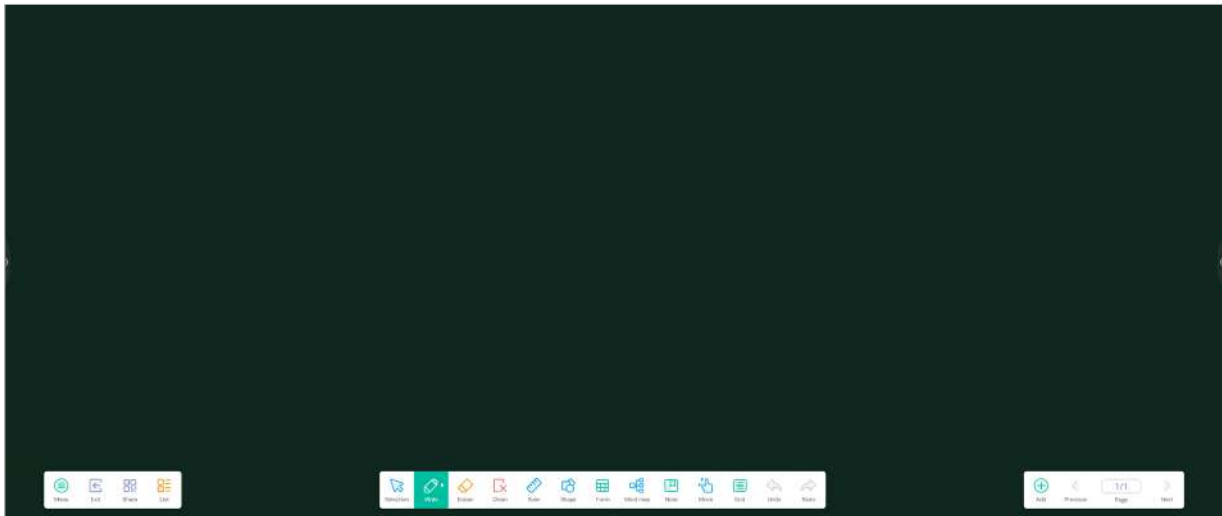



1. Select the **Record** icon () under **More**.
2. Select the preferred recording configurations.
3. Touch the check mark and a three (3) second countdown will begin. Screen recording will begin immediately after the countdown.
4. After stopping the recording, you will be able to preview the video, save it, or discard it.











Note

A digital whiteboarding application.



Toolbar

	Item	Description
	Menu	Create new, open, save, import and export files. Set up cloud storage, themes and adjust other settings.
	Exit	Close the Note application.
	Share	Share the canvas via QR code.
	List	Open a list of local files.
	Selection	Select objects, text, and other elements on the canvas.
	Write	Writing tools and customization options.
	Eraser	Erase objects.
	Clean	Clear the canvas.
	Ruler	Select from several ruler types.
	Shape	Create 2D and 3D shapes.
	Form	Create a form and set the quantity of columns and rows.

Item		Description
	Mind Map	Create a mind map.
	Note	Create a sticker-type note.
	Move	Move the canvas.
	Grid	Create a grid.
	Undo	Undo the previous action.
	Redo	Redo the previous action.
	Add	Add a new canvas.
	Previous	Go to the previous page (if the canvas has multiple pages).
	Page	Indicates the page number.
	Next	Go to the next page (if the canvas has multiple pages).

vCast

Working with ViewBoard® Cast software (vCast, vCast Pro, and vCastSender), the vCast application will allow the ViewBoard to receive laptop screens (Windows/Mac/Chrome) and mobile (iOS/Android) users' screens, photos, videos, annotations, and camera(s) that are using the vCastSender application.

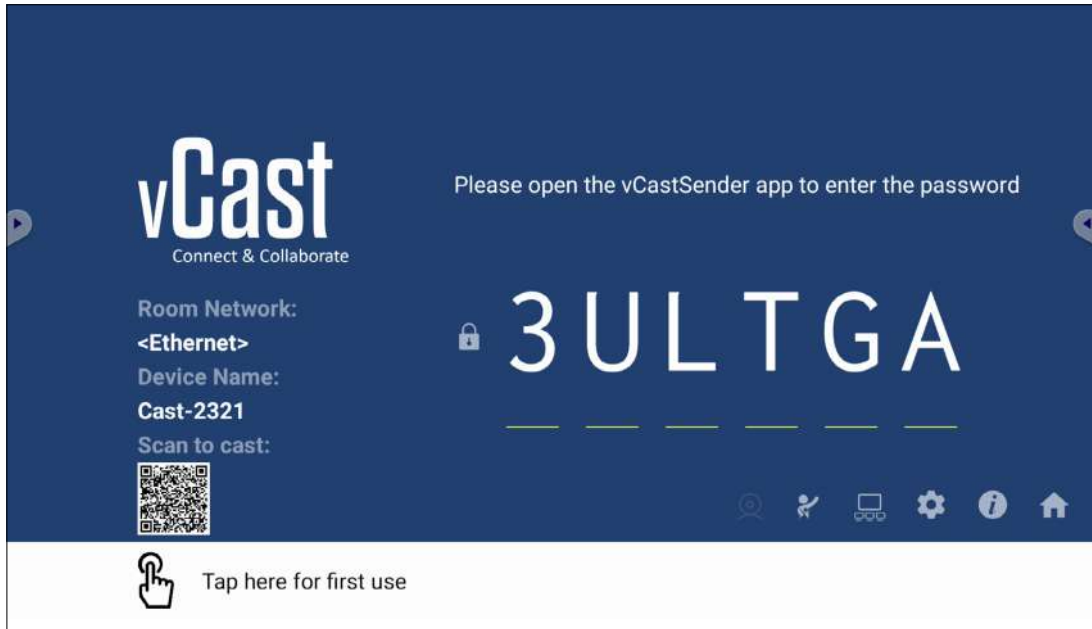

Network Information

- ViewBoard® Cast software, laptops, and mobile devices can connect to both the same subnet and cross subnet by entering the on-screen PIN code.
- Connected devices will show up under **Device List** on the same subnet connection.
- If the device does not show up under **Device List**, users will need to key-in the on-screen PIN code.
- **Ports:**
 - » TCP 56789, 25123, 8121 & 8000 (Controlling message port & client device audio transfer)
 - » TCP 8600 (BYOM)
 - » TCP 53000 (Request share screen)
 - » TCP 52020 (Reverse control)
 - » TCP 52025 (Reverse control for ViewBoard Cast Button)
 - » TCP 52030 (Status sync)
 - » UDP 48689, 25123 (Device searching and broadcast & client device audio transfer)
 - » UDP 5353 (Multicast search device protocol)
- **Port and DNS for Activation:**
 - » Port: 443
 - » DNS: <https://vcastactivate.viewsonic.com>
- **OTA Service**
 - » Server Port: TCP 443
 - » Server FQDN Name: <https://vcastupdate.viewsonic.com>

Display Group Settings

To adjust the Display Group Settings, select the Display Group icon (🖥️) located in the lower-right corner of the screen.

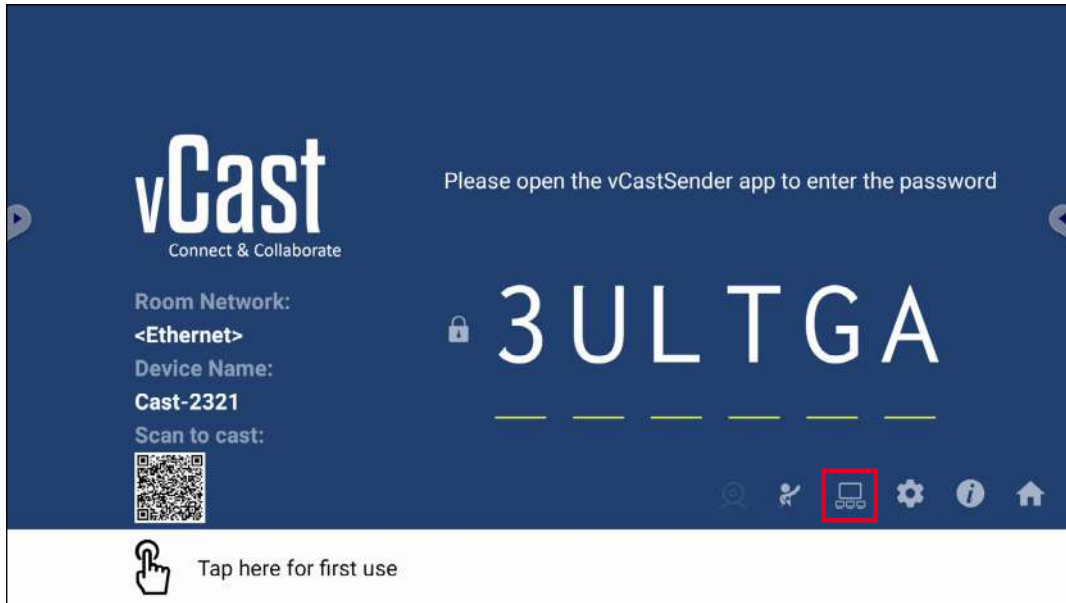

1. Toggle the “Turn On/Off Display Group” ON to enable the Display Group feature.

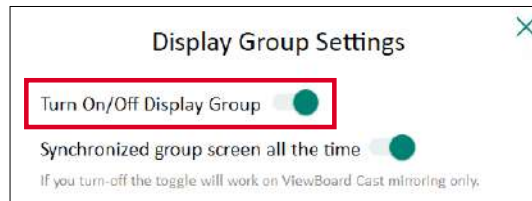

NOTE: Other preinstalled ViewBoard Cast devices in the same network will be listed.

2. Select the devices you want to join the display group and select **OK** to save the settings.

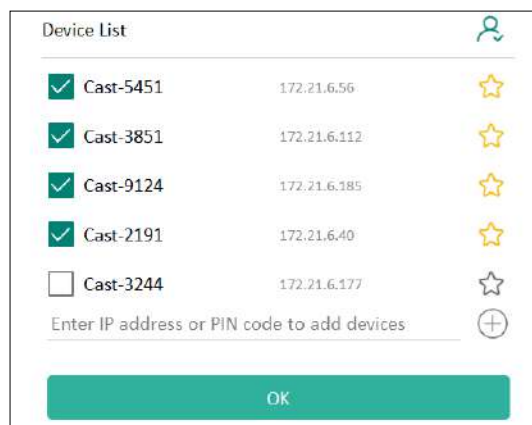

NOTE:

- If the devices you want to group are not listed, you can enter their respective IP address or connecting PIN code.
- The Display Group maximum device limit is six devices.

3. If you frequently connect to the same device, you can select the Star icon (★) next to the device to add it to your frequently connected devices list, “My List of Devices in Group”, for easier Display Group setup and management.

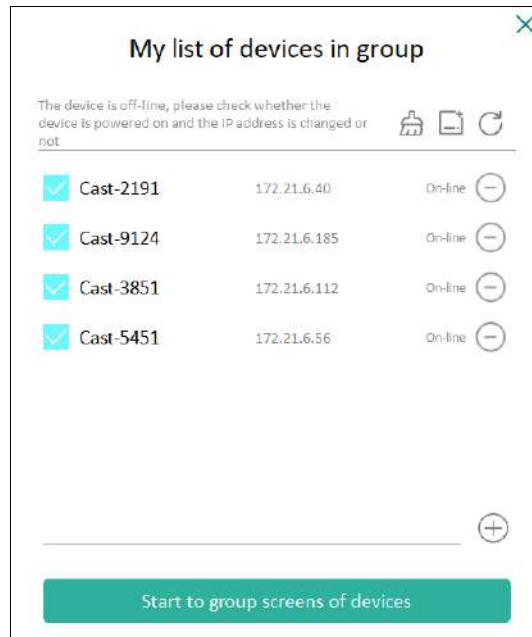

Synchronized Group Screen All the Time

When the “Synchronized group screen all the time” function is toggled ON, it will display a synchronized group screen continuously. If it is toggled OFF, it will work on vCast mirroring only.

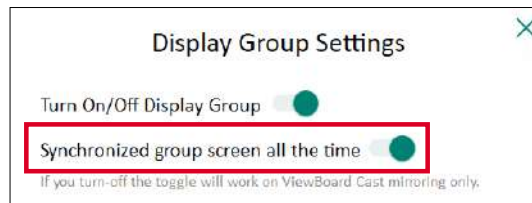

NOTE: Select the devices to group first, then toggle the “Synchronized group screen all the time” function ON to avoid interruption.

Share a Screen to the Display Group (One to Many Casting)

After confirming the above settings, you can share your screen to the main display, then the grouped client devices will be synced up to your screen.



Moderator Mode

Moderator Mode allows the moderator to take control of the devices connected to the ViewBoard or display. To enter Moderator Mode, select the Moderator Mode icon (👤) located in the lower-right corner of the screen.

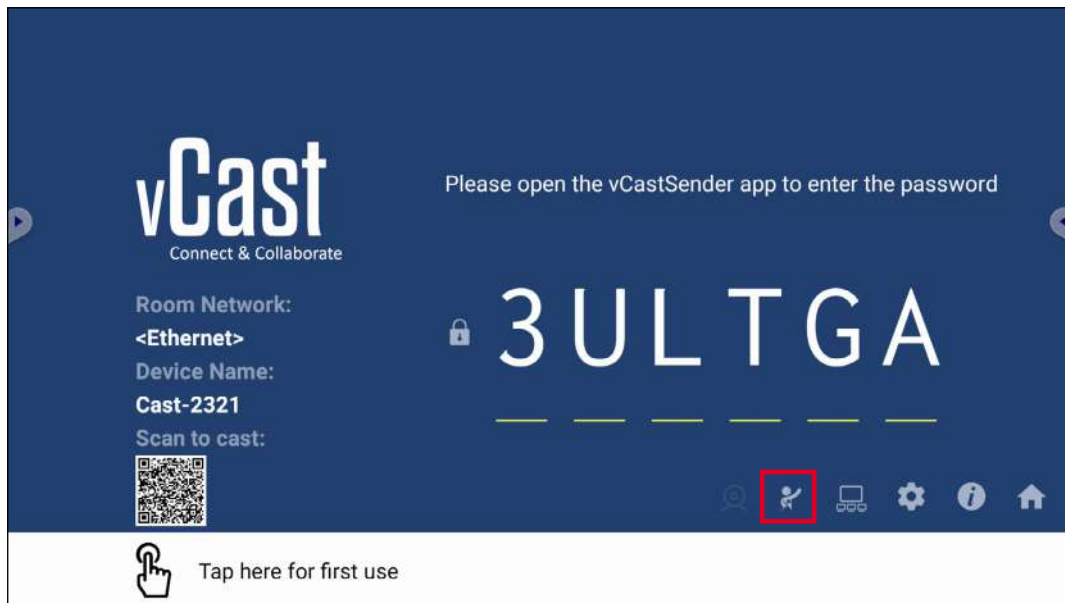

When enabled, the moderator can view a list of all connected screens in the left floating window and can preview each participant's screen and then select any of participant's screen and cast to the ViewBoard's or display's main screen for presentation. The moderator can also control each participant's screen, annotate on the ViewBoard or display, and remove unwanted participants by selecting the close icon (X).



Broadcast

When enabled, the ViewBoard's screen will be broadcasted to all of the participant's connected screens simultaneously. The participants can only view the presentation contents until the moderator disables the Broadcast function.



Multiple Screen Sharing

By default, vCast is set to allow multiple screen sharing, but can also be set to single screen sharing. To do this, the moderator can select the Multiple Screen Sharing icon to switch to single screen sharing.

Preview Screen

By default, vCast is set to let the moderator preview the participant's screen contents prior to sharing to the ViewBoard. Selecting the Preview Screen icon, the Moderator can switch to see the participant's name only.

Touch

By default, participants can use touch for collaboration after connecting. The moderator can enable/disable the touch function of a participant by selecting the Touch icon in their window.

NOTE:

- Moderator Mode is supported on all vCastSender and AirPlay devices, but mobile devices are limited to a "preview" function. Additionally, mobile Android devices cannot cast sound out.
- When you cast your Windows/Mac/Chrome screen to a ViewBoard or display, the selected full screen unit will not be broadcasted back to your device to avoid repetitive screen casting.
- The active presenter can touch each of the participant's screens to remotely control casting devices.
- The number of multi-screen presenters on-screen depends on your Windows CPU processor performance and router specifications.

Casting from Windows, MacBook, and Chrome Devices

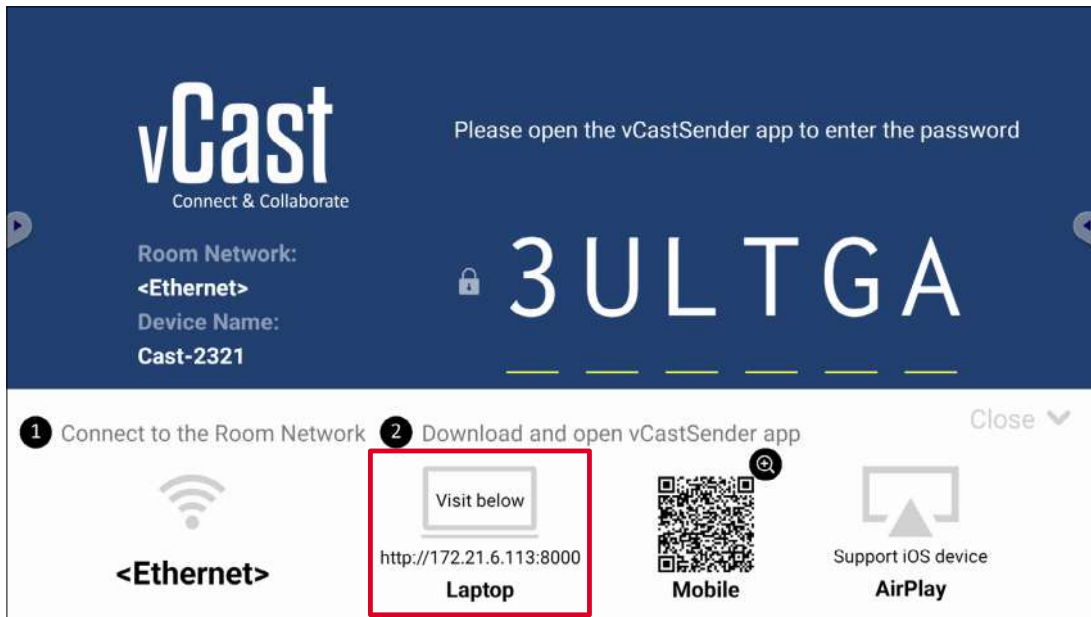

1. Ensure the client device (e.g., laptop) is connected to the same network as the ViewBoard.

NOTE: The network name can be found under **Room Network**.

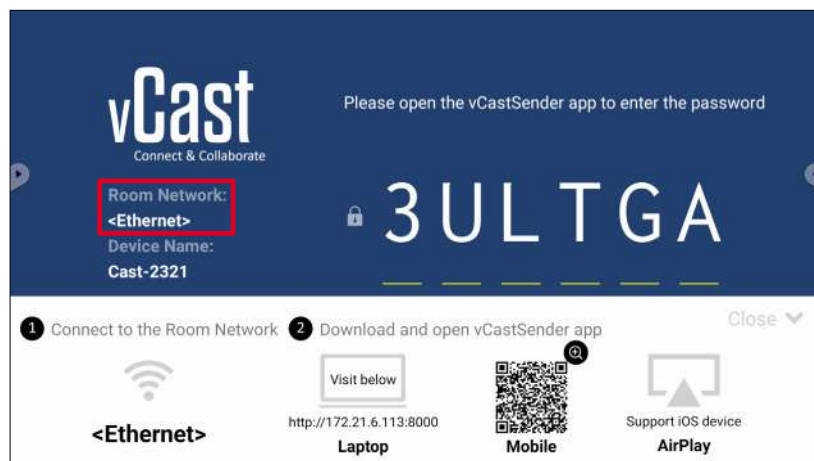

2. On the client device, visit the address that is shown on the ViewBoard to download and install the vCastSender application.
3. After installing, launch the vCastSender application.

4. To connect to the ViewBoard, input the PIN code and click OK.

NOTE: The **PIN code** can be found as highlighted below:

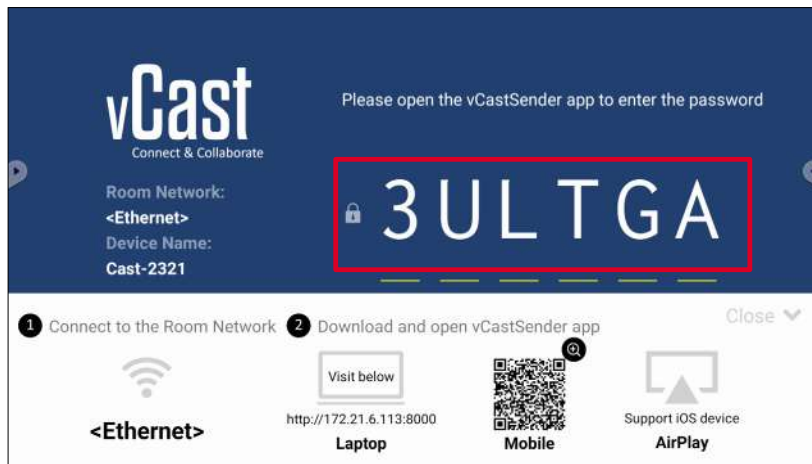

5. Additionally, you can connect to the ViewBoard by clicking **Device List** then the **Device Name** listed.

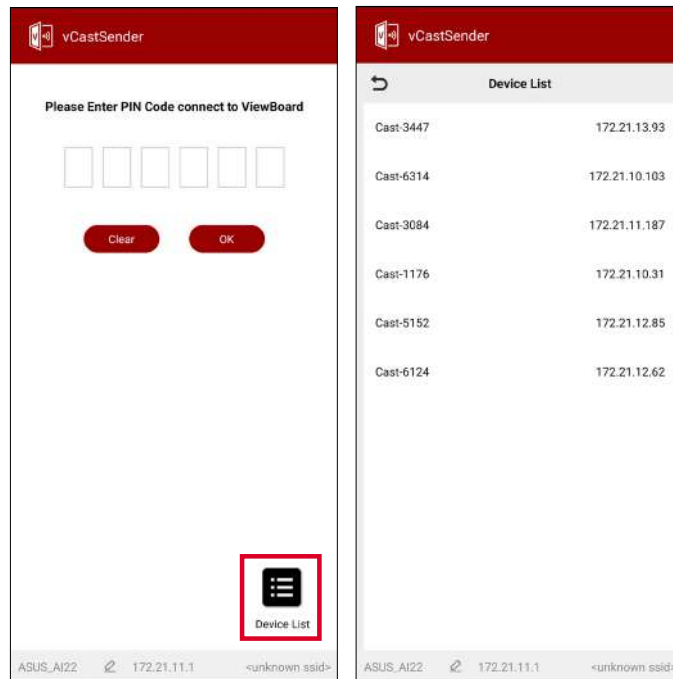

NOTE: The **Device Name** can be found as highlighted below:

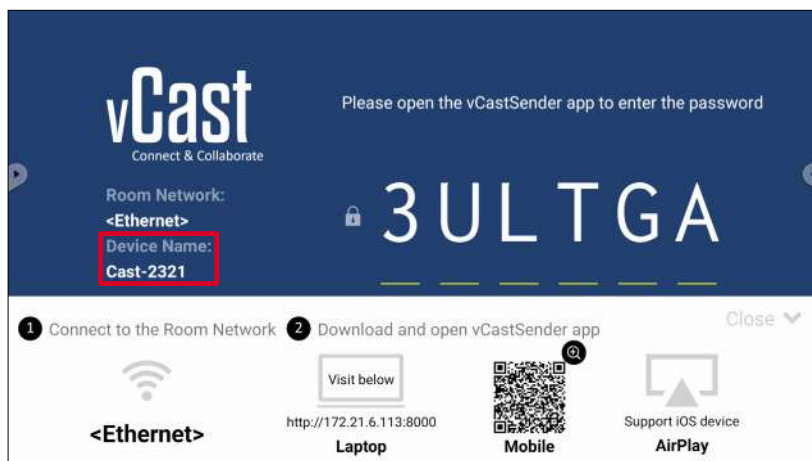

Casting from Android Devices

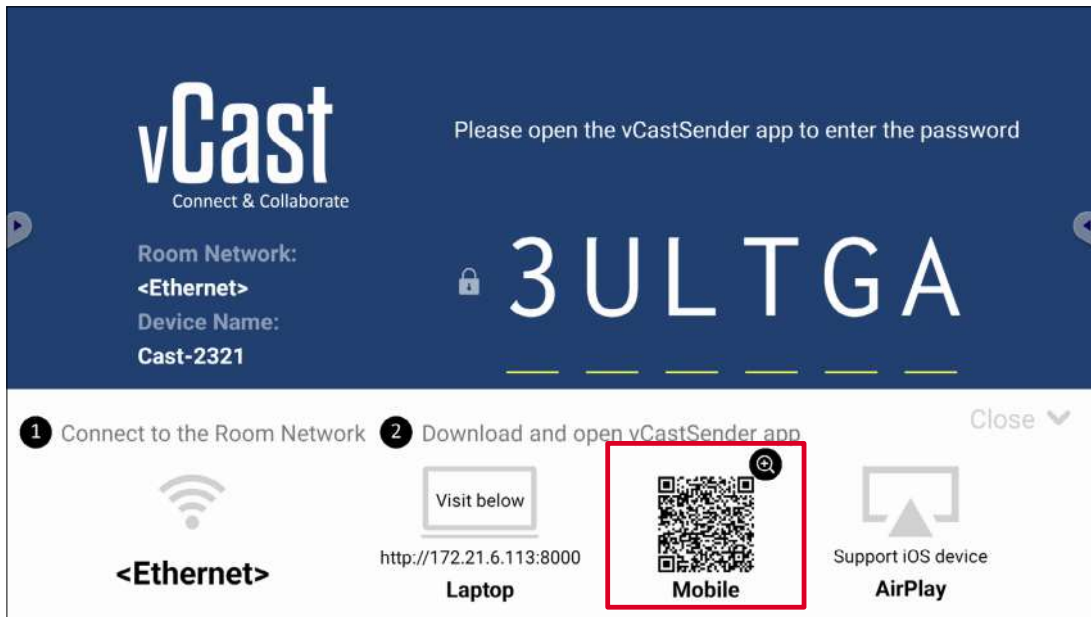

1. Ensure the client device (e.g., Android phone or tablet) is connected to the same network as the ViewBoard.

NOTE: The network name can be found under **Room Network**.

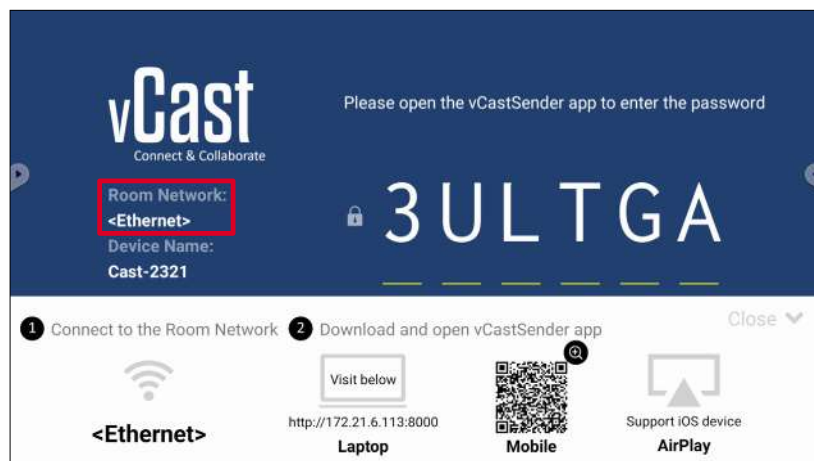

2. On the Android client device, scan the QR code shown on the ViewBoard to directly download the vCastSender application, or download the application from the Google Play Store.

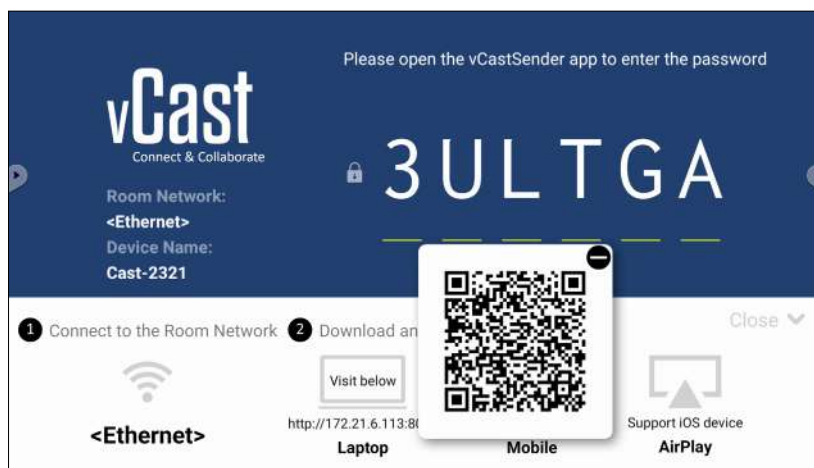

3. After installing, launch the vCastSender application.
4. To connect to the ViewBoard, input the PIN code and select **OK**.

NOTE: The **PIN code** can be found as highlighted below:

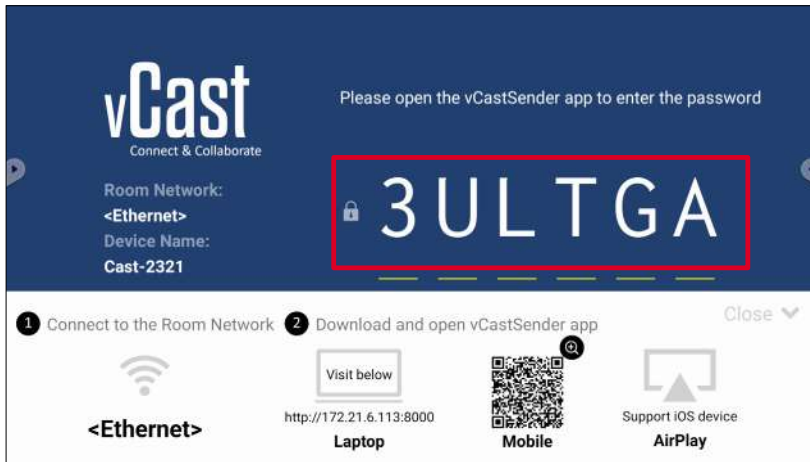

5. You can also connect to the ViewBoard by selecting **Device List** then the **Device Name** listed.

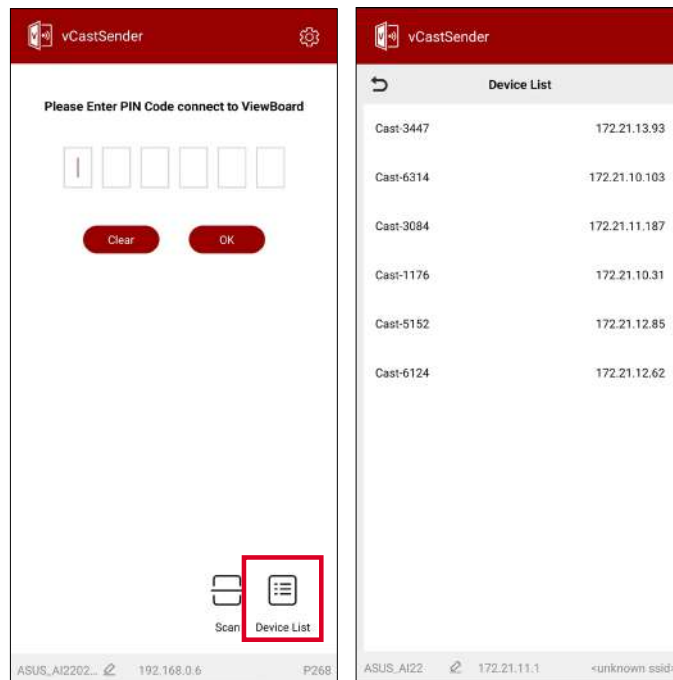

NOTE: The **Device Name** can be found as highlighted below:

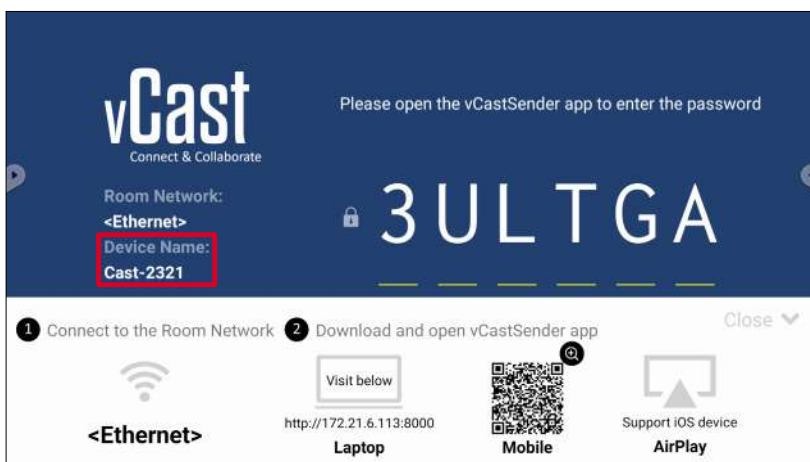

6. Additionally, you can connect to the ViewBoard or by selecting **Scan** then placing the on-screen QR code into the box to automatically connect.

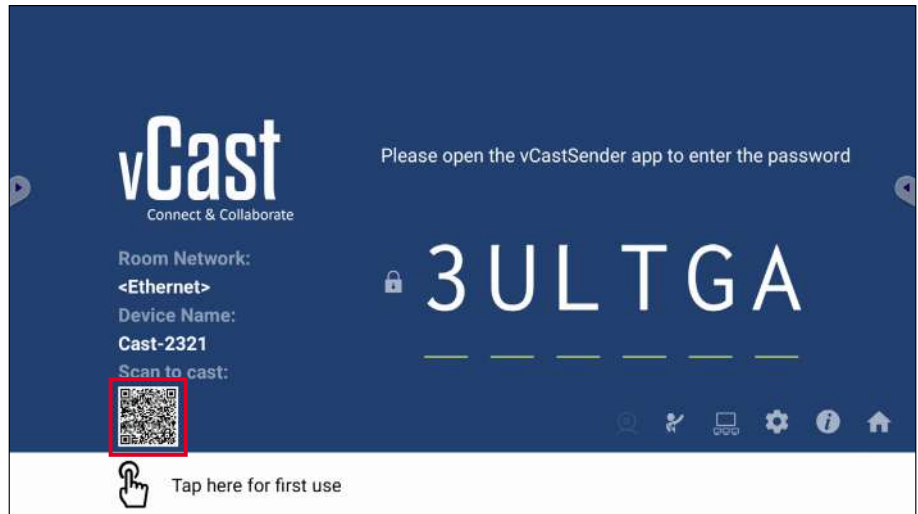
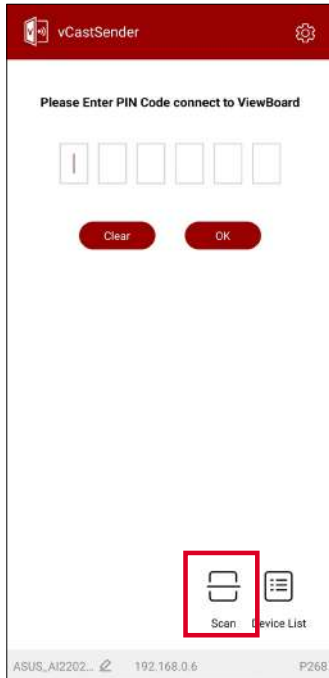

Casting from Apple iOS Devices

Apple AirPlay® is compatible with vCast for screen mirroring and content streaming under the same subnet environment only. An “AirPlay Password” will be generated on-screen for connection when using AirPlay to cast to a ViewBoard.

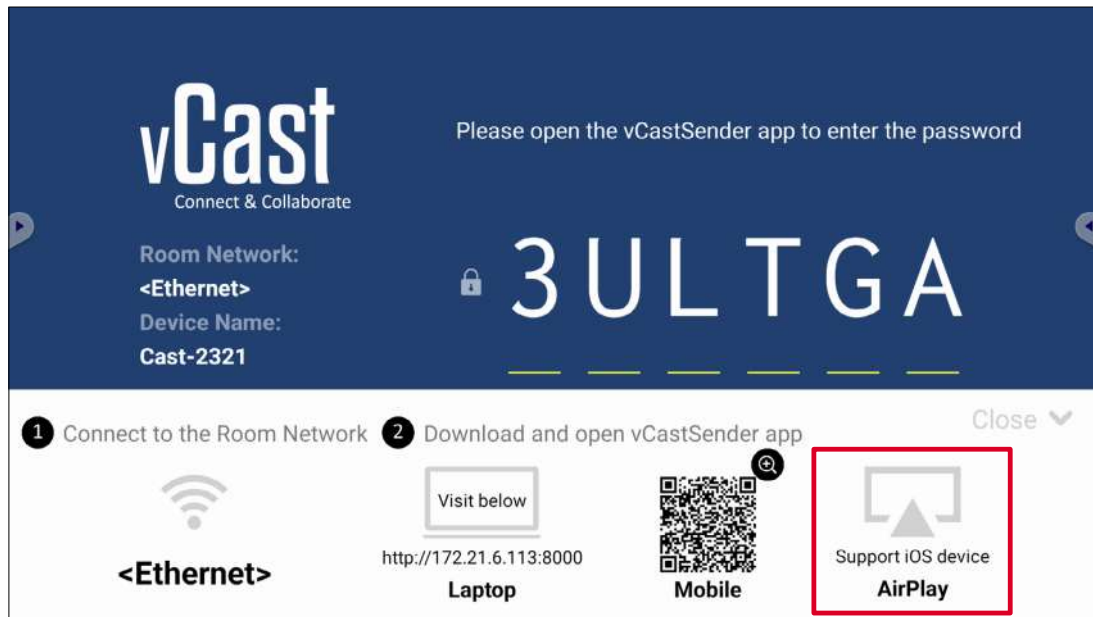

1. Ensure the client device (e.g., iPhone or iPad) is connected to the same network as the ViewBoard.

NOTE: The network name can be found under **Room Network**.

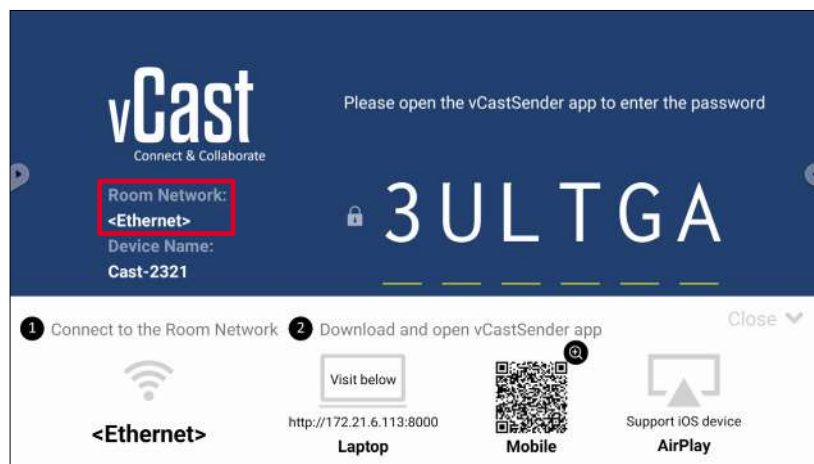

2. On the iOS client device, directly open AirPlay and select the **Device Name** of the ViewBoard to connect.

NOTE: The **Device Name** can be found as highlighted below:

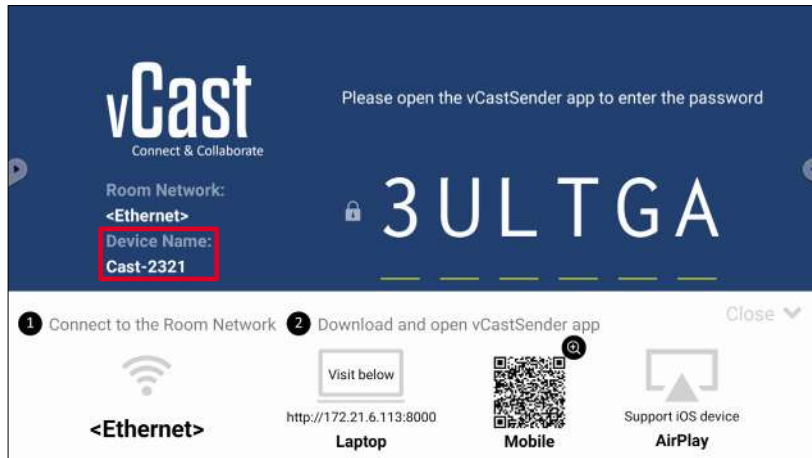

3. Input the generated on-screen **AirPlay Password** on the client device to connect.

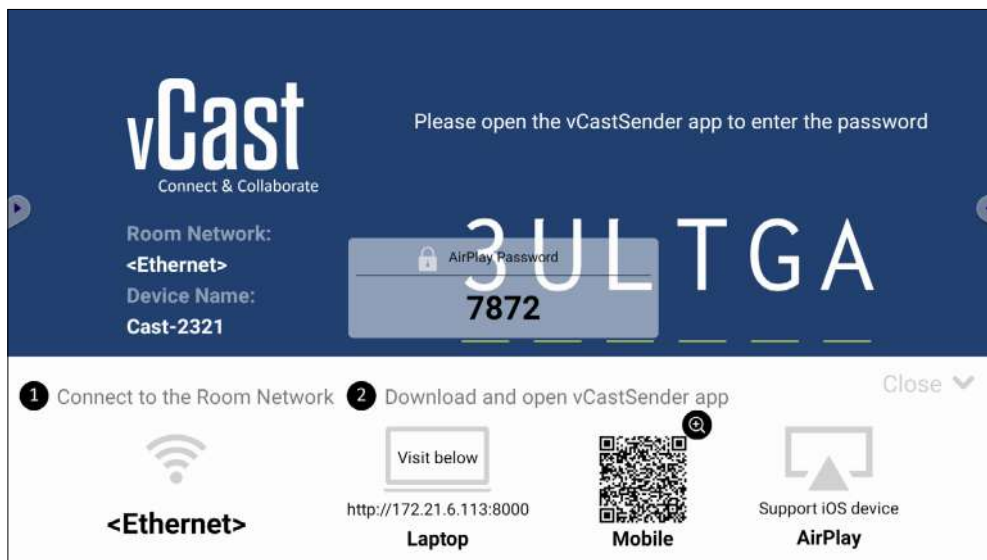

NOTE: In a cross subnet environment, please download and connect with the vCastSender iOS application from the Apple App Store.



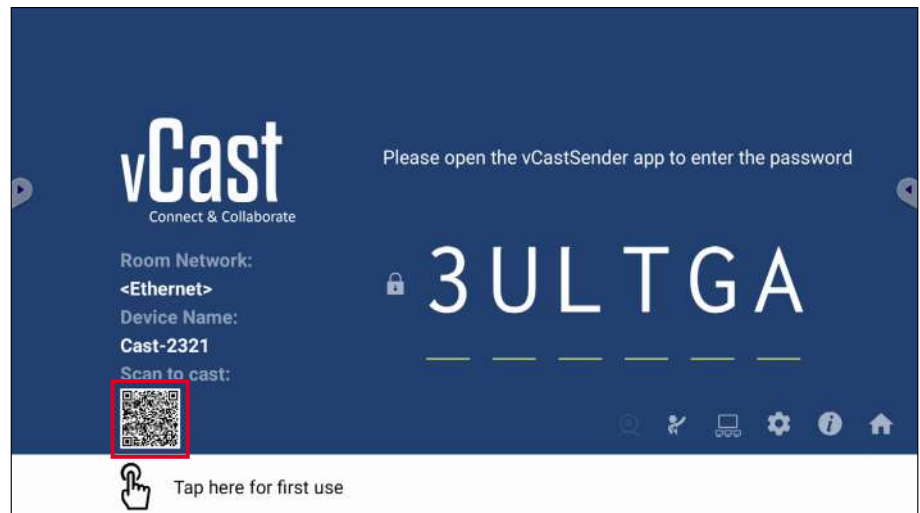
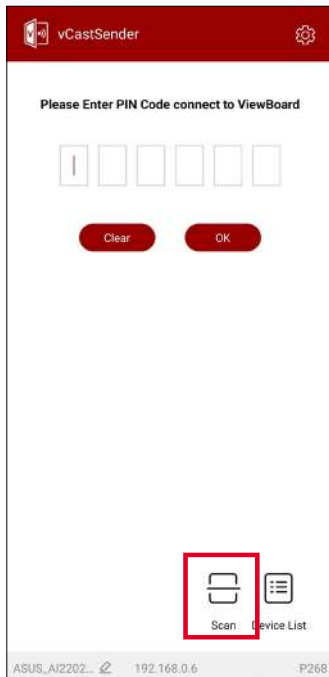



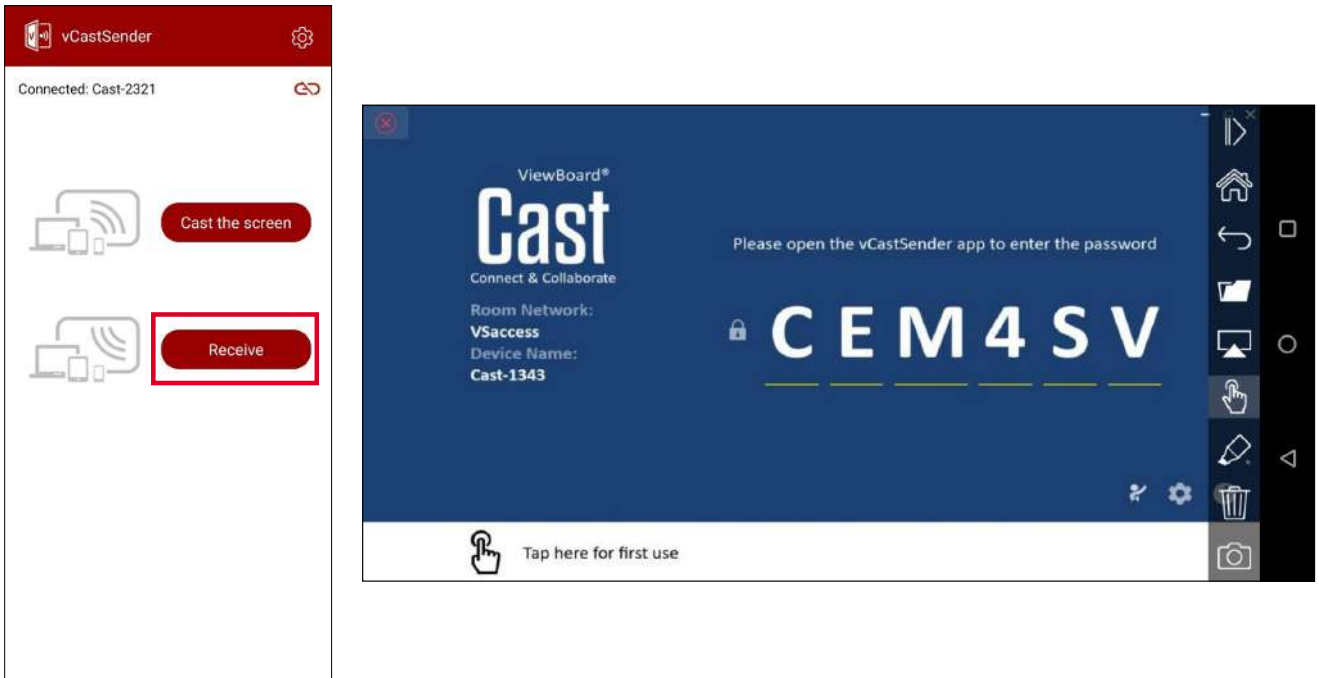

4. You can also connect to the ViewBoard by selecting **Scan** then placing the on-screen QR code into the box to automatically connect.



Connecting to a ViewBoard from a Mobile Device

Once connected, select **Receive**. The ViewBoard will appear on the mobile device with an on-screen toolbar. Users can interact with the ViewBoard with annotations, file sharing, etc.



Item		Description
	Toggle	Hide or display the toolbar.
	Home	Return to the Home interface.
	Return	Return to the previous operation.
	Folder	View or open the mobile device's files.
	Share	Cast the mobile device's screen to the connected ViewBoard or display.
	Touch	Remotely control the connected ViewBoard or display.
	Annotate	Make annotations, and adjust the pen color.
	Clear	Clear everything on screen.
	Camera	Send camera images to the connected ViewBoard or display.

Other Default Applications

Browser

Web browser for surfing the Internet.

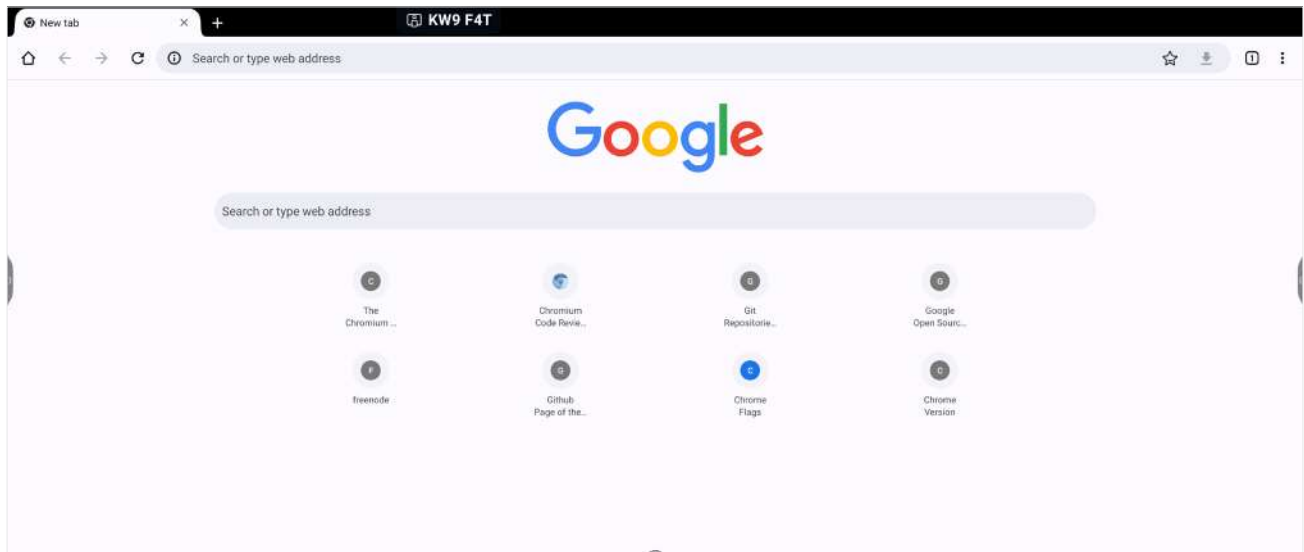

Finder



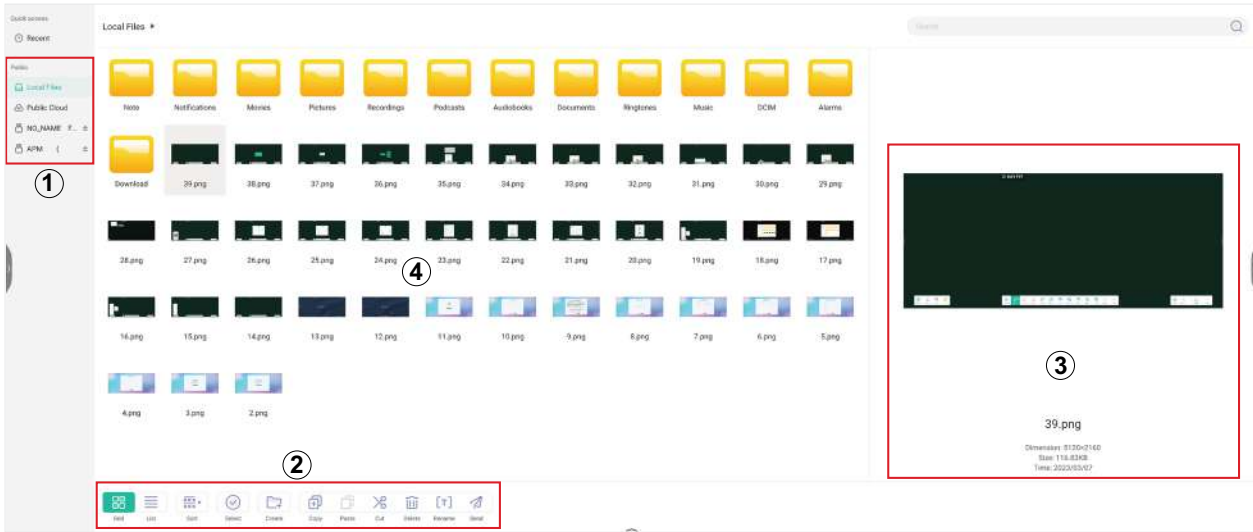







Manage files and folders.



1. Storage Device Display

Select the appropriate storage device.

2. Icons

	Item	Description
	Grid	Display files by grid
	List	Display files by list
	Sort	Sort the files
	Select	Select a file
	Create	Create a new folder
	Copy	Copy a file
	Paste	Paste a copied or cut file
	Cut	Cut a file
	Delete	Delete a file
	Rename	Rename a file
	Send	Share a file

3. File Information

Preview the file, show the file's name, size, resolution, and creation date.

4. Main Display Area

Files are displayed here.

OfficeSuite

Create, edit, and view documents, spreadsheets, presentations, and PDFs.

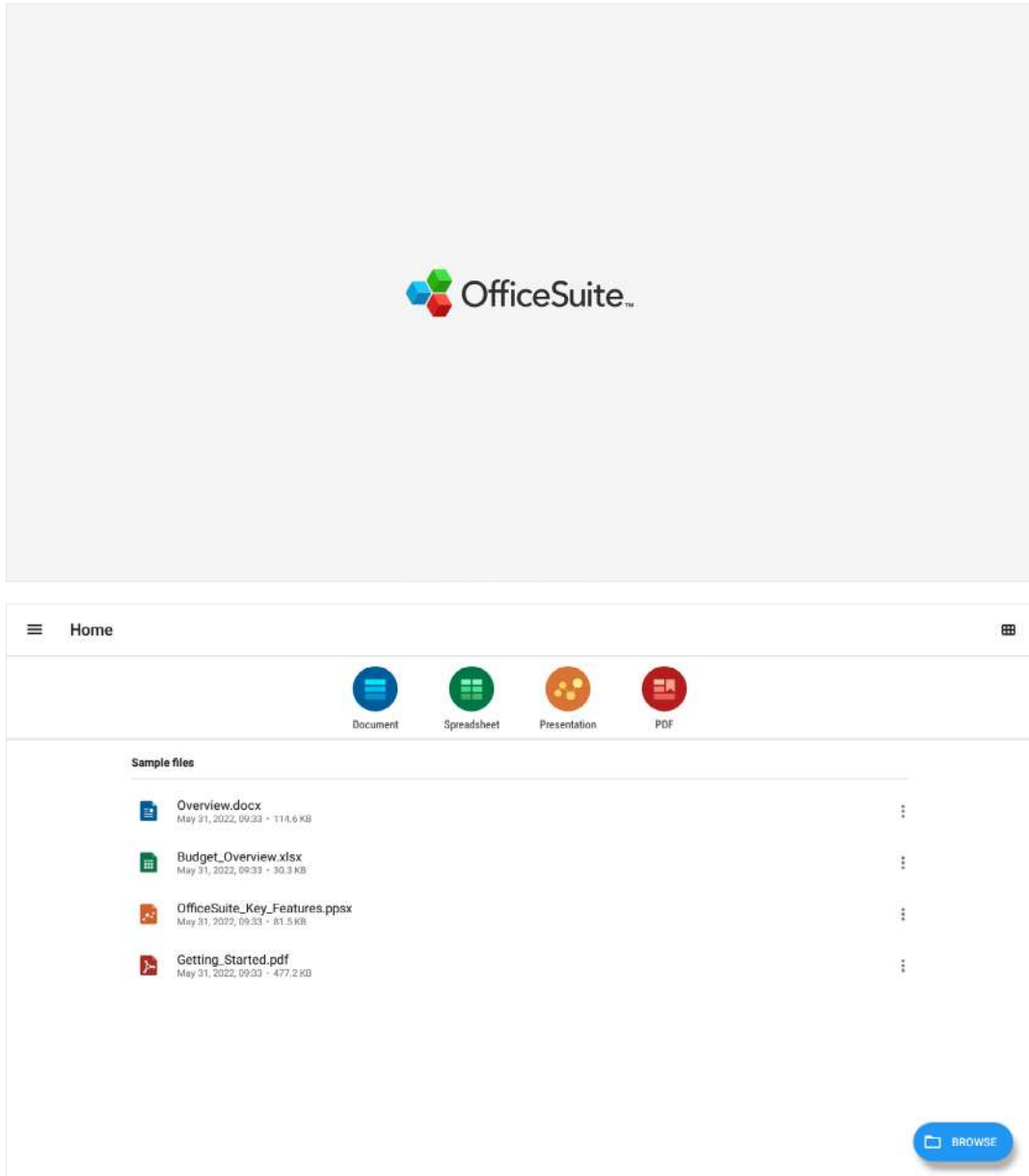

PIP (Picture-in-Picture)

Split the screen into two parts, a main window and an inset window.

NOTE: PIP only works between an Android application (browser, media player, vCast) and an external source.

- To open PIP, select: **All Apps > PIP**.

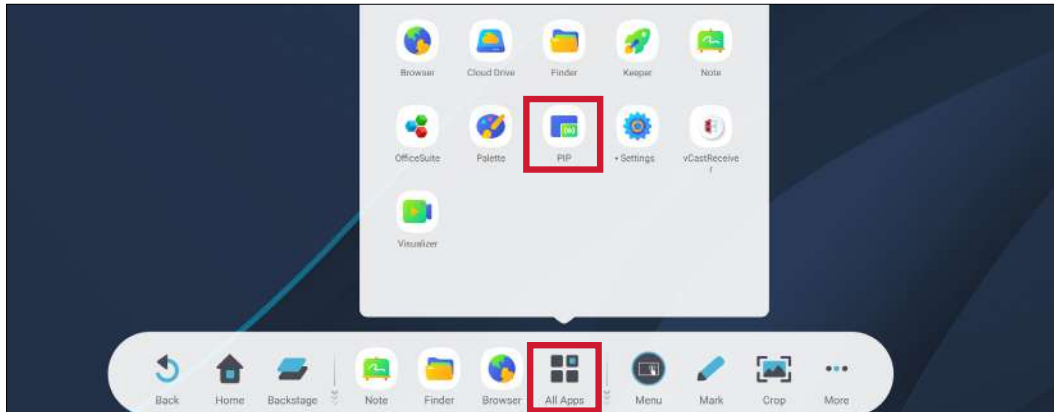

- To change the position of the inset window, select, hold and drag the window to the preferred location.

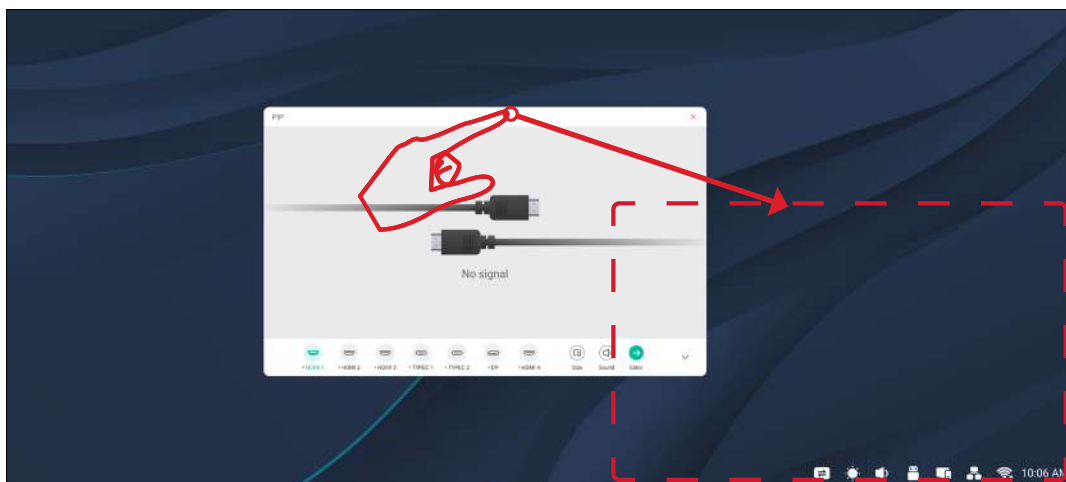

- To adjust the size of the inset window, select **Size**.

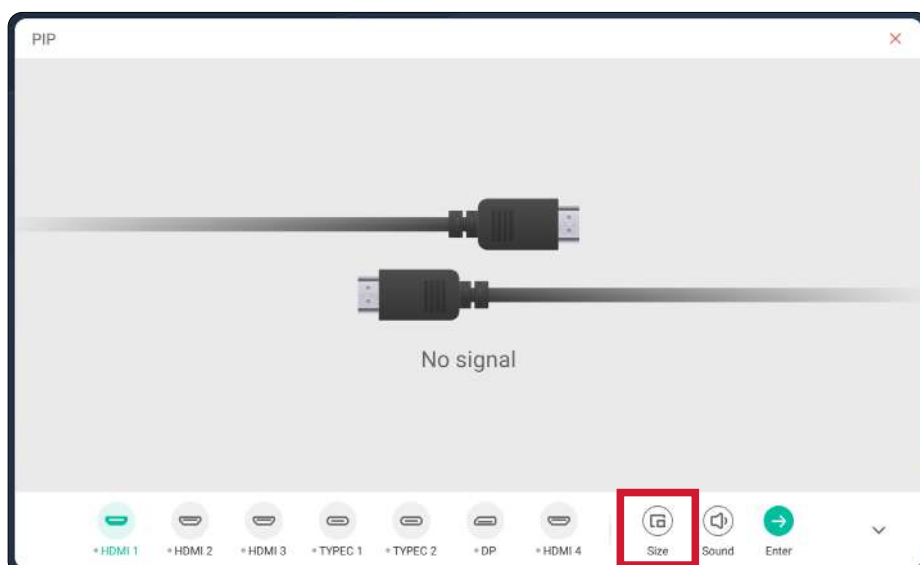

- To change PIP input source select **HDMI 1, HDMI 2, HDMI 3, HDMI 4, Type C 1, Type C 2, or DP.**

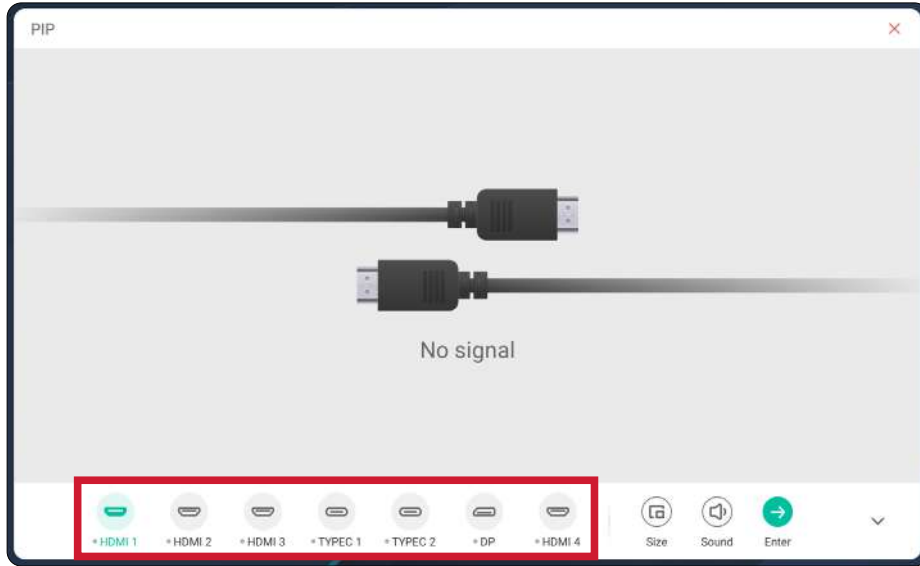

- To control the connected external device's volume, select **Sound.**

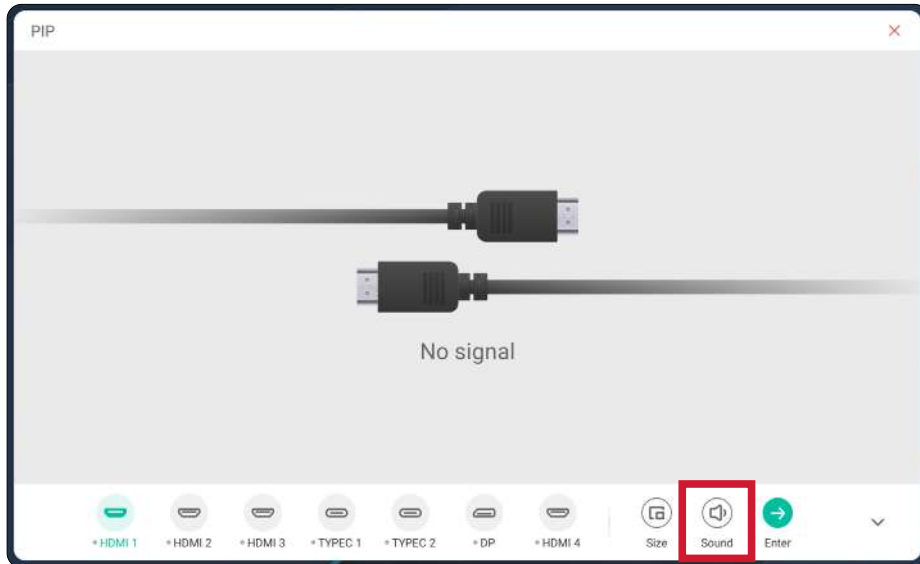

- Select **Enter** to switch to the PIP input source.

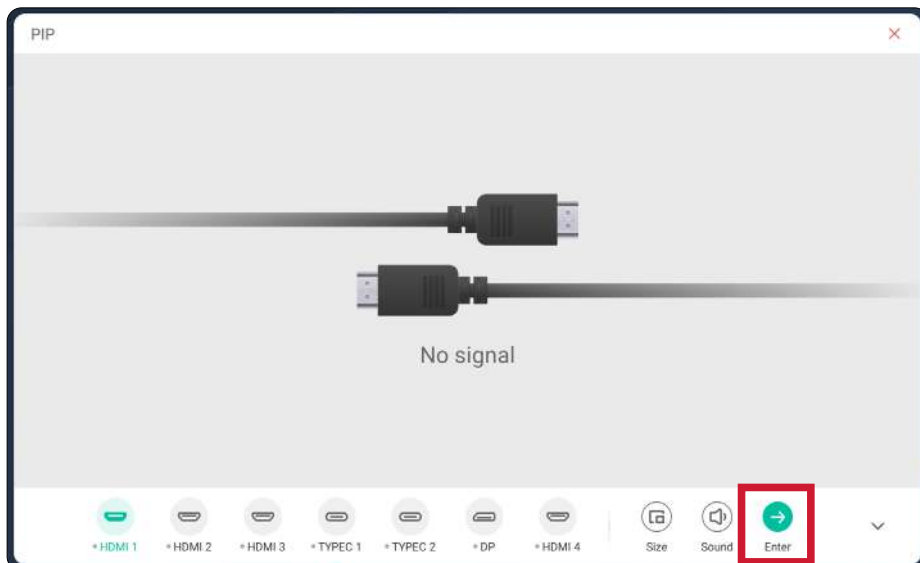

RS-232 Protocol

This document describes the hardware interface spec and software protocols of RS-232 interface communication between ViewSonic LFD and PC or other control units with RS-232 protocol.

The protocol contains three command sections:

- Set-Function
- Get-Function
- Remote control pass-through mode

NOTE: Below, “PC” represents all the control units that can send or receive the RS-232 protocol command.

Description

RS-232 Hardware Specification

ViewSonic LFD communication port on the rear side:

1. Connector type: DSUB 9-Pin Male (or 3.5 mm barrel connector)
2. Use of crossover (null modem) cable for connection
3. Pin Assignment:

Female DSUB 9-Pin

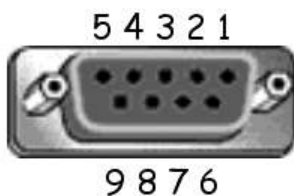

Male DSUB 9-Pin

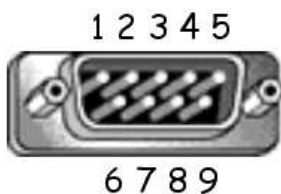

3.5 mm barrel connector (alternative for limited space)



Pin #	Signal	Remark
1	NC	
2	RXD	Input to Display
3	TXD	Output from Display
4	NC	
5	GND	
6	NC	
7	NC	
8	NC	
9	NC	Provide +5V/2A power for external specific dongle *3.0
frame	GND	

Item	Signal	Remark
Tip	TXD	Output from Display
Ring	RXD	Input to Display
Sleeve	GND	

LAN Hardware Specification

ViewSonic LFD communication port on the rear side:

1. Connector type: 8P8C RJ45
2. Pin Assignment:

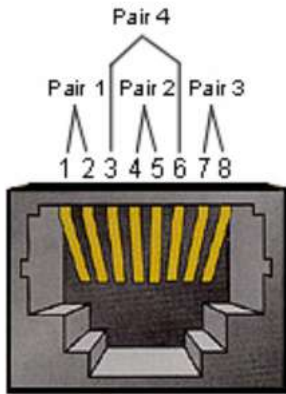

Pin #	Signal	Remark
1	TX+	Output from Display
2	TX-	Output from Display
3	RX+	Input to Display
4	BI_D3+	For 1G case
5	BI_D3-	For 1G case
6	RX-	Input to Display
7	BI_D4+	For 1G case
8	BI_D4-	For 1G case
frame	GND	

RS232 Communication Setting

- Baud Rate Select: 9600bps (fixed)
- Data bits: 8 bits (fixed)
- Parity: None (fixed)
- Stop Bits: 1(fixed)

LAN Communication Setting

- Type: Ethernet
- Protocol: TCP/IP
- Port: 5000 (fixed)
- Cross subnet: No
- Logon Credentials: No

Command Message Reference

PC sends to LFD command packet followed by “CR”. Every time PC sends control command to Display, the Display shall respond as follows:

1. If the message is received correctly it will send “+” (02Bh) followed by “CR” (00Dh)
2. If the message is received incorrectly it will send “-” (02Dh) followed by “CR” (00Dh)

Protocol

Set-Function Listing

The PC can control the Display for specific actions. The Set-Function command allows you to control the Display behavior at a remote site through the RS-232 port. The Set-Function packet format consists of 9 bytes.

Set-Function Description:

- Length:** Total Byte of Message excluding "CR"
- LFD ID** Identification for each of Display (01~98; default is 01)
ID "99" means to apply the set command for all connected displays. Under such circumstances, only ID#1 display has to reply.
The LFD ID can be set via the OSD menu for each Display.
- Command Type** Identify command type,
"s" (0x73h): Set Command
"+" (0x2Bh): Valid command Reply
"- " (0x2Dh): Invalid command Reply
- Command:** Function command code: One byte ASCII code.
- Value[1~3]:** Three bytes ASCII that defines the value.
- CR** 0x0D

Set-Function Format

Send: (Command Type="s")

Name	Length	ID	Command Type	Command	Value1	Value2	Value3	CR
Byte Count	1 Byte	2 Byte	1 Byte	1 Byte	1 Byte	1 Byte	1 Byte	1 Byte
Bytes order	1	2~3	4	5	6	7	8	9

Reply: (Command Type="+" or "-")

Name	Length	ID	Command Type	CR
Byte Count	1 Byte	2 Byte	1 Byte	1 Byte
Bytes order	1	2~3	4	5

NOTE: When PC applies command to all displays (ID=99), only the #1 set needs to reply by the name of ID=1.

Example 1: Set Brightness as 76 for Display (#02) and this command is valid

Send (Hex Format)

Name	Length	ID	Command Type	Command	Value1	Value2	Value3	CR
Hex	0x38	0x30 0x32	0x73	0x24	0x30	0x37	0x36	0x0D

Reply (Hex Format)

Name	Length	ID	Command Type	CR
Hex	0x34	0x30 0x32	0x2B	0x0D

Example 2: Set Brightness as 75 for Display (#02) and this command is NOT valid

Send (Hex Format)

Name	Length	ID	Command Type	Command	Value1	Value2	Value3	CR
Hex	0x38	0x30 0x32	0x73	0x24	0x30	0x37	0x35	0x0D

Reply (Hex Format)

Name	Length	ID	Command Type	CR
Hex	0x34	0x30 0x32	0x2D	0x0D

Set-Function Table

A. Basic Function

Set Function	Length	ID	Command		Value Range (Three ASCII bytes)	Comments	
			Type (ASCII)	Code (ASCII) Code (Hex)			
Power on/ off (standby)	8		s	!	21	000: STBY 001: ON	<ol style="list-style-type: none"> The Power-on via LAN control may work only under specific mode. To see display UG for details. *3.1.1 “WOL by MAC address” may available as alternative.*3.2.1
Input Select	8		s	“	22	000: TV 001: AV 002: S-Video 003: YPbPr 004: HDMI1 014: HDMI2 024: HDMI3 034: HDMI4 005: DVI 006: VGA1 016: VGA2 026: VGA3 007: Slot-in PC (OPS/SDM)/HDBT 008: Internal memory 009: DP 00A: Embedded/ Main (Android)	<ol style="list-style-type: none"> No need for USB For the case of two more same sources, the 2nd digital is used to indicate the extension. The HEX of 00A is 30 30 41.
Brightness	8		s	\$	24	000 ~ 100 900: Bright down (-1) 901: Bright up (+1) *3.1.1	
Backlight*3.2.0	8		A	B	42	000 ~ 100	<ol style="list-style-type: none"> For Android platform whose main mode is controlled by backlight and the other sources are controlled by brightness. Derived from Color calibration. *3.2.0
Power lock	8		s	4	34	000: Unlock 001: Lock	*See note in details
Volume	8		s	5	35	000 ~ 100 900: Volume down(-1) 901:Volume up(+1)	
Mute	8		s	6	36	000: OFF 001: ON (mute)	

Button lock	8		s	8	38	000: Unlock 001: Lock	*See note in details
Menu lock	8		s	>	3E	000: Unlock 001: Lock	*See note in details
Number *3.1.1	8		s	@	40	000~009	
Key Pad *3.1.1	8		s	A	41	000: UP 001: DOWN 002: LEFT 003: RIGHT 004: ENTER 005: INPUT 006: MENU/(EXIT) 007: EXIT	
Remote Control	8		s	B	42	000: Disable 001: Enable 002: Pass through	Disable: RCU will be no function Enabled: RCU controls normally Pass through: Display will bypass the RC code to connected device via the RS232 port, but not react itself.
Restore default	8		s	~	7E	000	Recover to factory setting

NOTE:

1. Behavior at Lock Modes

Lock Mode	Behavior
Button Lock	<ol style="list-style-type: none"> 1. Lock all buttons on the front panel and RCU, except for "Power" 2. All the SET functions should be workable via RS-232, even the ones with according hot key in RCU like Mute,...etc.
MENU Lock	<ol style="list-style-type: none"> 1. Lock "MENU" key of front panel and RCU 2. The Factory and Hospitality modes should not be blocked for the model using MENU-combined key to enter these two modes. Alternative approach will be indicated separately if any limitation by model.
POWER Lock	<ol style="list-style-type: none"> 1. Lock "POWER" key on the front and RCU. 2. The SET_POWER on/off should be workable via RS-232, but does not mean the POWER lock will be released under this case. 3. Can not be unlocked by reset in OSD setting 4. Will auto AC power-on in power-lock 5. Under power-lock, the set will not enter power saving when no PC signal and neither not turn off when no other video signals after 15 minutes.
Remote control disable	Lock the RCU keys, but keep the front panel buttons workable.

2. Wake-on-LAN by MAC address as alternative for SET Power on

(Length=126 Bytes)

6 Bytes	6 Bytes (#1)	6 Bytes (#2)	...	6 Bytes (#16)	24 Bytes
0xFF FF ... FF	MAC address	MAC address	...	MAC address	0x00 00 ... 00

B. Optional Function

Set Function	Length	ID	Command		Value Range (Three ASCII bytes)	Comments
			Type (ASCII)	Code (ASCII) Code (Hex)		
Contrast	8		s	# 23	000 ~ 100	
Sharpness	8		s	% 25	000 ~ 100	
Color	8		s	& 26	000 ~ 100	
Tint	8		s	' 27	000 ~ 100	
Backlight On_Off	8		s	(29	000: Off 001: On	
Color mode	8		s) 29	000: Normal 001: Warm 002: Cold 003: Personal	
Surround sound	8		s	- 2D	000: OFF 001: ON	
Bass	8		s	. 2E	000 ~ 100	
Treble	8		s	/ 2F	000 ~ 100	
Balance	8		s	0 30	000 ~ 100	050 is central
Picture Size	8		s	1 31	000: FULL (16:9) 001: NORMAL (4:3) 002: REAL (1:1) *3.1.0	
OSD language	8		s	2 32	000: English 001: French 002: Spanish	Could be extended for more supported languages by model
PIP-Mode	8		s	9 39	000: OFF 001: PIP(POP) 002: PBP	
PIP-Sound select	8		s	: 3A	000: Main 001: Sub	
PIP-Position	8		s	; 3B	000: Up 001: Down 002: Left 003: Right	
PIP-Input	8		s	7 37 *2.9	000: TV 001: AV 002: S-Video 003: YPbPr 004: HDMI1 014: HDMI2 024: HDMI3 034: HDMI4 005: DVI 006: VGA1 016: VGA2 026: VGA3 007: Slot-in PC (OPS/SDM)/HDBT 008: Internal memory 009: DP 00A: Embedded/Main (Android)	Value range is same as SET-Input select

Tiling-Mode	8		s	P	50	000: OFF 001: ON	(for video wall)
Tiling-Compensation	8		s	Q	51	000: OFF 001: ON	(for video wall) Bezel width compensation
Tiling-H by V Monitors	8		s	R	52	01x~09x: H 0x1~0x9: V	(for video wall) 1. 2nd digital for H monitors 2. 3rd digital for V monitors
Tiling-Position	8		s	S	53	001~025	(for Video wall) Copy the screen of Position# to identified display
Date: Year	8		s	V	56	Y17~Y99	Last 2 digits (20)17~(20)99
Date: Month	8		s	V	56	M01~M12	2 digits
Date: Day	8		s	V	56	D01~D31	2 digits
Time: Hour	8		s	W	57	H00~H23	24-hr format. 2 digits.
Time: Min	8		s	W	57	M00~M59	2 digits
Time: Sec	8		s	W	57	S00~S59	2 digits

NOTE:

1. Tiling definition of H Monitors, V Monitors, and Position

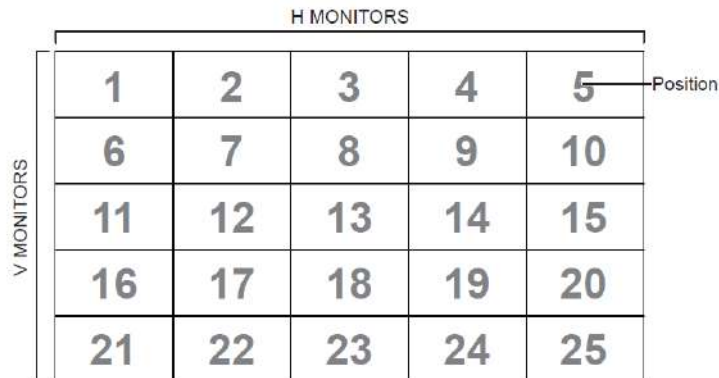

2. Set Date example

Date: 2017-3/15

Send: 0x 38 30 31 73 56 59 31 37 0D ("Y17")

Send: 0x 38 30 31 73 56 4D 30 33 0D ("M03")

Send: 0x 38 30 31 73 56 44 31 35 0D ("D15")

3. Set Time example

Time: 16:27:59

Send: 0x 38 30 31 73 57 48 31 36 0D ("H16")

Send: 0x 38 30 31 73 57 4D 32 37 0D ("M27")

Send: 0x 38 30 31 73 57 53 35 39 0D ("S59")

Get-Function Listing

The PC can interrogate the LFD for specific information. The Get-Function packet format consists of 9 bytes which is similar to the Set-Function packet structure. Note that the “Value” byte is always = 000.

Get-Function Description:

- Length:** Total Byte of Message excluding “CR”.
- TV/DS ID** Identification for each of TV/DS (01~98; default is 01).
- Command Type** Identify command type,
 “g” (0x67h) : Get Command
 “r” (0x72h) : Valid command Reply
 “-” (0x2Dh) : Invalid command Reply
- Command:** Function command code: One byte ASCII code.
- Value[1~3]:** Three bytes ASCII that defines the value.
- CR** 0x0D

Get-Function Format

Send: (Command Type=“g”)

Name	Length	ID	Command Type	Command	Value1	Value2	Value3	CR
Byte Count	1 Byte	2 Byte	1 Byte	1 Byte	1 Byte	1 Byte	1 Byte	1 Byte
Bytes order	1	2~3	4	5	6	7	8	9

Reply: (Command Type=“r” or “-”)

If the Command is valid, Command Type = “r”

Name	Length	ID	Command Type	Command	Value1	Value2	Value3	CR
Byte Count	1 Byte	2 Byte	1 Byte	1 Byte	1 Byte	1 Byte	1 Byte	1 Byte
Bytes order	1	2~3	4	5	6	7	8	9

If the Command is NOT valid, Command Type = “-”

Name	Length	ID	Command Type	CR
Byte Count	1 Byte	2 Byte	1 Byte	1 Byte
Bytes order	1	2~3	4	5

Example 1: Get Brightness from TV-05 and this command is valid. The Brightness value is 67.

Send (Hex Format)

Name	Length	ID	Command Type	Command	Value1	Value2	Value3	CR
Hex	0x38	0x30 0x35	0x67	0x62	0x30	0x30	0x30	0x0D

Reply (Hex Format)

Name	Length	ID	Command Type	Command	Value1	Value2	Value3	CR
Hex	0x38	0x30 0x35	0x72	0x62	0x30	0x36	0x37	0x0D

Example 2: Get Color from Display (#05), but the Color command is not supported by this model.

Send (Hex Format)

Name	Length	ID	Command Type	Command	Value1	Value2	Value3	CR
Hex	0x38	0x30 0x35	0x67	0x26	0x30	0x30	0x30	0x0D

Reply (Hex Format)

Name	Length	ID	Command Type	CR
Hex	0x34	0x30 0x35	0x2D	0x0D

Get-Function Table

A. Basic Function

Get Function	Length	ID	Command		Response Range (Three ASCII bytes)	Comments
			Type (ASCII)	Code (ASCII) Code (Hex)		
Get-Brightness	8		g	b 62	000 ~ 100	
Get-Backlight ^{*3.2.0}	8		a	B 42	000 ~ 100	1. For Android platform whose main mode is controlled by backlight and the other sources are controlled by brightness. 2. Derived from Color calibration. ^{*3.2.0}
Get-Volume	8		g	f 66	000 ~ 100	
Get-Mute	8		g	g 67	000: Off 001: On (muted)	
Get-Input select	8		g	j 6A	000~ 100~	1. 1st digit for signal detection: 0 means "no signal"; 1 means "signal detected" 2. 2nd & 3rd digit: See Set-function table
Get-Power status: ON/ STBY	8		g	l 6C	001: ON 000: STBY	
Get-Remote control	S		g	n 6E	000: Disable 001: Enable 002: Pass through	Get RCU mode status
Get-Power lock	8		g	o 6F	000: Unlock 001: Lock	
Get-Button lock	8		g	p 70	000: Unlock 001: Lock	
Get-Menu lock	8		g	l 6C	000: Unlock 001: Lock	
Get-ACK	8		g	z 7A	000	This command is used to test the communication link
Get-Thermal	8		g	0 30	000~100: 0~+100 deg C -01~-99: -1~-99 deg C	
Get-Operation time ^{*3.2.0}	8		g	1 31	000	1. Accumulated hours in 6-digit integer (000,001~999,999) ^{*3.2.0} 2. Can not be reset when FW update and Factory initiation ^{*3.2.2} 3. Reply in new 32-byte format ^{*3.2.0}
Get-Device name	8		g	4 34	000	Reply in new 32-byte format ^{*3.2.0}

Get-MAC address	8		g	5	35	000	(for the model with LAN) Reply in new 32-byte format*3.2.0
Get-IP address *3.2.0	8		g	6	36	000	(for the model with LAN) Reply in new 32-byte format*3.2.0
Get-Serial number *3.2.0	8		g	7	37	000	Reply in new 32-byte format *3.2.0
Get-FW version *3.2.0	8		g	8	38	000	Reply in new 32-byte format *3.2.0

NOTE:

1. Get Operation Hour example

Assumed the accumulated operation hour is 123,456 hrs

Send: 0x 38 30 31 67 31 30 30 30 0D (Get Operation hour)

Reply: 0x 32 30 31 72 31 31 32 33 34 35 36 00 00 ... 00 00 0D

2. Get Device Name example

Assumed the device name is CDE-5500

Send: 0x 38 30 31 67 34 30 30 30 0D (Get Device Name)

Reply: 0x 32 30 31 72 34 43 44 45 2D 35 35 30 30 00 00 ... 00 00 0D

Assumed the device name is "NMP-302#1"

Send: 0x 38 30 31 67 34 30 30 30 0D (Get Device Name)

Reply: 0x 32 30 31 72 34 4E 4D 50 2D 33 30 32 23 31 00 00 ...00 00 0D

3. Get MAC address example

Assumed the MAC address is 00:11:22:aa:bb:cc

Send: 0x 38 30 31 67 35 30 30 30 0D (Get MAC add)

Reply: 0x 32 30 31 72 35 30 30 31 31 32 32 61 61 62 62 63 63 00 00...00 00 0D

4. Get IP address example

Assumed the IP address is 192.168.100.2

Send: 0x 38 30 31 67 36 30 30 30 0D (Get IP address)

Reply: 0x 32 30 31 72 36 31 39 32 2E 31 36 38 2E 31 30 30 2E 32 00 00...00 00 0D

5. Get Serial number example

Assumed the Serial number is ABC180212345

Send: 0x 38 30 31 67 37 30 30 30 0D (Get Serial number)

Reply: 0x 32 30 31 72 37 41 42 43 31 38 30 32 31 32 33 34 35 00 00...00 00 0D

6. Get FW version example

Assumed the FW version is 3.02.001

Send: 0x 38 30 31 67 38 30 30 30 0D (Get FW version)

Reply: 0x 32 30 31 72 38 33 2E 30 32 2E 30 30 31 00 00...00 00 0D

B. Optional Function

Get Function	Length	ID	Command		Response Range	Comments
			Type (ASCII)	Code (ASCII) / Code (Hex)		
Get-Contrast	8		g	a / 61	000 ~ 100	
Get-Sharpness	8		g	c / 63	000 ~ 100	
Get-Color	8		g	d / 64	000 ~ 100	
Get-Tint	8		g	e / 65	000 ~ 100	
Get-Backlight On_Off	8		g	h / 68	000: Off 001: On	
Get-PIP mode	8		g	t / 74	000: OFF 001: PIP (POP) 002: PBP	
Get-PIP input	8		g	u / 75	000 ~	See Set-input select
Get-Tiling Mode	8		g	v / 76	000: OFF 001: ON	(for Video wall)
Get-Tiling Compensation	8		g	w / 77	000: OFF 001: ON	(for Video wall) Bezel width compensation
Get-Tiling H by V monitors	8		g	x / 78	01x~09x: H monitors 0x1~0x9: V monitors	(for Video wall) 1. 2nd digital for H monitors 2. 3rd digital for V monitors
Get-Tiling position	8		g	y / 79	000: OFF 001~025	(for Video wall) Copy the screen of Position# to identified display
Get-Date: Year	8		g	2 / 32	Y00~Y00	Last 2 digits (20)17~(20)99
Get-Date: Month	8		g	2 / 32	M00~M00	2 digits
Get-Date: Day	8		g	2 / 32	D00~M00	2 digits
Get-Time: Hour	8		g	3 / 33	H00~H00	24-hr format. 2 digits
Get-Time: Min	8		g	3 / 33	M00~M00	2 digits
Get-Time: Sec	8		g	3 / 33	S00~S00	2 digits

NOTE:

1. Get Date example

Assumed the current date of display#01 as below:

Date: 2017-3/15

Send: 0x 38 30 31 67 32 59 30 30 0D (Get Date:Year)

Reply: 0x 38 30 31 72 32 59 31 37 0D ("Y17")

Send: 0x 38 30 31 67 32 4D 30 30 0D (Get Date:Month)

Reply: 0x 38 30 31 72 32 4D 30 33 0D ("M03")

Send: 0x 38 30 31 67 32 44 30 30 0D (Get Date:Day)

Reply: 0x 38 30 31 72 32 44 31 35 0D ("D15")

2. Get Time example

Assumed the current time of display#01 as below:

Time: 16:27:59

Send: 0x 38 30 31 67 33 48 30 30 0D (Get Time:Hour)

Reply: 0x 38 30 31 72 33 48 31 36 0D ("H16")

Send: 0x 38 30 31 67 33 4D 30 30 0D (Get Time:Min)

Reply: 0x 38 30 31 72 33 4D 32 37 0D ("M27")

Send: 0x 38 30 31 67 33 53 30 30 0D (Get Time:Sec)

Reply: 0x 38 30 31 72 33 53 35 39 0D ("S59")

3. Get RS232 Version example

Assumed the version is 3.0.1

Send: 0x 38 30 31 67 36 30 30 30 0D (Get RS232 version)

Reply: 0x 38 30 31 72 36 33 30 31 0D ("301")

C. Auto Reply *3.2.1

The display will send out the updated data/status automatically without getting a query from the host whenever the following data/status is changed by the user through any of the available ways like: remote control unit, front keys, or touch screen.

- Power On/Off
- Input Select
- Brightness
- Backlight
- Volume
- Mute On/Off

Remote Control Pass-through Mode

When the PC sets the Display to Remote Control Pass through mode, the Display shall send a 7-byte packet (followed by “CR”) in response to remote control unit (RCU) button activation. In this mode the remote control shall have no effect on the Display function. For example: “Volume+” will not change the volume of the Display, but instead only sends the “Volume+” code to the PC over the RS-232 port.

IR Pass Through-Function format

Reply: (Command Type=“p”)

Name	Length	ID	Command Type	RCU Code1 (MSB)	RCU Code2 (LSB)	CR
Byte Count	1 Byte	2 Byte	1 Byte	1 Byte	1 Byte	1 Byte
Bytes order	1	2~3	4	5	6	7

Example 1: Remote Control Pass-through when “VOL+” key is pressed for Display (#5)

Send (Hex Format)

Name	Length	ID	Command Type	RCU Code1 (MSB)	RCU Code2 (LSB)	CR
Hex	0x36	0x30 0x35	0x70	0x31	0x30	0x0D

Key	Code (HEX)	Basic *3.1.1	Optional *3.1.1
1	01	V	
2	02	V	
3	03	V	
4	04	V	
5	05	V	
6	06	V	
7	07	V	
8	08	V	
9	09	V	
0	0A	V	
-	0B		V
RECALL (LAST)	0C		V
INFO (DISPLAY)	0D		V
	0E		
ASPECT (ZOOM, SIZE)	0F		V
VOLUME UP (+)	10	V	

VOLUME DOWN (-)	11	V	
MUTE	12	V	
CHANNEL/PAGE UP (+)/ BRIGHTNESS+	13		V
CHANNEL/PAGE DOWN (-)/ BRIGHTNESS-	14		V
POWER	15	V	
SOURCES (INPUTS)	16	V	
	17		
	18		
SLEEP	19		V
MENU	1A	V	
UP	1B	V	
DOWN	1C	V	
LEFT (-)	1D	V	
RIGHT (+)	1E	V	
OK (ENTER, SET)	1F	V	
EXIT	20	V	
	21		
	22		
	23		
	24		
	25		
	26		
	27		
	28		
	29		
	2A		
	2B		
RED ■ (F1)	2C		
GREEN ■ (F2)	2D		
YELLOW ■ (F3)	2E		
BLUE ■ (F4)	2F		

NOTE:

1. This IR-pass-through code is different from the RCU key code.
2. Special control sequence for POWER key under IR-pass through mode.
- 2-1. When Display is OFF and receives the IR POWER code: Display will turn itself on, then forward the POWER code to the host via RS-232.

- 2-2. When Display is ON and receives the IR POWER code: Display will forward the POWER code to the host via RS-232, then turn off itself.
- 2-3. When SET-POWER LOCK is enabled, the Display will not respond to POWER key pressing.
3. The VOLUME UP and VOLUME DOWN code will repeatedly output when you press and hold the keys.

Appendix

Specifications

Item	Category	Specifications
Model	P/N.	IFP105S
	No.	VS19390
Screen	Type	TFT LCD with DLED backlight WUHD 5120 x 2160, 0.1595 mm (H) x 0.4785 mm (V) pixel pitch
	Active Size	104.6" (2656.84 mm)
	Display Area (mm)	2465.92 (H) x 1049.56 mm (V)
	Display Area (in)	97.08" (H) x 41.32" (V)
	Surface Treatment	Anti-Glare (Haze 25%), Hard Coating (3H)
	Brightness	400 nits (Typical); 300 nits (Minimum)
Resolution	Recommended	3440 x 1440 @ 60Hz
	Supported	HDMI 2.1: 5120 x 2160 @ 60Hz HDMI 2.0: up to 3840 x 2160 @ 60Hz USB Type C: up to 3840 x 2160 @ 60Hz
Input Signal		<ul style="list-style-type: none"> • 1 x HDMI (v. 2.1) with HDMI CEC, HDCP 2.2 • 3 x HDMI (v. 2.0) with HDMI CEC, HDCP 2.2 • 1 x DP IN (v. 1.4) • 6 x USB Type A (3.0), Smart USB support • 1 x USB Type A (2.0), for FW upgrade • 1 x USB Type C (DP v. 1.2, PD Max 65W with OPS)(side I/O) • 1 x USB Type C (DP v. 1.2, PD Max 15W)(front I/O) • 1 x Audio In (3.5 mm) • 1 x LAN (RJ45)
Output Signal		<ul style="list-style-type: none"> • 1 x HDMI (1080p @ 60Hz/3840 x 2160 @ 60Hz) • 3 x USB Type B (for touch) • 1 x Audio Out (3.5 mm) • 1 SPDIF (optical) • 1 x LAN (RJ45)
Network	LAN	10M/100M (for Embedded Player) 10M/100M/1000M (for Slot-in PC)
	Wi-Fi	1 x Wi-Fi Slot
PC Slot		1 x 80-pin OPS
Speaker Output		2 x 16W (Speakers) 1 x 15W (Subwoofer)
RS-232		RS-232 Communication

Item	Category	Specifications
Power	Voltage	100V-240V AC 50/60Hz
Operating Conditions	Temperature	32° F to 104° F (0° C to 40° C)
	Humidity	20%~80% non-condensing
	Altitude	≤ 3,000 m
Storage Conditions	Temperature	-4° F to 140° F (-20° C to 60° C)
	Humidity	10%~90% non-condensing
	Altitude	≤ 3,000 m
Dimensions (W x H x D)	Physical (mm)	2507.2 x 1130.1 x 103.2
	Physical (in)	98.71" x 44.49" x 4.06"
Weight	Physical (kg)	91.4 kg
	Physical (lbs)	201.5 lbs
Power Consumption	On (Typical)	275W (ENERGY STAR)
	Off	< 0.5W

NOTE: Product specifications are subject to change without notice.

Display Modes

HDMI Mode

Resolution	Refresh Rate (@)
640 x 480	60Hz
800 x 600	60Hz
1024 x 768	60Hz
1280 x 720	50Hz, 60Hz
1280 x 768	60Hz
1280 x 800	60Hz
1280 x 960	60Hz
1280 x 1024	60Hz
1366 x 768	60Hz
1400 x 1050	60Hz
1440 x 900	60Hz
1600 x 900	60Hz
1680 x 1200	60Hz
1920 x 1080	30Hz, 50Hz, 60Hz
1920 x 1200	60Hz
2560 x 1440	60Hz
2560 x 1600	60Hz
3440 x 1440	60Hz
3840 x 2160	30Hz, 60Hz
4096 x 2160	30Hz, 50Hz, 60Hz
5120 x 2160	30Hz

Troubleshooting

This section describes some common problems that you may experience when using the ViewBoard.

Problem or Issue	Possible Solutions
Remote Control is not working	<ol style="list-style-type: none">1. Check whether something is obstructing the display's remote control receiver.2. Check whether the batteries in the remote control are installed correctly.3. Check whether the batteries need to be replaced.
The unit turns off unexpectedly	<ol style="list-style-type: none">1. Check whether Sleep mode is enabled.2. Check if there is a power outage in your area.3. Turn on the display and see if the problem is with the signal and control system.

PC Mode

Problem or Issue	Possible Solutions
No PC signal	<ol style="list-style-type: none">1. Check the display settings.2. Check the display resolution.3. Adjust the Hs & Vs (synchronization) settings using the OSD menu.
Background streaking	<ol style="list-style-type: none">1. Choose auto adjust.2. Adjust clock and phase.
Unsupported format	<ol style="list-style-type: none">1. Choose auto adjust.2. Adjust clock and phase settings.

Touch Function

Problem or Issue	Possible Solutions
Touch function does not work	<ol style="list-style-type: none">1. Check that drivers are installed correctly.2. Reinstall driver(s).3. Check setup and align it.4. Check whether the touch pen is working properly.

Video Not Working Properly

Problem or Issue	Possible Solutions
No picture/ No sound	<ol style="list-style-type: none">1. Check the Power status.2. Check the signal cable.3. Check that the internal PC is installed correctly.
Picture is unclear or cuts in and out	<ol style="list-style-type: none">1. Check the signal cable.2. Check if other electronics are interrupting the signal.
Poor picture	<ol style="list-style-type: none">1. Adjust chroma, brightness, and contrast settings in the menu.2. Check the signal cable.

Audio Not Working Properly

Problem or Issue	Possible Solutions
No sound	<ol style="list-style-type: none">1. Press the Mute/Unmute button.2. Adjust the volume.3. Check the audio cable.
One speaker only	<ol style="list-style-type: none">1. Adjust the sound balance in the menu.2. Check the sound control panel settings of the computer.3. Check the audio cable.

Maintenance

General Precautions

- Make sure the device is turned off and the power cable is unplugged from the power outlet.
- Never spray or pour any liquid directly onto the screen or case.
- Handle the device with care, as a darker-colored device, if scuffed, may show marks more clearly than a lighter-colored device.
- Do not use the system continuously for long periods of time.

Cleaning the Screen

- Wipe the screen with a clean, soft, lint-free cloth. This removes dust and other particles.
- If the screen is still not clean, apply a small amount of non-ammonia, non-alcohol based glass cleaner onto a clean, soft, lint-free cloth; then wipe the screen.

Cleaning the Case

- Use a soft, dry cloth.
- If the case is still not clean, apply a small amount of non-ammonia, non-alcohol based, mild non-abrasive detergent onto a clean, soft, lint-free cloth, then wipe the surface.

Disclaimer

- ViewSonic® does not recommend the use of any ammonia or alcohol-based cleaners on the display screen or case. Some chemical cleaners have been reported to damage the screen and/or case of the device.
- ViewSonic® will not be liable for damage resulting from use of any ammonia or alcohol-based cleaners.

NOTE: If condensation appears between the glass and the panel, keep the display turned on until the moisture disappears.

Regulatory and Service Information

Compliance Information

This section addresses all connected requirements and statements regarding regulations. Confirmed corresponding applications shall refer to nameplate labels and relevant markings on the unit.

FCC Compliance Statement

This device complies with part 15 of FCC Rules. Operation is subject to the following two conditions: (1) this device may not cause harmful interference, and (2) this device must accept any interference received, including interference that may cause undesired operation. This equipment has been tested and found to comply with the limits for a Class B digital device, pursuant to part 15 of the FCC Rules.

These limits are designed to provide reasonable protection against harmful interference in a residential installation. This equipment generates, uses, and can radiate radio frequency energy, and if not installed and used in accordance with the instructions, may cause harmful interference to radio communications. However, there is no guarantee that interference will not occur in a particular installation. If this equipment does cause harmful interference to radio or television reception, which can be determined by turning the equipment off and on, the user is encouraged to try to correct the interference by one or more of the following measures:

- Reorient or relocate the receiving antenna.
- Increase the separation between the equipment and receiver.
- Connect the equipment into an outlet on a circuit different from that to which the receiver is connected.
- Consult the dealer or an experienced radio/TV technician for help.

Warning: You are cautioned that changes or modifications not expressly approved by the party responsible for compliance could void your authority to operate the equipment.

Industry Canada Statement

CAN ICES-003(B) / NMB-003(B)

CE Conformity for European Countries



The device complies with the EMC Directive 2014/30/EU and Low Voltage Directive 2014/35/EU.

The following information is only for EU-member states:

The mark shown to the right is in compliance with the Waste Electrical and Electronic Equipment Directive 2012/19/EU (WEEE). The mark indicates the requirement NOT to dispose of the equipment as unsorted municipal waste, but use the return and collection systems according to local law.



Declaration of RoHS2 Compliance

This product has been designed and manufactured in compliance with Directive 2011/65/EU of the European Parliament and the Council on restriction of the use of certain hazardous substances in electrical and electronic equipment (RoHS2 Directive) and is deemed to comply with the maximum concentration values issued by the European Technical Adaptation Committee (TAC) as shown below:

Substance	Proposed Maximum Concentration	Actual Concentration
Lead (Pb)	0.1%	< 0.1%
Mercury (Hg)	0.1%	< 0.1%
Cadmium (Cd)	0.01%	< 0.01%
Hexavalent Chromium (Cr6 ⁺)	0.1%	< 0.1%
Polybrominated biphenyls (PBB)	0.1%	< 0.1%
Polybrominated diphenyl ethers (PBDE)	0.1%	< 0.1%
Bis (2-ethylhexyl) phthalate (DEHP)	0.1%	< 0.1%
Butyl benzyl phthalate (BBP)	0.1%	< 0.1%
Dibutyl phthalate (DBP)	0.1%	< 0.1%
Diisobutyl phthalate (DIBP)	0.1%	< 0.1%

Certain components of products as stated above are exempted under the Annex III of the RoHS2 Directives as noted below:

- Copper alloy containing up to 4% lead by weight.
- Lead in high melting temperature type solders (i.e. lead-based alloys containing 85% by weight or more lead).
- Electrical and electronic components containing lead in a glass or ceramic other than dielectric ceramic in capacitors, e.g. piezoelectronic devices, or in a glass or ceramic matrix compound.
- Lead in dielectric ceramic in capacitors for a rated voltage of 125V AC or 250V DC or higher.

ENERGY STAR Statement

ENERGY STAR is a U.S. Environmental Protection Agency voluntary program that helps businesses and individuals save money and protect our climate through superior energy efficiency. Products that earn the ENERGY STAR prevent greenhouse gas emissions by meeting strict energy efficiency criteria or requirements set by the U.S. Environmental Protection Agency.

As an ENERGY STAR Partner, ViewSonic is determined to meet the Energy star Guidelines and mark all certified models with the ENERGY STAR logo.

The following logo appears on all ENERGY STAR-certified models:



NOTE: The power management features significantly reduce energy consumption when the product is not in use. Power management allows the device to automatically enter a low power “sleep” mode after a defined period of inactivity. And the power management features also enter Sleep Mode or Off Mode within 5 minutes of being disconnected from a host computer. Please note any change in energy settings will increase energy consumption.

Indian Restriction of Hazardous Substances

Restriction on Hazardous Substances statement (India). This product complies with the “India E-waste Rule 2011” and prohibits use of lead, mercury, hexavalent chromium, polybrominated biphenyls or polybrominated diphenyl ethers in concentrations exceeding 0.1 weight % and 0.01 weight % for cadmium, except for the exemptions set in Schedule 2 of the Rule.

Product Disposal at End of Product Life

ViewSonic® respects the environment and is committed to working and living green. Thank you for being part of Smarter, Greener Computing. Please visit the ViewSonic® website to learn more.

USA & Canada:

<https://www.viewsonic.com/us/go-green-with-viewsonic>

Europe:

<https://www.viewsonic.com/eu/go-green-with-viewsonic>

Taiwan:

<https://recycle.epa.gov.tw/>

Copyright Information

Copyright© ViewSonic® Corporation, 2023. All rights reserved.

Macintosh and Power Macintosh are registered trademarks of Apple Inc.

Microsoft, Windows, and the Windows logo are registered trademarks of Microsoft Corporation in the United States and other countries.

ViewSonic® and the three birds logo are registered trademarks of ViewSonic® Corporation.

VESA is a registered trademark of the Video Electronics Standards Association. DPMS, DisplayPort, and DDC are trademarks of VESA.

ENERGY STAR® is a registered trademark of the U.S. Environmental Protection Agency (EPA).

As an ENERGY STAR® partner, ViewSonic® Corporation has determined that this product meets the ENERGY STAR® guidelines for energy efficiency.

Disclaimer: ViewSonic® Corporation shall not be liable for technical or editorial errors or omissions contained herein; nor for incidental or consequential damages resulting from furnishing this material, or the performance or use of this product.

In the interest of continuing product improvement, ViewSonic® Corporation reserves the right to change product specifications without notice. Information in this document may change without notice.

No part of this document may be copied, reproduced, or transmitted by any means, for any purpose without prior written permission from ViewSonic® Corporation.

Customer Service

For technical support or product service, see the table below or contact your reseller.

NOTE: You will need the product's serial number.

Country/ Region	Website	Country/ Region	Website
Asia Pacific & Africa			
Australia	www.viewsonic.com/au/	Bangladesh	www.viewsonic.com/bd/
中国 (China)	www.viewsonic.com.cn	香港 (繁體中文)	www.viewsonic.com/hk/
Hong Kong (English)	www.viewsonic.com/hk-en/	India	www.viewsonic.com/in/
Indonesia	www.viewsonic.com/id/	Israel	www.viewsonic.com/il/
日本 (Japan)	www.viewsonic.com/jp/	Korea	www.viewsonic.com/kr/
Malaysia	www.viewsonic.com/my/	Middle East	www.viewsonic.com/me/
Myanmar	www.viewsonic.com/mm/	Nepal	www.viewsonic.com/np/
New Zealand	www.viewsonic.com/nz/	Pakistan	www.viewsonic.com/pk/
Philippines	www.viewsonic.com/ph/	Singapore	www.viewsonic.com/sg/
臺灣 (Taiwan)	www.viewsonic.com/tw/	ประเทศไทย	www.viewsonic.com/th/
Việt Nam	www.viewsonic.com/vn/	South Africa & Mauritius	www.viewsonic.com/za/
Americas			
United States	www.viewsonic.com/us	Canada	www.viewsonic.com/us
Latin America	www.viewsonic.com/la		
Europe			
Europe	www.viewsonic.com/eu/	France	www.viewsonic.com/fr/
Deutschland	www.viewsonic.com/de/	Қазақстан	www.viewsonic.com/kz/
Россия	www.viewsonic.com/ru/	España	www.viewsonic.com/es/
Türkiye	www.viewsonic.com/tr/	Україна	www.viewsonic.com/ua/
United Kingdom	www.viewsonic.com/uk/		

Limited Warranty

ViewSonic® Smart White Board

What the warranty covers:

ViewSonic® warrants its products to be free from defects in material and workmanship during the warranty period. If a product proves to be defective in material or workmanship during the warranty period, ViewSonic® will, at its sole option, and as your sole remedy, repair or replace the product with a similar product. Replacement Product or parts may include remanufactured or refurbished parts or components. The repair or replacement unit or parts or components will be covered by the balance of the time remaining on the customer's original limited warranty and the warranty period will not be extended. ViewSonic® provides no warranty for any third-party software whether included with the product or installed by the customer, installation of any unauthorized hardware parts or components (e.g. Projector Lamps). (Please refer to: "What the warranty excludes and does not cover" section).

Who the warranty protects:

This warranty is valid only for the first consumer purchaser.

What the warranty excludes and does not cover:

- Any product on which the serial number has been defaced, modified, or removed.
- Damage, deterioration, or malfunction resulting from:
 - » Accident, misuse, neglect, fire, water, lightning, or other acts of nature, unauthorized product modification, or failure to follow instructions supplied with the product.
 - » Repair or attempted repair by anyone not authorized by ViewSonic®.
 - » Damage to or loss of any programs, data, or removable storage media.
 - » Normal wear and tear.
 - » Removal or installation of the product.
- Software or data loss occurring during repair or replacement.
- Any damage of the product due to shipment.
- Causes external to the product, such as electric power fluctuations or failure.
- Use of supplies or parts not meeting ViewSonic's specifications.
- Failure of owner to perform periodic product maintenance as stated in the User Guide.

- Any other cause which does not relate to a product defect.
- Damage caused by static (non-moving) images displayed for lengthy periods of time (also referred to as image burn-in).
- Software - Any third-party software included with the product or installed by the customer.
- Hardware/Accessories/Parts/Components – Installation of any unauthorized hardware, accessories, consumable parts or components (e.g. Projector Lamps).
- Damage to, or abuse of, the coating on the surface of the display through inappropriate cleaning as described in the product User Guide.
- Removal, installation, and set-up service charges, including wall-mounting of the product.

How to get service:

- For information about receiving service under warranty, contact ViewSonic® Customer Support (Please refer to the “Customer Service” page). You will need to provide your product’s serial number.
- To obtain warranty service, you will be required to provide: (a) the original dated sales slip, (b) your name, (c) your address, (d) a description of the problem, and (e) the serial number of the product.
- Take or ship the product, freight prepaid, in the original container to an authorized ViewSonic® service center or ViewSonic®.
- For additional information or the name of the nearest ViewSonic® service center, contact ViewSonic®.

Limitation of implied warranties:

There are no warranties, express or implied, which extend beyond the description contained herein including the implied warranty of merchantability and fitness for a particular purpose.

Exclusion of damages:

ViewSonic's liability is limited to the cost of repair or replacement of the product. ViewSonic® shall not be liable for:

- Damage to other property caused by any defects in the product, damages based upon inconvenience, loss of use of the product, loss of time, loss of profits, loss of business opportunity, loss of goodwill, interference with business relationships, or other commercial loss, even if advised of the possibility of such damages.
- Any other damages, whether incidental, consequential or otherwise.
- Any claim against the customer by any other party.
- Repair or attempted repair by anyone not authorized by ViewSonic®.

Effect of state law:

This warranty gives you specific legal rights, and you may also have other rights which vary from state to state. Some states do not allow limitations on implied warranties and/or do not allow the exclusion of incidental or consequential damages, so the above limitations and exclusions may not apply to you.

Sales outside the U.S.A. and Canada:

For warranty information and service on ViewSonic® products sold outside of the U.S.A. and Canada, contact ViewSonic® or your local ViewSonic® dealer.

The warranty period for this product in mainland China (Hong Kong, Macao, and Taiwan Excluded) is subject to the terms and conditions of the Maintenance Guarantee Card.

For users in Europe and Russia, full details of warranty provided can be found at: <http://www.viewsonic.com/eu/> under "Support/Warranty Information".

Mexico Limited Warranty

ViewSonic® Smart White Board

What the warranty covers:

ViewSonic® warrants its products to be free from defects in material and workmanship, under normal use, during the warranty period. If a product proves to be defective in material or workmanship during the warranty period, ViewSonic® will, at its sole option, repair or replace the product with a like product. Replacement product or parts may include remanufactured or refurbished parts or components & accessories.

Who the warranty protects:

This warranty is valid only for the first consumer purchaser.

What the warranty excludes and does not cover:

- Any product on which the serial number has been defaced, modified or removed.
- Damage, deterioration, or malfunction resulting from:
 - » Accident, misuse, neglect, fire, water, lightning, or other acts of nature, unauthorized product modification, unauthorized attempted repair, or failure to follow instructions supplied with the product.
 - » Causes external to the product, such as electrical power fluctuations or failure.
 - » Use of supplies or parts not meeting ViewSonic®'s specifications.
 - » Normal wear and tear.
 - » Any other cause which does not relate to a product defect.
- Any product exhibiting a condition commonly known as “image burn-in” which results when a static image is displayed on the product for an extended period of time.
- Removal, installation, insurance, and set-up service charges.

How to get service:

For information about receiving service under warranty, contact ViewSonic® Customer Support (Please refer to the attached “Customer Service” page). You will need to provide your product’s serial number, so please record the product information in the space provided below on your purchase for your future use. Please retain your receipt of proof of purchase to support your warranty claim.

For Your Records

Product Name: _____ Model Number: _____
Document Number: _____ Serial Number: _____
Purchase Date: _____ Extended Warranty Purchase? _____(Y/N)
If so, what date does warranty expire? _____

- To obtain warranty service, you will be required to provide (a) the original dated sales slip, (b) your name, (c) your address, (d) a description of the problem, and (e) the serial number of the product.
- Take or ship the product, in the original container packaging, to an authorized ViewSonic® service center.
- Round trip transportation costs for in-warranty products will be paid by ViewSonic®.

Limitation of implied warranties:

There are no warranties, express or implied, which extend beyond the description contained herein including the implied warranty of merchantability and fitness for a particular purpose.

Exclusion of damages:

ViewSonic®’s liability is limited to the cost of repair or replacement of the product. ViewSonic® shall not be liable for:

- Damage to other property caused by any defects in the product, damages based upon inconvenience, loss of use of the product, loss of time, loss of profits, loss of business opportunity, loss of goodwill, interference with business relationships, or other commercial loss, even if advised of the possibility of such damages.
- Any other damages, whether incidental, consequential or otherwise.
- Any claim against the customer by any other party.
- Repair or attempted repair by anyone not authorized by ViewSonic®.

Contact Information for Sales & Authorized Service (Centro Autorizado de Servicio) within Mexico:	
Name, address, of manufacturer and importers: México, Av. de la Palma #8 Piso 2 Despacho 203, Corporativo Interpalmas, Col. San Fernando Huixquilucan, Estado de México Tel: (55) 3605-1099 http://www.viewsonic.com/la/soporte/index.htm	
NÚMERO GRATIS DE ASISTENCIA TÉCNICA PARA TODO MÉXICO: 001.866.823.2004	
Hermosillo: Distribuciones y Servicios Computacionales SA de CV. Calle Juarez 284 local 2 Col. Bugambilias C.P: 83140 Tel: 01-66-22-14-9005 E-Mail: disc2@hmo.megared.net.mx	Villahermosa: Compumantenimientos Garantizados, S.A. de C.V. AV. GREGORIO MENDEZ #1504 COL, FLORIDA C.P. 86040 Tel: 01 (993) 3 52 00 47 / 3522074 / 3 52 20 09 E-Mail: compumantenimientos@prodigy.net.mx
Puebla, Pue. (Matriz): RENTA Y DATOS, S.A. DE C.V. Domicilio: 29 SUR 721 COL. LA PAZ 72160 PUEBLA, PUE. Tel: 01(52).222.891.55.77 CON 10 LINEAS E-Mail: datos@puebla.megared.net.mx	Veracruz, Ver.: CONEXION Y DESARROLLO, S.A DE C.V. Av. Americas # 419 ENTRE PINZÓN Y ALVARADO Fracc. Reforma C.P. 91919 Tel: 01-22-91-00-31-67 E-Mail: gacosta@qplus.com.mx
Chihuahua: Soluciones Globales en Computación C. Magisterio # 3321 Col. Magisterial Chihuahua, Chih. Tel: 4136954 E-Mail: Cefeo@soluglobales.com	Cuernavaca: Compusupport de Cuernavaca SA de CV Francisco Leyva # 178 Col. Miguel Hidalgo C.P. 62040, Cuernavaca Morelos Tel: 01 777 3180579 / 01 777 3124014 E-Mail: aquevedo@compusupportcva.com
Distrito Federal: QPLUS, S.A. de C.V. Av. Coyoacán 931 Col. Del Valle 03100, México, D.F. Tel: 01(52)55-50-00-27-35 E-Mail : gacosta@qplus.com.mx	Guadalajara, Jal.: SERVICRECE, S.A. de C.V. Av. Niños Héroes # 2281 Col. Arcos Sur, Sector Juárez 44170, Guadalajara, Jalisco Tel: 01(52)33-36-15-15-43 E-Mail: mmiranda@servicrece.com
Guerrero Acapulco: GS Computación (Grupo Sesicomp) Progreso #6-A, Colo Centro 39300 Acapulco, Guerrero Tel: 744-48-32627	Monterrey: Global Product Services Mar Caribe # 1987, Esquina con Golfo Pérsico Fracc. Bernardo Reyes, CP 64280 Monterrey N.L. México Tel: 8129-5103 E-Mail: aydeem@gps1.com.mx
MERIDA: ELECTROSER Av Reforma No. 403Gx39 y 41 Mérida, Yucatán, México CP97000 Tel: (52) 999-925-1916 E-Mail: rrrb@sureste.com	Oaxaca, Oax.: CENTRO DE DISTRIBUCION Y SERVICIO, S.A. de C.V. Murguía # 708 P.A., Col. Centro, 68000, Oaxaca Tel: 01(52)95-15-15-22-22 Fax: 01(52)95-15-13-67-00 E-Mail: gpotai2001@hotmail.com
Tijuana: STD Av Ferrocarril Sonora #3780 L-C Col 20 de Noviembr Tijuana, Mexico	FOR USA SUPPORT: ViewSonic® Corporation 381 Brea Canyon Road, Walnut, CA. 91789 USA Tel: 800-688-6688 E-Mail: http://www.viewsonic.com



ViewSonic®