

Envertech EVT560 Quick Installation Guide



Please read and follow the safety and installation instructions below. You can find and download the instructions or other technical documents on our website: www.envertec.com

Components

Microinverter	Monitoring Device	EnverPortal
EVT560	EnverBridge	www.envertecportal.com



PV Module	60-cell / 72-cell module	
AC Extension Cable (Optional)	To connect the AC side to the grid. Three-wire cable: AWG12 or above.	
AC End Cap	To seal the end of unused AC cable.	

Envertech EVT 560 Microinverter Installation



Installation could only be implemented when the system is disconnected from the grid, and the solar panel has been covered or disconnected.

1. Mount microinverters onto the rack

Mark out the estimated center of each PV module on the rack to facilitate locating microinverters.

Mount all microinverters under modules to avoid rain and sun, with the trademark facing downward.

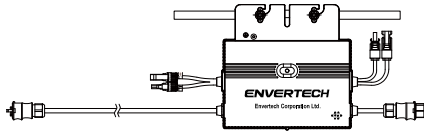

Please make sure that there are less than 10 units of EVT560 in each branch(12AWG).

2. Grounding

Microinverters and modules must be connected to the grounding conductor in accordance with national standards.

Fix the grounding wire with screws to the microinverter's grounding hole, so that the grounding of microinverters can be realized.

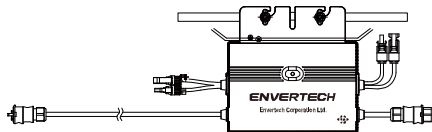

3. Connect microinverter AC cables serially

Connect the AC connectors on both sides of microinverters in a hand-in-hand way.

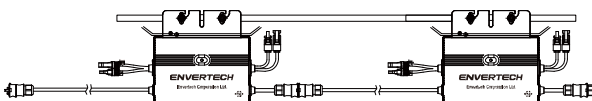

4. Fasten AC cables

Fasten AC cables and grounding cables to the rack with cable ties.

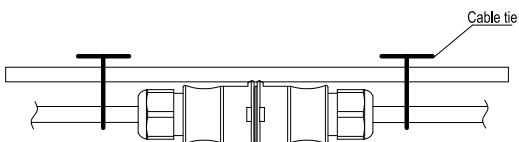

5. Seal the unused connector of AC cable

Insert the end cap directly into the connector on the unused end, and check if it is inserted in place.

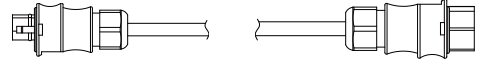

6. Connect AC cable to the junction box

Connect AC cable to the input of the junction box.

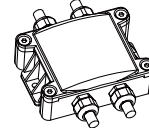

7. Mount EnverBridge

Option 1: Indoor installation (I)

1. Turn off the air switch and connect EnverBridge to the socket. This operation should be done under the instruction of professionals.
2. Fix EnverBridge at proper position in or close to the distribution box;
3. Open the cover on the right side of EnverBridge. Run the RJ45 cable through the waterproof connector and connect it to the network input. Close the cover and recheck if it's completely sealed;
4. Run the RJ45 cable and connect the other side to your router;
5. Put the EnverBridge plug into the socket.

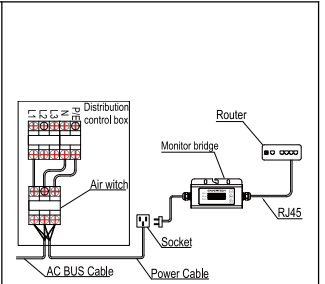

Option 2: Indoor installation (II)

1. Open the cover on the right side of EnverBridge. Run the RJ45 cable through the water proof connector and connect it to the network input. Close the cover and recheck if it's completely sealed;
2. Run the RJ45 cable and connect it to your router;
3. Fix EnverBridge at proper position in or close to the distribution box;
4. Turn off the air switch and connect EnverBridge's power cable to the air switch. This operation should be done under the instruction of professionals.

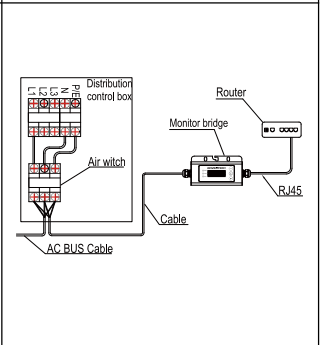

8. Prepare AC extension cable

- 1) Remove the skin of the two ends of the extension cable by $y=40\text{mm}$ and remove the skin of internal wires by $x=14\text{mm}$. Set the metal terminals onto the open parts and clamp them to tighten the connection;

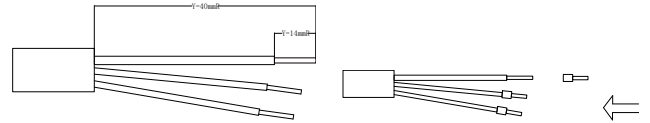

- 2) Connect one side of the extension cable to the junction box;

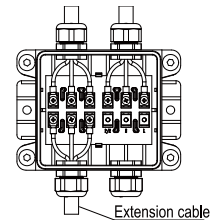

- 3) Connect the other side of the extension cable to the air switch.

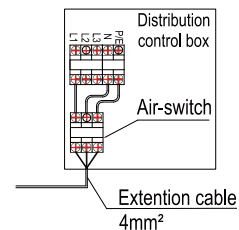

9. Connect PV modules to microinverters

Mount the PV modules on top of microinverters;

Connect each PV module with the DC input cables of the microinverter.

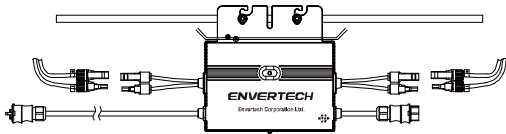

10. Switch on the PV system

Ensure all connection is completed and then turn on the air switch.

11. Monitoring

1) Register a new account. Visit www.envertecportal.com. Click Sign Up. Fill in the account information to finish registration.



2) EVB202 MI Binding

Option 1. Use Enview app to bind MI

Step 1: Login your account on your mobile phone. Then go to "Settings".

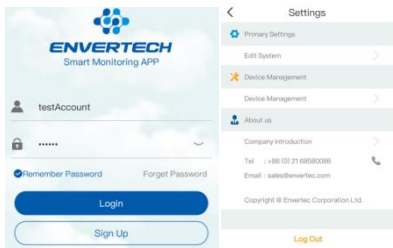

Step 2: Under "Device Management", click "Add" and enter MI SN manually or click the QR Code icon on the right to scan the MI SN automatically.

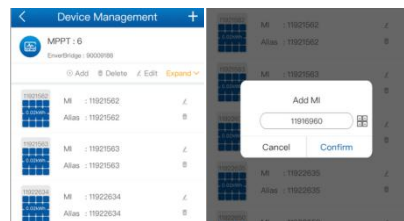

Step 3: Click "Confirm" to finish adding the MI.

Option 2. Use EnverPortal to bind MI

Step 1: Login www.envertecportal.com with the newly-registered account, go to Settings--Management.

Step 2: Click Add, then enter the SN of EnverBridge, click OK to finish adding monitor.

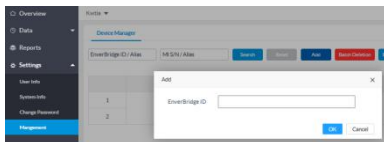

Step 3: Click "+" button behind the EnverBridge SN, then enter the SN of microinverter, click OK to finish binding.

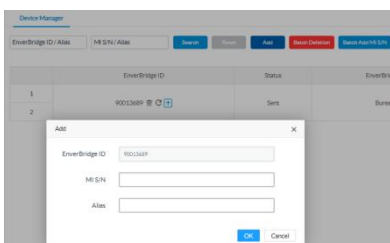

Option 3. Use your computer to bind MIs

Step 1: Please visit the Download Center on our website www.envertec.com and download Set ID exe. in your computer.



Open the software as below.

Step 2 : Please make sure your EVB202 is connected to the same router as your computer is connected. And use the scanner to scan or manually input the EVB202 ID and the inverter IDs into the software as below.



Step 3 : Please press [Set MI ID], you will see the content shown as below.

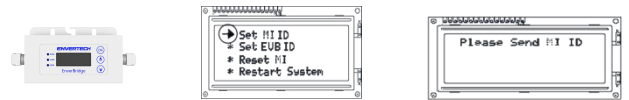

Step 4 : Then you can press "Send" button in the software to complete the setting. Meanwhile, "ID Set OK" will be also shown on the EVB202 screen. Thus the MI binding process is completed.



12. Attachment:

1. Single Phase

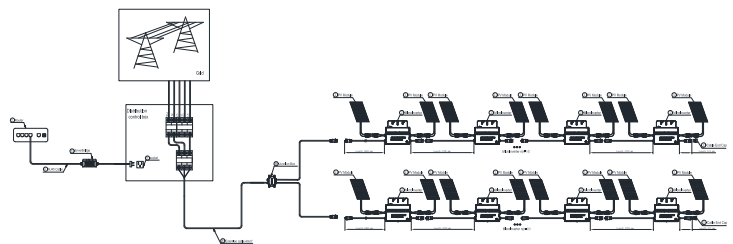
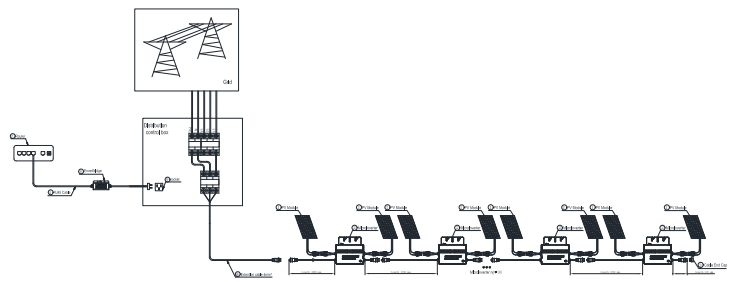

2. Three Phase

