

Fitting The Wand Tonearm® to a Thorens TD160 family turntable (TD150/166 similar)

You should be able to use the Thorens arm lifter with The Wand Tonearm

To be read in conjunction with The Wand User Guide.

A; Remove the existing arm

Step 1; Remove the platter, headshell and Lifter bar (arrowed) Disconnect from power!



Step 2; Support the turntable upside down and remove the bottom cover. 4 screws.

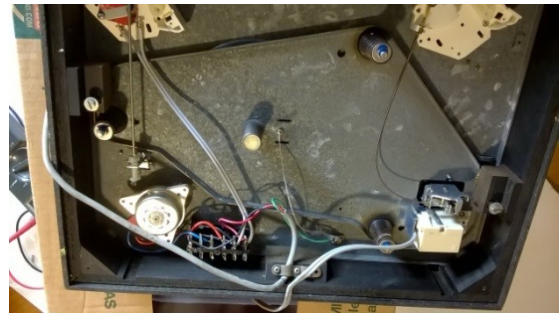

Step 3; Remove the arm cable clamp and the white cable cover.

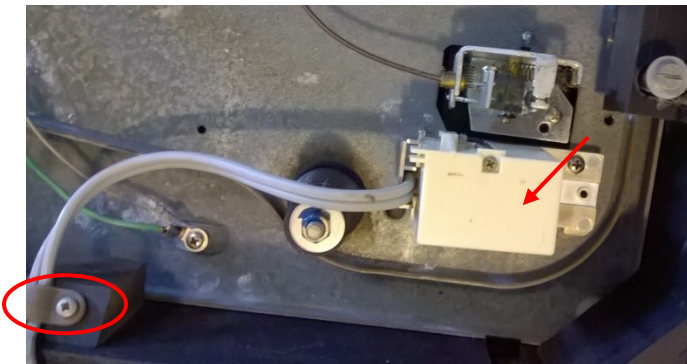

Step 4; Unhook the lift mechanism

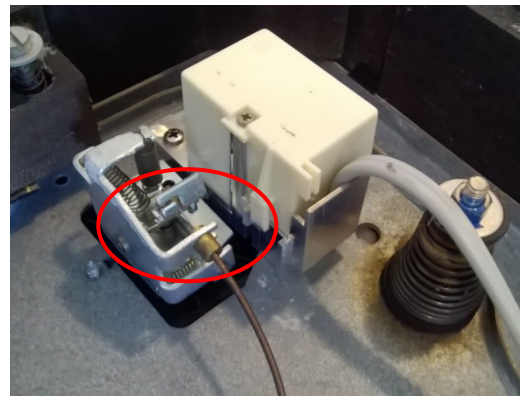

Step 5; Remove the cable base (Two screws)

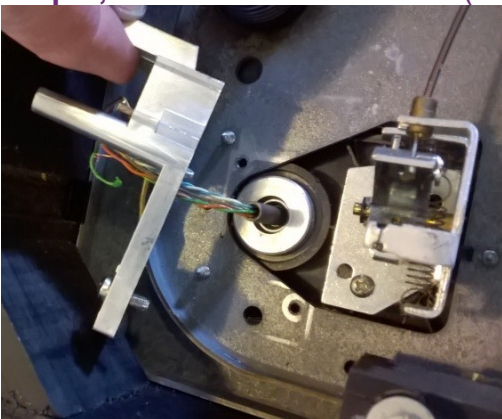

Step 6; Remove the armrest (two screws)

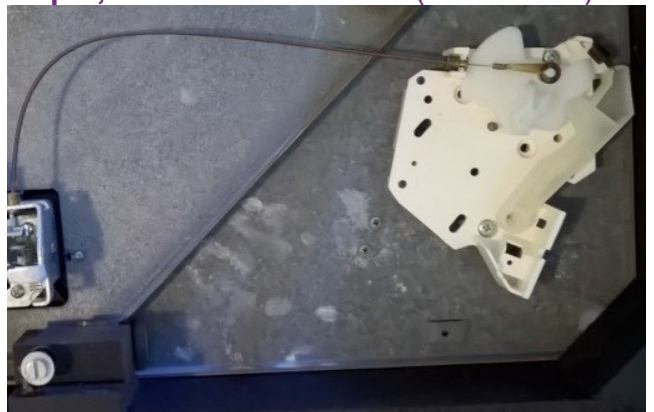

Step 7; Turn over and remove the arm. (Three screws)

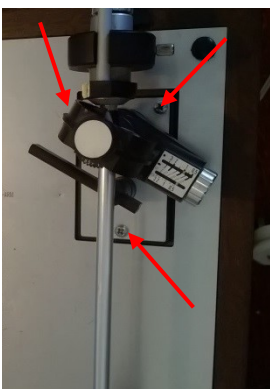

Hint; Improve your Thorens by adding damping material to the underside of the sheetmetal panels and the bottom cover while it is off. (but watch adding too much weight to the floating chassis part)

THE **WAND**®
UNIPIVOT TONEARM

www.thewandtonearm.com

©Sept 2016 design build listen Ltd. v2-3

Fitting The Wand Tonearm® to a Thorens TD160 family turntable (TD150/165 similar)

You may choose to use the Thorens arm lifter with The Wand To be read in conjunction with The Wand User Guide.

B; Prepare The Wand Mounting

Step 1; Stack the Steel plate on top of black acrylic

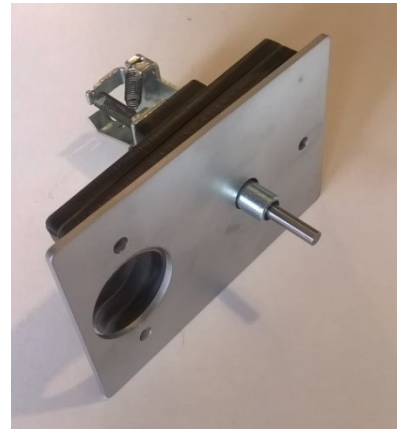

Step 2; Add the Wand mount & feed through the plinth (Wand Classic left, Wand Plus right below)



Step 3; Screw in but don't tighten. (Three screws)

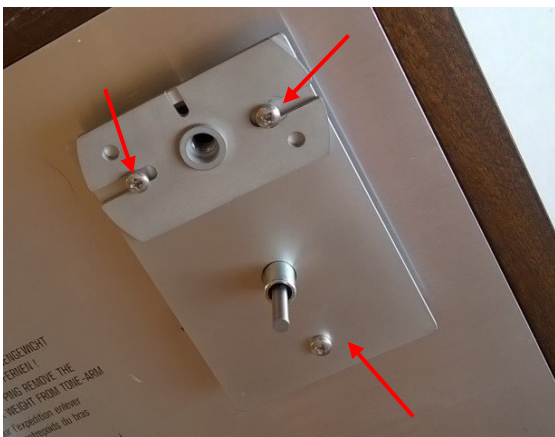

Step 4; Add earth wire to amplifier. (as below) or 3 core mains cable.



Step 5; Add the Thorens lifter to the underside (if you are using it) Use 2x self-tapping screws.

See previous page for correct orientation. Re-connect the lifter cable.

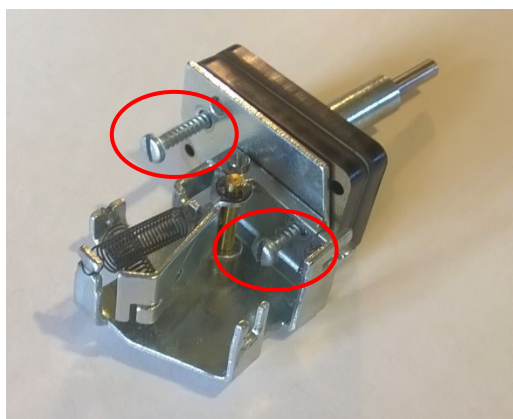

Note; If you want to route the wiring into the plinth. Feed through the slot in the Wand mount before adding screws. (But good to 'practice' the other steps first)

THE WAND
UNIPIVOT TONEARM

www.thewandtonearm.com

©Sept 2016 design build listen Ltd. v2-3

Fitting The Wand Tonearm® to a Thorens TD160 family turntable (TD150/165 similar)

C; Fitting The Wand Tonearm Mount

Step 1; Install the spindle into mounting plate. Set the spindle height using the protractor. Lock in position using the nut (Classic) or grub screw (Plus). Thorens have limited height so it is hard to get the arm down to level (+2° OK). If important, one nut can lock from below plate.

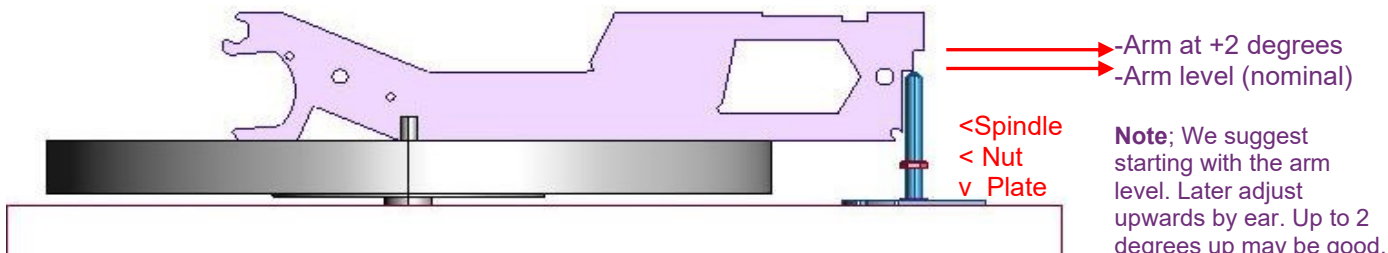

Step 2; Position the mount using the protractor (Slide back and forth)



Step 3; Tighten the three screws

Step 4; Add the Lifter (Wand Plus on left / Thorens for Classic on right).

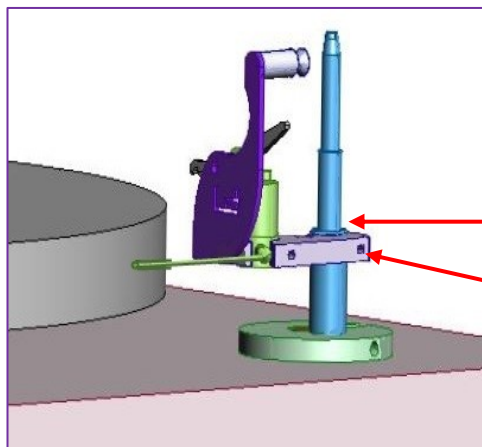

Align to just below the step.

Lock with small hex key.



Lock with small hex key. Slide up / down to set lift Height (very fiddly!)

Step 5; Revert to main instructions for the remainder of the setup and enjoy!



"this is a mandatory upgrade for the TD160"
Tim, USA

"The improvement over the Thorens arm is astonishing. Detail, timing, but most of all soundstage depth."
Richard, Dunedin, New Zealand

THE WAND®
UNIPIVOT TONEARM