

# Joybos® Metal Kitchen Pantry Storage Cabinet with DIY Pegboard Wall

## ---Installation instruction

Thanks very much to buy our company's products, please read this instruction carefully 1st before using it, and don't throw it away as you may need it in the future.

### **Instruction before installation:**

1. Make sure you get all the accessories before installation;
2. Install it according to this instruction exactly to make sure correct and safe installation;
3. Make sure all the screws and other small accessories are kept away from children when installation.

### **Precautions for use:**

1. To avoid corrosion, please don't put this product in a damp location or outdoor environment;
2. Please don't seat or jump on it, also don't use this product as a platform to get other products, especially pay more attention and noticed children about it.
3. To avoid transformation and damage please locate it on a flat floor.
4. Please do not put all articles in one layer, the heavy articles should be put on the ground floor.
5. Please use the adjustable leg to adjust it on the floor and make sure it is steady.
6. No other use.

### **Maintain instruction:**

1. Please stop to use it if it has breakage or transformation;
2. Please check assembly parts carefully every 3 months, and stop to use them if it has safely potential risk;
3. Please use clean fabric to wipe it when it is dirty, use detergent or furniture cleaning agent in the market to scrub it when it has seriously dirty.
4. To avoid discoloration or painting fall off, please don't use ethyl alcohol, banana oil or another chemical solvent to clean this product;
5. Please don't fix it or remould this product yourself to avoid influencing useful life.







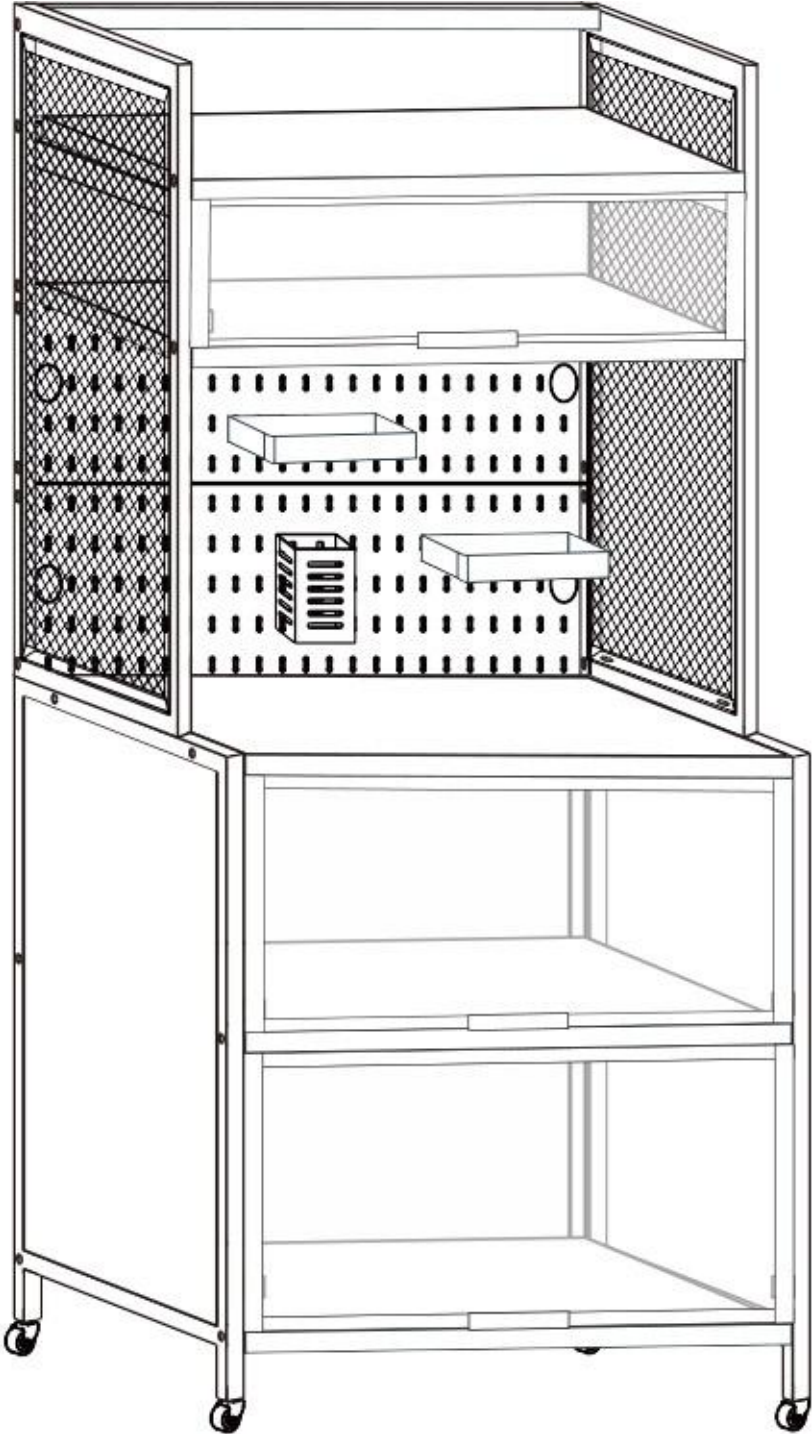



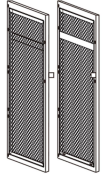
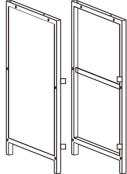

### **Remark:**

Uniform weight capacity for this item: within **15kg** whole shell.

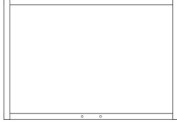
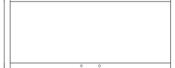
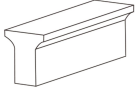
1、 Product demonstration

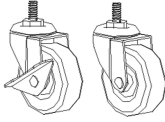

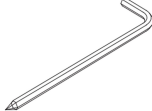
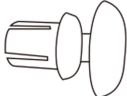
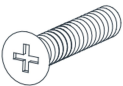
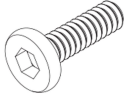
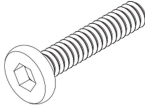
## 2、 Parts list

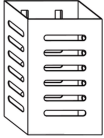
NO.	1	2	3	4	5	6
Pic.						
Name	Upper Bracket	Lower Bracket	Large Laminated	Middle Board	Small Laminated	Large Backplane
Qty.	2	2	2	1	2	2
NO.	7	8	9	10	11	12
Pic.						
Name	Small Backplane	Breathable Back Panel	Door Frame	Small Door Frame	Handle	Magnet
Qty.	1	2	2	1	3	6
NO.	13	14	15	16	17	
Pic.						
Name	Cardan wheels	Horizontal Pipe	Hexagon Dual Wrench	Plastic Rivet	Round head Phillips Screw	
Qty.	4	1	1	12	6	
NO.	18	19	20	21		
Pic.						
Name	Short Hexagon Socket Flat Head Screws	Long hexagon socket flat head screws	Handle	Magnet		
Qty.	4	30	2	1		

### 3、Installation steps

Step1: Screw the Cardan wheels into the lower bracket, and then fix the upper and lower brackets with Short hexagon socket flat head screws, as shown in Figure 1;

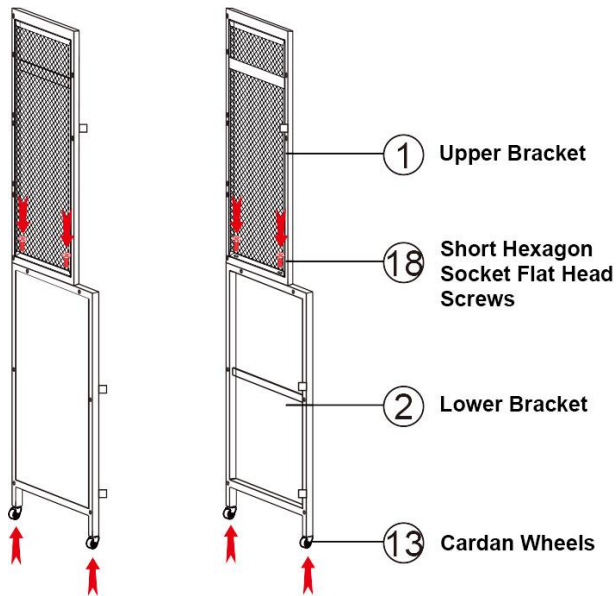

Figure 1

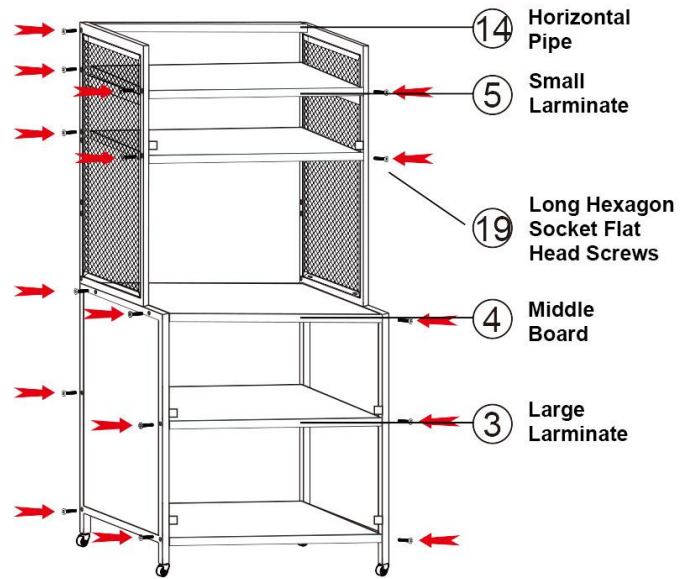

Figure 2

Step 2: Use long hexagon socket flat head screws to fix the bracket with the laminate and the horizontal pipe, do not lock it completely, as shown in Figure 2;

Step 3: Turn the shelf over, align the holes on the backplane and the bracket, and then press the plastic rivets into the holes of the bracket to fix the large and small backplane. Then fix the Breathable back panel with long hexagon socket flat head screws. After installing all the backplanes. Then tighten the screws of the laminate, as shown in Figure 3;

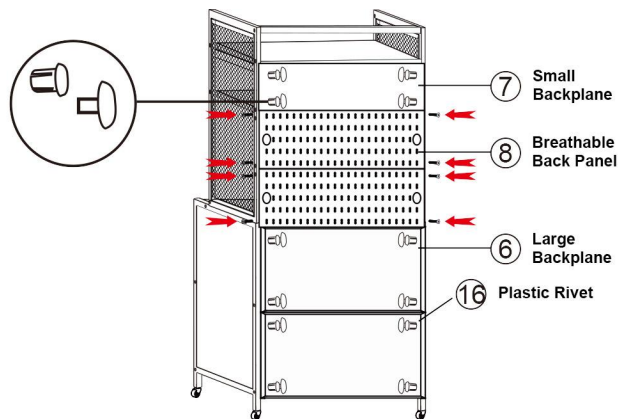

Figure 3

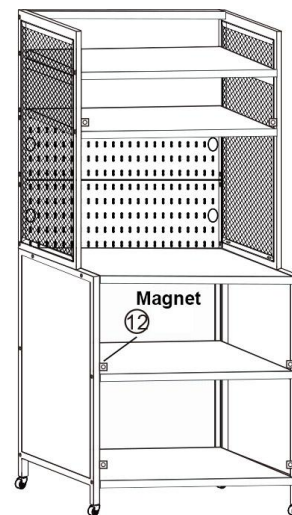

Figure 4

Step 4: Tear off the 3M adhesive tape on the back of the sticker, and then paste the adhesive side on the left and right sides, as shown in Figure 4;

Step 5: Use round head Phillips screws to install the handle into the door frame, as shown in Figure 5;

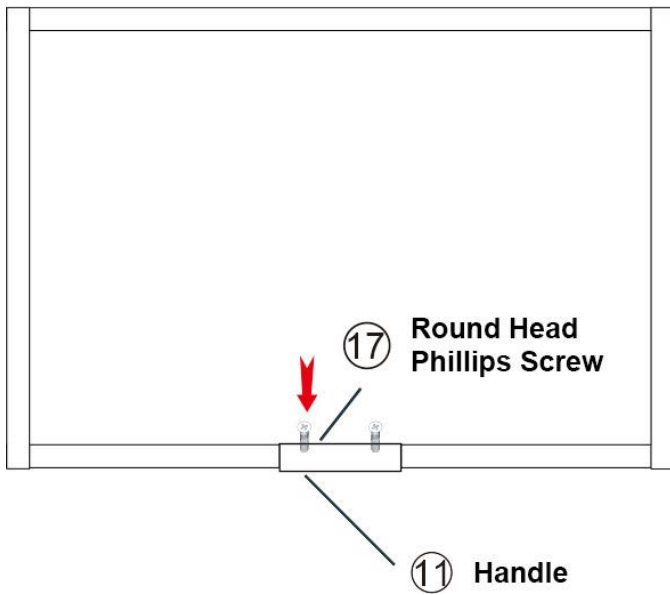

Figure 5

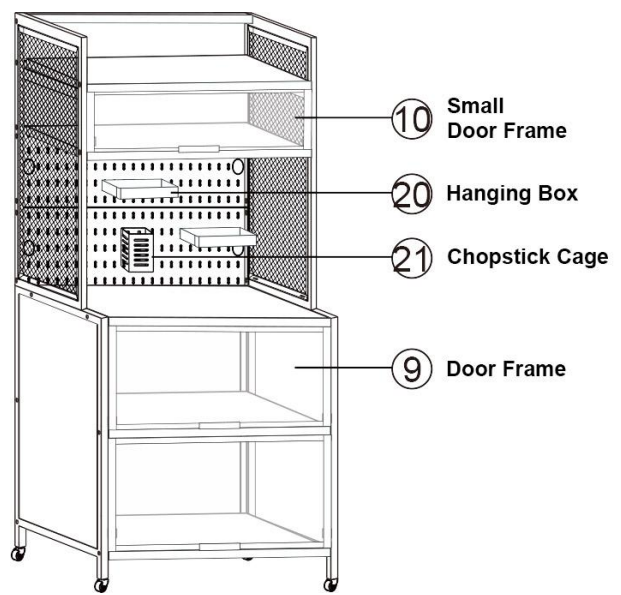

Figure 6

Step6: Press the buckles on both sides of the door frame, snap the large and small frames into the left and right brackets, and then hang the hanging box and chopstick cage on the shelf, as shown in Figure 6.