

Voltask

USER MANUAL

Read All Instructions Before First Use.
Keep This Manual For Future Reference.

20V/12-INCH Cordless Snow Shovel SS-20E

SS-20E



Thank you for purchasing our Voltask 12-Inch Cordless Snow Shovel. Your support is much appreciated. Our products are designed and manufactured to meet the highest standards for user safety. With proper care and maintenance, your Voltask will provide you with years of safe, reliable, and trouble-free service. If you have any problems, please email Voltask at support@voltask.com.

Website: www.voltask.com
Email: support@voltask.com
FB: [@voltasktools](https://www.facebook.com/voltasktools)
IG: [@voltasktools](https://www.instagram.com/voltasktools)



Read all safety rules and instructions carefully before operating this tool. Save this user manual for future reference.

If you are selling this product secondhand, you must provide either the original instruction manual or information on how to use it in a safe way.

TECHNICAL SPECIFICATIONS

12-Inch Cordless Snow Shovel	
Model No.	SS-20E
Rated Voltage	20 V
Rotation Speed	2,300 rpm
Battery Charge Time Max	2 hr.
Battery Run Time Max	40 min.
Clearing Width	12 in. (305 mm)
Motor	887 / 500W Brushed Motor
Clearing Depth	4.2 in. (108mm)
Throwing Distance	13.1 ft. (4 m)
Throwing Height	7.2 ft. (2.2m)
Angle Adjustment	+/- 30 degree
Weight (snow shovel with battery installed)	9 lbs (4.12 kg)

This power tool is to be used only with the accessory parts listed under “Optional Accessories.” This product is not intended for commercial use. Generally acknowledged accident-prevention regulations and endorsed safety instructions must be observed.

Perform only the work described in these instructions. Any other use of this product is improper. The manufacturer will not assume responsibility for damage resulting from such use.

CONTENTS

PACKAGE CONTENTS 01

SYMBOLS 02

GENERAL SAFETY INSTRUCTIONS 04

BATTERY AND CHARGER 07

PRODUCT OVERVIEW 11

ASSEMBLY 12

OPERATION 16

MAINTENANCE AND STORAGE 19

OPTIONAL ACCESSORIES 21

TROUBLESHOOTING 22

WARRANTY 23

PACKAGE CONTENTS

SS-20E



Snow
shovel × 1



Assembly × 1



Accessories
package × 1



Battery pack × 1



Battery charger
× 1



User manual × 1



Warranty card
× 1



Troubleshooting
× 1

Carefully remove the cordless snow shovel and check to see that all of the above items are supplied.





 **NOTE:** Do not discard the shipping carton and packaging material until you are ready to use your new cordless snow shovel. (The packaging is made of recyclable materials.)

Properly dispose of these materials in accordance with local regulations.









IMPORTANT! The equipment and packaging material are not toys. Do not let children play with plastic film or bags, foil, or small parts. These items can block the airway and pose a suffocation risk!

SYMBOLS



	DANGER! Direct danger to life and risk of injury! Directly dangerous situation that may lead to death or severe injuries.
	WARNING! Probable danger to life and risk of injury! Generally dangerous situation that may lead to death or severe injuries.
	CAUTION! Risk of injury! Dangerous situation that may lead to injuries.
	NOTICE! Risk of damage to the device! Situation that may lead to property damage.
	Note: Information to help you better understand the processes involved.









These symbols identify the required personal protective equipment:

	Hand protection: protective chainsaw gloves
	Eye protection: wrap-around goggles/safety helmet with visor
	Ear protection: earplugs/earmuffs
	Head protection: safety helmet with visor
	Foot protection: safety shoes with gripping soles, steel toes, and leg protection
	Clothing: close-fitting work clothes

Explanation of Safety Symbols

The following table depicts and describes safety symbols that may appear on this product. Read, understand, and follow all instructions for the machine before attempting to assemble and operate it.

	<p>Read the instruction manual.</p> <p>The following warning symbols are to remind you of the safety precautions you should take when operating the snow shovel.</p>
	<p>Always keep children and pets away from the working area.</p> <p>Always stay clear of the working area. The ejected snow may hurt you.</p>

	<p>Keep hands away from the moving parts of the snow shovel. The rotating parts will hurt you.</p>
	<p>Keep feet away from the moving parts of the snow shovel. The rotating parts will hurt you.</p>
	<p>To reduce the risk of electric shock, disconnect from the power supply and replace a damaged cord immediately.</p>
	<p>Do not use hands to unclog the chute.</p>
	<p>Wear safety goggles and ear protection.</p>
	<p>Double-insulated for additional protection.</p>
	<p>Conforms to relevant safety standards.</p>
	<p>Defunct electrical products should not be disposed of with regular household waste. Please recycle where facilities exist. Check with your local authority or retailer for recycling advice.</p>

Environmental protection



CAUTION! This product shall not be discarded with household waste. Instead, it shall be disposed of in a collection system that conforms to the USEPA policy. Contact your local authorities or stockist for advice on recycling. The product will then be recycled or dismantled to reduce its impact on the environment. Electric and electronic equipment can be hazardous for the environment and to human health since such equipment contains hazardous substances.



IMPORTANT! All Operators Must Read These Instructions Before Use!

Read all instructions before using this cordless snow shovel. Basic safety precautions should always be followed to reduce the risk of fire, electric shock, and personal injury.

General Safety WARNINGS!

- You and any other operator of this snow shovel must read, understand, and follow these instructions in their entirety and should reread them at the start of each snow season. Failure to follow these instructions may result in **ELECTRIC SHOCK, FIRE, and/or serious PERSONAL INJURY.**

 **NOTICE! The personal safety alert symbol is used in this manual to draw your attention to a WARNING given along with the particular operating instruction. This means that the operation requires special ATTENTION, CAUTION, and AWARENESS.**

Keep work area clean and well lit: Cluttered, dark areas invite accidents.

- **Use the right product:** Do not use this machine for any job except that for which it is intended.
- **Replacement parts:** When servicing this unit, use only identical replacement parts. Replace or repair a damaged charger cord immediately. Do not use the snow shovel on gravel surfaces unless the shovel is adjusted for such surfaces in accordance with the operator's manual.
- **Keep children, bystanders, and pets away:** All spectators, including pets, should be kept a safe distance away from the work area.
- **Dress properly:** Do not wear loose or hanging clothing or jewelry. They can become caught in moving parts.
- Wear rubber boots. The cordless snow shovel should not be operated in the hand-held position except when the instructions provided in this manual deem such use permissible.
- **Avoid accidental starting:** Make sure the safety switch and the trigger switch are in the Off position before inserting the battery into the unit. Do not carry the cordless snow shovel with the safety switch and the trigger switch engaged.
- **Moving parts:** Keep hands and feet away from moving parts. Keep guards in place and in proper working order.
- **CAUTION!** Exercise caution to prevent yourself from slipping or falling. Wear protective footwear that protects your feet and improves your footing on slippery surfaces.
- **Use safety glasses:** Also use safety footwear, snug-fitting clothing, protective gloves, hearing protection, and head protection.
- **Stay alert:** Watch what you are doing. Use common sense. Do not operate the cordless snow shovel when you are tired or under the influence of alcohol or drugs.
- **Do not force the tool:** It will perform better, with less likelihood of personal or mechanical injury, if it is used at the rate for which it was designed.
- **Do not overreach:** Keep proper footing and balance at all times.
If the cordless snow shovel strikes a foreign object, follow these steps:
 1. Stop the cordless snow shovel.
 2. Remove the battery.
 3. Inspect the shovel for damage.
 4. Repair any damage before restarting and operating the snow shovel.
- **Disconnect the tool:** Turn off the power switch and remove the battery when it is not in use; before servicing it; when changing accessories; and when performing any other maintenance task.
- **Store idle tool indoors:** When not in use, the cordless snow shovel should be stored indoors in a dry, locked place out of the reach of children.
- **Maintain the cordless snow shovel with care:** Follow the applicable maintenance instructions for replacing parts and changing accessories. Lubrication is not required.



This is the safety alert symbol. It is used to alert you to potential personal injury hazards. Obey all safety messages that follow this symbol to prevent injury or death. Improperly using or maintaining this cordless snow shovel could result in injury or death. To reduce this potential, comply with the following safety instructions.

This cordless snow shovel can amputate hands and feet if used incorrectly. It can also pick up foreign objects, which can become dangerous projectiles when thrown into the air. Failure to observe the following safety instructions could result in serious personal injury.

Training

- Read, understand, and follow all instructions on the machine and in the manual before operating this unit. Thoroughly familiarize yourself with the controls and the proper use of the equipment. Know how to stop the unit and disengage the controls quickly.
- Children should never be allowed access to the equipment. Adults should never operate the equipment without carefully reading and understanding these instructions.
- Keep the area of operation clear of all persons, particularly small children and pets. Exercise caution to prevent slipping or falling.

Preparation

- Thoroughly inspect the area where the equipment is to be used. Remove all doormats, sleds, boards, wires, and other foreign objects.
- Do not operate the equipment without wearing adequate winter garments. Avoid loose-fitting clothing and accessories that can become caught in moving parts. Wear footwear that will improve your footing on slippery surfaces.
- Do not use the snow shovel on gravel surfaces unless the shovel is adjusted for such surfaces in accordance with the operator's manual.
- Never attempt to make any adjustments while the motor is running (except when specifically recommended by the manufacturer).
- Always wear safety glasses or eye shields during operation or while performing an adjustment or repair to protect your eyes from foreign objects that may be thrown from the machine.

Operation

- Do not put hands or feet near or under rotating parts. Keep clear of the discharge opening at all times.
- Do not use the snow shovel on gravel surfaces unless the shovel is adjusted for such surfaces in accordance with the operator's manual. Stay alert for hidden hazards or traffic.
- After striking a foreign object, stop the motor and remove the battery. Thoroughly inspect the cordless snow shovel for any damage. Repair the damage before restarting and operating the cordless snow shovel. Should the unit start to vibrate abnormally, again, remove the battery, stop the motor, and check the unit immediately to ascertain the cause. Vibration is generally a sign of trouble.
- Stop the motor and remove the battery whenever you leave the operating position; when transporting the unit; before unclogging the rotor blade housing; and when making any repairs, adjustments, or inspections to the unit.
- When cleaning, repairing, or inspecting the cordless snow shovel, make sure that all moving parts have come to a complete stop before proceeding. For your utmost safety, remove the battery.
- Exercise extreme caution when operating on slopes.
- Never operate the cordless snow shovel without proper guards and other safety devices in place and in proper working order.

- Never direct the discharge opening toward people or toward areas where property damage can occur. Keep children, pets, and other bystanders away from the work area.
- Do not overload the machine capacity by attempting to clear snow at too fast a rate.
- Look behind you and use care when backing up with the cordless snow shovel. Never operate the cordless snow shovel without good visibility or light. Always be sure of your footing and keep a firm hold on the handles.
- Walk, never run, with the unit.

| Clearing a Clogged Rotor Housing

Hand contact with the rotating blades inside the rotor housing is the most common cause of injury associated with cordless snow shovels. Never use your hands to clear a clogged rotor housing.

To clear the rotor housing:

- Shut the motor off and remove the battery.
- Wait 10 seconds to be sure the rotor blades have come to a complete stop.

Always use a clean-out tool, not your hands, to free the rotating blades.

| Maintenance and Storage

- Check all fasteners at frequent intervals for proper tightness to ensure that the equipment is in safe working condition.
- Always refer to the operator's manual for important details, such as how to properly store your cordless snow shovel for an extended period of time.
- Maintain or replace safety and instruction labels as needed.
- Run the machine for a few minutes after you finish clearing snow to prevent the rotor blades from freezing.

Battery and Charger Safety Instructions

 **IMPORTANT!** Analyses confirm that incorrect use and poor care of high-performance batteries are the main factors responsible for personal and/or product damage.

 **WARNING!** Use only approved replacement batteries; other batteries may damage the cordless snow shovel and cause it to malfunction, which can lead to serious personal injury.

 **WARNING!** Do not use a battery pack or appliance that is damaged or modified. Damaged or modified batteries may behave unpredictably, resulting in fire, explosion, or injury. Do not modify or attempt to repair the appliance or the battery pack except as indicated in the instructions for use and care. Have your battery pack serviced by a qualified repair person using only identical replacement parts. This will ensure that the safety of the battery pack is maintained.

 **CAUTION!** To reduce the risk of injury, charge the Voltask 20V lithium-ion battery pack only in its designated Voltask lithium-ion charger. Other types of chargers present a risk of fire, personal injury, and damage. Do not wire a battery pack to a power supply plug or car cigarette lighter. Such misuse will permanently disable or damage the battery pack.

- **Avoid dangerous environments.** Do not charge the battery pack in rain or snow, or in otherwise damp or wet locations. Do not use the battery pack or charger in explosive atmospheres (those containing gaseous fumes, dust, or flammable materials) because sparks may be generated when inserting or removing the battery pack, which could lead to a fire.
- **Charge in a well-ventilated area.** Do not block the charger vents. Keep them clear to allow for proper ventilation. Do not allow smoking or open flames near a charging battery pack. Vented gases may explode.

 **NOTE!** The safe temperature range for the battery is 41°F-105°F/5°C-40.5°C. Do not charge the battery outside in freezing weather; always charge it at room temperature.

- **Take care of the charger cord.** When unplugging the charger, pull the plug (not the cord) from the receptacle to reduce the risk of damage to the electrical plug and cord. Never carry the charger by its cord or yank it by the cord to disconnect it from the receptacle. Keep the cord away from heat, oil, and sharp edges. Make sure the cord will not be stepped on, tripped over, or subjected to damage or stress when the charger is in use. Do not use the charger with a damaged cord or plug. Replace a damaged charger immediately.
- **Do not use an extension cord unless it is absolutely necessary.** Using a wrong, damaged, or improperly wired extension cord poses a risk of fire and electric shock. If an extension cord must be used, plug the charger into a properly wired 16-gauge or larger extension cord with a socket that matches the plug on the charger. Make sure that the extension cord is in good electrical condition.
- **Charger is rated for 120V AC only.** The charger must be plugged into an appropriate receptacle.
- **Use only recommended attachments.** Use of an attachment not recommended or sold by the manufacturer of the battery charger or battery pack may result in fire, electric shock, or personal injury.
- **Unplug charger when not in use.** Make sure to remove battery packs from unplugged chargers.

 **WARNING!** To reduce the risk of electric shock, always unplug the charger before performing any cleaning or maintenance. Do not allow water to flow into the charger. Use a ground fault circuit interrupter (GFCI) to reduce shock hazards.

- **Do not burn or incinerate battery packs.** Battery packs may explode, causing personal injury or damage. Toxic fumes and materials are created when battery packs are burned.
- **Do not crush, drop, or damage battery packs.** Do not use the battery pack or charger if it has sustained a sharp blow, been dropped or run over, or been damaged in any way (e.g., pierced with a nail, hit with a hammer, or stepped on).
- **Do not disassemble.** Incorrect reassembly poses a serious risk of electric shock, fire, and/or exposure to toxic battery chemicals.
- **Battery chemicals cause serious burns.** Never let a damaged battery pack contact the skin, eyes, or mouth. If a damaged battery pack leaks battery chemicals, use rubber or neoprene gloves to safely dispose of the pack. If skin is exposed to battery fluids, wash the affected area with soap and water, and rinse with vinegar. If eyes are exposed to battery chemicals, immediately flush with water for 20 minutes and seek medical attention. Remove and dispose of contaminated clothing.
- **Do not short-circuit.** A battery pack will short-circuit if a metal object makes a connection between the positive and negative contacts on the battery pack. Do not place a battery pack near anything that may cause a short circuit, such as paper clips, coins, keys, screws, nails, and other metallic objects. A short-circuited battery pack poses a risk of fire and severe personal injury.
- **Store your battery pack and charger in a cool, dry place.** Do not store the battery pack or charger where temperatures may exceed 105 °F /40.5 °C, such as in direct sunlight or inside a vehicle or metal building during the summer.

Information About the Battery

1. The battery pack supplied with your cordless snow shovel is only partially charged. The battery pack has to be charged completely before you use the tool for the first time.
2. For optimum battery performance, avoid low discharge cycles by charging the battery pack frequently.
3. Store the battery pack in a cool place—ideally at 77 °F /25 °C—and charged to at least 40%.
4. Lithium-ion batteries are subject to a natural aging process. The battery pack must be replaced no later than when its capacity falls to 80% of its capacity when new. Weakened cells in an aged battery pack are no longer capable of meeting the high-power requirements needed for the proper operation of your snow shovel and therefore pose a safety risk.
5. Do not throw battery packs into an open fire, as this poses a risk of explosion.
6. Do not ignite the battery pack or expose it to fire.
7. Do not exhaustively discharge batteries. Exhaustive discharge will damage the battery cells. The most common cause of exhaustive discharge is lengthy storage or disuse of partially discharged batteries. Stop working as soon as the performance of the battery falls noticeably or the electronic protection system triggers. Place the battery pack in storage only after it has been fully charged.
8. Protect batteries and the tool from overloads. Overloads will quickly result in overheating and cell damage inside the battery housing, even if this overheating is not apparent externally.
9. Prevent damage and shocks. Immediately replace batteries that have been dropped from a height of more than 1 yd. or those that have been exposed to violent shocks, even if the housing of the battery pack appears to be undamaged. The battery cells inside the battery may have suffered serious damage. In such instances, please read the waste disposal information for proper battery disposal.
10. If the battery pack suffers overloading and overheating, the integrated protective cutoff will switch off the equipment for safety reasons.
11. Use only original battery packs. The use of other batteries poses a fire risk and may result in injuries or an explosion.

Information About the Charger and the Charging Process

1. Please check the data marked on the rating plate of the battery charger. Be sure to connect the battery charger to a power supply with the same voltage marked on the rating plate. Never connect the charger to a different voltage.
2. Protect the battery charger and its cord from damage. Keep the charger and its cord away from heat, oil, and sharp edges.
3. Electrical plugs must match the socket. Never modify the plug in any way. Do not use any adapter plugs with grounded appliances. Unmodified plugs and matching sockets will reduce the risk of electric shock.
4. Keep the battery charger, battery pack(s), and cordless tool itself out of the reach of children.
5. Do not use the supplied battery charger to charge other Voltask cordless tools unless indicated as compatible by the manufacturer.
6. During periods of heavy use, the battery pack will become warm. Allow the battery pack to cool to room temperature before inserting it into the charger to recharge.
7. Do not overcharge batteries. Do not exceed the maximum charging times. These charging times apply only to discharged batteries. Frequent insertion of a charged or partially charged battery pack will result in overcharging and cell damage. Do not leave batteries in the charger for days on end.
8. Never use or charge batteries if you suspect that it has been more than 12 months since the last time they were charged. There is a high probability that the battery pack has already suffered serious and dangerous damage (exhaustive discharge).
9. Charging batteries at a temperature below 41 °F / 5 °C will cause chemical damage to the cells and may cause a fire.
10. Do not use batteries that have been exposed to heat during the charging process because the battery cells may have suffered dangerous damage.
11. Do not use batteries that have suffered curvature or deformation during the charging process or those that exhibit other atypical symptoms (gassing, hissing, cracking, etc.).
12. Never fully discharge the battery pack (maximum recommended depth of discharge is 80%). A complete discharge of the battery pack will lead to premature aging of the battery cells.

Protection From Environmental Influences

1. Wear suitable work clothes and safety goggles.
2. Protect your cordless tool and the battery charger from moisture and rain, both of which can cause dangerous cell damage.
3. Do not use the cordless tool or the battery charger near vapors and flammable liquids.
4. Do not keep the battery charger in places where the temperature is liable to reach over 105 °F / 40.5 °C. In particular, do not leave the battery charger in a car that is parked in direct sunlight.
5. Protect batteries from overheating. Overloads, overcharging, and exposure to direct sunlight will result in overheating and cell damage. Never charge or work with batteries that have been overheated; replace them as soon as possible.
6. Store the charger and your cordless tool only in dry locations with an ambient temperature of 41 °F – 105 °F / 5 °C – 40.5 °C. Store your lithium-ion battery pack in a cool, dry place at a temperature of 77 °F / 25 °C. Protect the battery pack, charger, and cordless tool from humidity and direct sunlight. Store only batteries that have been charged to at least 40%.
7. Prevent the lithium-ion battery pack from freezing. Battery packs that have been stored below 32 °F / 0 °C for more than 60 minutes must be discarded.

Proper Care of Battery and Charger



WARNING! To reduce the risk of injury, always unplug the charger and remove the battery pack from the charger before performing any maintenance task.

1. To reduce the risk of injury and damage, never immerse your battery pack or charger in liquid or allow any liquid to flow inside these components.
2. Clean out dust and debris from charger vents and electrical contacts by blowing with compressed air.
3. Use only mild soap on a damp cloth to clean the battery pack and charger, keeping away from all electrical contacts. Certain cleaning agents and solvents are harmful to plastics and other insulated parts. Some of these harmful substances include gasoline, turpentine, lacquer thinner, paint thinner, chlorinated cleaning solvents, ammonia, and household detergents containing ammonia. Never use flammable or combustible solvents around battery packs, battery chargers, or tools.
4. The lithium-ion battery charger has no serviceable parts.

Off-Season Storage of Battery and Charger

- a. Do not expose your battery pack or charger to water or rain, or otherwise allow these items to get wet. Wetness could permanently damage the charger and the battery pack. Do not use oil or solvents to clean or lubricate your battery pack as these substances can cause the plastic casing to become brittle and crack, posing a serious risk of injury.
- b. Store the battery pack and charger at room temperature away from moisture. Do not store these items in damp locations, where corrosion of terminals may occur. As with other battery pack types, permanent capacity loss can result if the pack is stored for long periods at high temperatures (above 105°F/40.5 °C).

Proper Dispose of Battery and Charger

Always dispose of your battery pack according to federal, state, and local regulations. Search online and/or contact a recycling agency in your area to find a suitable location for recycling the battery pack.



CAUTION! Even discharged battery packs contain some energy. Before disposing of them, cover the terminals with electrical tape to prevent shorting, which could cause a fire or explosion.



WARNING! To reduce the risk of injury or explosion, never burn or incinerate a battery pack—even if it is damaged, dead, or completely discharged. When batteries burn, they emit toxic fumes and materials into the atmosphere.

1. Batteries vary according to device. Consult your manual for specific information.
2. Install only new batteries of the same type in your product (where applicable).
3. Failure to insert batteries in the correct polarity, as indicated in the battery compartment or manual, may shorten the life of the batteries or cause batteries to leak.
4. Do not mix old and new batteries.
5. Do not dispose of batteries in a fire or incinerator.
6. Batteries should be recycled or disposed of as per state and local guidelines.

Battery Pack Recycling

To preserve our natural resources, please recycle or dispose of batteries properly. The batteries charged by this charger may contain chemicals and metals that are harmful to the environment. Never dispose of rechargeable batteries in your normal household garbage or in landfill sites because to do so will unnecessarily pollute the environment.

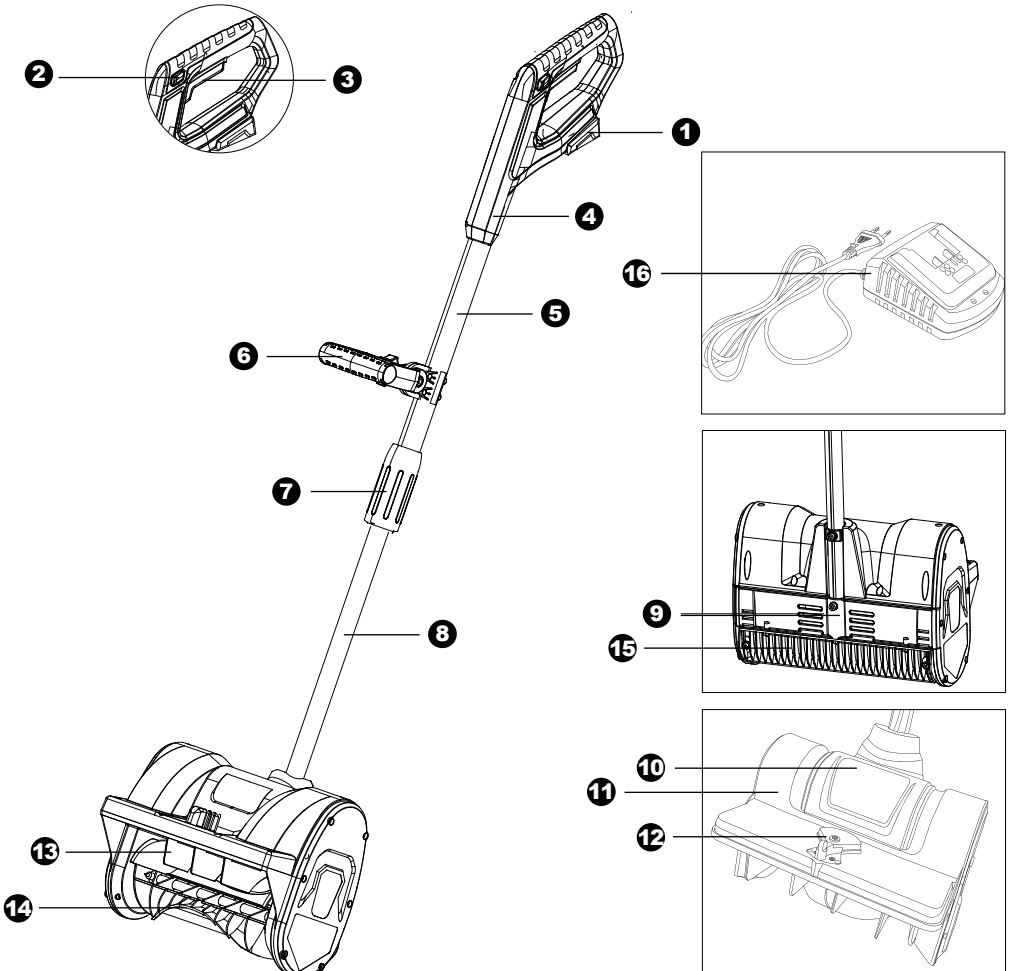

Fig. 1

- ① 20V/4Ah battery
- ② Safety lock switch
- ③ Trigger switch
- ④ Handle
- ⑤ Upper tube
- ⑥ Auxiliary handle
- ⑦ Lock knob
- ⑧ Lower tube

- ⑨ Tube cover
- ⑩ Motor housing
- ⑪ Machine casing
- ⑫ Angle-adjustment knob
- ⑬ Snow guide plate
- ⑭ Shovel blade
- ⑮ Scraper blade
- ⑯ Battery charger

Assembling the Main Shaft

Slide the upper shaft into the lower shaft assembly. Align the screw holes (Fig. 2).

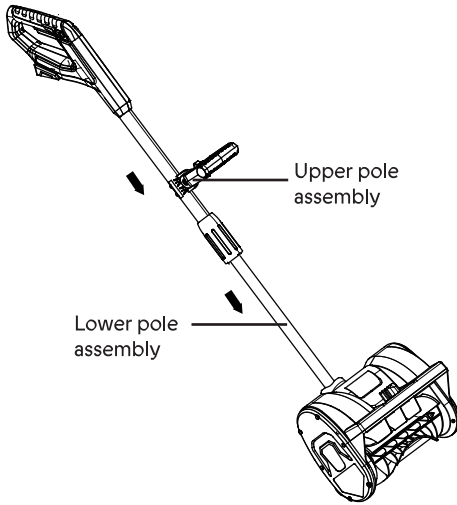

Fig. 2

Insert the joint-fixing knob through the aligned holes in the shafts and secure the other end with the washers and the joint-fixing knob (Fig. 3).

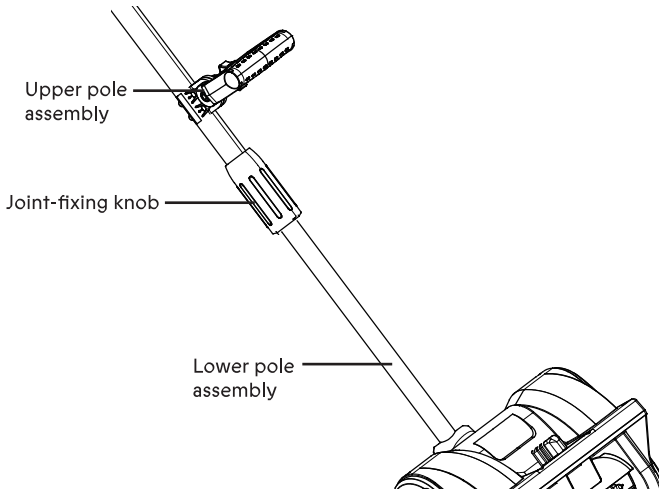

Fig. 3

Charging the Battery

1. Press the push-lock buttons on the battery to pull the battery pack out of the equipment. (Fig.4)

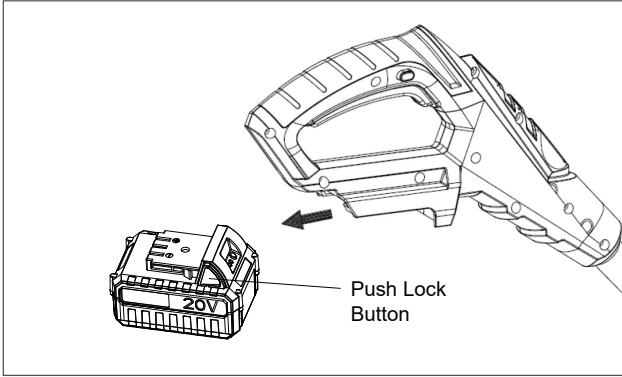





Fig. 4

2. The battery pack is equipped with a push button for checking the charge level. Simply press the button and read the battery indicator as follows:

Lights	Light Indicators
	<p>The battery is at 30% capacity and needs to be charged.</p>
	<p>The battery is at 60% capacity and will need to be charged soon.</p>
	<p>The battery is at full capacity.</p>
	<p>Charge level button</p>

NOTE: If the charge level button does not appear to be working, insert the battery into the charger and charge as needed.

NOTE: Immediately after using the battery pack, the charge level button may display a lower charge than it will if checked a few minutes later. The battery cells "recover" some of their charge after resting

3. Check that the voltage of the electrical outlet is the same as that marked on the rating plate of the battery charger. Then, insert the charger's plug into the wall outlet. When you plug in the charger, the green light at the top right will illuminate and stay green. (Fig.5)

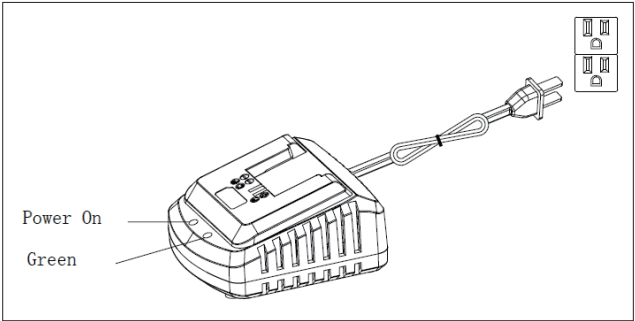

Fig. 5

4. Place the battery pack into the charger by sliding the pack to lock it into position. When you insert the battery into the charger, the green light at the top right will go off and the red light at the top left will illuminate to indicate that the battery is charging. (Fig.6)

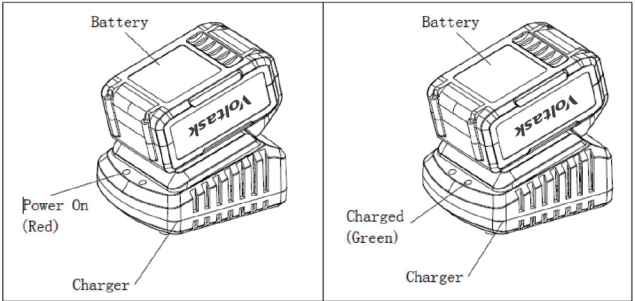



Fig. 6

5. When the charger light turns green, the battery is fully charged.

 **NOTE:** A fully discharged pack with an internal temperature in the normal range will fully charge in 2 hr. 20 min. (between 32°F/0°C and 113°F/45°C).

6. If the light indicators do not come on at all, check that the battery pack is fully seated into the bay. Remove the battery pack and reinsert it. If the problem persists, please contact Voltask for support and service.

7. When charging is complete, remove the battery from the charger by pressing the push-lock button and sliding the battery backward to unlock it from the charger. (Fig.7)

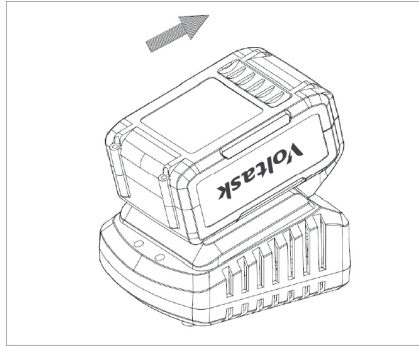



Fig. 7

8. Timely recharging of the battery will help prolong the battery's life. You must recharge the battery pack when you notice a drop in the equipment's power.



IMPORTANT! Never allow the battery pack to become fully discharged as this will cause irreversible damage to the battery.

 **WARNING!** Keep the area to be cleared free of stones, toys, and other foreign objects that the rotor blades might pick up and throw. Such items could be covered by snow and are easy to overlook, so be sure to conduct a thorough inspection of the area before beginning work.

Starting and Stopping the Machine

1. Slide the battery into the battery compartment until it clicks to lock it into position (Fig.8).

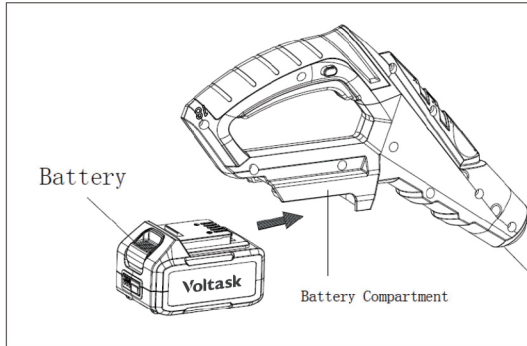

Fig. 8

2. To start the cordless snow shovel, push and hold the safety lock switch on the side of the handle with your thumb. Then, squeeze the trigger switch with your fingers. Once the machine powers on, you can release the safety lock switch and proceed with operation. (Fig.9)

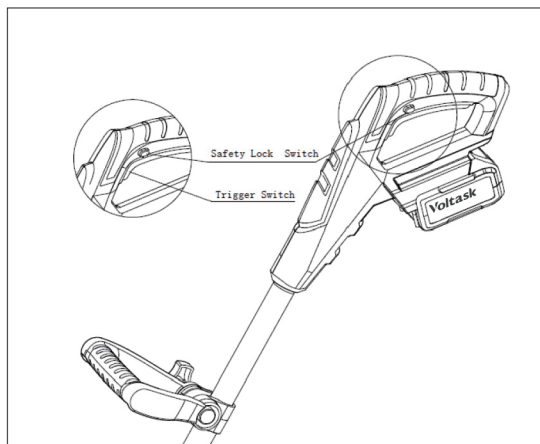

Fig. 9

3. To stop the cordless snow shovel, release the trigger switch.

Handle Adjustment

To adjust the angle of the auxiliary handle, follow the instructions below:

1. Stop the machine and remove the battery. Wait until the blade comes to a complete stop.
2. Loosen the auxiliary handle by turning the handle knob counterclockwise. Rotate the auxiliary handle to a comfortable position. (Fig.10).

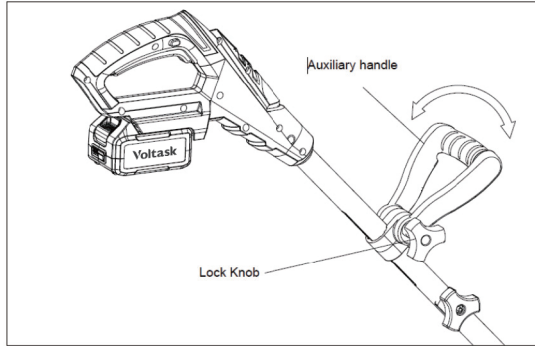

Fig. 10

3. Fix the handle by tightening the knob. Insert the battery and resume working.

To adjust the position of the auxiliary handle, follow the instructions below:

1. Stop the machine and remove the battery. Wait until the blade comes to a complete stop.
2. Loosen the handle knob slightly and adjust the auxiliary handle as needed to the desired position. Retighten the handle knob securely.

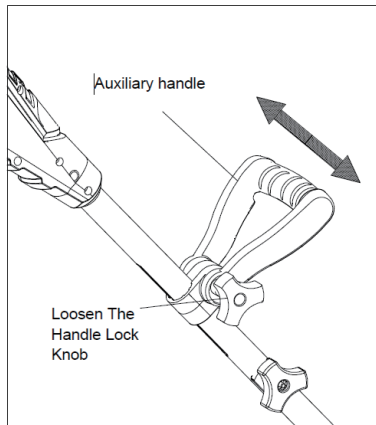

Fig. 11

3. Insert the battery and resume working.

NOTE: In order to prevent the auxiliary handle from moving around or sliding on the pole, be sure to tighten it securely.

Angle Adjustment

WARNING! Don't adjust the angle when the machine is running. If you want to adjust the angle, please stop the machine first. When you adjust the angle, please check the picture below.

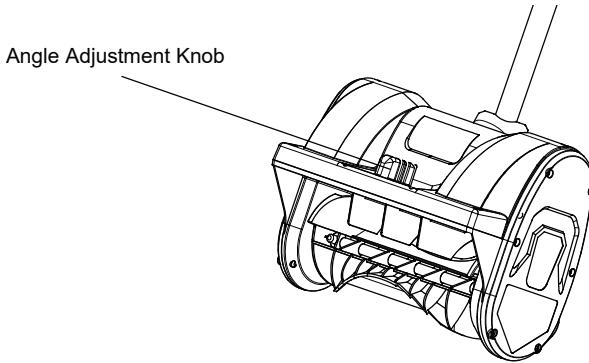

Fig. 12

If you turn the knob to the right, the snow guide plate will turn to the left. If you want to turn the snow guide plate to the right, please turn the knob to the left.

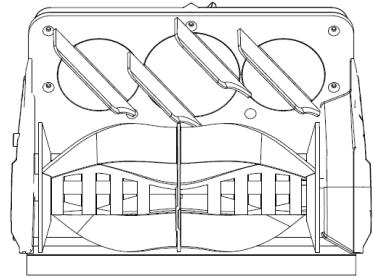
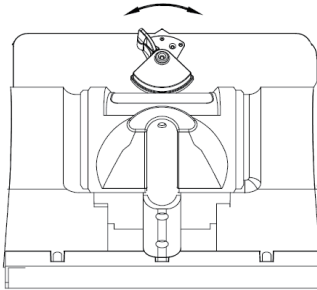

Fig. 13

Operating Tips

1. Start the cordless snow shovel. Push the shovel forward at a rate that is comfortable yet slow enough to clear the path completely. The clearing width of the snow shovel and the depth of snowfall should dictate your forward speed.
2. Direct the snow discharge to the right or to the left by holding the cordless snow shovel at a slight angle.
3. To remove snow most efficiently, throw the snow downwind and slightly overlap each swath.
4. Do not use the snow shovel on gravel surfaces unless the shovel is adjusted for such surfaces in accordance with the operator's manual.
5. This cordless snow shovel cuts a path 11 in. (28 cm) wide and up to 6 in. (15 cm) deep in one pass.
6. When clearing deeper drifts, hold the cordless snow shovel by the upper and auxiliary handles, and use a swinging or sweeping motion. Remove up to 6 in. (15 cm) of snow with each pass. Repeat as many times as needed.
7. Remove the battery after using the cordless snow shovel. Hang the shovel so it will not be knocked or damaged.

WARNING! When servicing, use only identical replacement parts. Use of any other parts may create a hazard or cause product damage. To ensure safety and reliability, all repairs should be performed by a qualified service technician.

WARNING! To prevent serious personal injury, remove the battery pack from the tool before servicing, cleaning, changing add-on attachments or removing material from the unit.

WARNING! For the user's safety, worn or damaged parts must be replaced. Replace with original replacement parts only.

Cleaning

- Regular cleaning and maintenance of your snow shovel will ensure efficiency and prolong the life of the product.
- After each use, take apart and clean out the ice and debris from the ventilator and its slots, the auger, and the scraper blade.
- Your snow shovel requires no additional lubrication.
- Wipe clean with a soft, water-soaked cloth and a soft brush. Never spray water onto the machine or otherwise wet or immerse the machine.
- Do not use detergents or solvents as these could cause irreparable damage to the snow shovel. Chemicals can destroy plastic parts.

Clearing a Clogged Auger

Hand contact with the rotating auger inside the motor housing is the most common cause of injury associated with cordless snow shovels. Never use your hands to clear a clogged auger.

To clear the auger:

- Shut the motor off and remove the battery.
- Wait 10 seconds to be sure the auger has come to a complete stop.
- Always use a clean-out tool, not your hands, to free the auger.

Replacing the Drive Belt



IMPORTANT! Make sure to turn off the machine and remove the battery before performing any maintenance task on your cordless snow shovel.

1. Remove screws and take off the cover.
2. Remove the screw, washer, pulley frame, and belt from the pulleys.
3. Install the new belt in the same groove as the old one.
4. Replace the screw, washer, and pulley frame.
5. Replace the cover and secure it with screws.

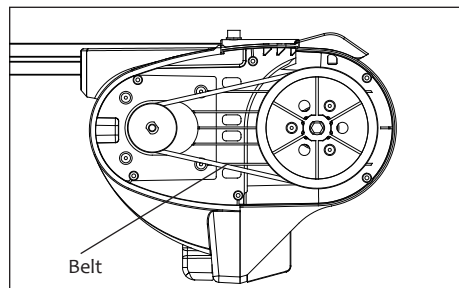
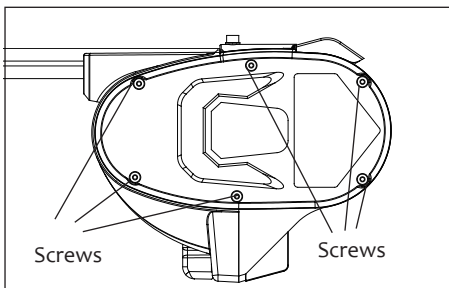

Replacing the Scraper Blade



IMPORTANT! Make sure to turn off the machine and remove the battery before performing any maintenance task on your cordless snow shovel.

1. Place the snow shovel on the ground or on a workbench. Position the snow shovel so that the impeller is facing up.
2. Use a screwdriver to remove the screws beneath the impeller, which secure the scraper to the housing.
3. Remove the scraper and discard it in the proper manner.
4. Snap the new scraper into position and attach it to the snow shovel by reinstalling the screws.

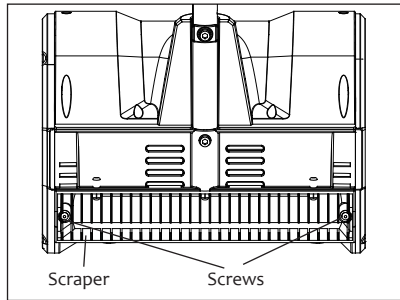

Storage

- a. Examine the cordless snow shovel thoroughly for worn, loose, or damaged parts. Should you need to repair or replace a part, contact Voltask customer service for assistance.
- b. Remove the battery from the cordless snow shovel before storing the shovel.
- c. Allow the shovel to dry thoroughly.
- d. To protect the snow shovel from corrosion when storing for long periods, lightly oil the metal parts.
- e. Store the cordless snow shovel indoors in a locked, dry, well-ventilated place out of the reach of children to prevent unauthorized use or damage.

OPTIONAL ACCESSORIES

SS-20E

⚠ WARNING! ALWAYS use only authorized Voltask replacement parts and accessories. NEVER use replacement parts or accessories that are not intended for use with this cordless snow shovel. Contact Voltask if you are unsure whether it is safe to use a particular replacement part or accessory with your cordless snow shovel. The use of any other attachment or accessory can be dangerous and could cause injury or mechanical damage.

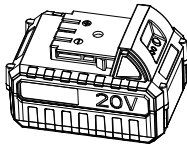
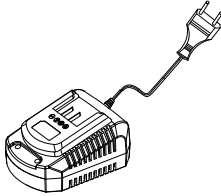
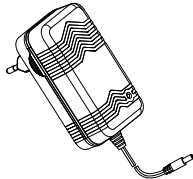
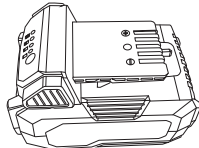
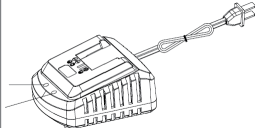
Product	Item	SKU
	 <p>20V+4.0 Ah Lithium-Ion Battery <i>Battery Charge Time Max:</i> C-20:2h CD-20: 2h 40m</p>	B-20-4
SS-20E SS-20C SS-20E SS-40A SS-40B	 <p>20V (2.2A) Quick Charger</p>	C-20
	 <p>20V (1.5A) Charger</p>	CD-20
SS-20D	 <p>20V+4.0 Ah Lithium-Ion Battery <i>Battery Charge Time Max:</i> DY-C-20:2h</p>	DY-B-20-4
	 <p>20V (2.4A) Quick Charger</p>	DY-C-20

When Something Isn't Working

 **DANGER! Risk of injury!** Improperly performed repairs can lead to the device not functioning safely. This can endanger yourself and the environment.

Problem	Possible Cause	Solution
• Snow shovel does not start.	• Battery not installed well	• Make sure the battery is fully inserted.
	• Battery depleted	• Charge the battery.
	• Lock-off button not depressed	• Depress the lock-off button fully and then squeeze the On/Off switch.
	• Battery too cold	• Remove battery from snow shovel. Place battery on charger and allow to charge for 10 minutes. Remove from charger and install in snow shovel for use.
• Poor performance	• Drive belt worn or damaged	• Contact the service center for replacing.
	• Auger worn or damaged	• Contact the service center for replacing.
	• Discharge blocked	• Switch off the snow shovel, remove the battery pack, and clean the discharge.
• Abnormal vibrations	• Drive belt worn or damaged	• Contact the service center for replacing.
	• Auger worn or damaged	• Contact the service center for replacing.
	• Scraper blade worn	• Replace the scraper blade.
• Motor is on but auger does not turn.	• Driver belt damaged	• Contact the service center for replacing.
• Snow shovel leaves a thin layer of snow.	• Scraper blade worn	• Replace the scraper blade.

WARRANTY

3-year limited warranty on Voltask equipment

Voltask warrants to the original owner that each new product and service part is free from defects in materials and workmanship.

Voltask agrees to repair or replace any defective product or part for the warranty period as stated above from the original date of purchase, except for the conditions and circumstances listed below:

1. This warranty applies only to the original purchaser at retail and may not be transferred.
2. Warranty applies if the product is used for personal, household, or family use.
3. Warranty is void if the product is used for commercial, industrial, or rental purposes.
4. Warranty does not include repairs due to the operator's abuse or negligence (including overloading the product beyond capacity or immersion in water), or the failure to assemble, operate, maintain, or store the product according to the instructions in the owner's manual.
5. This warranty is not transferable and applies only to products sold directly from an authorized retailer. This warranty does not apply to any product, new or used, purchased through unauthorized third-party channels.
6. Any incidental, indirect, or consequential loss, damage, or expense that may result from any defect, failure, or malfunction of the product is not covered by the warranty.
7. Products sold damaged or incomplete, sold "as is," or sold as reconditioned are not covered under the warranty.
8. Damage or liability caused by shipping, improper handling, improper assembly, incorrect voltage, improper wiring, improper maintenance, improper modification, or the use of accessories and/or attachments not specifically recommended is not covered by this warranty.
9. Expendable items that become worn during normal use are not covered by the warranty.
10. Warranty does not cover damage caused by cold, heat, rain, excessive humidity, corrosive environments and materials, or other contaminants.
11. Warranty does not include installation, assembly, or normal adjustments explained in the owner's manual.
12. The expense of delivering the product to the vendor and the expense of returning the product or replacement parts to the owner is not covered by the warranty.
13. The warranty does not cover the normal deterioration of the exterior finish, including but not limited to scratches, dents, paint chips, or any corrosion or discoloration caused by heat, abrasive cleaners, and chemical cleaners.

Proof of purchase must accompany all warranty claims.

