

Lockheed Playpen Square

Assembly Guide

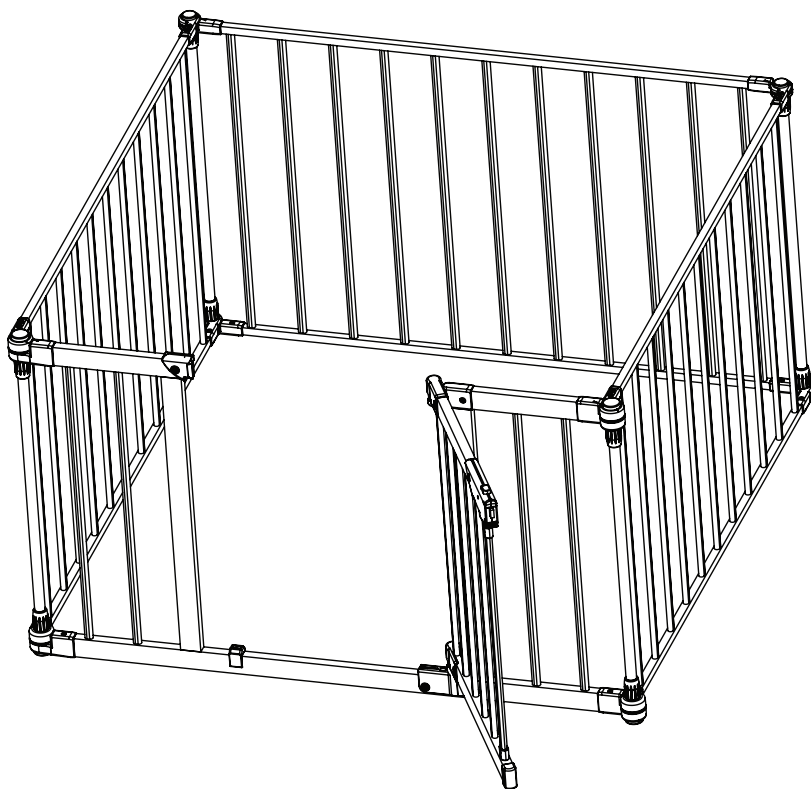

IMPORTANT
WARNINGS
ON BACK



ASSEMBLY LEVEL



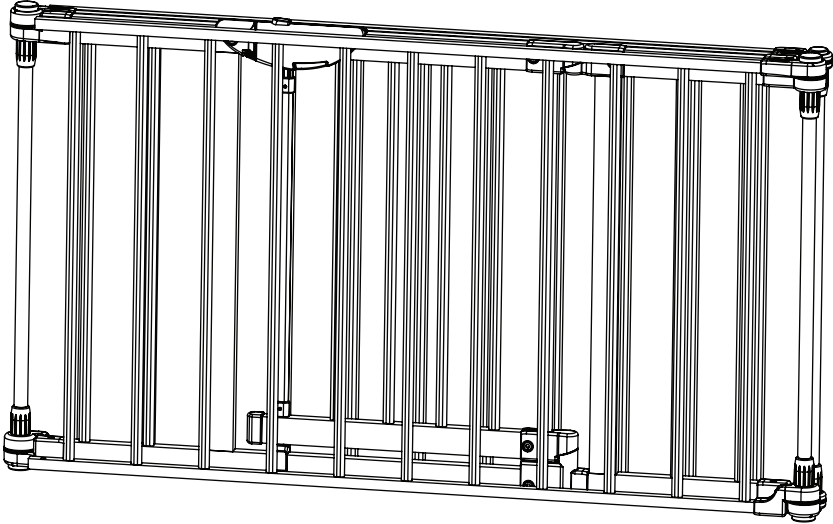

x 1

x 1

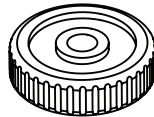

x 4

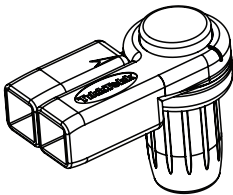

x 2

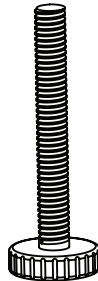

x 4

1.

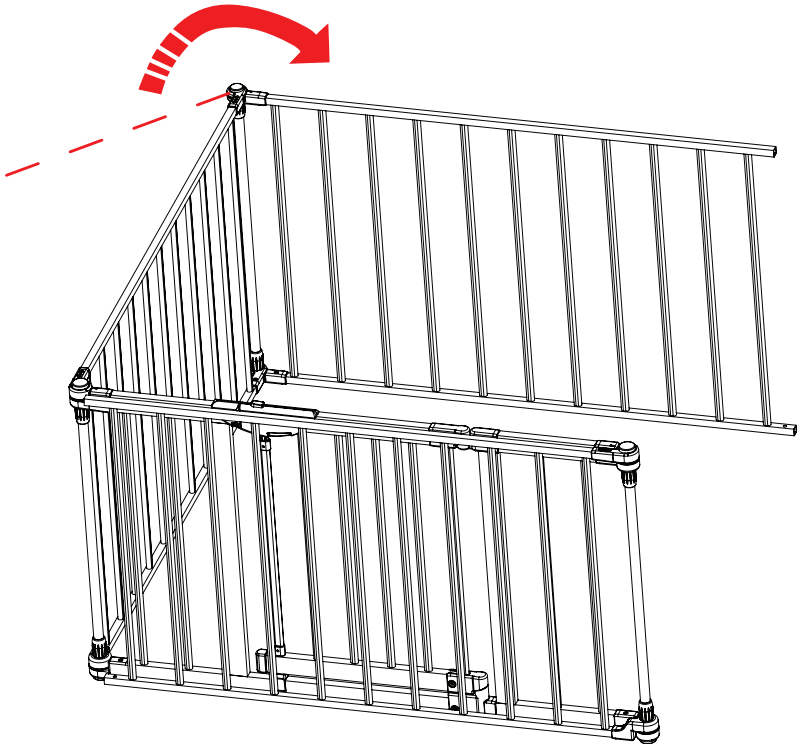
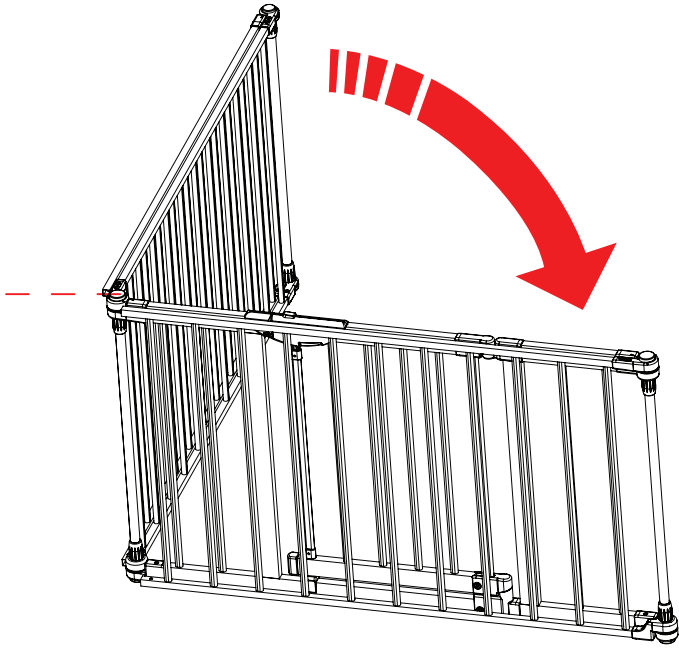

2.

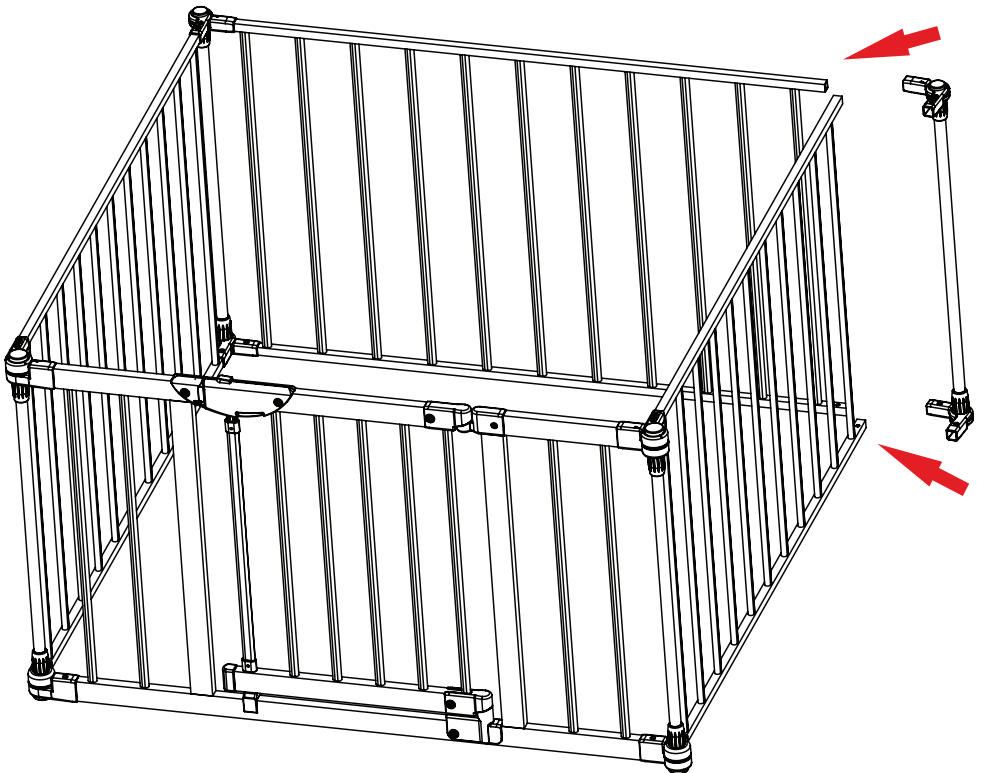
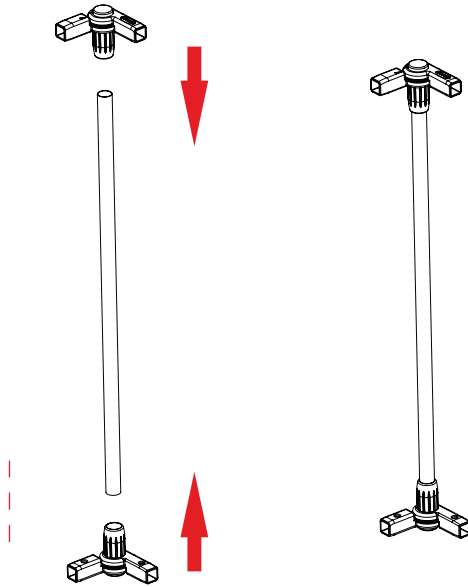

3.

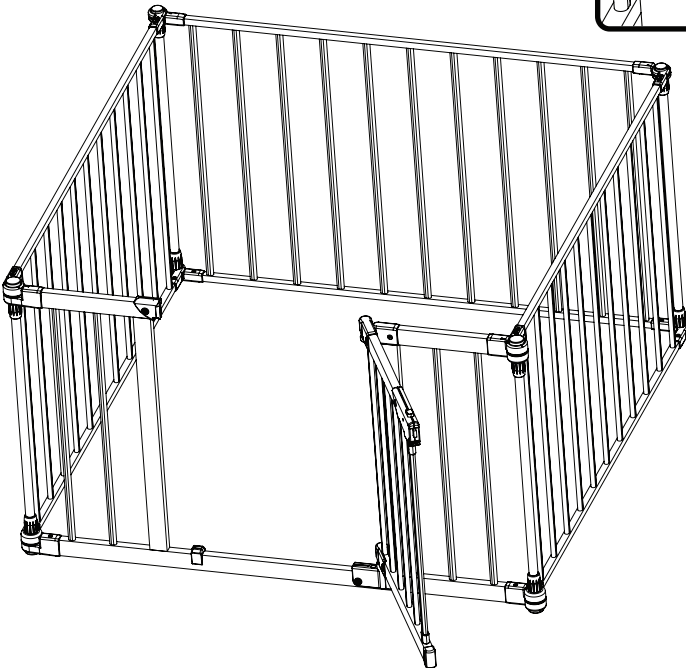
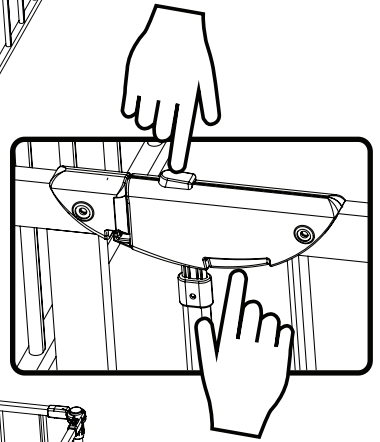
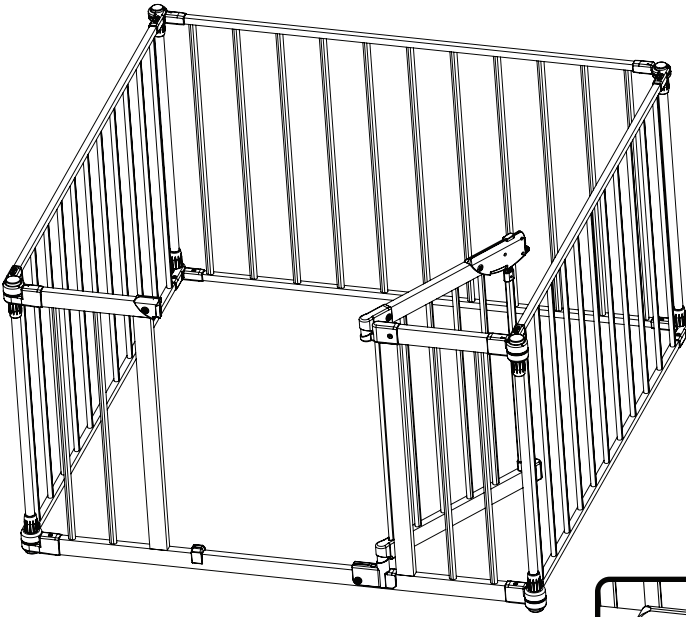

4.

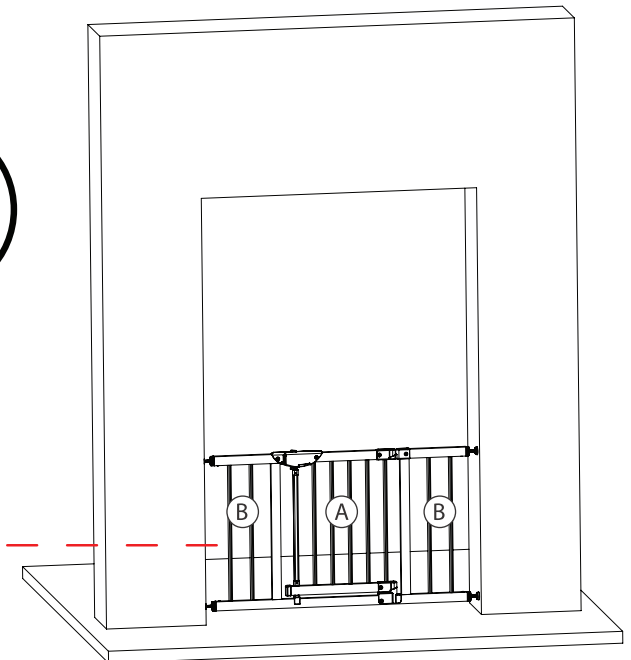
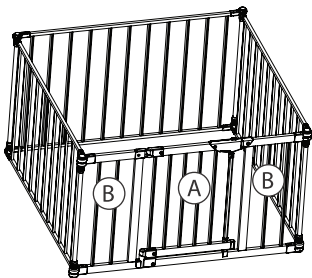
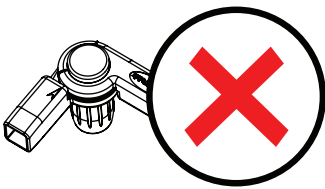
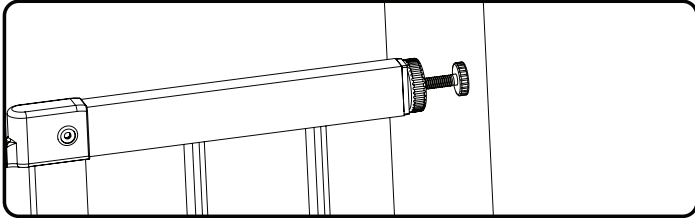
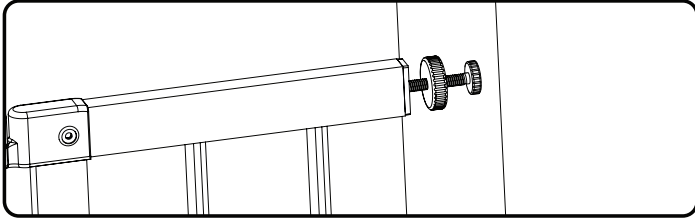
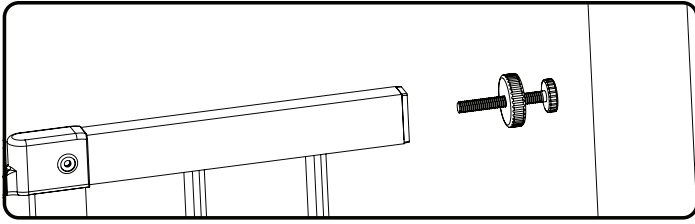

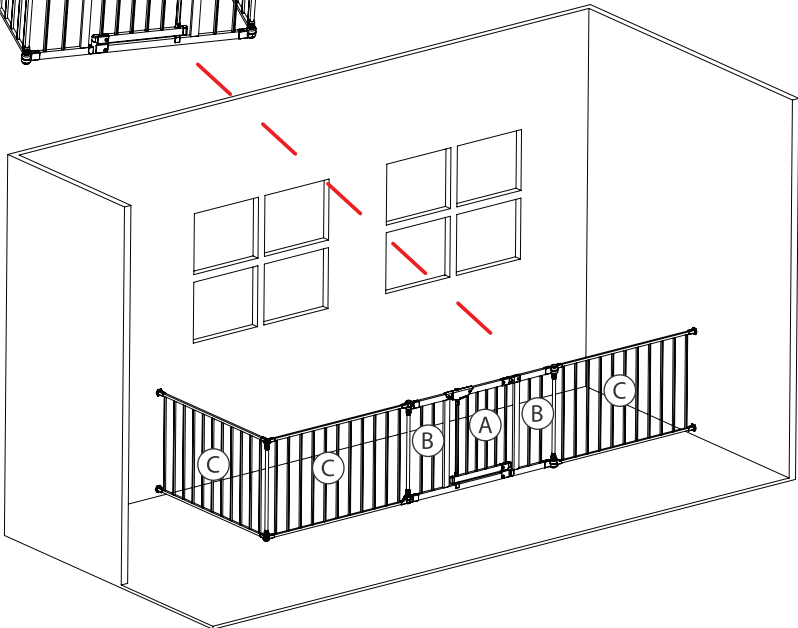
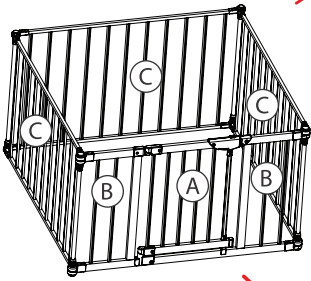
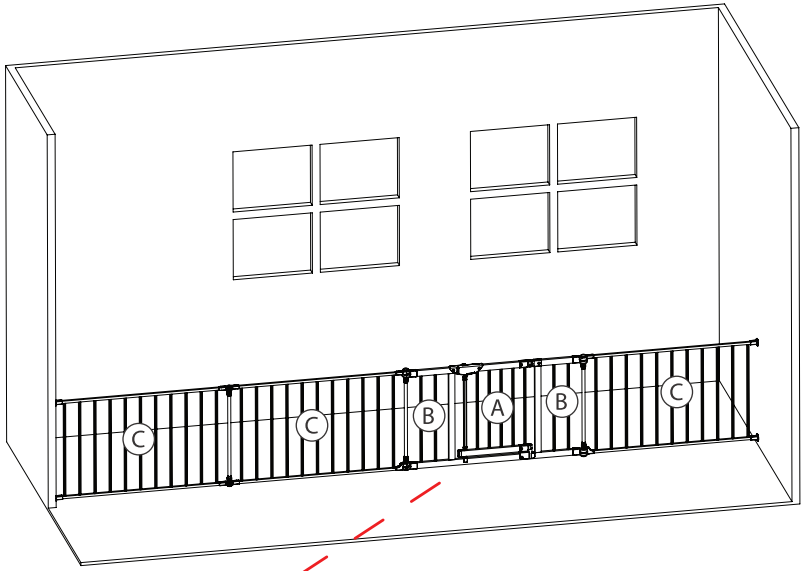

WARNING



This is not a safety device
DO NOT LEAVE CHILDREN UNATTENDED
DO NOT use as a barrier for stoves or heaters
Barrier use; Ensure that you confirm that barrier is very firmly fixed & intalled correctly. Barrier may not prevent older children from climbing over, there for parental supervision is required at all times
Incorrect installation may result in insability & weakness
Keep plastic bags away from children

PRODUCT NOTICE



The finish deteriorates if over exposed to the elements especially bright colours such as red
Wipe only with a dry or slightly damp cloth

SAFETY FEATURES



Certified toxin free
More stable due to stronger joints
Designed & compliant with the strict AUSSPASS standards

EXPORTER

TikkTokk HONG KONG
Weijiatun, Ligezhuang Town
Jiaozhou, Qingdao
266316, Shandong Province
China

CONSUMER ASSISTANCE

HOTLINE: +61 (0) 2 9980 6633
SKYPE: tikktokk.mb
EMAIL: info@tikktokk.com
WEB: www.tikktokk.com
ADDRESS: Unit 3, 280 New Line Rd
Dural, NSW, 2158,
Australia

IMPORTER

TikkTokk Australia
Unit 3, 280 New Line Rd
Dural, NSW, 2158
Australia