

Little BOSS Cot

Assembly Guide

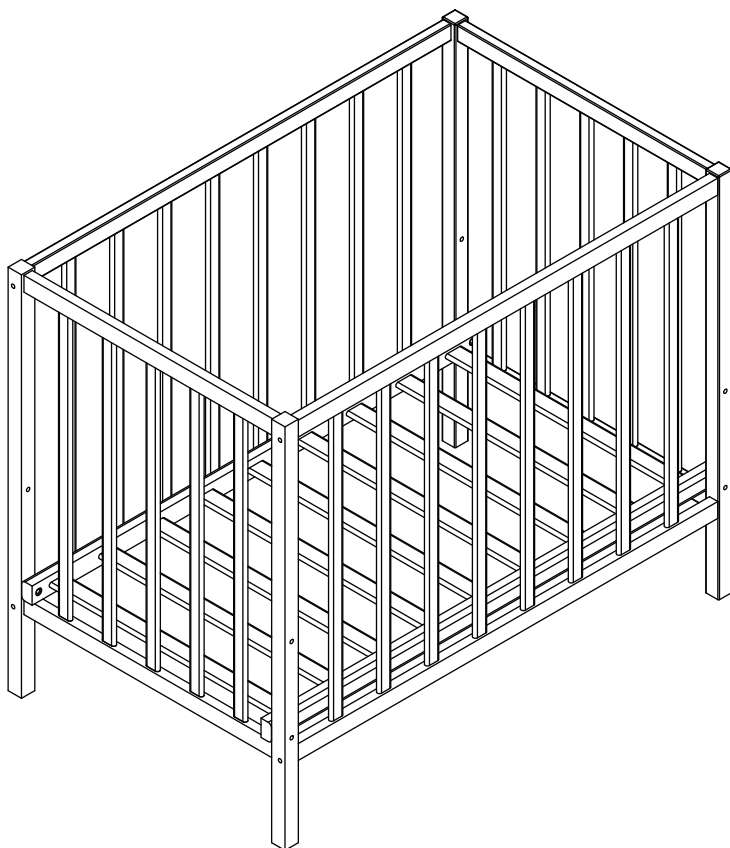

IMPORTANT
WARNINGS
ON BACK



ASSEMBLY LEVEL



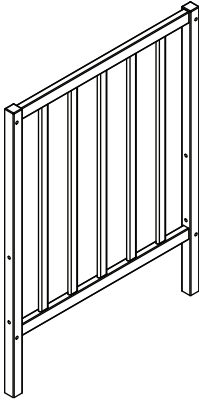

x 2

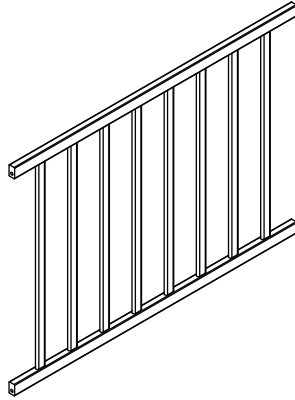

x 2

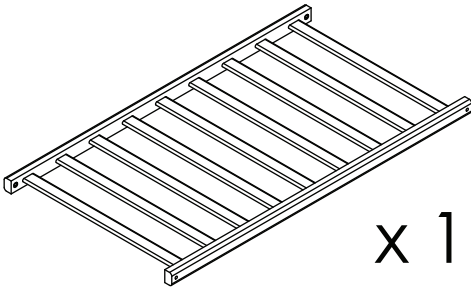

x 1

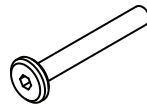

x 8

(A)

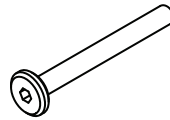

x 4

(B)

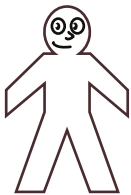

+

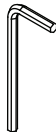

x 4

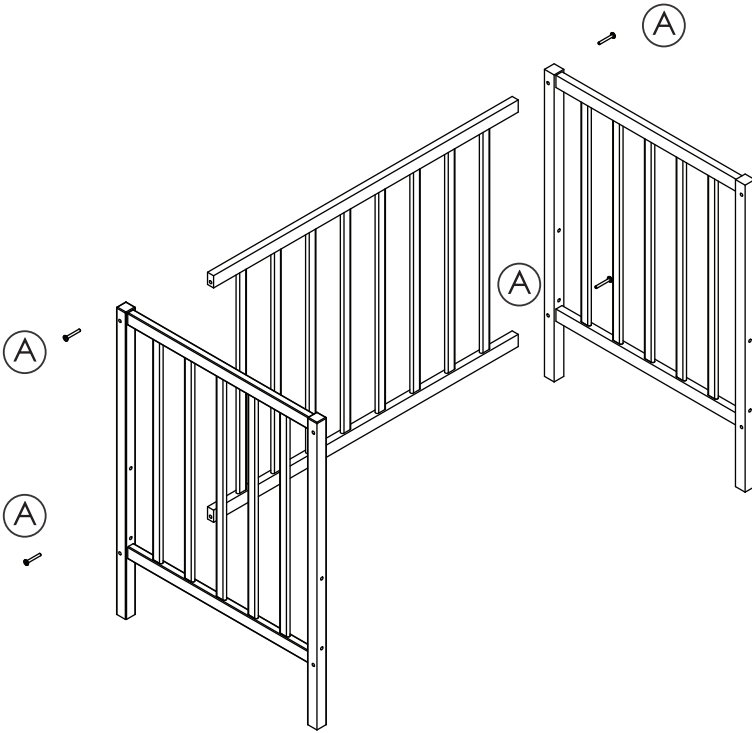

1.

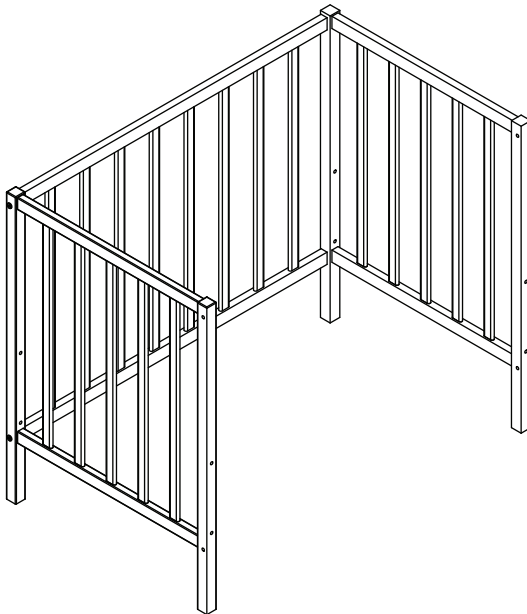

2.

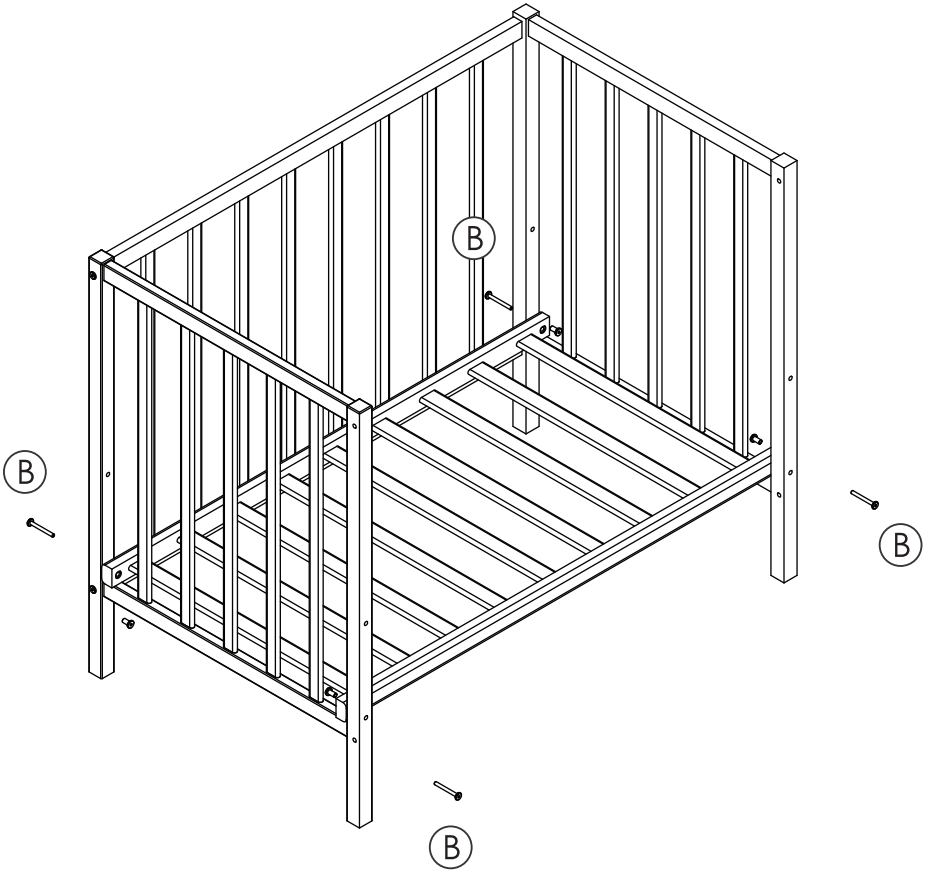

3.

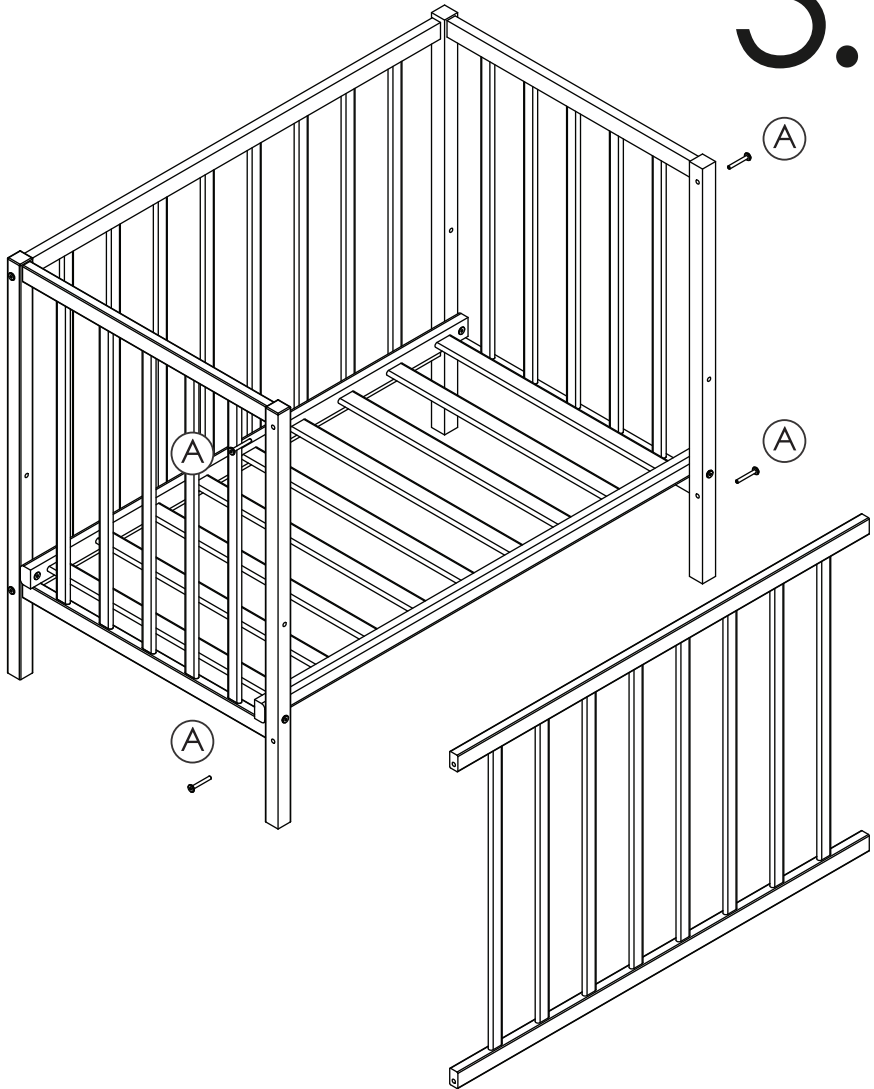

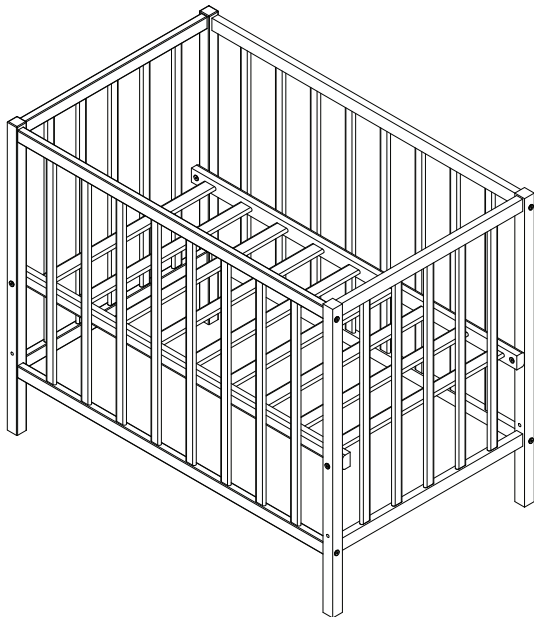
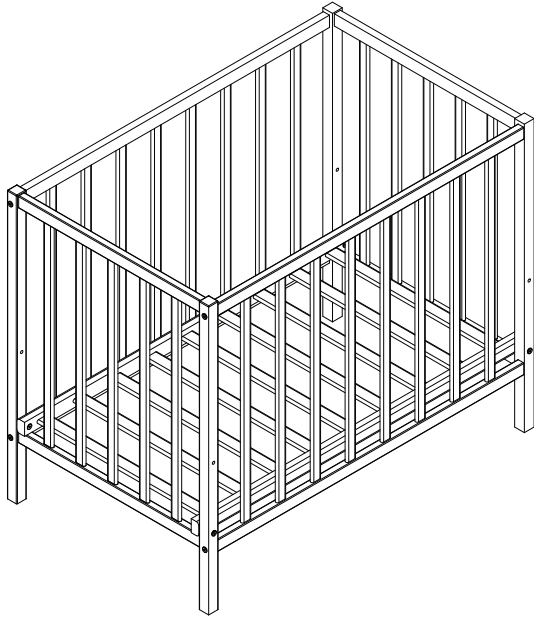



Warranty Registration - Register Your TikkTokk Product Online

Here's what you need:

- Receipt
- Date of Purchase
(on your receipt)

www.tikktokk.com

WARNING



KEEP THIS DOCUMENT FOR FUTURE REFERENCE

This is not a safety device

DO NOT LEAVE CHILDREN UNATTENDED

RECOMMENDED MATTRESS SIZE: This cot has been manufactured for use with a mattress which measures 770 wide x 1320 long x 120mm in thickness. The width & length are specified because it is important that the gaps between the mattress & the sides & ends of the cot will not exceed 40mm when the mattress is pushed to one side or end, and 20mm when the mattress is centred in the cot. The thickness of the mattress has been specified to ensure that the depth of the cot is greater than 500mm with the mattress base in the lower position to maximise the risk of a child climbing or falling out of the cot.

TO PREVENT FALLS the mattress base of this cot should be adjusted to the lowest position before the child can sit up.

Maximum mattress thickness should not exceed 120mm

Keep clean of all foreign substances including those that may be toxic

Manufacturer's assembly instructions must be followed in detail to ensure the safety features of the cot are not compromised

Incorrect installation may result in instability & weakness

Ensure that the cot is kept at a safe distance from curtains / blinds, heaters & power outlets.

Also ensure that medication, string, elastics, small toys & other small items such as money are kept out of reach from any position in the cot

Keep plastic bags away from children

Do not use the cot if any parts are broken, torn or missing

PRODUCT NOTICE



All screws should be checked & tightened regularly

Ensure the mattress is SIDS tested

All TikkTakk products are tested to the available standard

Assemble all components only according to TikkTakk's guidelines herein

SAFETY FEATURES



Certified toxin free

More stable due to stronger joints

Designed & compliant with the strict AUSSPASS standards

Product Code LBCT21

- Australian Standards (AS/NZS 2172:2013 & TPA 1974 no.6) Safety Approved Test Report: QDHL17020009110T

EXPORTER

TikkTakk HONG KONG
Weijiatun, Ligezhong Town
Jiaozhou, Qingdao 266316
Shandong Province
China

CONSUMER ASSISTANCE

HOTLINE: +61 (0) 2 9980 6633
SKYPE: tikktokk.mb
EMAIL: info@tikktokk.com
WEB: www.tikktokk.com
ADDRESS: Unit 3, 280 New Line Rd
Dural, NSW, 2158,
Australia

IMPORTER

TikkTakk Australia
Unit 3, 280 New Line Rd
Dural, NSW, 2158
Australia