

Door Barrier SML / MED / LGE

Assembly Guide

SML SIZE

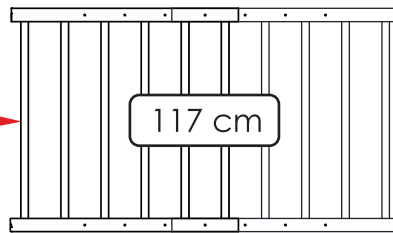
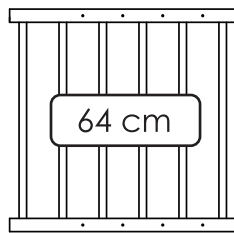

MED SIZE

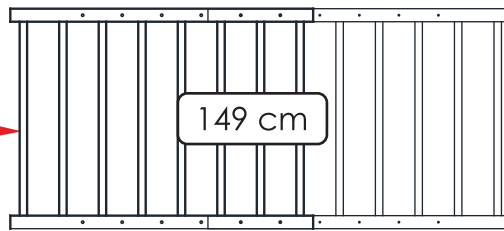
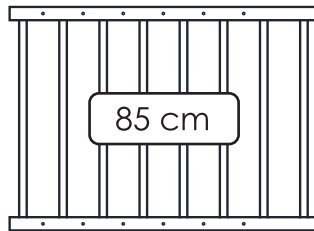

LGE SIZE

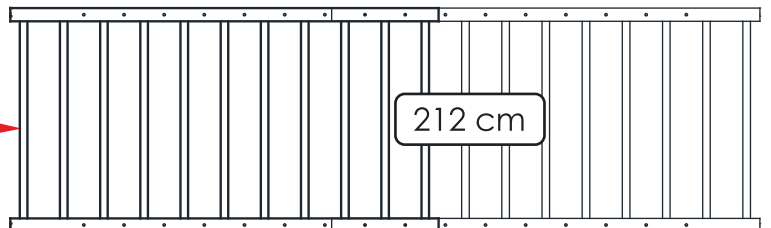
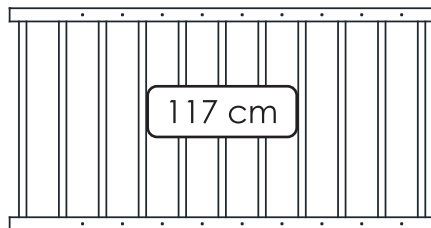

IMPORTANT
WARNINGS
ON BACK



ASSEMBLY LEVEL



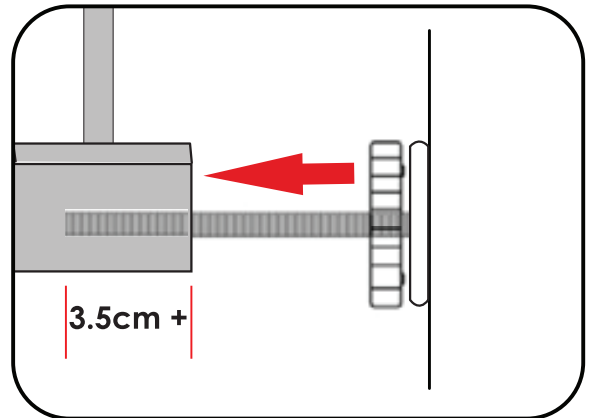
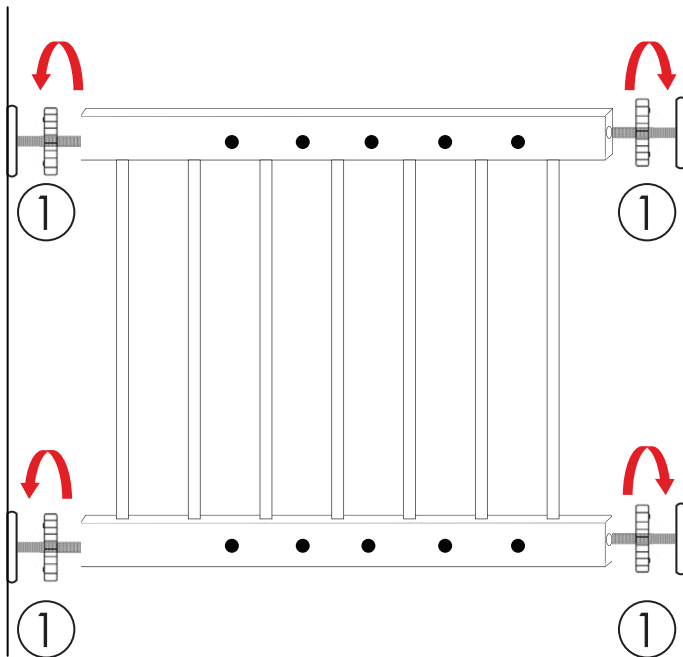
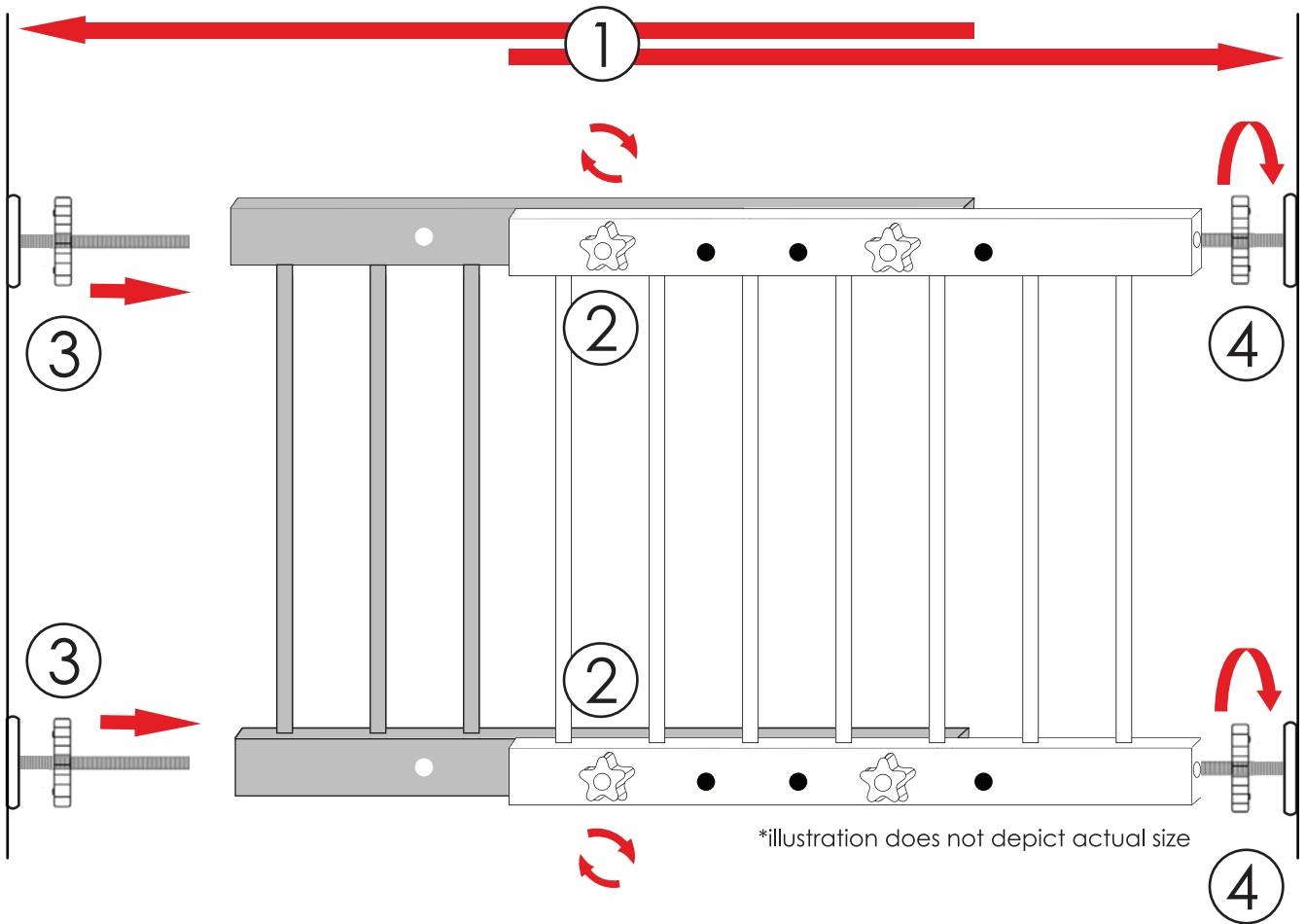

WARNING	
	<p>This is not a safety device DO NOT LEAVE CHILDREN UNATTENDED DO NOT use as a barrier for stoves or heaters Ensure that you confirm that barrier is very firmly fixed & installed correctly. Barrier may not prevent older children from climbing over, therefore parental supervision is required at all times Incorrect installation may result in instability & weakness Keep plastic bags away from children</p>

EXPORTER
 TikTokk HONG KONG
 Weijiatun, Ligezhong Town
 Jiaozhou, Qingdao 266316
 Shangdong Province, China
 Shandong China

CONSUMER ASSISTANCE
 HOTLINE: +61 (0) 2 9980 6633
 SKYPE: tiktokk.mb
 EMAIL: info@tiktokk.com
 WEB: www.tiktokk.com
 ADDRESS: Unit 3, 280 New Line Rd,
 Dural, NSW, 2158,
 Australia

IMPORTER
 TikTokk Australia
 Unit 3, 280 New Line Rd
 Dural, NSW, 2158
 Australia