

WARNING

It is forbidden to disassemble, squeeze, puncture, short-circuit this product or put it into the water, fire or expose it to an environment where the temperature is higher than 60°C (140°F).

Important Notes

The data measured by the FIAR Smart Body Fat Scale is for reference only and is not intended as medical advice.

The following groups of people may not have accurate physical data:

- Minors, elderly population over 80 years old.
- Professional athletes.
- Pregnant women and women in the puerperium.
- Patients with colds and fevers.
- People with medical devices such as pacemakers in their bodies are prohibited from using this product.

Daily precautions:

- 1、 This product uses No. 7 dry batteries and should be placed away from heat sources (heaters, stoves, fireplaces, etc.).
- 2、 The product is not waterproof. Please avoid direct rinsing with water to avoid damage.
- 3、 Do not disassemble or repair this product without permission if a malfunction occurs, and incorrect maintenance may cause the battery to explode.
- 4、 The physically weak people, elderly, children, and other people in need must use it safely under the guidance or assistance of the person who has responsibility for their safety.
- 5、 Do not place this product in a place where young children can reach it. Young children should be supervised to ensure that they do not play with the product.
- 6、 Please use a dry cloth to wipe the product if it has stains, Please do not use any detergent.

Precautions for daily use:

- 1、 This product uses four No. 7 dry batteries. Please remove the batteries after use to avoid battery power loss to maximize battery life.
- 2、 Before using this product, please keep the scale surface dry and free of water droplets, because using the scale in wet conditions will make it easy to slip.
- 3、 When weighing, please place the scale on a hard surface, not on a carpet or soft object.
- 4、 After use, keep the scale on a level surface and store it in a cool, dry place. Please carry it gently to avoid damage to the internal components by collision or strong impact.

Product Information

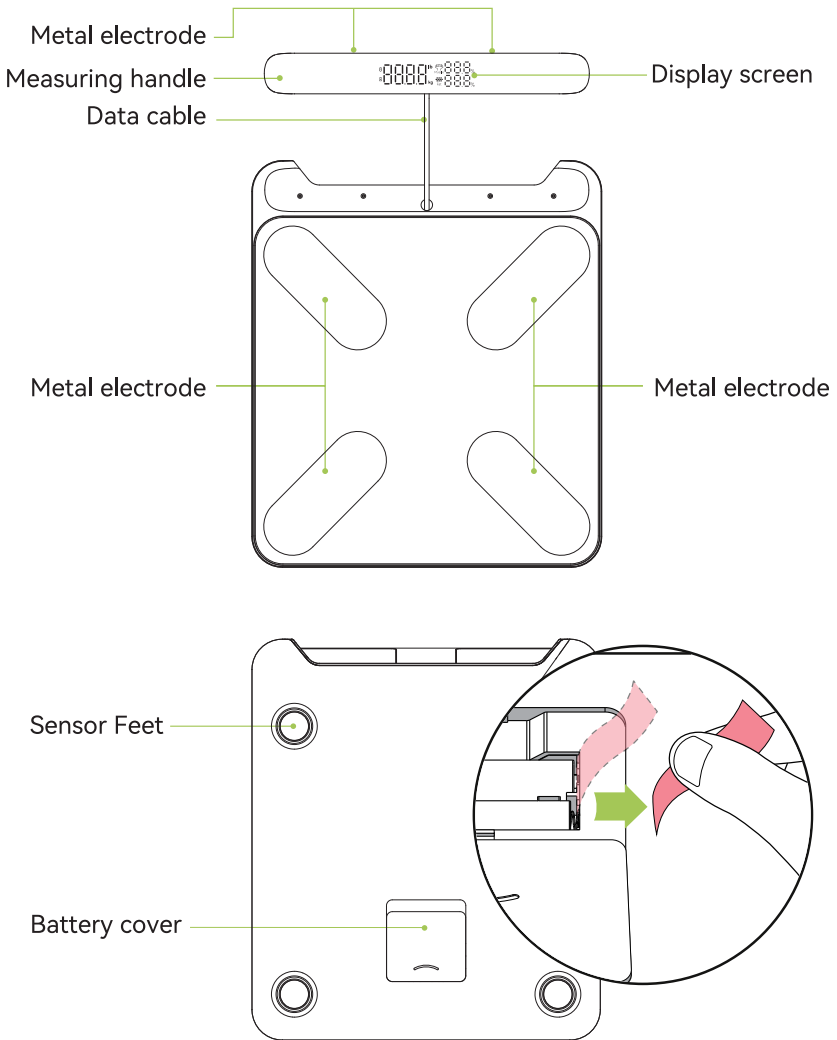

Precautions:

1. Please use it after withdrawing the insulating sheet. (As shown in the picture above)
2. This product is pressure-sensitive booting. The screen will light up and turn on after the scale is placed on a hard and flat surface.
3. When assembling the battery, please install the battery according to the positive and negative instructions before using it.

Installation of Fitdays APP

Search for "Fitdays" in the Android App Store or Apple App Store, or scan the QR code below to download and install the Fitdays client to connect to your device.

Before connecting Fitdays to your smart body fat scale, please make sure your device meets the following requirements:

The iPhone with IOS 8.0 or above

The mobile with Android 5.0 and above and equipped with Bluetooth 4.0



Turn on Fitdays and turn on Bluetooth for your phone

Turn on the Bluetooth option on your cell phone, and open Fitdays App to automatically connect with your device. Get on the scale and measure, then you can synchronize the data to the mobile app in real-time and record.

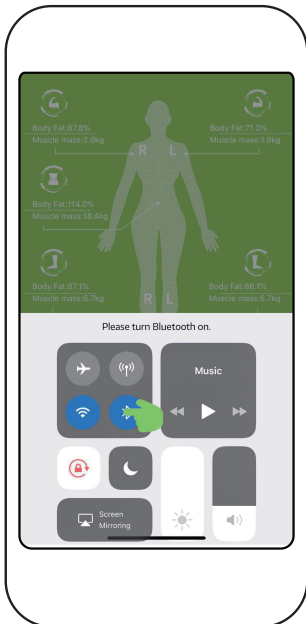

iOS Bluetooth on: open the control center, and click [Bluetooth icon].

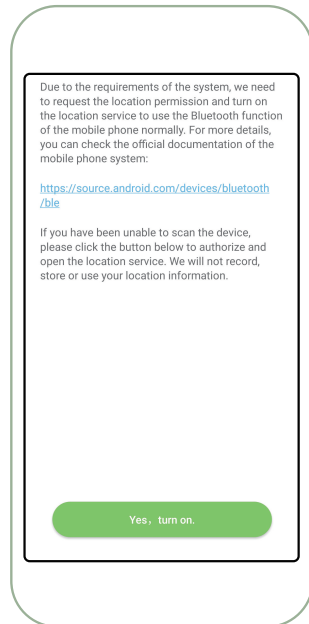

Android Bluetooth on: open Fitdays, and click [Allow] after the Bluetooth pop-up window appears.

Using the equipment

1. Before measurement, please load four No. 7 batteries into the battery warehouse according to the correct positive and negative electrodes. Gently step on the scale so that the scale screen lights up (as shown below), and make sure that the cell phone Bluetooth and GPS positioning are enabled.

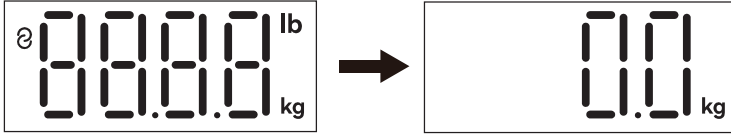

2. Use APP. Go to the home page and log in/register. For the first time use, please set the correct personal parameters for the current user.

3. If the current App has previously bound other devices and you want the App to add this new device, you can click [Account] - [Device] at the bottom right, and click [+] at the top right corner to enter the bound device interface. When the App searches for the device, click the body fat scale, then the binding is successful.

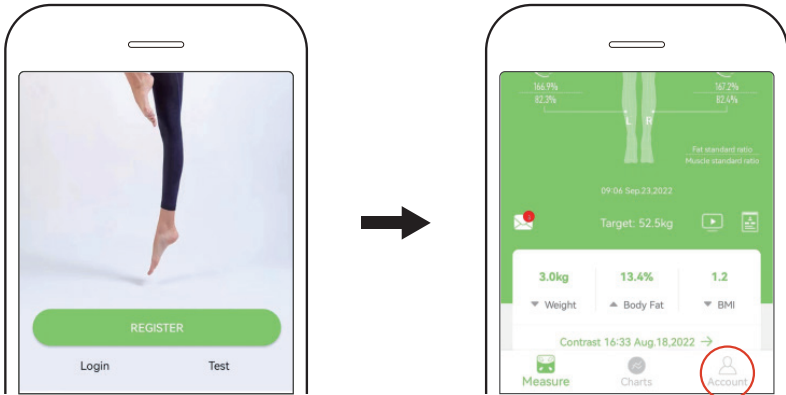

Precautions

- To ensure the accuracy of the data, please complete the measurement with the soles of the feet dry and clean. Please wear light clothing, keep your feet bare and keep your thumbs and fingers in close contact with the electrodes of the handle, open your hands at a 45° angle to your body, stand up straight with your legs apart, and keep your feet and hands in contact with the metal electrodes. Wait for the Fitdays App to indicate that the measurement is complete before dismounting the scale.
- Keep still while measuring. Do not move your feet or leave the scale.
- Please measure at the same time of day and under the same conditions. (This is more accurate)
- Do not measure after strenuous exercise, bathing, heavy drinking, or eating to avoid affecting the measurement results.
- Please do not use the product in a humid environment such as a bathroom or washroom to keep the product dry.
- Please operate the product according to the usage method recommended in this manual.

Keep your arms straight 45 degrees or 90 degrees

Arms close to waist

Arms not straight

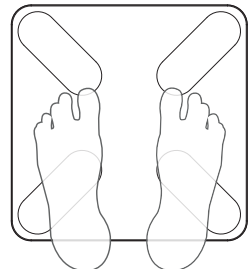
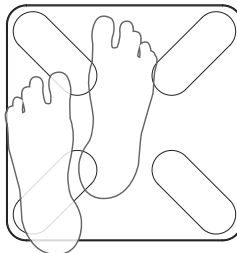
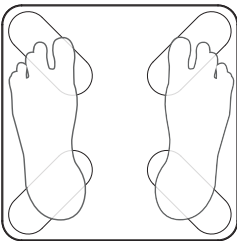
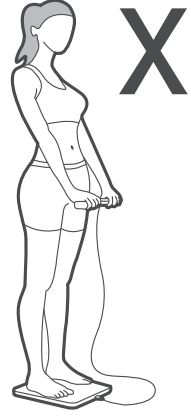
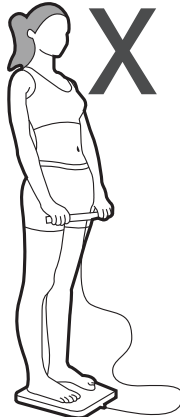
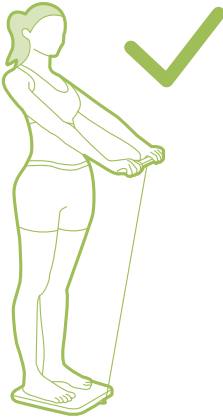



The tail finger does not touch the electrode pad



Two thumbs close together

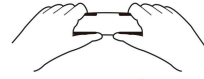

Keep your all fingers touch the electrode pads

Fitdays App

With Fitdays App, you can not only record your weight change, exercise consumption, diet intake, and other basic information but also check body data comprehensively through Smart Body Fat Scale, make intelligent analyses in the cloud, feedback health reports, and improvement suggestions.

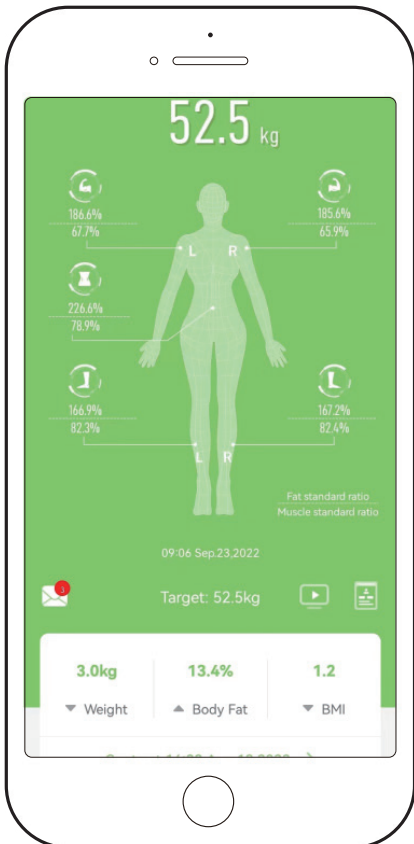

Fitdays measurement interface

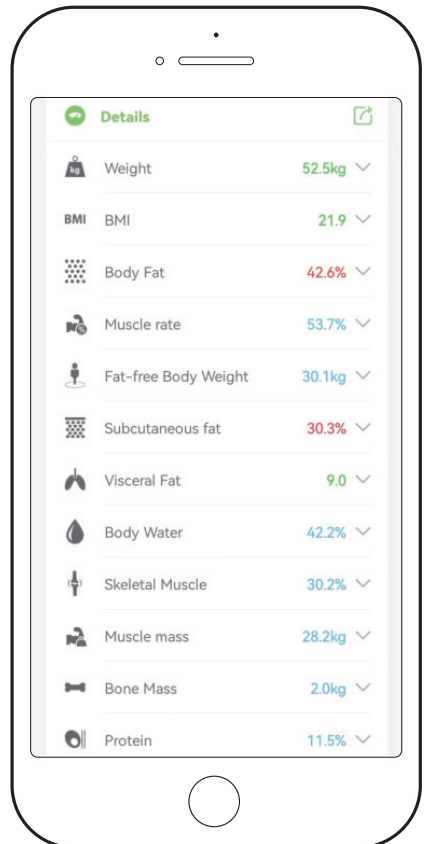

More than 20 data

Display Screen

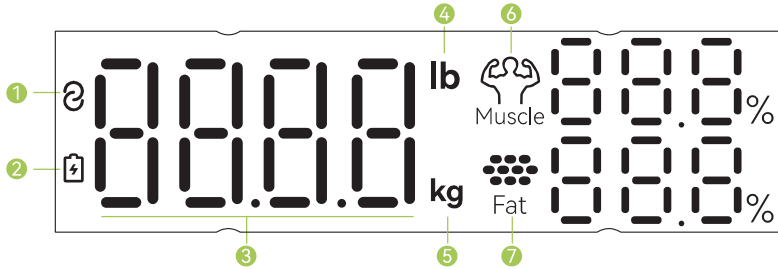

- ① Connective Symbol
- ② Battery Symbol
- ③ Body Weight
- ④ lb
- ⑤ kg
- ⑥ Muscle Rate
- ⑦ Fat Rate

Quick Guide for Use

1. Install the battery or tear off the insulating sheet to turn it on, put the scale on the flat ground, and press the scale until the display lights up,, then you can get on the scale to measure.

Note: (If the scale body and cell phone App are not connected, the connection symbol will not appear)

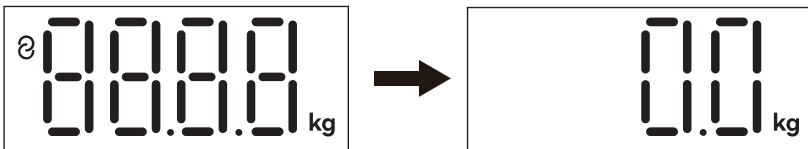

2. The product is turned on by pressure sensing. Get on the scale and weigh, the weight value will be locked after flashing three times. Then it will enter the state of body fat measurement. When the indicator light keeps running, it means that the product is in the process of fat measurement. Please do not get off the scale or release the handle when the indicator light is running, so as not to distort the measurement data. The measurement process is shown in the figure below.



3. After the measurement is complete, the locked weight value will be displayed, and the measurement data will be synchronized to the App display. The scale will automatically shut down after 8 seconds, as shown in the figure below.

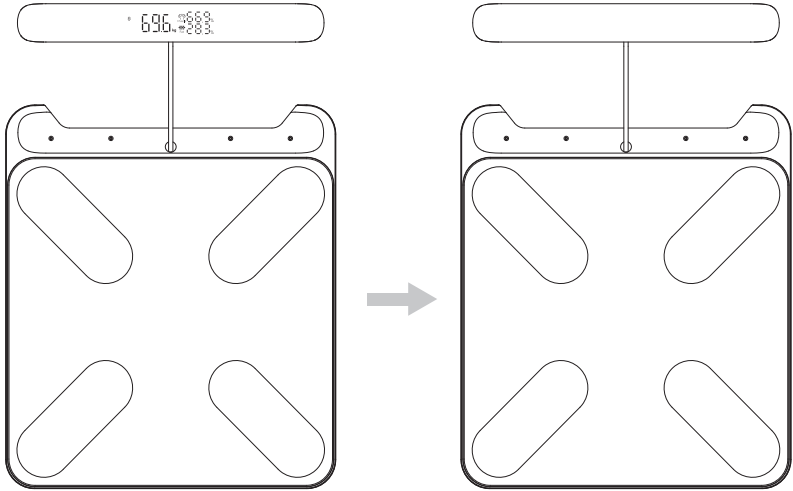

4. When the battery is low, the battery symbol and L0 are displayed, and the scale will automatically shut down after 3 seconds. Please replace the battery so that the product can be used again.



5. The maximum weighing weight of the product is 180kg. If the weight exceeds 182.0kg, the product will display the overload Err symbol and the product will automatically shut down after 3 seconds, as shown in the figure.



6. When the weighing is unstable, the product will automatically shut down after 3 seconds when the following symbol is displayed, as shown in the figure.



Basic Parameters

Product name: Smart body fat scale

Product Model: FG2202WB

Product net weight: 2.3kg

Measurement unit: kg, lb

Weighing range: 5~180kg

Scale division value: 100g

Connection mode: Bluetooth

Working temperature: 5°C~35°C

Shell material: Environmental friendly plastic + tempered glass

Power supply: 4 x 1.5V AAA batteries

Warranty Statement

For users who purchase Fiar's products through legal channels, we guarantee that each product sold is free from defects in materials and workmanship. Under normal use, we will provide warranty service for non-man-made failures caused by the product's quality problems for 12 months.

Any questions, please contact our merchant customer service.

Non-warranty scope:

- ① Human intentional or negligent damage, or unauthorized repair
- ② Damage caused by force majeure (earthquake, fire, etc.)
- ③ No warranty service for accessories and consumables
- ④ Physical damage to the surface, but does not affect the use
- ⑤ Stolen products

Troubleshooting

1. Bluetooth failed to connection.

- Make sure the scale and the Bluetooth and GPS (Android only) on your phone are on;
- Check the system version of your smart phone, it must be iOS 8.0 or higher/Android 5.0 higher;
- For successfully connection, there is a Bluetooth icon on the display and the word “Connected” will show on the circle of the homepage on phone;
- If fail to connect via Bluetooth, please click Account--->Device to find the scale ID

2.No body fat data after weighting.

- Must step onto the scale with bare feet.
- Make sure your feet and the scale are both dry.
- Step off the scale when measurement does not finish (Please keep standing on the scale around 30 second until the number on the display stops flashing).
- Bluetooth is not turned on.
- Bluetooth is paired with a difference scale.

3.Incorrect weight data occurs.

- Check whether the scale is on a hard, flat surface.
- Check each sensor foot on the back to make sure nothing is stuck to the bottom of it.

4.Incorrect fat-muscle ratio shows on App.

- The body parameter settings are incorrect, check to make sure you entered the correct gender, height, and age.
- Check if you activate the Athlete Mode.

5.How to pack up the handle after using?

- Give handle a pull UPWARDS and do it quickly but loose. Then the connecting wire will automatically contract to scale.

6.The scale does not turn on.

- Check if the insulation sheet has been pulled out.
- Check if battery has run out of power and change new batteries if needed.

Frequently Asked Questions & Answers

1. How to get the most accurate result?

- Stand on the scale firmly, do not shake when weigh-in.
- Take your measurement at the same time each day to ensure the most accurate results.
- Please place your scale on the hard/flat ground, then step on the scale with bare feet, after that the display will be turned on.
- Check your profile information (gender, age and height), make sure all the data is accurate.
- Check the place, make sure it is hard/flat, some place seems flat, but actually not, you could try to move to different hard surface until it gets the same result.
- Check the bottom of the scale before measurement, if it is not balanced, the data won't be accurate.
- Make sure that "0.0" shown on the display, before each time use.
- Keep bare feet, with each foot touching both the top and bottom electrode.

2. How to restart the scale?

- First, take one of the batteries out of the scale.
- Then, put back the batteries and wait for 5 seconds.
- After the scale has been automatic restart, you can step onto the scale.

3. How to change language?

- Fitdays APP--->Account--->Settings--->Language

4. How to change unit?

- Fitdays APP--->Account--->Settings--->Switch units

For more information, please check FQA from Fitdays APP. "Account >Settings >FAQ"

Advice

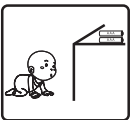

Place the scale far away from the children in case of falling down or crashing.



Do not expose the scale to heat or fire, which will easily cause explosion.



Waste electrical products should not be disposed of with household waste. Please recycle where facilities exist.

Check with your local Authority or retailer for recycling advice.



FCC Statement

This device complies with part 15 of the FCC Rules. Operation is subject to the following two conditions:

(1) this device may not cause harmful interference, and (2) this device must accept any interference received, including interference that may cause undesired operation.

Any changes or modifications not expressly approved by the party responsible for compliance could void the user's authority to operate the equipment.

NOTE: This equipment has been tested and found to comply with the limits for a Class B digital device, pursuant to Part 15 of the FCC Rules. These limits are designed to provide reasonable protection against harmful interference in a residential installation. This equipment generates, uses and can radiate radio frequency energy and, if not installed and used in accordance with the instructions, may cause harmful interference to radio communications. However, there is no guarantee that interference will not occur in a particular installation.

If this equipment does cause harmful interference to radio or television reception, which can be determined by turning the equipment off and on, the user is encouraged to try to correct the interference by one or more of the following measures:

- Reorient or relocate the receiving antenna.
- Increase the separation between the equipment and receiver.
- Connect the equipment into an outlet on a circuit different from that to which the receiver is connected.
- Consult the dealer or an experienced radio/TV technician for help.

The device has been evaluated to meet general RF exposure requirement.

The device can be used in portable exposure condition without restriction.

IC Caution

English:

This device complies with Industry Canada licence-exempt RSS standard(s).

Operation is subject to the following two conditions:

- (1) This device may not cause interference, and
- (2) This device must accept any interference, including interference that may cause

French:

Le présent appareil est conforme aux CNR d'Industrie Canada applicables aux appareils radio exempts de licence. L'exploitation est autorisée aux deux conditions suivantes:

- (1) l'appareil ne doit pas produire de brouillage, et
- (2) l'utilisateur de l'appareil doit accepter tout brouillage radioélectrique subi, même si le brouillage est susceptible d'en compromettre le fonctionnement.



FCC ID: 2A8S2-BFS2105

IC ID: 29637-BFS2105