

Important Safety Information



Read the Safety Information in this section of the manual before installing, operating or maintaining the pump.

This section must be read in conjunction with A590-00-880 and A590-00-840.



<http://www.bocedwards.com>



Contents

Section	Page
1 INTRODUCTION	1
2 INSTALLATION SAFETY	3
2.1 Locate the dry pumping system	4
2.3 Connect the dry pumping system to your vacuum/exhaust system	4
2.4 Connect the iH1800HTX exhaust TMS	5
2.6 Connect the nitrogen supply	5
2.6.1 Flammable/pyrophoric materials	5
2.6.2 Gas purges	5
2.7 Leak-test the system	6
2.8 Electrical supply	6
2.11 Connect the cooling-water hoses	7
2.14 Install additional safety equipment	7
3 OPERATION	8
3.1 Start-up	8
3.3 Manual shut-down	8
4 MAINTENANCE	9
4.1 Safety and maintenance frequency	9
4.2 Relocate the system for maintenance	11
4.5 Replace a fuse	11
5 TRANSPORTATION, STORAGE AND DISPOSAL	12
5.1 Transportation	12
5.3 Disposal	12
6 SERVICE, SPARES AND ACCESSORIES	12
6.1 Introduction	10



Please refer to the appropriate section of this safety guide when a warning symbol appears in the installation guide (A590-00-880).

1 INTRODUCTION

This manual provides information for the safe installation, operation and maintenance of the Dry Pumping Systems.

The following symbols may appear on the dry pumping system:



Warning - refer to accompanying documentation.



Warning - risk of electric shock.



Warning - hot surfaces.



Warning - moving parts present.



Warning - heavy object.



RF earth (ground).



Protective earth (ground).



Warning - use protective equipment.

The following symbols appear only in this manual:



Warning - pressurised.



Warning - Risk of explosion.

Material Safety Data Sheets for BOC Edwards supplied chemicals can be obtained by contacting BOC Edwards.

Important safety information is highlighted as WARNING and CAUTION instructions; you must obey these instructions. The use of WARNINGS and CAUTIONS is defined below.



WARNING

Warnings are given where failure to observe the instruction could result in injury or death to people.

CAUTION

Cautions are given where failure to observe the instruction could result in damage to the equipment, associated equipment and/or process.

2 INSTALLATION SAFETY



WARNING

Obey the safety instructions given below and take the appropriate precautions. If you do not, you can cause injury to people and damage to equipment.



WARNING

The system should not be operated with the BOC Edwards panels removed.



WARNING

The iH1800HTX has two separate power supplies, one for the pump system and the other for the exhaust TMS.

Potential hazards on the dry pumping system include electricity, hot surfaces, process chemicals, Fomblin oil, nitrogen and water under pressure.

Detailed safety information is given in Section 3 and BOC Edwards Publication Number P300-20-000 'Vacuum Pump and Vacuum System Safety'.

- Only BOC Edwards engineers may install the dry pumping system. Users can be trained by BOC Edwards to conduct the tasks described in this manual, contact your local service centre or BOC Edwards for more information.
- Do not remove the temporary cover or blanking plate from the dry pumping system inlet and exhaust until you are ready to connect the dry pumping system to your vacuum or exhaust-extraction system. Do not operate the dry pumping system unless the inlet and exhaust are connected to your vacuum and exhaust-extraction system.
- Vent and purge the process system (if the dry pumping system is to replace an existing pumping system) with nitrogen for 15 minutes before you start installation work. Refer to Section 4.
- Disconnect the other components in the process system from the electrical supply so that they cannot be operated accidentally.
- Electrical, nitrogen and water supplies are all potentially hazardous energy sources. Before carrying out any maintenance the supply of these sources should be locked and tagged out.
- The pump system includes provision for ventilation extraction and secondary containment of oil and water leaks. Any unintended overflows or spills must be removed immediately to avoid risk of slips.
- Obey all national and local rules and safety regulations when you install the dry pumping system. Consult BOC Edwards Publication Number P300-20-000 (Vacuum Pump and Vacuum System Safety) before you pump hazardous materials. This publication is available on request: contact your supplier or BOC Edwards.

- Route and secure cables, hoses and pipework during installation to avoid possible risk of trips.
- Be aware the the exhaust TMS can be live and maintaining a high temperature of 150°C, even if the pumping system power supply is isolated. Disconnect the pump system TMS if the pump is switched off and disconnected.

2.1 Locate the dry pumping system

	<p style="text-align: center;">WARNING</p> <p>You must use suitable lifting equipment to move the system. It is too heavy to lift by hand.</p>
---	---

	<p style="text-align: center;">WARNING</p> <p>Do not exceed the topple angle of 10 ° when moving the pump. Wheel the system on its castors to move it into its operating position. The system should only be wheeled short distances over flat surfaces. If the floor surface is uneven or has obstacles the system should be lifted with suitable lifting equipment.</p>
---	--

	<p style="text-align: center;">WARNING</p> <p>Ensure that the maximum angle between paired slings used to lift the iH system is 45°.</p>
---	---

2.3 Connect the dry pumping system to your vacuum/exhaust system

	<p style="text-align: center;">WARNING</p> <p>Pipe the exhaust to a suitable treatment plant to prevent the discharge of dangerous gases or vapours to the surrounding atmosphere.</p>
---	---

	<p style="text-align: center;">WARNING</p> <p>Do not operate the system with the exhaust pipeline blocked. If the exhaust pipeline is blocked, the system can generate exhaust pipeline pressures of up to 7 bar (7 x 10⁵ Pa).</p>
---	--

2.4 Connect the iH1800HTX exhaust TMS



WARNING

Ensure that the exhaust TMS is connected to the electrical supply through a suitably rated isolator/connector.

2.6 Connect the nitrogen supply

2.6.1 Flammable/pyrophoric materials



WARNING

You must obey the instructions and take note of any precautions given below to ensure that pumped gases do not enter their flammable ranges.

When flammable or pyrophoric materials are present within the equipment you must:

- Not allow air to enter the equipment
- Ensure that the system is leak tight
- Ensure that pumped gases do not enter their flammable range. This can be achieved by diluting flammable gases/vapours or oxidisers in the pump by supplying sufficient inert gas purge, for example dilution with nitrogen to below one quarter LEL (lower explosive limit) or, if that is not practical, to below 60% LOC (limiting oxidant concentration).
- For further information please refer to Semiconductor Pumping Application Guide (Publication no. P411-00-090) or contact BOC Edwards: refer to the address page at the rear of this manual for details of your nearest BOC Edwards company.

2.6.2 Gas purges



WARNING

If you use inert gas purges to dilute dangerous gases to a safe level, ensure that the pump is shut down if an inert gas supply fails.

Switch on the inert gas purge to remove air from the pump and the exhaust pipeline before the process starts. Switch off the purge flow at the end of the process only after the remaining flammable gases or vapours have been purged from the exhaust pipeline.

If liquids that produce flammable vapours could be present in the pump foreline, then the inert gas purge to the dry pumping system should be left on all the time this liquid is present. Flammable liquids could be present in the foreline as a result of condensation or may be carried over from the process.

When calculating the flow rate of inert gas required for dilution, consider the maximum flow rate for the flammable gases/vapours that could occur. For example, if a mass flow controller is being used to supply flammable gases to the process, you should assume a flow rate for flammable gases that could arise if the mass flow controller is fully open.

Continually measure the inert gas flow rate: if the flow rate falls below that required, then the flow of flammable gases or vapours to the pump must be stopped.

2.7 Leak-test the system



WARNING

Leak test the system after installation and seal any leaks found to prevent leakage of dangerous substances out of the system and leakage of air into the system.

2.8 Electrical supply



WARNING

This equipment is suitable for Installation Category II as defined in IEC 60664-3. Connect the system to the electrical supply through a suitably rated isolator/connector for your dry pumping system. (Refer to A590-00-840, Table 6).



WARNING

Ensure that the system and your electrical supply cable are suitably protected against earth (ground) faults and that the earth (ground) conductor of the electrical supply cable is longer than the phase conductors in the connector. You must fit a second protective earth (ground) conductor (with a cross-sectional area at least equal to phase conductor size) to the protective earth (ground) stud.



WARNING

All connections to the interface control must be double insulated or have equivalent protection. Do not connect voltages greater than 30 V a.c. or 60 V d.c. to the control/interface connections. If you do, the interface control will not provide protection against electric shock.

2.11 Connect the cooling-water hoses

	<p style="text-align: center;">WARNING</p> <p>Do not leave the cooling-water supply turned on until after you complete the electrical installation of the pump. If you do, condensation may form inside the enclosure and there may be a risk of electric shock.</p>
---	---

2.13 Commission the iH system

	<p style="text-align: center;">WARNING</p> <p>During some application cycles it is possible that the system may exceed OSHA 1910.95 Occupational Noise Exposure Limits, the EU noise directive 2003/10/EC or other regional noise limits dependant upon the process, duty cycle, installation or environment in which being operated. A sound pressure survey must be conducted after installation and, if necessary, controls implemented to ensure that the relevant limits are not exceeded during operation and that adequate precautions are taken to prevent personnel from exposure to high noise levels during operation.</p>
---	--

2.14 Install additional safety equipment

	<p style="text-align: center;">WARNING</p> <p>If your Process Tool/control system needs to know the total flow rate of nitrogen to the system for safety reasons, install suitable measurement equipment in the nitrogen supply pipeline.</p>
---	--

	<p style="text-align: center;">WARNING</p> <p>If you use the nitrogen purges to dilute dangerous gases to a safe level, ensure that the system shuts down if the nitrogen supply to the system fails.</p>
--	--

3 OPERATION

	<p style="text-align: center;">WARNING</p> <p>Do not operate the system with any enclosure panels removed or damaged and do not touch any parts of the pump(s) when the system is on. Surfaces of the pump(s) are very hot and can cause injury to people.</p>
---	---

	<p style="text-align: center;">WARNING</p> <p>Do not operate the system with any enclosures removed or damaged. If you do there may be a risk of an electric shock.</p>
---	--

3.1 Start-up

	<p style="text-align: center;">WARNING</p> <p>Ensure that it is safe to start the system. If you do not (and, for example, maintenance is being performed on components downstream of the system), you could cause injury to people.</p>
---	---

	<p style="text-align: center;">WARNING</p> <p>After the power is applied, the contactors will pull in automatically and all mains circuits will be energised.</p>
---	--

3.3 Manual shut-down

	<p style="text-align: center;">WARNING</p> <p>If you shut the system down and don't isolate it from the electrical supply, do not disconnect the Pump Display Terminal or release control from the Pump Display Terminal or front panel. If you do the system could be started by another Module.</p>
---	--

	<p style="text-align: center;">WARNING</p> <p>Do not remove the inlet connections until the pump has been allowed to stop rotating and the power has been isolated. The pump can take up to three minutes to completely stop.</p>
---	--

4 MAINTENANCE

	<p style="text-align: center;">WARNING</p> <p>Only personnel specially trained to perform electrical maintenance should attempt troubleshooting inside electrical enclosures. These enclosures contain hazardous voltages and are not operator areas.</p>
---	--

	<p style="text-align: center;">WARNING</p> <p>Leak test the system after maintenance and seal any leaks found to prevent leakage of dangerous substances out of the system and leakage of air into the system.</p>
---	---

4.1 Safety and maintenance frequency

	<p style="text-align: center;">WARNING</p> <p>Obey the safety instructions given below and take the appropriate precautions. If you do not, you can cause injury to people and damage to equipment.</p>
---	--

	<p style="text-align: center;">WARNING</p> <p>Electrical, nitrogen and water supplies are all potentially hazardous energy sources. Before carrying out any maintenance the supply of these sources should be locked and tagged out.</p>
---	---

	<p style="text-align: center;">WARNING</p> <p>The iH1800HTX has two separate power supplies, one for the pump system and the other for the exhaust TMS.</p>
---	--



WARNING

Personal protection equipment should be checked and used as specified by its supplier. Hazardous chemicals that have been pumped are located within the pumps and piping. Use of suitable protective gloves and clothing along with a respirator is recommended if contact with substances is anticipated.

Particular caution should be exercised when working with hydrocarbons which may have been exposed to temperatures greater than 260 °C. Refer to BOC Edwards Material Safety Data Sheets for detailed information.

- Ensure that the maintenance technician is familiar with the safety procedures which relate to the products pumped.
- Allow the pumps to cool to a safe temperature before you fit lifting bolts or start maintenance work.
- Vent and purge the dry pumping system with nitrogen before you start any maintenance work.
- Isolate the dry pumping system and other components in the process system from the electrical supply so that they cannot be operated accidentally. Note that the emergency stop switch on the dry pumping system is **not** an electrical isolator, unless a disconnect box accessory is installed.
- Wait for at least four minutes after you have switched off the electrical supply before you touch any electrical component on the dry pumping system.
- Route and secure cables, hoses and pipelines during maintenance to avoid possible risk of trips or entrapment.
- Ensure that any oil or water collected in the secondary containment drip tray is removed before moving the system.
- The enclosure panels should only be removed with the use of a special tool, when the system has been switched off and allowed to cool sufficiently (as an indication the system should be left for one hour with cooling water still connected at 1 l min⁻¹).
- Wear the appropriate safety-clothing when you come into contact with contaminated components. Dismantle and clean contaminated components inside a fume-cupboard.
- Re-check the pump rotation direction if the electrical supply has been disconnected.
- O-ring replacement intervals vary depending on your application.
- Dispose of components, grease and oil safely.
- Take care to protect sealing-faces from damage.
- Do not touch or inhale the thermal breakdown products of fluorinated materials which may be present if the iH system has been overheated to 260 °C and above. These breakdown products are very dangerous. Fluorinated materials in the iH system may include oils, greases and seals. The iH system may have overheated if it was misused, if it malfunctioned or if it was in a fire. BOC Edwards Material Safety Data Sheets for fluorinated materials used in the pump are available on request: contact your supplier or BOC Edwards. (refer to the address page at the rear of this manual for contact details).

4.2 Relocate the system for maintenance

	<p style="text-align: center;">WARNING</p> <p>The substances that accumulate in the exhaust-pipe, elbow and check-valve can be dangerous. Do not allow these substances to come into contact with your skin or eyes. Do not inhale vapours from these substances. Fit blanking caps to the inlet and outlet flanges when you move the exhaust-pipe, elbow or check-valve around your workplace.</p> <p>The majority of synthetic oils/grease can cause inflammation of the skin (dermatitis). Safety precautions must be taken to prevent prolonged skin contact with these substances. Use of suitable protective gloves and clothing along with a respirator is recommended if contact with the substance is anticipated.</p> <p>System process gases and residue can be highly toxic. Take all necessary precautions when handling components that have, or could have, come into contact with them, including O-rings, lubricants and all exhaust accessories.</p>
---	---

	<p style="text-align: center;">WARNING</p> <p>You must use suitable lifting equipment to move the system. It is too heavy to lift by hand.</p>
---	---

	<p style="text-align: center;">WARNING</p> <p>Do not exceed the topple angle of 10 ° when moving the pump. Wheel the system on its castors to move it into its operating position. The system should only be wheeled short distances over flat surfaces. If the floor surface is uneven or has obstacles the system should be lifted with suitable lifting equipment.</p>
--	--

4.5 Replace a fuse

	<p style="text-align: center;">WARNING</p> <p>Ensure that you replace a fuse with a new fuse of the correct rating. If you do not, the system will not be adequately protected and you can damage the system or cause injury to people. Do not remove the cover from the electrics box. High voltages exist in the electrics box when it is connected to the electrical supply. There are no spare parts that can be serviced in the electrics box.</p>
---	--

5 TRANSPORTATION, STORAGE AND DISPOSAL

5.1 Transportation



WARNING

Do not drain the oil from the pump(s) whether dangerous substances have been pumped or not. You must fit blanking plates to seal all vacuum inlet and outlet ports (to prevent possible oil leakage). You must ensure that the system is correctly labelled, if in doubt contact BOC Edwards.

5.3 Disposal



WARNING

Dispose of the system and any components safely and in accordance with all local and national safety and environmental requirements.

6 SERVICE, SPARES AND ACCESSORIES

6.1 Introduction



WARNING

Whenever you return the dry pumping system to a BOC Edwards Service Centre or other BOC Edwards company, you must comply with the requirements of Section 6 and with the requirements of the Return of BOC Edwards Equipment Procedure (refer to forms HS1 and HS2 at the rear of this manual).

Return of BOC Edwards Equipment – Procedure

INTRODUCTION

Before returning your equipment, you must warn BOC Edwards if substances you used (and produced) in the equipment can be hazardous. This information is fundamental to the safety of our Service Centre employees and will determine the procedures employed to service your equipment.

Complete the Declaration (HS2) and send it to BOC Edwards before you dispatch the equipment. It is important to note that this declaration is for BOC Edwards internal use only, and has no relationship to local, national or international transportation safety or environmental requirements. As the person offering the equipment for shipment, it is your responsibility to ensure compliance with applicable laws.

GUIDELINES

- Equipment is '**uncontaminated**' if it has not been used, or if it has only been used with substances that are not hazardous. Your equipment is '**contaminated**' if it has been used with any substances classified as hazardous under EU Directive 67/548/EEC (as amended) or OSHA Occupational Safety (29 CFR 1910).
- If your equipment has been used with radioactive substances, biological or infectious agents, mercury, polychlorinated biphenyls (PCB's), dioxins or sodium azide, you must decontaminate it before you return it to BOC Edwards. You must send independent proof of decontamination (for example a certificate of analysis) to BOC Edwards with the Declaration (HS2). Phone BOC Edwards for advice.
- If your equipment is contaminated, you must either:
 - Remove all traces of contamination (to the satisfaction of laws governing the transportation of dangerous/hazardous substances).
 - Or, properly classify the hazard, mark, manifest and ship the equipment in accordance with applicable laws governing the shipment of hazardous materials.

Note: Some contaminated equipment may not be suitable for airfreight.

PROCEDURE

1. Contact BOC Edwards and obtain a Return Authorisation Number for your equipment.
2. Complete the Return of BOC Edwards Equipment - Declaration (HS2).
3. If the equipment is contaminated, you must contact your transporter to ensure that you properly classify the hazard, mark, manifest and ship the equipment, in accordance with applicable laws governing the shipment of contaminated/hazardous materials. As the person offering the equipment for shipment, it is your responsibility to ensure compliance with applicable law. **Note: Equipment contaminated with some hazardous materials, such as semiconductor by-products, may not be suitable for airfreight - contact your transporter for advice.**
4. Remove all traces of hazardous gases: pass an inert gas through the equipment and any accessories that will be returned to BOC Edwards. Where possible, drain all fluids and lubricants from the equipment and its accessories.
5. Seal up all of the equipment's inlets and outlets (including those where accessories were attached) with blanking flanges or, for uncontaminated product, with heavy gauge tape.
6. Seal equipment in a thick polythene/polyethylene bag or sheet.
7. If the equipment is large, strap the equipment and its accessories to a wooden pallet. If the equipment is too small to be strapped to a pallet, pack it in a suitable strong box.
8. Fax or post a copy of the Declaration (HS2) to BOC Edwards. The Declaration must arrive before the equipment.
9. Give a copy of the Declaration (HS2) to the transporter. You must tell your transporter if the equipment is contaminated.
10. Seal the original Declaration in a suitable envelope: attach the envelope securely to the outside of the equipment package, in a clear weatherproof bag.

**WRITE YOUR RETURN AUTHORISATION NUMBER CLEARLY ON THE OUTSIDE OF THE ENVELOPE
OR ON THE OUTSIDE OF THE EQUIPMENT PACKAGE.**

Installation, Operation and Maintenance Guide

iH Dry Pumping Systems

Description

iH80
iH160
iH160HTX
iH600
iH1000
iH1800
iH1800HTX
iH1800NRV
iH1800NRV HTX

Item Number

A590-00-xxx
A590-10-xxx
A590-12-xxx
A590-20-xxx
A590-30-xxx
A590-40-xxx
A590-42-xxx
A590-50-xxx
A590-52-xxx

Where xxx is as follows:

460V, 60Hz, 3 phase
200 / 208V, 50/60Hz, 3 phase
380 / 415V, 50Hz, 3 phase
230V, 60Hz, 3 phase

908
945
946
957



Read the Safety Guide before installing, operating or maintaining this pump.



 **BOC EDWARDS**

<http://www.bocedwards.com>



Declaration of Conformity

We, BOC Edwards,
Manor Royal,
Crawley,
West Sussex RH10 2LW, UK

declare under our sole responsibility that the product(s):

iH Dry Pumping System with the following components:

	Standard	HTX	Where xxx is as follows:
iH80	A590-00-xxx		908 – 460V, 60Hz, 3-phase
iH600	A590-20-xxx		945 – 200/208V, 50/60Hz, 3-phase
iH1000	A590-30-xxx		946 – 380/415V, 50Hz, 3-phase
iH160	A590-10-xxx	A590-12-xxx	957 – 230V, 60Hz, 3-phase
iH1800	A590-40-xxx	A590-42-xxx	
iH1800 NRV	A590-50-xxx	A590-52-xxx	

iH interface Module fitting kit	A505-35-000
iH enclosure extraction fan (for iH80 and iH600 only)	A505-39-000
iH Light Duty exhaust check valve	A505-56-000

to which this declaration relates is in conformity with the following standard(s) or other normative document(s):

EN1012-2 (1997)	Compressor and Vacuum Pumps Safety Requirements; Part 2 - Vacuum Pumps.
EN61010-1 (2001)	Safety Requirements for Electrical Equipment for Measurement, Control and Laboratory Use; Part 1 – General Requirements.
EN61326 (1998 + A2:2001)	Electrical Equipment for Measurement, Control and Laboratory Use – EMC Requirements
(Industrial locations immunity – Class A equipment emissions)	
UL3101-1 (1st edition 1993)	Electrical Equipment for Laboratory Use; Part 1 – General Requirements
SEMI S2-93A	Environmental Health and Safety Guideline for Semiconductor Manufacturing Equipment.

when installed in accordance with the instruction manual supplied with the pump,

following the provisions of:

73/023/EEC	Low Voltage Directive.
89/336/EEC	Electromagnetic Compatibility Directive.
98/37/EC	Machinery Safety Directive.



Dr J. D. Watson, Director of Technology, Vacuum Equipment and Exhaust Management Product Divisions

11 JULY 2005 SHORSHAM

Date and Place

This product has been manufactured under a quality system registered to ISO9001

Declaration of Conformity

We, BOC Edwards,
Manor Royal,
Crawley,
West Sussex RH10 2LW, UK

declare under our sole responsibility that the product(s):

iH Dry Pumping System with the following components:

	Standard	F	HTF	Where xxx is as follows:
iH80	A590-00-xxx	A590-01-xxx		908 – 460V, 60Hz, 3-phase
iH600	A590-20-xxx	A590-21-xxx		945 – 200/208V, 50/60Hz, 3-phase
iH1000	A590-30-xxx	A590-31-xxx		946 – 380/415V, 50Hz, 3-phase
iH160	A590-10-xxx	A590-11-xxx	A590-13-xxx	957 – 230V, 60Hz, 3-phase
iH1800	A590-40-xxx	A590-41-xxx	A590-43-xxx	
iH1800 NRV	A590-50-xxx	A590-51-xxx	A590-53-xxx	
iH interface Module fitting kit			A505-35-000	
iH enclosure extraction fan (for iH80 and iH600 only)			A505-39-000	
iH Light Duty exhaust check valve			A505-56-000	

to which this declaration relates is in conformity with the following standard(s) or other normative document(s):

EN1012-2 (1997)	Compressor and Vacuum Pumps Safety Requirements; Part 2 - Vacuum Pumps.
EN61010-1 (2001)	Safety Requirements for Electrical Equipment for Measurement, Control and Laboratory Use; Part 1 – General Requirements.
EN61326 (1998 + A2:2001)	Electrical Equipment for Measurement, Control and Laboratory Use – EMC Requirements
(Industrial locations immunity – Class A equipment emissions)	
UL3101-1 (1st edition 1993)	Electrical Equipment for Laboratory Use; Part 1 – General Requirements
SEMI S2-93A	Environmental Health and Safety Guideline for Semiconductor Manufacturing Equipment.

when installed in accordance with the instruction manual supplied with the pump,

following the provisions of:

73/023/EEC	Low Voltage Directive.
89/336/EEC	Electromagnetic Compatibility Directive.
98/37/EC	Machinery Safety Directive.

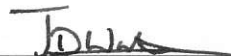
Dr J. D. Watson, Director of Technology, Vacuum Equipment and Exhaust Management Product Divisions

11 July 2005 Stoneham

Date and Place

This product has been manufactured under a quality system registered to ISO9001

iH F and iH HTF Dry Pumping Systems

This document describes additions to the above documents for the iH F and iH HTF dry pumping systems. Please read this document in conjunction with the above documents.

All references to HTX in the above documents also apply to HTF.

Front cover

Description	Item Number	Where xxx is as follows:	
iH80F	A590-01-xxx	460V, 60Hz, 3 phase	908
iH160F	A590-11-xxx	200 / 208V, 50/60Hz, 3 phase	945
iH160HTF	A590-13-xxx	380 / 415V, 50Hz, 3 phase	946
iH600F	A590-21-xxx	230V, 60Hz, 3 phase	957
iH1000F	A590-31-xxx		
iH1800F	A590-41-xxx		
iH1800HTF	A590-43-xxx		
iH1800NRV F	A590-51-xxx		
iH1800NRV HTF	A590-53-xxx		



Warning

The iHF Breach Sensor is not a safety device. Failure to use normal control measures in the event of a leak could result in injury to people and damage to equipment.

The iHF systems for hazardous gas pumping use compatible elastomers and an innovative Breach Sensor that reduces the risk of hazardous gas leaks during run til crash.



Please refer to the appropriate Section in A590-00-860 for important safety information when you see a warning symbol.

Contents

Section	Page
1 INTRODUCTION	1
1.1 Applications	1
1.2 The iH HTX system	1
1.3 iH NRV systems	2
1.4 Priority of control	2
2 INSTALLATION	5
2.1 Locate the dry pumping system	5
2.2 Lubrication	6
2.3 Connect the dry pumping system to your vacuum / exhaust system	6
2.4 Connect the iH1800HTX exhaust TMS	7
2.5 Connect to your factory extraction system (optional)	7
2.6 Connect the nitrogen supply	7
2.7 Leak-test the system	8
2.8 Electrical supply	8
2.8.1 Reconfigure the iH system for your electrical supply	8
2.8.2 Reconfigure the iH system for your electrical supply (iH80/600 only)	8
2.8.3 Connect the electrical supply	11
2.9 Connect an additional RF earth (ground) (optional)	13
2.10 Connect to your emergency stop circuit	13
2.11 Connect the cooling-water hoses	13
2.12 Accessories	14
2.13 Commission the iH system	14
2.14 Install additional safety equipment	15
3 OPERATION	16
3.1 Start-up	16
3.2 Status indicators	16
3.3 Manual shut-down	17
3.4 Automatic shut-down	17
3.5 Unplanned shutdown and alarms	18
3.6 Emergency stop	18
3.7 Restart the pump after an emergency stop or automatic shut-down	19
3.8 Single equipment monitor (SEM)	19

dja0291

Contents (continued...)

Section	Page
4 MAINTENANCE	20
4.1 Safety and maintenance frequency	20
4.2 Relocate the system for maintenance	20
4.3 Cleaning the pump	21
4.4 General maintenance	21
4.5 Replace a fuse	21
4.6 Inspect the connections, pipelines, cables and fittings	21
5 TRANSPORTATION, STORAGE AND DISPOSAL	22
5.1 Transportation	22
5.2 Storage	22
5.3 Disposal	22
6 SERVICE, SPARES AND ACCESSORIES	23
6.1 Introduction	23
6.2 Service	23
6.3 Ordering accessories	24

Illustrations

Figure	Page
1 iH applications chart	1
2 Priority of control	2
3 The controls/connectors	3
4 The front panel controls	4
5 System arrangement to reduce effective footprint (if required)	5
6 Reconfigure the iH system for your electrical supply	9
7 Reconfigure the pump-motor terminal-boxes (iH80/600 only)	10
8 Connect electrical supply cable to the connector mating-half	12

Tables

Table	Page
1 Safety sensors	18
2 Accessories	20





Please refer to the appropriate Section in A590-00-860 for important safety information when you see a warning symbol.

iH Dry Pumping System

1 INTRODUCTION

1.1 Applications

If you use the iH system on an application for which it is not suitable (refer to Figure 1), you may invalidate your warranties. If in doubt, contact BOC Edwards who will advise you as to the suitability of the iH system for any particular application.

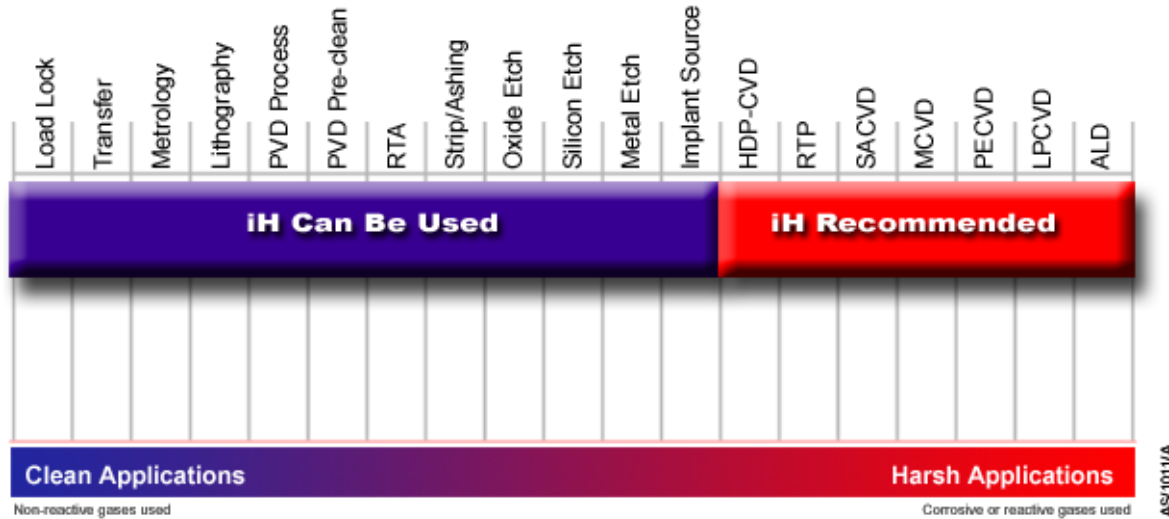

Figure 1 - iH applications chart

Note: This product is not ATEX compliant, a range of ATEX compliant pumping systems are available, contact BOC Edwards for details.

1.2 The iH HTX system

For enhanced performance on harsh duty processes, especially those prone to condensation of process gases inside the pumping system. This is achieved by:

- Increased dry pump operating temperature
- Increased gas purge capacity
- Increased exhaust diameter and exhaust TMS (thermal management system)
- Provision for optional heated exhaust purge



Please refer to the appropriate Section in A590-00-860 for important safety information when you see a warning symbol.

iH Dry Pumping System

1.3 The iH NRV systems

For Flat Panel Display processes

1.4 Priority of control

The system can be controlled by a number of modules: the Pump Display Terminal (PDT), from the tool through the IM interface and communications module, iTIM, or from the Single Equipment Monitor (refer to Figure 3). Only one of these can have control of the iH system at any one time. That is, once one of these has control of the iH system, control requests from the others are denied.

The PDT indicates who is in control. LEDs are also provided on the rear panel, front panel or PDT, which illuminate to indicate 'in control'. Please refer to Figure 2.

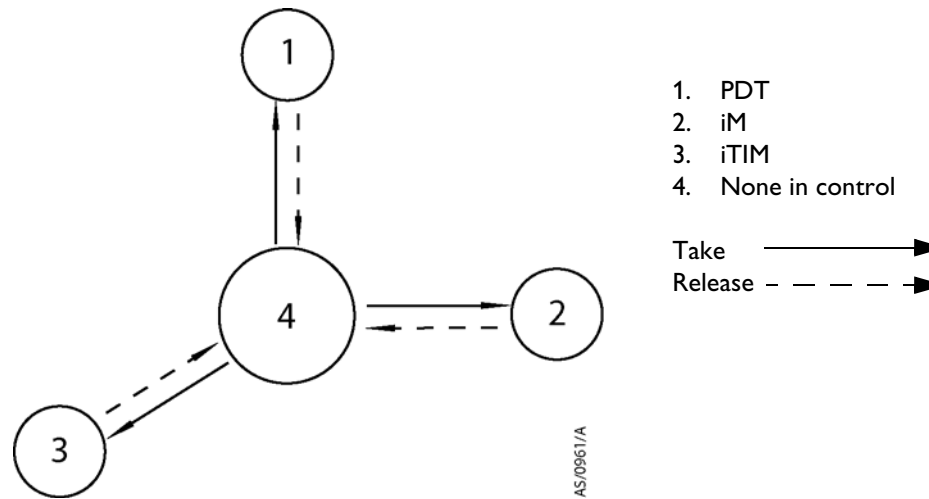

Figure 2 - Priority of control



Please refer to the appropriate Section in A590-00-860 for important safety information when you see a warning symbol.

iH Dry Pumping System



Figure 3 - The controls/connectors on rear of pump

Item	Control/connector identification
1	Electrical box
2	Exhaust check valve
3	Cooling-water supply connection
4	Seismic bracket (4 off)
5	RF earth (ground) stud M6
6	Cooling-water return connection
7	Levelling feet (4 off)
8	Nitrogen purge port
9	Castor (4 off)
10	Exhaust enclosure
11	Active gauge connection
12	iTIM connection
13	Rear cover

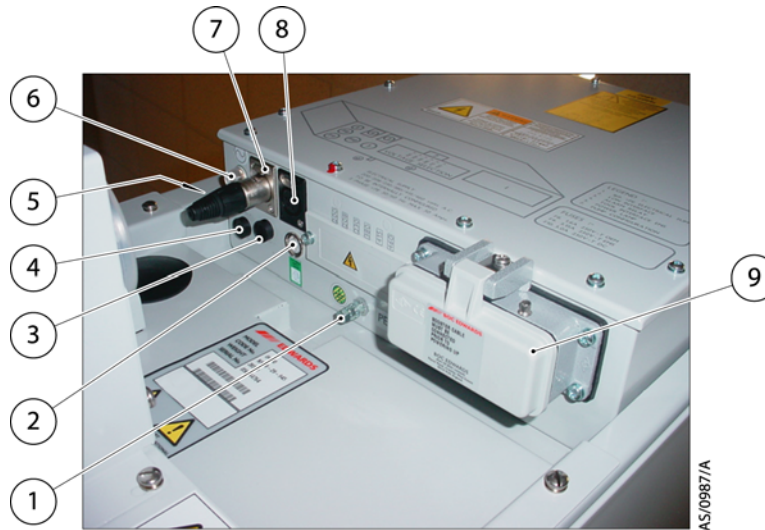

Figure 4 - The controls/connectors on electrics box

Item	Control/connector identification
1	Protective earth (ground) stud M5
2	Exhaust gas outlet connection
3	d.c. Electrical supply fuse holder (F10)
4	Emergency stop fuse holder (F9)
5	Tool interface module fuse holder (F8)
6	Rear Power on lamp
7	EMS/Tool interface module connection
8	LON module connection
9	Electrical supply connection



Please refer to the appropriate Section in A590-00-860 for important safety information when you see a warning symbol.

iH Dry Pumping System

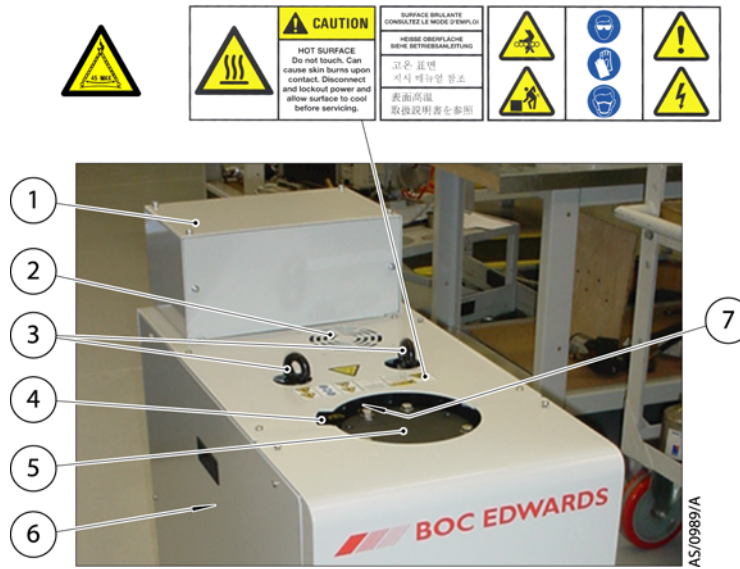

Figure 5 - Top view of pump

Item	Description
1	Inverter*
2	Extraction port
3	Lifting eyebolts (2 off)
4	RF earth (ground) cable
5	Pumped gas inlet connection
6	Leak-test port (combination)
7	Leak-test port (pump only)

* iH160/1000/1800 only

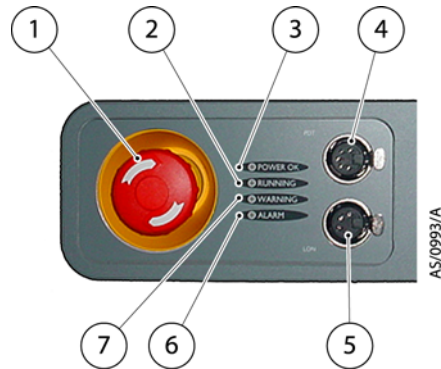

Figure 6 - The front panel controls

Item	Control/connector identification
1	EMS button
2	Running LED (green)
3	Power OK LED (green)
4	Pump display terminal connection
5	LON module connection
6	Alarm LED (red)
7	Warning LED (amber)



Please refer to the appropriate Section in A590-00-860 for important safety information when you see a warning symbol.



2 INSTALLATION



2.1 Locate the dry pumping system



Use the following procedure to locate the iH system in its operating position. The iH system must be located on a firm, level surface, to ensure that the system is not damaged.

1. Use suitable lifting equipment attached to the lifting eyebolts (Figure 5, item 8) to move the iH system close to its final operating position.
2. Adjust the levelling feet (Figure 3, item 7) to make sure that the iH system is level and is not supported by the castors.
3. If required, the iH system can be secured to the floor by fitting suitable bolts or studs (not supplied) through the M10 docking points on the chassis. If vibration transmission to the floor is a concern, suitable vibration isolators (not supplied) should be fitted between the docking points and the bolt or stud, if doing this the levelling feet will need to be removed.
4. If preferred, the lifting eyebolts can be removed and replaced with the lifting eyebolt hole plugs supplied with the systems.
5. Ensure that access is possible to the emergency stop button (refer to Figure 6, item 1), if not use an iH Disconnect Box (refer to Section 6.3).

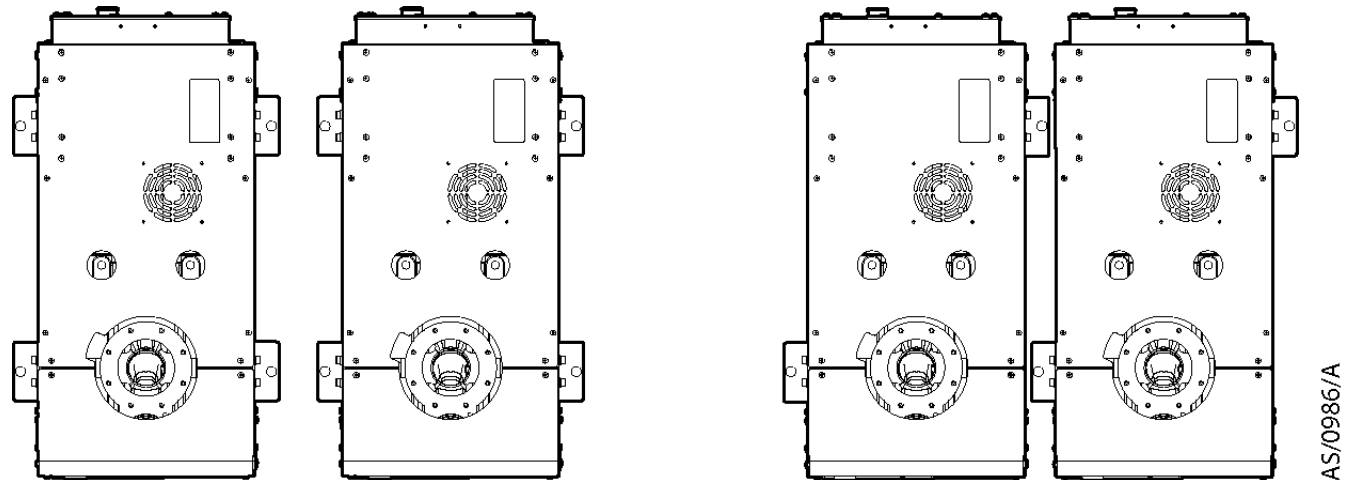

AS/0986/A

Figure 7 - System arrangement to reduce effective footprint (if required)



iH Dry Pumping System

If you want to secure the iH in place to prevent inadvertent movement (for example, during an earthquake), take note of the following:

- The iH system seismic brackets (Figure 3, item 4) are designed to withstand a level 4 earthquake in a ground floor installation.
- The iH system can be secured to the floor by fitting suitable bolts or studs (not supplied) through the 17.5 mm hole in the seismic brackets.
- If vibration transmission to the floor is a concern, suitable vibration isolators (not supplied) should be fitted between the seismic brackets and the bolt or stud.
- Although the iH system is supplied with four seismic brackets, two brackets are capable of protecting the system during an earthquake. The system can therefore be secured as shown in Figure 7 for example, to reduce the effective system footprint if required.
- If all four seismic brackets are to be used, ensure that the bolt spacing is adequate for the floor strength and loads anticipated.

2.2 Lubrication

CAUTION

Ensure that the oil-levels in the HCDP pump and the HMB pump are correct. If a pump oil-level is incorrect, pump performance may be affected and the pump may be damaged.

The iH system is given a charge of oil before it leaves the factory. There is no requirement to adjust the oil level.



2.3 Connect the dry pumping system to your vacuum/exhaust system

CAUTION

Use a catchpot to prevent the drainage of condensate back into the iH system. Condensate that drains back into the iH could damage the HCDP pump.

Do not reuse any O-ring or O-ring assembly and do not allow debris to get into the iH system during installation.

When you connect your iH system to your vacuum system, take note of the following:

- To get the best pumping speed, ensure that the pipeline which connects the vacuum system to the iH system is the minimum length possible and has an internal diameter not less than the iH system inlet-port.
- Ensure that all components in the vacuum pipeline have a maximum pressure rating which is greater than the highest pressure that can be generated in your system.
- Incorporate flexible pipelines in the vacuum pipeline to reduce the transmission of vibration and to prevent loading of coupling-joints. We recommend that you use BOC Edwards braided flexible pipelines. The pipelines should be suitable for 110 °C.
- Adequately support vacuum/exhaust pipelines to prevent the transmission of stress to pipeline coupling-joints.



Please refer to the appropriate Section in A590-00-860 for important safety information when you see a warning symbol.

iH Dry Pumping System

- Incorporate a pressure gauge in the inlet pipeline, so that you determine that the iH system operates correctly.
 - You must be able to isolate the iH system inlet from the atmosphere and from your vacuum system if you have pumped or produced corrosive chemicals.
 - The outlet of the exhaust pipe can have a check-valve fitted which prevents the suck-back of exhaust vapours after the iH system is shutdown. The check-valve also provides additional attenuation of the pulses in exhaust pressure.
 - On very dusty applications, use a low-impedance inlet-filter to minimise damage to the pump.
 - The exhaust pipelines should be suitable for 150°C for HTX systems.
1. Remove the temporary cover or blanking plate from the inlet of the iH system. Retain the nuts, bolts, washers and blanking plate for future use. Retain the temporary cover for future use on non-contaminated pumps only.
 2. Use the O-ring supplied and suitable nuts, bolts and washers (not supplied) to connect the inlet-flange (Figure 5, item 3) of the iH system to your vacuum system.
 3. Use the NW40 trapped O-ring and clamp supplied to connect the exhaust outlet (Figure 3, item 2) on the exhaust pipe, to your exhaust extraction system. If check valve/elbow are not required for your application refer to the web.

2.4 Connect the iH1800HTX exhaust TMS



Refer to BOC Edwards instruction manual Y140-00-880 'TMS Temperature Management System' for details. A separate power supply can be ordered if required, refer to Section 6.3 for details.

2.5 Connect to your factory extraction system (optional)

Refer to Figure 5, item 2.



2.6 Connect the nitrogen supply

CAUTION

Ensure that your nitrogen supply conforms to the requirements given in the Technical Data Section. If it doesn't, the flow sensors may not operate correctly, the gas pipelines may become blocked or the iH system may be damaged.

Refer to Figure 3, item 5.

Note: For optimum nitrogen, ensure that your nitrogen supply complies with the Technical Data Section. Refer to Table 2.



Please refer to the appropriate Section in A590-00-860 for important safety information when you see a warning symbol.

iH Dry Pumping System



2.7 Leak-test the system

Note: If you need further information on leak-testing, look it up on the Web using URL at the start of manual, or contact your supplier or BOC Edwards for advice.

Refer to Figure 5, items 6 or 7.

2.8 Electrical supply

2.8.1 Reconfigure the iH system for your electrical supply (if necessary)

CAUTION

iH160/1000/1800 systems are supplied already configured for your electrical supply. The iH system cannot be reconfigured between the low voltage (200V to 230V) and high voltage (380V to 460V) ranges.

Contact your supplier or BOC Edwards if you wish to use the iH system with a power supply in a different voltage range to that specified on the rating plate. To reconfigure the iH system within its standard voltage range, refer to Figure 8 and ensure that the correct transformer primary tapping is selected using the following procedure:

1. Ensure power supplies to the iH system are disconnected.
2. Undo the screws (2) which secure the cover (1) to the Electrics Box (3) and remove the cover.
3. Ensure that the common cable (4) is correctly connected to the common terminal on the terminal-block (6).
4. Ensure that the voltages select cable (5) is connected to the correct voltage terminal of the terminal-block (6) for your electrical supply.
5. Refit the cover (1) and secure with the two screws (2).

2.8.2 Reconfigure the iH system for your electrical supply (iH80/600 only)

If you want to use an iH80 or iH600 system with a different electrical supply, use the following procedure:

1. Refer to Figure 9. Undo and remove the six screws which secure the rear cover over the HCDP pump-motor, and remove the rear cover.
2. Undo and remove the four screws which secure the cover to the pump-motor terminal-box.
3. Look at the links in the terminal-box (1):
 - For high voltage operations (380-415 V at 50Hz or 460 V at 60Hz), ensure that the links (2) are in the positions shown in Figure 9.
 - For low voltage operations (200-208 V at 50Hz or 200-230 V at 60Hz), ensure that the links (2) are in the positions shown in Figure 9.
4. Refit the cover to the pump-motor terminal-box and secure with four screws.
5. Refit the rear cover and secure with the six screws.
6. If you have iH600, continue at step 7, otherwise continue at Section 2.8.3.
7. Undo and remove the four screws, which secure the electrics box to the rear of the iH system, then carefully lower and support the module. Ensure that you do not disconnect, break or damage any of the cables connected to the module.



Please refer to the appropriate Section in A590-00-860 for important safety information when you see a warning symbol.

iH Dry Pumping System

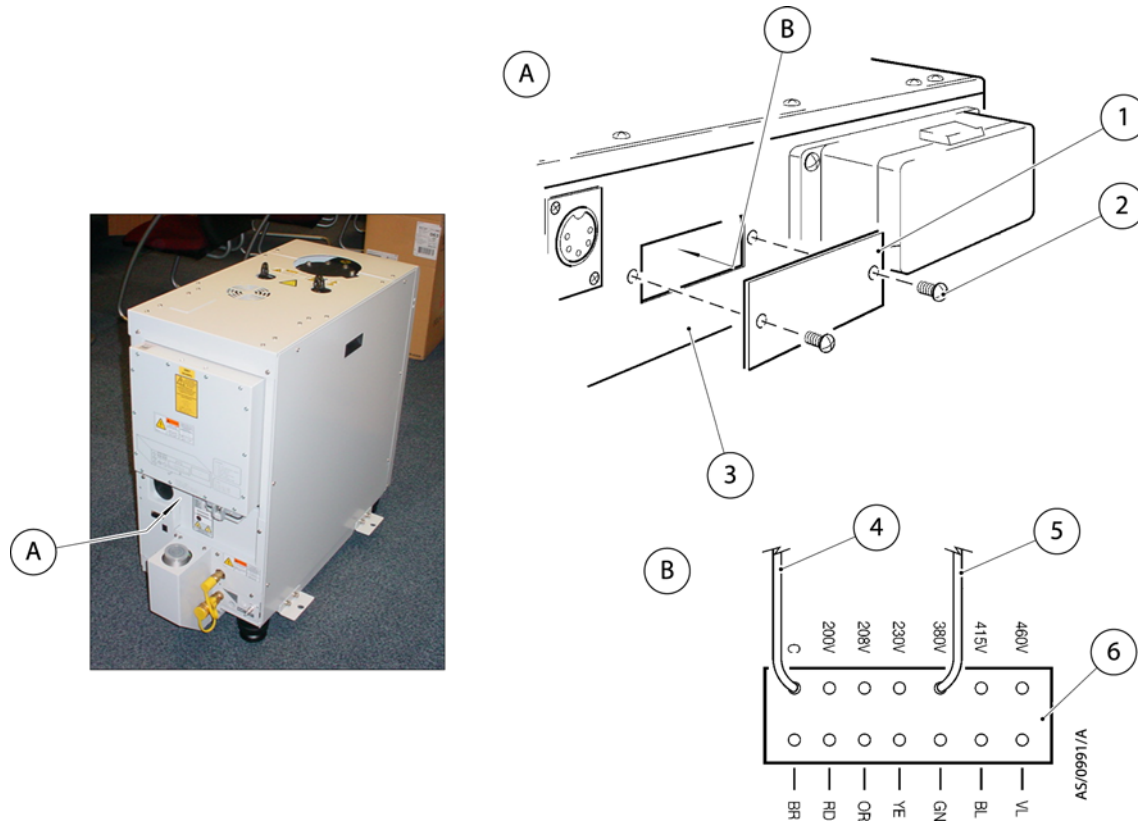

Item	Control/connector identification
1	Cover
2	Screw (2 off)
3	Electrics box
4	Common cable
5	Voltage select cable
6	Terminal block

Figure 8 - Reconfigure the iH system for your electrical supply



Please refer to the appropriate Section in A590-00-860 for important safety information when you see a warning symbol.

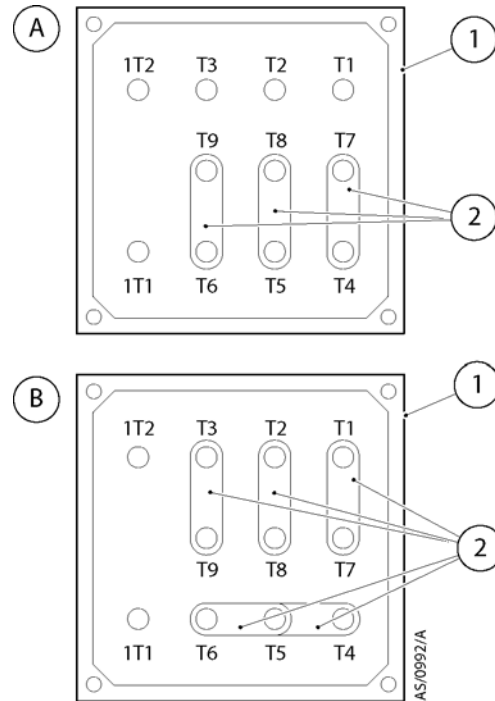

Item	Description
1	Pump-motor terminal-box
2	Links

Figure 9 - Reconfigure the pump-motor terminal-boxes (iH80/iH600 only)



Please refer to the appropriate Section in A590-00-860 for important safety information when you see a warning symbol.

iH Dry Pumping System

8. Carry out steps 2, 3 and 4.
9. Refit the electrics box to the rear of the iH system and secure with the four screws: ensure that you do not trap any of the cables connected to the electrics box.



2.8.3 Connect the electrical supply

CAUTION

This is an industrial (Class A) product as defined by EN61326. To ensure compliance with European Electromagnetic Compatibility (EMC) requirements for EMC emissions, please note that it is not intended for use in domestic buildings, or in properties directly connected to an electrical supply network which also supplies domestic buildings.

CAUTION

Do not connect voltages greater than specified in Table 5 to the control/interface connections. If you do, the interface control may be damaged.

Note: BOC Edwards recommend that the electrical supply be connected to a suitable isolator, which is easily accessible for maintenance and clearly identified.

Note: If you need further information on connecting the electrical supply, look it up on the Web using URL at the start of manual, or contact your supplier or BOC Edwards for advice.

Note: On an iH160,1000 or 1800 system, the earth (ground) installation must ensure that there is an equipotential zone around the iH system: the voltage between the protective earth (ground) stud on the iH system and any other conducting surface within 2 metres of the iH system must be <30 V r.m.s.

Note: If you connect the electrical supply to an iH160,1000 or 1800 system through ELCB relays, they must be suitable for protection of equipment with a d.c. component in the fault current, and suitable for short duration switch-on surges, and for high leakage current (for example, type B, according to prEN50178). The iH160,1000 or 1800 system is for use only with equipment that has no accessible terminals.

Refer to Figure 4, item 10.

Use the following procedure to connect the electrical supply to the iH system. When you make your electrical supply cable, ensure that the earth (ground) conductor is longer than the phase conductors. This will ensure that if the cable is accidentally dragged and the strain relief bush on the electrical supply connector mating-half fails, the earth (ground) conductor will be the last conductor to be pulled from the connector.

1. Refer to Figure 10. Remove the connector block from the cover (10) of the mating-half supplied for the electrical supply connector, then pass a suitable cable (9) through the strain relief bush (8) on the cover (10). Refer to Section 2 for suitable cable sizes.
2. Connect the cable phase wires to the pins in the connector block as shown in Table 5.



Please refer to the appropriate Section in A590-00-860 for important safety information when you see a warning symbol.

iH Dry Pumping System

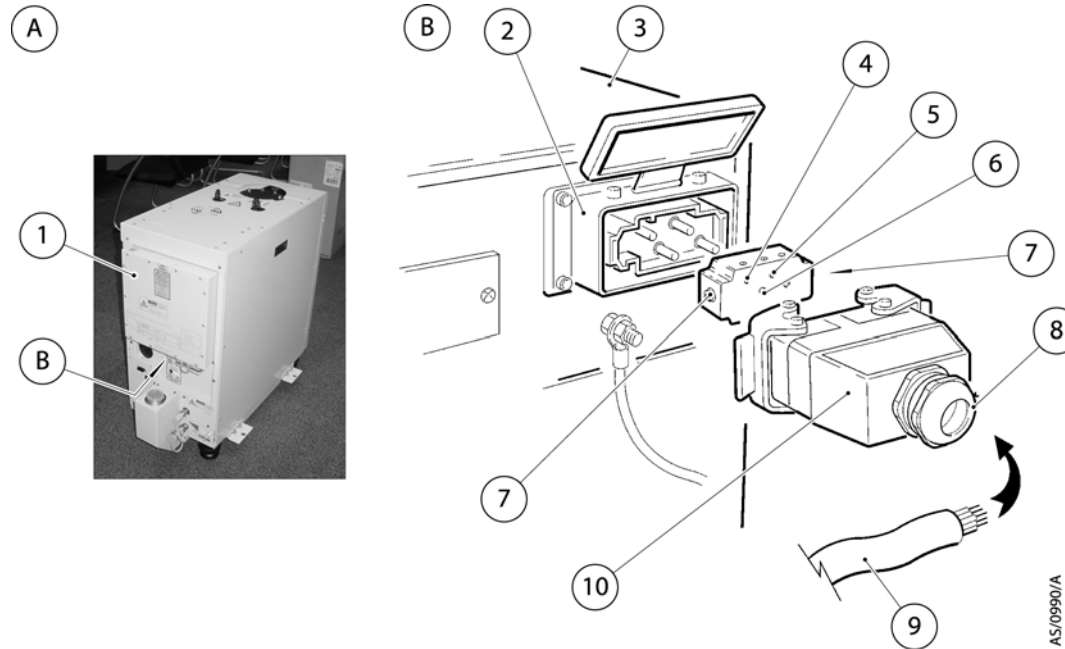

Item	Control/connector identification
1	Electrics box
2	Electrical supply connector
3	Electrics box
4	Pin 1 (phase 1)
5	Pin 2 (phase 2)
6	Pin 3 (phase 3)
7	Earth (ground) screw
8	Strain Relief bush
9	Electrical supply cable
10	Cover

Figure 10 - Connect the electrical supply cable to the connector mating-half



Please refer to the appropriate Section in A590-00-860 for important safety information when you see a warning symbol.

iH Dry Pumping System

3. Connect the earth (ground) wire of the cable to one of the two earth (ground) screws (7) on the side of the connector block.
4. Refit the cover (10) to the connector block then tighten the strain relief bush (8).
5. Fit the mating-half to the electrical supply connector (2) on the Electrics Box (1).
6. Connect the other end of the electrical supply cable to your electrical supply through a suitable isolator, or via the disconnect box (refer to Section 6.3).
7. On iH80, 160 and 600 systems, we recommend that you fit a second protective earth (ground) conductor to the protective earth (ground) stud on the Electrics Box (Figure 3, item 1) and connect the other end of this conductor to your factory earth (ground). On an iH1000 and 1800 systems, you must fit a second protective earth (ground) conductor.

2.9 Connect an additional RF earth (ground) (optional)

If you will operate the iH system in an area subject to high RF (radio frequency) emissions, in accordance with good RF installation practice, we recommend that you:

- Use a star washer to connect the end of the earth (ground) cable (Figure 5, item 4) connected to the iH inlet to one of the bolts that you use to secure the inlet-flange.
- Connect an additional earth (ground) cable to the RF earth (ground) stud (Figure 3, item 8). You must use a suitable low-impedance cable (for example, use braided cable).

2.10 Connect to your emergency stop circuit

Note: If you do not connect to your own control equipment, you must fit the Tool Interface Module plug supplied (Figure 3, item 7) on the rear of the iH system. If you do not, you will not be able to operate the iH system.

If required, you can connect your own control equipment to the iH system to shut it down in an emergency using the EMS connection (Figure 3, item 7 and Table 5). The emergency stop control must be compliant with IEC 60947-5-1 (This should be a red self latching mushroom push button on a yellow background.)

2.11 Connect the cooling-water hoses

Note: For optimum water-cooling, ensure that your cooling-water supply complies with the Technical Data Section (A590-00-840) and that they are connected in parallel. Refer to Figure 3, items 3 and 6. BOC Edwards would recommend that quick connectors be used to reduce the risk of water spillage during connection/disconnection.



Note: For minimum water consumption, regulate the cooling-water flow to the iH system.

Connect the cooling-water supply as follows:



Please refer to the appropriate Section in A590-00-860 for important safety information when you see a warning symbol.

iH Dry Pumping System

1. Use 3/8 inch BSP male pipe fittings (which you must supply) to fit the female quick-release connector to the cooling-water supply hose and to fit the male quick-release connector to the cooling-water return hose.
2. Remove the dust-caps from the cooling-water inlet and outlet.
3. Connect your water return hose to the cooling-water outlet (Figure 3, item 16) and connect your water supply hose to the cooling-water inlet (Figure 3, item 3).
4. Turn on the cooling-water supply.
5. Inspect the water hoses, pipelines and connections and check that there are no leaks.

Turn off the water supply while you complete the remainder of the installation procedures.

2.12 Accessories

Refer to the individual accessories manuals for installation, information, refer to Section 6.3.

The disconnect box when fitted, is used to energize and isolate the power supply to the system. It also allows the isolation of the electrical supply during an emergency, and for maintenance and trouble shooting the system, thereby satisfying SEMI S2 requirements. The photohelic switch/gauge when fitted, allows monitoring for loss of extraction from the enclosure, thereby satisfying SEMI S2 requirements

2.13 Commission the iH system



1. Switch on the external electrical supply and check that the power OK LED (Figure 6, item 3) goes on. If the LED does not go on, contact BOC Edwards or refer to the Web.
2. Switch on the cooling-water and nitrogen supplies.
3. Ensure that the exhaust-extraction system is not blocked (for example, that valves in the exhaust-extraction system are open).
4. Ensure that all openings to atmospheric pressure in the foreline vacuum system are closed.
5. Connect the PDT to the front of the iH system (Figure 6, item 4)
6. Press CONTROL button, press ENTER button, LOCAL CONTROL green LED illuminates, press START, press ENTER.
7. If the iH system starts and continues to operate, continue at Step 7. If a warning or alarm condition is indicated:
 - Shut-down the iH system: refer to Section 3.3.
 - Contact BOC Edwards or refer to the Web.
8. Look at the pressure gauge in your inlet pipeline:
 - If the pressure is increasing, the HCDP pump-motor terminal-box (and/or if you have an iH160, 1000 or 1800 system, the HMB pump-motor terminal-box) is incorrectly wired: immediately shut down the iH system, correct the electrical wiring, then repeat this procedure from step three again.
 - If the pressure is decreasing continue at step 8.
9. After you have commissioned the iH system:
 - If you want to continue to operate the iH system, refer to Section 3.1, step 4.
 - Otherwise, shut-down the system: refer to Section 3.3.



Please refer to the appropriate Section in A590-00-860 for important safety information when you see a warning symbol.

iH Dry Pumping System



2.14 Install additional safety equipment



If the sensors or microprocessors fail, the total flow rate of nitrogen displayed or output by the iH system may be incorrect. If you need to know the total flow rate of nitrogen to the dry pump for safety reasons, you should therefore fit suitable measurement equipment in the nitrogen supply pipeline. If you fit a rotameter, ensure that it is suitable for use with nitrogen and that it is correctly calibrated.

If the nitrogen supply to the iH system fails, a warning message will be shown on the Pump Display Terminal (if fitted) and will be sent to the Interface Module(s) connected to the iH system. Ensure that your installation is configured so that it remains safe if there is a failure of the nitrogen supply to the iH system.

If an alarm condition is detected (and the iH system is not configured to 'run til crash' refer to Section 3.4) the iH system will shutdown automatically. You must ensure that your installation remains safe if the iH system shuts down automatically.



Please refer to the appropriate Section in A590-00-860 for important safety information when you see a warning symbol.

3 OPERATION



3.1 Start-up



CAUTION



The system is designed to ride through short term power interruption and to automatically restart once the power is restored.



CAUTION

Do not operate the pump if the pipeline is restricted or blocked as the pump will not operate correctly and may be damaged.

Refer to Section 1.1 and 2.6.

1. Switch on the cooling-water and nitrogen supply.
2. Switch on the electrical supply.
3. Check that the exhaust-extraction system is not restricted, and that any valves in the exhaust-extraction system are open.

The pump can be started using either the iTIM, the PDT or the IM.

iTIM and IM operation:

4. Use your control equipment to set the pump start/stop signal to the interface connector and check that the Running LED is illuminated.
 - Control must be taken with the iTIM. The message 'iTIM IN CONTROL' will be displayed on the PDT if connected.

PDT operation:

5. If the system is to be operated using the PDT;
 - Connect the PDT to the required PDT connection, front (Figure 6, item 4).
 - Press CONTROL button, press ENTER button, LOCAL CONTROL green LED illuminates.
 - Press START button.
 - Press ENTER.
 - The system will start and the Running LEDs will be illuminated.

3.2 Status indicators

Refer to Figure 6.



Please refer to the appropriate Section in A590-00-860 for important safety information when you see a warning symbol.

iH Dry Pumping System



3.3 Manual shut-down



The pump can be shutdown using either the iTIM, the PDT or the IM. Note that only the item in control can stop the pump (refer to Section 1.1).

iTIM and IM operation:

1. Use your control equipment to reset the pump start/stop signal to the interface connector. The Running LED (Figure 6, item 2) will then go off, and the pump running status output signal will open.

PDT operation:

CAUTION

If you stop the pump without the nitrogen purge cycle i.e. using the EMS button, on processes that have condensable or solid by-products then the pump may not restart.

1. Use the PDT to select Auto or Fast shut-down mode, both introduce nitrogen purge cycle.

If the pump is not going to be required for some time, switch off the electrical supply and the cooling-water supply.

3.4 Automatic shut-down

CAUTION

If you select 'Run 'til crash', the pump(s) can be damaged and you may invalidate any warranties on the iH system equipment.

Normally, if an alarm condition exists, the iH control system will shutdown the iH system. If required you can request 'run 'til crash' operation. In this mode of operation, most alarm conditions will be ignored and the pump(s) will continue to operate. For safety reasons the following alarms will shut-down the iH system even if you have selected 'run til crash':

Note: 'Run 'til crash' is automatically reset to 'off' when the electrical supply is removed.

- HCDP CURRENT HIGH/LOW (error numbers 310 and 312).
- HCDP THERMISTOR HIGH (error number 512).
- EXHAUST PRESSURE (error number 3912).

On an iH160, 1000 or 1800 system, the following alarms will cause only the HMB pump to shut down, provided 'run til crash' is not selected:

- HMB POWER HIGH/LOW (error numbers 810 and 812).
- HMB PHASE IMBALANCE (error number 1012).



Please refer to the appropriate Section in A590-00-860 for important safety information when you see a warning symbol.

iH Dry Pumping System

On an iH160, 1000 or 1800 system, the following alarms will cause only the HMB pump to shut down, whether ‘run til crash’ is selected or not:

- HMB CURRENT HIGH LOW (error numbers 710 and 712).
- HMB THERMISTOR HIGH (error number 912).

3.5 Unplanned shutdown and alarms

The iH system is fitted with a number of pump protection sensors (refer to Table 1) that will give warnings and alarms. The decision on whether or not to shutdown the pump is left with the tool.

If the iH system has an unplanned shutdown, ensure that the cause of the shutdown is identified and rectified before restarting. If you are in any doubt, please call a BOC Edwards Service Engineer.

Safety sensor	Shut-down condition
HCDP pump-motor thermistor	When the thermistor in the HCDP pump-motor indicates that the temperature of the pump-motor is nominally 150°C.
HMB pump-motor thermistor*	When the thermistor in the HMB pump-motor indicates that the temperature of the pump-motor is nominally 150C.
Exhaust pressure transducer	When the pressure in the exhaust pipeline is 9 Psig or higher.
Photohelic switch#	When the extraction from the exhaust enclosure is lost.

Table 1 - Safety sensors

* iH600/1000/1800 systems only

Accessory

3.6 Emergency stop

Note: The emergency stop switch is not an electrical isolator.

Note: The use of emergency stop will not automatically shut down the load lock pump (if fitted); you must shut down the load lock pump separately.

To shut down the iH system in an emergency, press the emergency stop switch (Figure 6, item 1). Alternatively, you can operate the emergency stop controls in your own control system if you have connected your emergency stop circuit to the iH system as described in Section 2.10.

When emergency stop is selected:

- The pump (and the booster pump) is switched off.
- The solenoid-valve(s) in the Gas Module close, to switch off the supply of nitrogen to the pump.



Please refer to the appropriate Section in A590-00-860 for important safety information when you see a warning symbol.

iH Dry Pumping System

- The solenoid-valve(s) in the temperature control manifold(s) de-energise with loss of temperature control.
- The Pump Display Terminal will display 'STOP ACTIVATED'. (If connected)
- The Running LED will go off.
- The Alarm LED illuminates.

3.7 Restart the pump after an emergency stop or automatic shut-down

Note: If the iH system has automatically shut down because of high pump power, check that the pump is free to rotate before you restart the iH system: refer to the Web.

If you have used the emergency stop switch on the front panel to shut down the iH system, you must reset the emergency stop switch before you can restart the iH system. Turn the emergency stop switch to reset it, then restart the iH system as described in Section 3.1.

If the iH system has been automatically shut down because of an alarm condition, the alarm condition must be rectified before you can restart the iH system. Restart the iH system as described in Section 3.1.

3.8 Single equipment monitor (SEM)

CAUTION

Ensure that you use the correct configuration setpoints for your application. If you do not, the iH system may be damaged during operation.

If there is an SEM connected to your iH system, you are able to download configuration sets, which contain preset configuration values, for example setpoints. Contact BOC Edwards or go to the Web for more details.



Please refer to the appropriate Section in A590-00-860 for important safety information when you see a warning symbol.



4 MAINTENANCE



4.1 Safety and maintenance frequency



The iH system requires little user maintenance. Safety sensors fitted to the iH system do not require routine maintenance. The maintenance operations you can carry out are described in the following sections, any other maintenance must be carried out by BOC Edwards service centres (refer to Section 6). The frequency of maintenance operations depends on your process. Adjust the frequency of maintenance operations according to your experience.



When you maintain the iH system, use BOC Edwards maintenance and service kits. These contain all of the necessary seals and other components necessary to complete maintenance operations successfully. Ensure that your nitrogen and cooling-water supplies comply with the Technical Data Section (A590-00-840) and that they are connected in parallel. Contact BOC Edwards or refer to the Web.



4.2 Relocate the system for maintenance

CAUTION



Drain the cooling-water from the iH system, if you will transport or store it in conditions where the cooling-water could freeze. If you do not, cooling-water may freeze in the iH system and damage the pump(s) and/or the cooling-water pipelines.



If you want to remove the iH system from its operating location and move it to another location where you will do maintenance, use the following procedure:



1. Purge the iH system and shut down the iH system as described in Section 3 and allow the iH system to cool down.
2. Isolate the power by disconnecting the mating-half from the electrical supply connector, then isolate the water and the gas purge supply.
3. Switch off your nitrogen and cooling water supplies. Disconnect the nitrogen supply, taking care as any trapped gas under pressure is released. Disconnect the cooling-water supply followed by the cooling-water return.
4. Disconnect the inlet and outlet from the vacuum and exhaust systems and fit blanking caps.
5. If necessary, disconnect the iH air-extraction port from your factory extraction system.
6. If necessary disconnect any accessories from the iH system.
7. Adjust the levelling feet so that the iH system rests on the castors.
8. Move the iH system to the location where you will do maintenance.

After maintenance is complete, re-install the iH system as described in Section 2.



Please refer to the appropriate Section in A590-00-860 for important safety information when you see a warning symbol.

iH Dry Pumping System

4.3 Cleaning the pump

CAUTION

Do not use cleaning materials based on strong alkalis, aggressive or chlorinated solvents. Do not use cleaning materials containing abrasives.

Inspect the pump monthly and, if necessary, wipe the outside clean with a soft lint free cloth and a proprietary cleaning material based on demineralised water or isopropanol.

4.4 General maintenance

The following maintenance can be carried out on the system, refer to Web and / or contact BOC Edwards for details and training:

- Check purge gas flow rates
- Inspect & clean exhaust pipe, elbow, and check valve
- Check oil levels
- Change oil
- Check TMS operation



4.5 Replace a fuse

You can only change the low voltage fuses F8 to F10 (figure 4, items 3 to 5) for the d.c. electrical supply, the iM interface and communications module and the emergency stop circuit. Only change a fuse if you have identified and rectified the cause of the failure.

To change a fuse, refer to Figure 4 and use the following procedure. If the fuse immediately fails when you replace it, there may be an electrical fault: contact your supplier or BOC Edwards for advice.

1. Use a flat-bladed screwdriver to undo the fuse holder (3 to 5) by a 1/4 of a turn, then remove the fuse holder from the Electrics Box.
2. Remove the failed fuse from the fuse holder.
3. Fit a new fuse of the correct rating in the fuse holder. Refer to Technical Section, Table 6 for the fuse ratings.
4. Refit the fuse holder in the Electrics Box, then use a flat-bladed screwdriver to turn the fuse holder clockwise by a 1/4 of a turn to secure it in place.

4.6 Inspect the connections, pipelines, cables and fittings

1. Remove the enclosure side and top panels.
2. Check that all the connections are secure; tighten any loose connections. Inspect all cables, pipelines, hoses and connections and check that they are not corroded or damaged and do not leak; repair or replace any pipelines, hoses and connections that are corroded or damaged, or which leak.
3. Refit the enclosure side and top panels.



Please refer to the appropriate Section in A590-00-860 for important safety information when you see a warning symbol.



5 TRANSPORTATION, STORAGE AND DISPOSAL

5.1 Transportation

Follow the procedure laid out in Section 5.2 and then read form HS1 and fill out form HS2, which can be found at the back of this manual.

5.2 Storage

CAUTION

Drain the cooling-water from the iH system, if you will transport or store it in conditions where the cooling-water could freeze. If you do not, the cooling-water may freeze in the iH system and damage the pump(s) and/or the cooling-water pipelines.

Store the iH system as follows:

1. Follow the procedure set out in Section 4.2.
2. Store the iH system in clean dry conditions until required.
3. When required for use, prepare and install the iH system as described in Section 2 of this manual.



5.3 Disposal

BOC Edwards products are supported by a world-wide network of BOC Edwards Service Centres. Each Service Centre offers a wide range of options including disposal. Refer to Section 6.2 for more information.

Pump system materials suitable for recycling include cast iron, steel, SG iron, PTFE, stainless steel, brass, aluminium, zinc alloy, nickel, mild steel, ABS.

Take particular care with the following:

- Fluoroelastomers which may have decomposed as the result of being subjected to high temperatures.
- Components which have been contaminated with dangerous process substances.



Please refer to the appropriate Section in A590-00-860 for important safety information when you see a warning symbol.

6 SERVICE, SPARES AND ACCESSORIES



6.1 Introduction

Note: Whenever you return the iH system to a BOC Edwards Service Centre or other BOC Edwards company, you must comply with the requirements of Section 6 and with the requirements of the Return of BOC Edwards Equipment Procedure (refer to forms HS1 and HS2 at the end of Important Safety Information).

Note: You must not drain the oil from the iH pump. You must clearly state the pump is full of oil when you complete form HS2.

BOC Edwards products, spares and accessories are available from BOC Edwards companies in Belgium, Brazil, Canada, China, France, Germany, Israel, Italy, Japan, Korea, Singapore, Switzerland, United Kingdom, U.S.A and a world-wide network of distributors. The majority of these centres employ Service Engineers who have undergone comprehensive BOC Edwards training courses.

Order spare parts and accessories from your nearest BOC Edwards company or distributor. When you order, please state for each part required:

- Model and Item Number of your equipment
- Serial number (if any)
- Item Number and description of the part.

6.2 Service

BOC Edwards products are supported by a world-wide network of BOC Edwards Service Centres. Each Service Centre offers a wide range of options including: equipment decontamination; service exchange; repair; rebuild and testing to factory specifications.

Equipment that has been serviced, repaired or rebuilt is returned with a full warranty. Your local Service Centre can also provide BOC Edwards engineers to support on-site maintenance, service or repair of your equipment.

For more information about service options, contact your nearest Service Centre or other BOC Edwards company.



Please refer to the appropriate Section in A590-00-860 for important safety information when you see a warning symbol.

iH Dry Pumping System

6.3 Ordering accessories

Accessory	Item Number
Pump display terminal 5-way XLR plug(PDT)	D372-80-700
PDT extension cables XLR 5 way	
3m	D373-70-591
5m	D373-70-592
10m	D373-70-595
15m	D373-70-596
25m	D373-70-597
Exhaust temperature sensor	A532-07-000
Active gauge connection kit	D372-41-000
iTIM	
E73+A1+T1	D374-20-000
E73+A1+T1 serial	D374-21-000
MCM+L1	D374-22-000
MCM+L1 serial	D374-23-000
PC interface kits	
Desktop	D372-18-100
Laptop (USA)	D372-18-200
Laptop (Europe)	D372-18-300
Laptop (UK)	D372-18-400
Laptop (Japan)	D372-18-500
PCMCIA Laptop	D372-17-000
Nitrogen flow switch	A532-54-000
IH Disconnect box	U20000445
IH Photohelic switch / gauge kit	U30004021
Heated exhaust purge kit (HTX variants)	A533-24-015

Table 2 - Accessories



Please refer to the appropriate Section in A590-00-860 for important safety information when you see a warning symbol.

iH Dry Pumping System

TMS control unit (HXT variants) 230V, 50Hz, single phase 208V, 60hZ, 3-phase 200V, 50/60Hz, 3-phase	Y142-01-000 Y142-02-000 Y142-03-000
IH80, 600, & 1000 Enclosure extraction fan kit	A505-39-000
PDT Holster	D372-09-800
PDT Adaptor, 5-way XLR plug/RJ12 socket	D373-70-526

Table 2 - Accessories

Technical data

iH Dry Pumping Systems

Description	Item Number
iH80	A590-00-xxx
iH160	A590-10-xxx
iH160HTX	A590-12-xxx
iH600	A590-20-xxx
iH1000	A590-30-xxx
iH1800	A590-40-xxx
iH1800HTX	A590-42-xxx
iH1800NRV	A590-50-xxx
iH1800NRV HTX	A590-52-xxx

Where xxx is as follows:

460V, 60Hz, 3 phase	908
200 / 208V, 50/60Hz, 3 phase	945
380 / 415V, 50Hz, 3 phase	946
230V, 60Hz, 3 phase	957

 **BOC EDWARDS**

<http://www.bocedwards.com>



Technical Data

1 iH DRY PUMPING SYSTEM

1.1 Technical data

Type	Characteristics	iH80	iH600	iH1000	iH160	iH1800	Units
General	Dimensions (L (to exhaust enclosure) x W x H (to inverter))*	776 (909) x 390 x 529	776 (909) x 390 x 839	776 (909) x 390 x 839 (992)	776 (909) x 390 x 529 (783)	986 (1059) x 470 x 888 (1094)	mm
	Mass (excluding packaging)	240	415	430	244	502	kg
	Noise level (ultimate)	<64	<67	<69	<64	<69	dB(A)
	Vibration level at inlet	<1.8	<1.8	<1.8	<1.8	<1.8	mm s ⁻¹
	Initial force to push the pump	8	16	20	8	25	kg
	Sustained force to push the pump	5	7	8	5	10	kg
	Earth leakage	<1.1	<1.1	<3	<3.8	<6.8	mA
	Warm up time to nominal pumping performance	15	15	15	15	15	minutes
Minimum warm up time to process gas pumping	4	4	4	4	4	hours	
Performance 50Hz / 60Hz	Typical peak pumping speed	86 / 103	518 / 600	950 / 1000	165	1800	m ³ h ⁻¹
	Ultimate (shaft seal purge only)	3x10 ⁻² /1x10 ⁻²	2x10 ⁻³ /7x10 ⁻⁴	2x10 ⁻³ /1x10 ⁻³	1x10 ⁻²	1x10 ⁻³	mbar
	Maximum inlet pressure	Atmospheric	Atmospheric	Atmospheric	Atmospheric	Atmospheric	
	Maximum operating time at maximum inlet pressure	Continuous	1	Continuous	Continuous	Continuous	hour
Water cooling system	Minimum flow rate required	2	4	4	2	4	l min ⁻¹
	Typical heat removed from the system	2.5	3.2	3.2	2.5	3.2	kW
Connections	Pump inlet flange (bolted)	ISO63	ISO100	ISO100	ISO63	ISO160	
	Exhaust gas outlet	NW40	NW40	NW40	NW40	NW40	
	Extraction port	105	105	105	105	50	mm dia

Table 1 - Technical data

* Refer to Web for installation drawings.

Technical Data

Type	Characteristics	All	HTX only	Units
Gas system	Nitrogen supply pressure range	1.4 to 6.9	3.8 to 6.9	bar gauge
	Stability of supply	+/-2.4	+/-2.4	bar gauge
	Nitrogen supply quality	<0.01	<0.01	µm
	Nitrogen flow rate	44	76	slm
	Gas module pressure range	1	1	bar gauge
	Pressure transducer accuracy	+/-0.0041 @ 0.4	+/-0.0041 @ 0.4	bar gauge

Table 2 - Technical data

1.2 Electrical data

Supply voltage and frequency			200-208V 50Hz	200-208V 60Hz	230V 60Hz	380-415V 50Hz	460V 60Hz
iH80 / iH160	HCDP	Full load (Amp)	14.4	14.9	14.4	7.2	7.2
		Motor rating (kW)	2.9	3.5	3.5	2.9	3.5
	Max power input to motor (kW)		3.65	4.48	4.48	3.65	4.48
iH600 / iH1000	HCDP	Full load (Amp)	14.4	14.9	14.4	7.2	7.2
		Motor rating (kW)	2.9	3.5	3.5	2.9	3.5
	HCMB	Full load (Amp)	11.8	11.8	11.7	5.9	5.8
		Motor rating (kW)	2.2	2.6	2.6	2.2	2.6
	Max power input to both motors (kW)		6.51	7.8	7.8	6.51	7.8
iH1800	HCDP	Full load (Amp)	14.4	14.9	14.4	7.2	7.2
		Motor rating (kW)	2.9	3.5	3.5	2.9	3.5
	HCMB	Full load (Amp)	14.4	14.9	14.4	7.2	7.2
		Motor rating (kW)	2.9	3.5	3.5	2.9	3.5
	Max power input to both motors (kW)		7.3	8.96	8.96	7.3	8.96

Table 3 - Electrical data

1.3 Loading

		iH80	iH600	iH1000	iH160	iH1800
Centre of gravity	A	661	661	661	661	661
	B	322	309	314	304	325
	C	159	163	163	163	198
	D	302	302	302	302	382
	E	293	466	481	364	528
Leveling loads	1	75	103	118	70	133
	2	66	119	115	65	125
	3	51	75	90	50	113
	4	48	118	107	60	132

Table 4 - Centre of gravity and levelling foot loads (Refer to Figure 1)

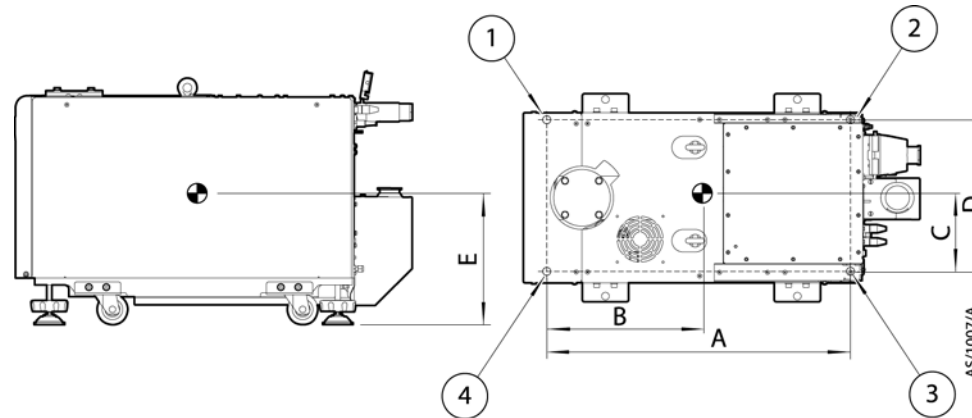

Figure 1 - Centre of gravity and levelling foot loads

1.4 Connections

Description	Mating connector description / external supply rating	Internal supply rating
Electrical supply connector 1 - Phase 1 (R) 2 - Phase 2 (S) 3 - Phase 3 (T)	Harting HAN-K-4/2 16mm ² wire, 18 to 27 mm cable OD	
Pump display terminal connector	XLR type 5-way plug	24 V d.c. 0.75 A
Network LON communications connector	XLR type 4-way plug	24 V d.c. 0.75 A
Exhaust gas management interface 1 - normally open and 3 - common 2 - normally open and 4 - normally closed 3 - normally open and 6 - common	DIN type 6-pin plug 30 V a.c. 1 A 30 V a.c. 1 A 60 V d.c. 0.5 A	
Active gauge connector++	SCC68 socket	
Exhaust TMS power supply +	BOC Edwards TMS type	
Tool interface module connector / EMS 1 & 2 - linked, remove - normally closed 3 & 4 - isolated auxiliary contacts 5 - continuous output 6 - return	XLR type 6-way plug 24 V a.c. 625mA	
Tool interface adapter (iTIM)	D type 15-way plug	
External emergency stop switch		24 V a.c. 5 A (load 700mA inductive)

Table 5 - iH connector types

+ HTX variants only

++ Optional accessory

Technical Data

1.5 General data

Item	Description	Rating	Units
Electrical	Supply voltage 3-phase	200-208 / 380-415 V, 50 Hz a.c. 200-208 / 230 / 460 V, 60 Hz a.c.	
	Recommended fuse / isolator rating	Full load current rating, refer to table 3. Class CC fuse rated to 600V.	
	Voltage tolerance range	+/- 10%	V
	208 V and 415 V, 50 Hz only	+6% / -10%	V
	Installation category	II (IEC 664)	
	Harmonic voltage distortion factor	5%	
	Fuse types and ratings		
	F8	T1.6 A, 250 V	
	F9	T3.15 A, 250 V	
	F10	T5.0 A, 250 V	
Water cooling system	Maximum supply pressure	100	psig
	Minimum supply pressure	36	psig
	Minimum flow rate required	Refer to table 1	
	Supply temperature range	10-30	°C
	Typical pressure differential across supply and return*	15	psig
	Water type	Treated or non-corrosive industrial	
	Maximum particle size	0.03	mm ²
	Acidity	6.5 to 8.0	pH
	Hardness	<100	ppm
	Resistivity	>1	k cm
	Solids (turbidity)	<100	ppm
Materials in contact with cooling water	Stainless steel, Nitrile, PTFE, copper, brass and fluoroelastomer		

Table 6 - Technical data

Technical Data

Connections	Water cooling inlet	3/8" BSP male quick connector	
	Water cooling outlet	3/8" BSP female quick connector	
	Nitrogen inlet	1/4" tube fitting	
Materials in contact with process gas	Pump, shaft and rotors	Cast Iron, Steel, SG iron	
	Seals	PTFE and fluoroelastomer	
	Gas System	Stainless steel, Aluminium, brass and fluor-elastomer	
Operating conditions	Intended use	Indoor	
	Ambient temperature range:		
	Operating	5 to 40	°C
	Storage	-45 to 55	°C
	Relative humidity	10 to 90	%RH
	Maximum operating altitude	2000	m
Pollution degree	2 (IEC 61010)		

Table 6 - Technical data

* With cooling water supply temperature of 20°C and flow rate of 3 l min⁻¹