



OPERATING INSTRUCTIONS

EN

Translation of the original instructions

ASM 182T / ASM 192T / ASM 192T2

High performance leak detector

PFEIFFER  **VACUUM**

A very wide range of leak detectors

Dear customer,

You have just bought a Pfeiffer Vacuum leak detector.

We would like to thank you and we are proud to count you among our customers. This product is a result of the experience acquired over several years by Pfeiffer Vacuum in vacuum and leak detection technology.

The applications of helium leak testing are extremely diversified ranging from high-tech installation maintenance to high-speed testing of industrial products.

Each product of the Pfeiffer Vacuum detector range is designed to meet the specific needs of each application:

- portability,
- high sensitivity,
- pumping capacity,
- pumping type,
- automation and integration in an industrial process.



A very wide range of leak detectors

This product complies with the requirements of European Directives, listed in the Declaration of Conformity contained in G100 of this manual. These Directives are amended by Directive 93/68/E.E.C (E.C. Marking).

Copyright/Intellectual property:

*The use of Pfeiffer Vacuum products are subject to copyright and intellectual property rights in force in any jurisdiction.
All rights reserved, including copying this document in whole or any part without prior written authorization from Pfeiffer Vacuum SAS.*

Specifications and information are subject to change without notice by from Pfeiffer Vacuum SAS.

General contents

ASM 182 T - ASM 192 T - ASM 192 T2

Operating instructions

Preliminary remarks Throughout this operating manual, you could find this type of message “**Summary of screen**  **C 140**”: it refers to a specific chapter of the User’s Manual. Please read it for further information.

Chapter A

INTRODUCTION

- A 100 - Introduction to the ASM 182 / 192 series
- A 200 - ASM 182 T / ASM 192 T - Detector operating principle
- A 201 - ASM 192 T2 - Detector operating principle
- A 300 - Analyzer cell operating principle
- A 400 - Testing methods
- A 401 - About Helium and hydrogen
- A 500 - Operator interface: control panel
- A 600 - Options
- A 700 - Accessories
- A 800 - ASM 182 /192 T - Technical characteristics
- A 801 - ASM 192 T2 - Technical characteristics
- A 900 - ASM 182 T - Dimensions
- A 901 - ASM 192 series - Dimensions

Chapter B

INSTALLATION

- B 100 - Safety instructions
- B 110 - Unpacking - Storage - Transportation
- B 112 - Product labelling
- B 200 - Neutral gas purge and inlet vent connection
- B 210 - ASM 182 - Connecting the detector to the installation
- B 211 - ASM 192 - Connecting the detector to the installation
- B 300 - Controlling the detector with the I/O interface
- B 310 - Controlling the detector with a PC computer through the RS 232 interface
- B 320 - Connecting the detector directly to a printer or another device
- B 400 - ASM 182 series - Before starting up the leak detector
- B 401 - ASM 192 series - Before starting up the leak detector

Chapter C

OPERATION

- C 100 - Factory configuration of the leak detector parameters
- C 110 - Operating principle of the control panel
- C 120 - Setting and maintenance part presentation of the control panel
- C 130 - Access to level  - Password
- C 140 - Summary of screens
- C 200 - Starting up / Switching off the leak detector
- C 210 - How to use the leak detector: 2 methods
- C 211 - Operation of the leak detector
- C 300 - Calibration of the leak detector
- C 301 - Basic internal calibration of the leak detector
- C 302 - Advanced internal calibration of the leak detector
- C 303 - External calibration of the leak detector
- C 304 - Correction factor
- C 305 - Calibrated leak values programming
- C 306 - Adaptor for calibrated leak in sniffing mode
- C 400 - Remote control
- C 410 - Headphone and loudspeaker
- C 430 - 3 masses option
- C 440 - Control panel with graphic interface
- C 450 - Long distance sniffer probe and Helium spray gun

General contents

ASM 182 T - ASM 192 T - ASM 192 T2

Operating instructions

C 500 - Inlet vent
C 510 - Bargraph zoom
C 520 - Audio alarm/Digital voice
C 530 - Cycle end
C 540 - Zero function
C 550 - Memo function
C 560 - Helium pollution prevention
C 570 - Date - Time - Language - Unit
C 580 - Fault / information indicator and display

Chapter D

MAINTENANCE - TROUBLESHOOTING

D 100 - Table of preventive maintenance intervals
D 200 - Maintenance message
D 300 - General troubleshooting guide
D 400 - Symptoms description

Chapter E

MAINTENANCE SHEETS

E 100 - Maintenance operations introduction
E 110 - Access to internal detector components - ASM 182 T
E 111 - Access to internal detector components - ASM 192 T / ASM 192 T2
E 400 - Basic maintenance of the analyzer cell
E 530 - Valves installation and maintenance
E 560 - Replacement of the internal calibrated leak
E 600 - Remote control
E 610 - Long distance sniffer probe and Helium spray gun
E 730 - Starting of the molecular and turbomolecular pumps
E 740 - Greasing molecular and turbomolecular pumps
E 750 - Primary pump maintenance



Chapitre F

COMPONENTS

F 000 - Spare parts instructions of use
F 001 - Service
F 003 - Disposal
F 100 - Tools
F 200 - ASM 182 T - Monitoring and display
F 200 - ASM 192 T / T2 - Monitoring and display
F 300 - ASM 182 T - Power and electrical supply
F 300 - ASM 192 T - Power and electrical supply
F 300 - ASM 192 T2 - Power and electrical supply
F 400 - ASM 182 T - Automatic control system and electronic circuits
F 400 - ASM 192 T - Automatic control system and electronic circuits
F 400 - ASM 192 T2 - Automatic control system and electronic circuits
F 500 - ASM 182 T - Measurement
F 500 - ASM 192 T - Measurement
F 500 - ASM 192 T2 - Measurement
F 600 - ASM 182 T - Pumping
F 600 - ASM 192 T - Pumping
F 600 - ASM 192 T2 - Pumping
F 700 - ASM 182 T - Valves
F 700 - ASM 192 T - Valves
F 700 - ASM 192 T2 - Valves
F 800 - ASM 182 T - Pipes - Connections - Seals
F 800 - ASM 192 T - Pipes - Connections - Seals
F 800 - ASM 192 T2 - Pipes - Connections - Seals

MANUAL REFERENCE: 109438
EDITION: 07 - April 16
Software version:
L113 v3.1 r.02 (ASM 182 T)
L133 v3.1 r.02 (ASM 192 T)
L134 v3.1 r.02 (ASM 192 T2)

General contents

ASM 182 T - ASM 192 T - ASM 192 T2

Operating instructions

F 900 - ASM 182 T - Cover
F 900 - ASM 192 T - Cover
F 900 - ASM 192 T2 - Cover
F 1000 - Options - Accessories

Chapter G

APPENDIX

G 100 - Declaration of conformity
G 200 - ASM 182 T - Wiring diagrams
G 201 - ASM 192 T - Wiring diagrams
G 202 - ASM 192 T2 - Wiring diagrams
G 300 - Analog outputs
G 400 - Long distance sniffer probe user manual
G 500 - Helium spray gun user manual
G 600 - Service
G 800 - Tools

CAUTION

Indicates a potentially hazardous situation which, if not avoided, could result in property damage.

CAUTION

Indicates a potentially hazardous situation which, if not avoided, could result in moderate or minor injury. It may also be used to alert against unsafe practices.

WARNING

Indicates a potentially hazardous situation which, if not avoided, could result in death or severe injury.

DANGER

Indicates an imminently hazardous situation that, if not avoided, will result in death or severe injury (extreme situations).



Introduction

ASM 182 T - ASM 192 T - ASM 192 T2 Operating instructions Detailed contents

Preliminary remarks Throughout this operating manual, you could find this type of message “**Summary of screen**  **C 140**”: it refers to a specific chapter of the User’s Manual. Please read it for further information.

A 100

Introduction to the ASM 182 / 192 series

A 200

ASM 182 T / ASM 192 T - Detector operating principle

- Vacuum circuit
- Pumping capacities
- Test capacities
- Operation in vacuum test mode: 3 stages
- Operation in sniffing mode (LDS)
- Operation in internal calibration mode

A 201

ASM 192 T2 - Detector operating principle

- Vacuum circuit
- Pumping capacities
- Test capacities
- Operation in vacuum test mode
- Operation in sniffing mode (LDS)
- Operation in internal calibration mode

A 300

Analyzer cell operating principle

- Description
- Design and manufacture

A 400

Testing methods

- Overview
- Helium concentration and signal displayed
- Spray method (inboard testing)
- Sniffer method (outboard testing)
- Bombing method

A 401

About Helium and hydrogen

- Helium
- Helium and leak detection: which purity?
- Hydrogenated nitrogen

A 500

Operator interface : control panel



Introduction

ASM 182 T - ASM 192 T - ASM 192 T2 Operating instructions Detailed contents

A 600

Options

- Which options for which model?
- Metal seals
- Inlet port
- Units
- Languages
- 3 masses
- Automatic test chambers
- Roughing system
- Interface board
- Remote control cable length
- Test of gas line
- Stainless steel cover (UCT)
- Control panel with graphic interface
- Control panel racks
- Sniffing
- Cables lengths

A 700

Accessories

- Which accessories for which model?
- Remote control
- Long Distance Sniffer probe
- 10 m/30 feet LDS extension
- Headphone connector
- Transport cart
- Foot pedal for cycle Part No: 100913 command (1.5 m/ 5 feet)
- Calibrated Helium leaks
- Calibration accessory
- Spray probe
- Inlet filters
- Short distance sniffer probe (to be connected to the inlet part of a leak detector)
- Bombing chamber
- Test chambers
- Neutral gas vent line kit
- Bottle handle for cart

A 800

ASM 182 / 192 T - Technical characteristics

A 801

ASM 192 T2 - Technical characteristics

A 900

ASM 182 T - Dimensions

A 901

ASM 192 series - Dimensions

Introduction to the ASM 182/192 series

The ASM 182/192 series are the latest evolutions of Pfeiffer Vacuum leak detectors of which thousands are in successful daily operation throughout the world in various applications like automotive industry, chemical and mechanical, electrical, electronics or packaging industries, quality controls and maintenance of semiconductor process systems, vacuum components quality control, blister tests in the pharmaceutical industry,... These leak detectors offer unique features such as high sensitivity ($5 \cdot 10^{-12}$ mbar l/s) and fast response time in spraying mode.

The ASM 182/192 series are extremely flexible and easy to operate. They provide automatic operation throughout the range from atmospheric sniffer tests, test of long gas line or tubing, large gross leak mode and ultra sensitive vacuum fine leak mode, readily available basic functions, combined digital and analogic display, advanced functions for convenience.

Compact model



Example: ASM 182 T

Console model



Example: ASM 192 T2D+

Introduction to the ASM 182/192 series

Compact model

Compact version for leak testing applications where space is limited. Compactness has always been synonymous with limited performance and poor lay out: Pfeiffer Vacuum has challenge this belief. Transportability: the ASM 182 T/TD+ products are self-contained units which can be installed on a cart for easier manoeuvrability.

ASM 182 T

Using its rotary vane pump 2021SD, Pfeiffer Vacuum designed an unmatched concept delivering high performance in a well laid out system.

ASM 182 TD+

Its well-proven concept for the roughing/backing oil-free pump (frictionless compact multi-stage roots) has been designed to achieve high roughing capacity (25 m³/h - 15 cfm) with minimum dimensions.

Console model

Comfortable workstation and several roughing configurations for extended and adapted capability.

ASM 192 T/T2

Console version ASM 182 T with extended pumping speed capability (T2) or leak testing large chamber.

ASM 192 TD+

Console version ASM 182 TD+.

ASM 192 T2D+

Console version ASM 192 T2D+ with a extended pumping speed capability for leak testing large chambers.

THE VERSIONS ACCORDING THE DETECTOR TYPES

PUMPING	COMPACT VERSION	CONSOLE VERSION
1 Rotary vane pump RVP 2021 1 Hybrid pump TMP 5154	ASM 182 T	ASM 192 T
2 Rotary vane pumps RVP 2021 1 Hybrid pump TMP 5154		ASM 192 T with 40 m ³ /h roughing option
1 Rotary vane pump RVP 2021 1 Turbomolecular pump ATP 100 1 Hybrid pump TMP 5154		ASM 192 T2
2 Rotary vane pumps RVP 2021 1 Turbomolecular pump ATP 100 1 Hybrid pump TMP 5154		ASM 192 T2 with 40 m ³ /h roughing option
1 Dry pump Type ACP 28 1 Molecular drag pump MDP 5011 1 Hybrid pump TMP 5154	ASM 182 TD+	ASM 192 TD+
1 Dry pump Type ACP 28 1 Molecular drag pump MDP 5006 HDS 1 Turbomolecular pump ATP 100 1 Hybrid pump TMP 5154		ASM 192 T2D+

ASM 182 T / ASM 192 T detector operating principle

Vacuum circuit

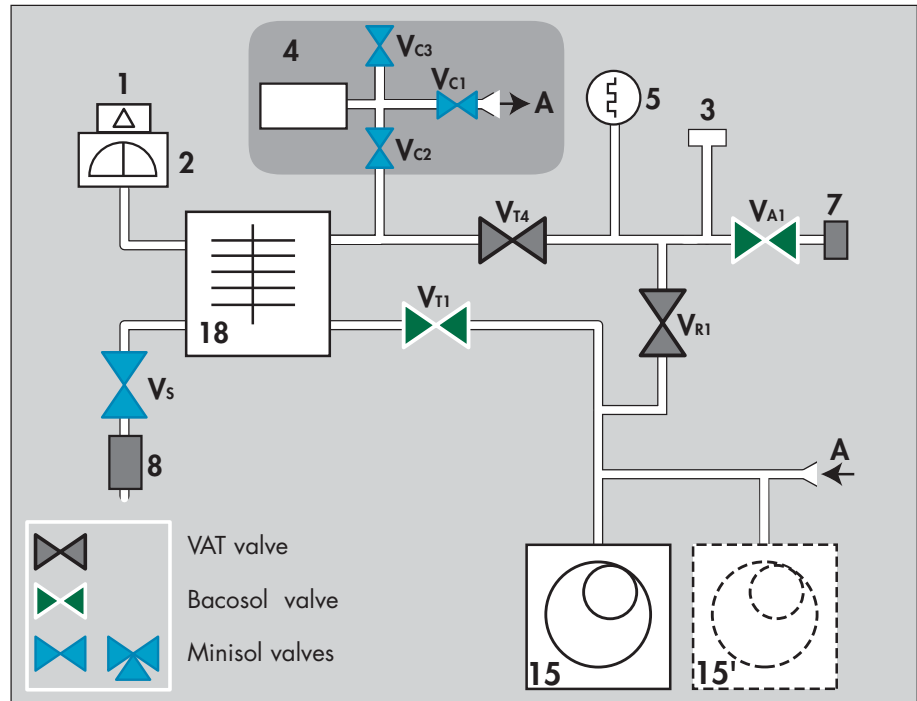

Reference correspondence between valve/vacuum block marks E 530

1	Preamplifier	VA1	Inlet vent valve (4 points)
2	Analyzer cell	VR1	Roughing valve (2 points)
3	Detector inlet port	VT1	Exhaust valve (5 points)
4	Internal calibrated leak	VT4	Detection valve (3 points)
5	Inlet pressure gauge (PI3C)	Vs	Sniffing valve (9 points)
7	Vent connector	Vc2	Calibration valve - Detection (6 points)
8	Long distance sniffer connector	Vc1	Calibration valve - Roughing (7 points)
15	Roughing primary pump (RVP 2021)	Vc3	Calibration valve - Inlet vent (8 points)
15'	Second roughing primary pump (ASM 192 T with roughing option only)		
18	Detection turbomolecular pump (TMP 5154)		

Pumping capacities

- **ASM 182 T:** 20 m³/h (12 cfm) roughing (primary pump RVP 2021). Helium pumping speed at inlet port: 4.4 l/s.
- **ASM 192 T standard:** 25 m³/h (15 cfm).
- **ASM 192 T with roughing option:** 40 m³/h (24 cfm).

Test capacities

Short test cycle.
Quick response time.
Auto-calibration with integrated calibrated leak.

ASM 182 T / ASM 192 T detector operating principle

Operation in vacuum test mode: 3 stages

Note: Only operational parts are represented.

1 Primary roughing

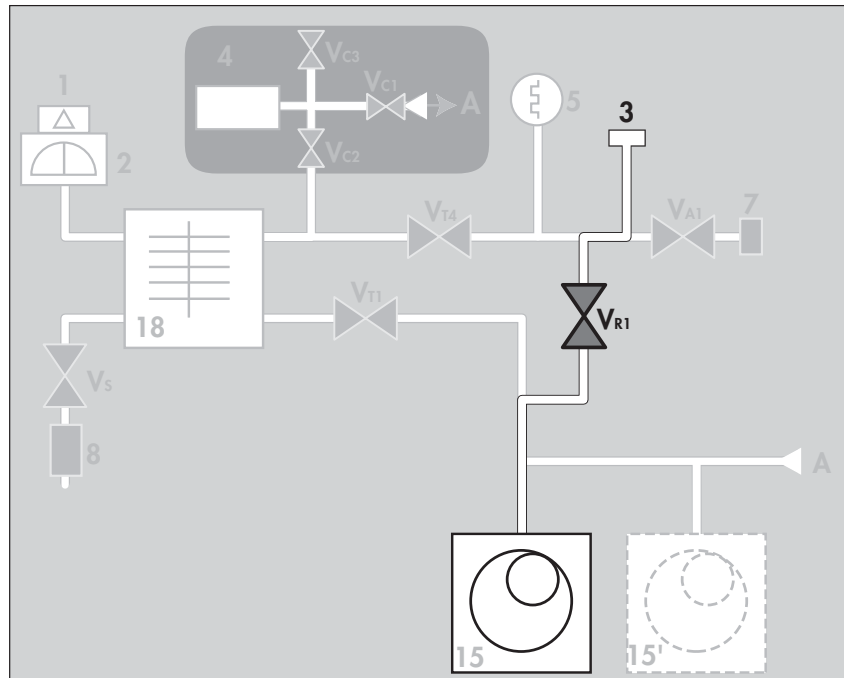

2 Gross leak test mode
 2×10^{-2} mbar < Inlet Pressure < 6 mbar

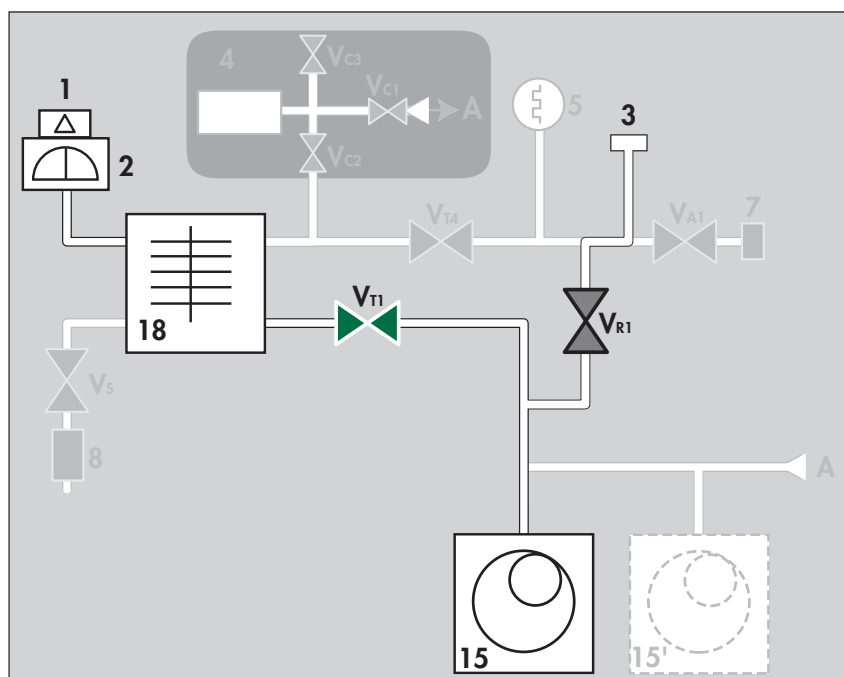

ASM 182 T / ASM 192 T detector operating principle

Operation in vacuum
test mode: 3 stages
(ctd)

3 High sensitivity test mode (HS)

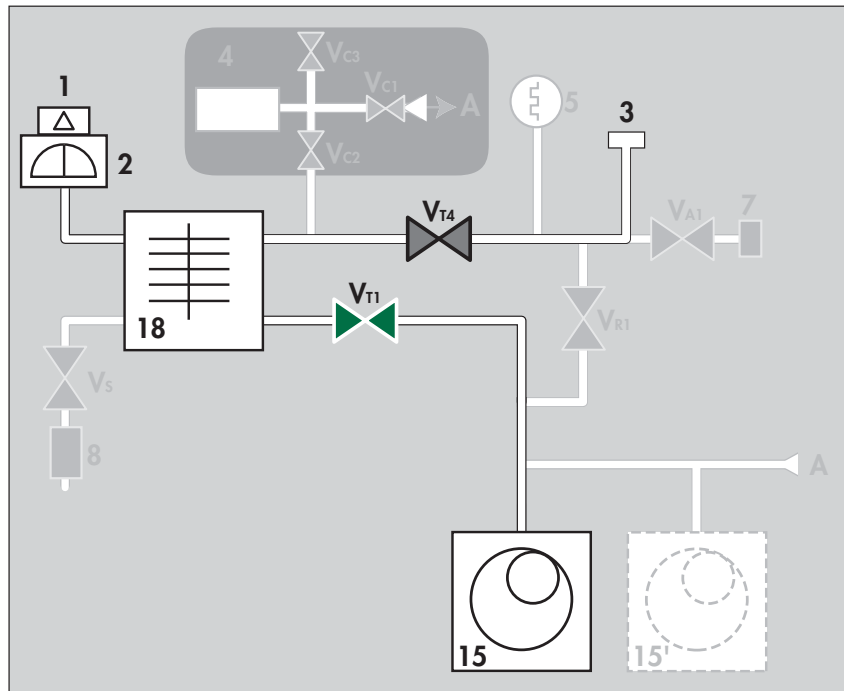

Operation in
sniffing mode (LDS)

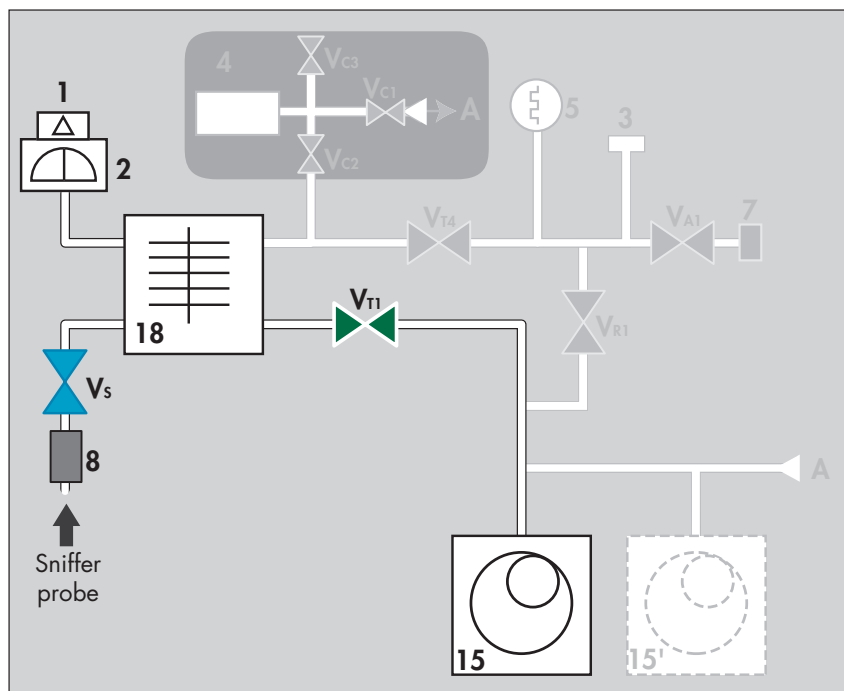

ASM 182 T / ASM 192 T detector operating principle

Operation in internal calibration mode

1 Roughing of calibrated leak

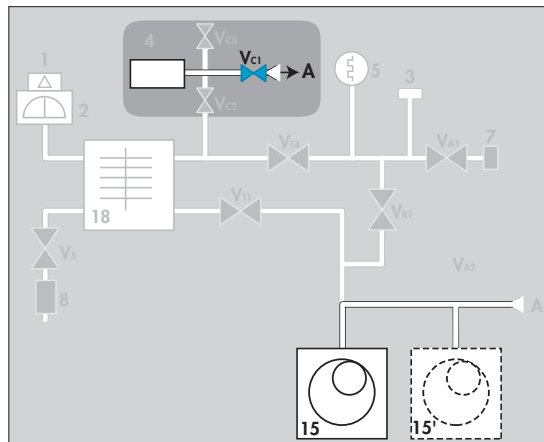

2 Calibration

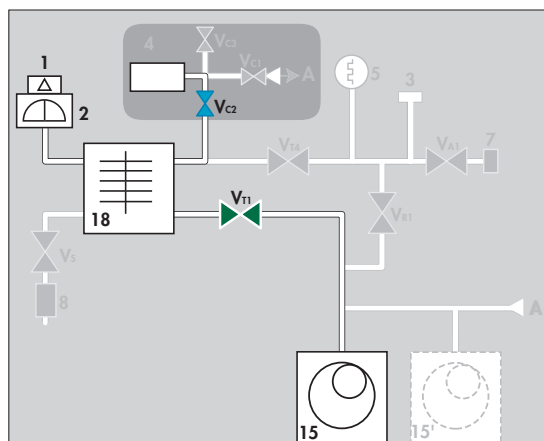

3 Venting of calibrated leak
The leak is returned to atmospheric pressure.

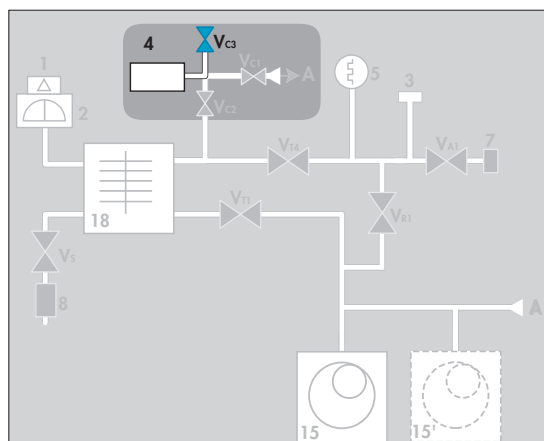

ASM 192 T2 detector operating principle

Vacuum circuit

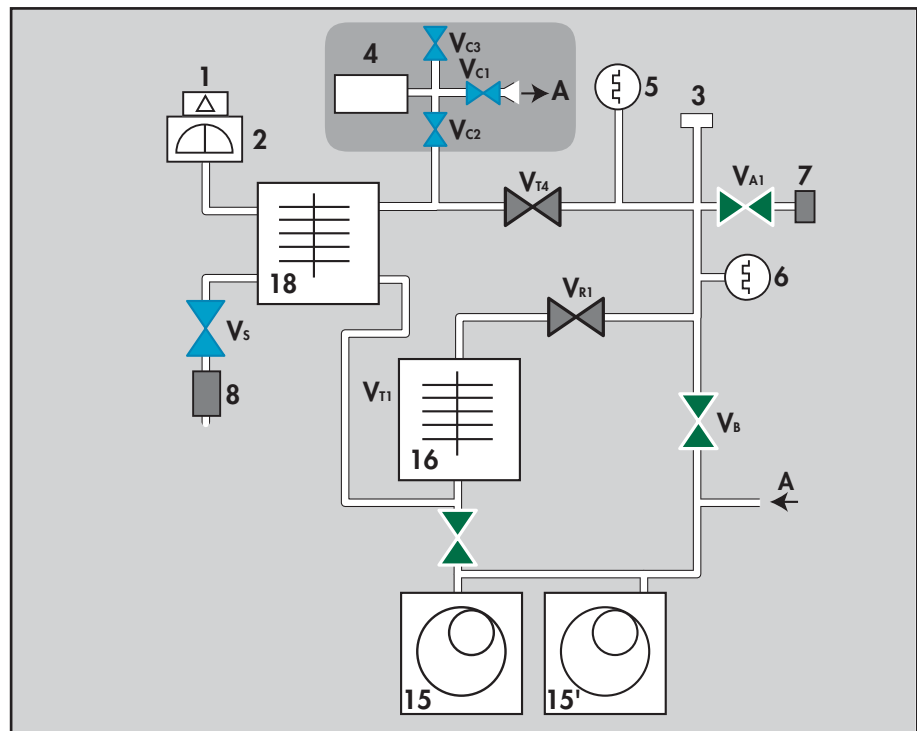

Reference correspondence between valve/vacuum block marks E 530

1	Preamplifier	16	Roughing turbomolecular pump (ATP 100)
2	Analyzer cell	18	Detection turbomolecular pump (TMP 5154)
3	Detector inlet port	V _{A1}	Inlet vent valve (4 points)
4	Internal calibrated leak	V _{R1}	Roughing valve (2 points)
5	Inlet pressure gauge (PI3)	V _B	By-pass valve (1 points)
6	Outlet pressure gauge (PI1)	V _{T1}	Exhaust valve (5 points)
7	Vent connector	V _{T4}	Detection valve (3 points)
8	Long distance sniffer connector	V _S	Sniffing valve (9 points)
15	Roughing primary pump (RVP 2021)	V _{C2}	Calibration valve - Detection (6 points)
15'	Second roughing primary pump (RVP 2021)	V _{C1}	Calibration valve - Roughing (7 points)
		V _{C3}	Calibration valve - Inlet vent (8 points)

Pumping capacities

50 m³/h (30 cfm) roughing (2 primary pumps RVP 2021) + 100 l/s (turbomolecular pump ATP 100).
Helium pumping speed at inlet port: 20 l/s.

Test capacities

Short test cycle on big volumes.
Quick response time on big volumes.
Auto-calibration with integrated calibrated leak.

ASM 192 T2 detector operating principle

Operation in vacuum test mode

Note: Only operational parts are represented.

1 Stand by

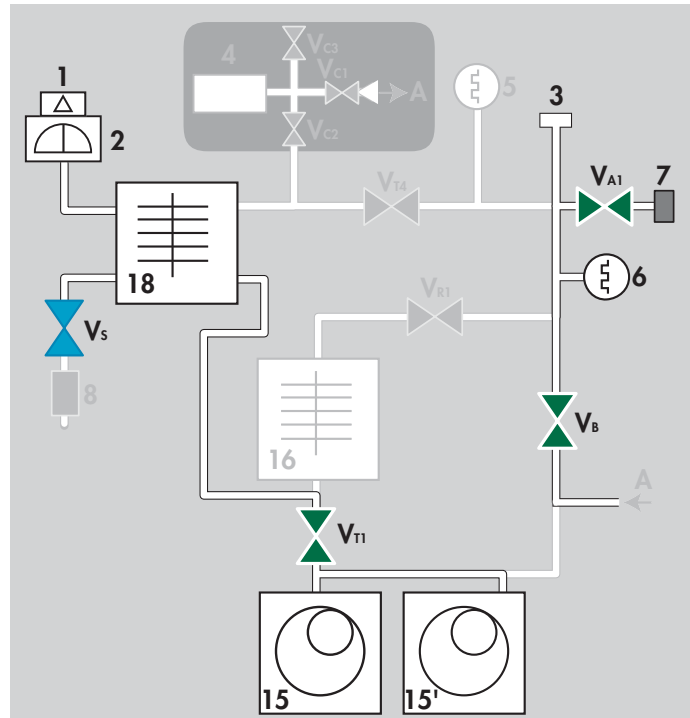

2 Primary roughing

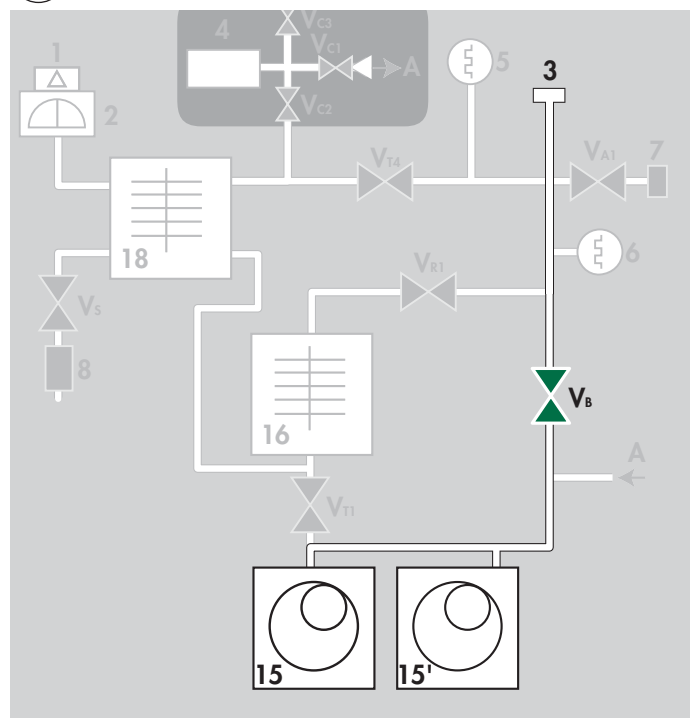

ASM 192 T2 detector operating principle

Operation in vacuum test mode (ctd)

3 Gross leak test mode: 3×10^{-1} mbar < Inlet Pressure < 6 mbar

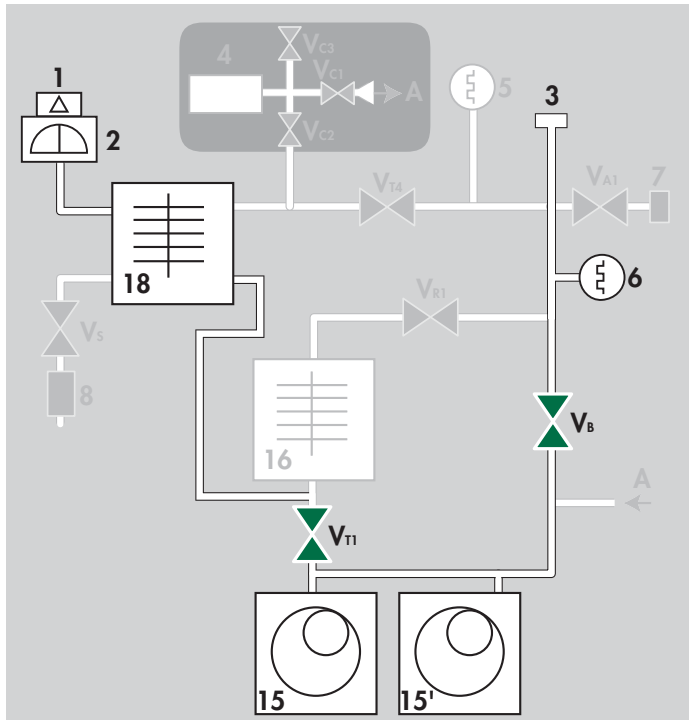

4 Gross leak: 2×10^{-2} mbar < Inlet Pressure < 3×10^{-1} mbar

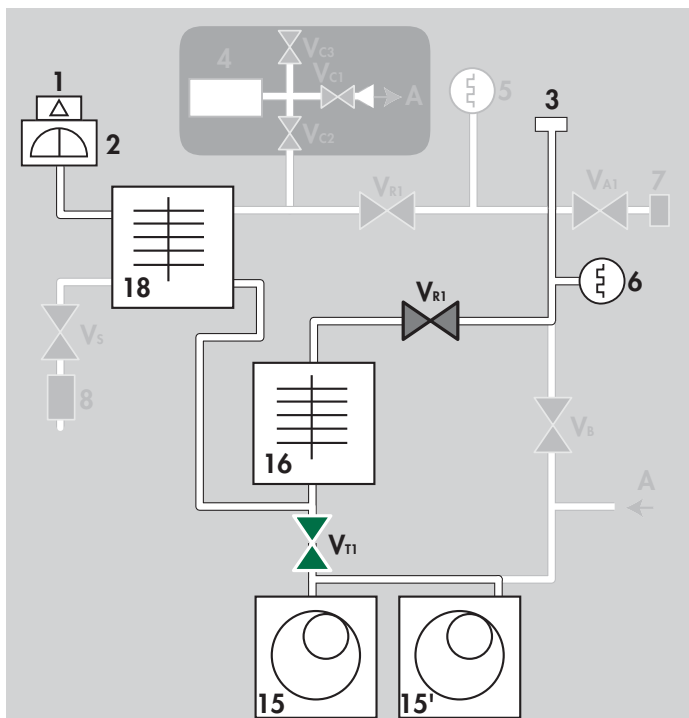

ASM 192 T2 detector operating principle

Operation in vacuum test mode (ctd)

5 High Sensitivity test mode: inlet pressure $< 2 \times 10^{-2}$ mbar

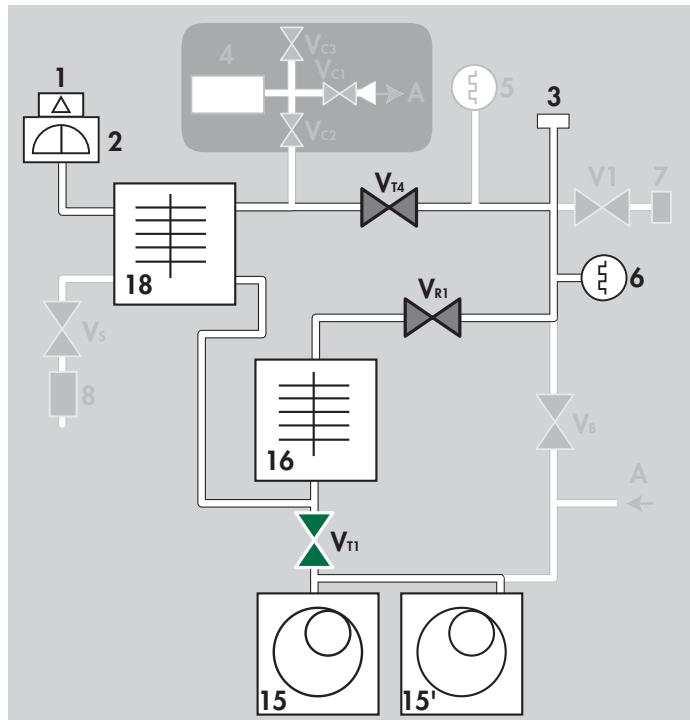

Operation in sniffing mode (LDS)

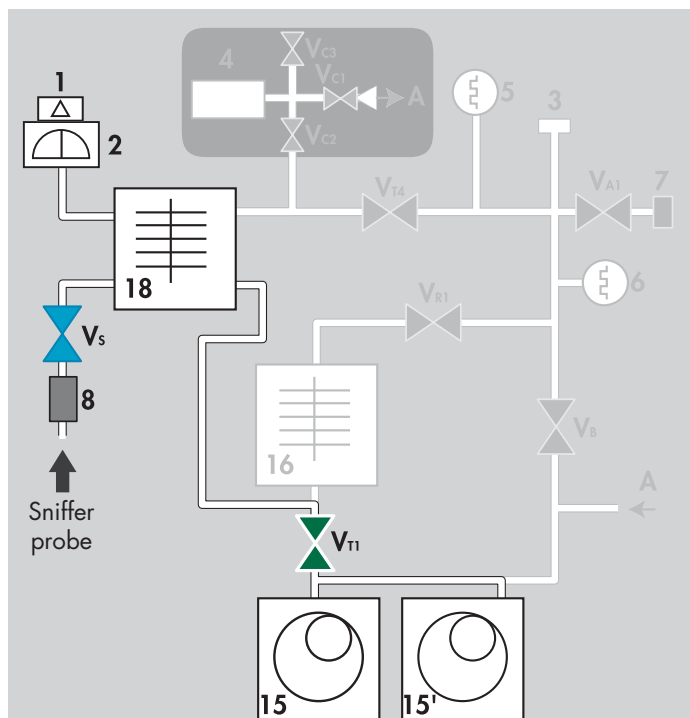

ASM 192 T2 detector operating principle

Operation in internal calibration mode

1 Roughing of calibrated leak

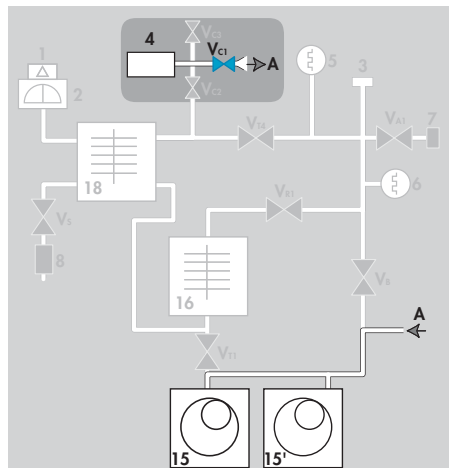

2 Calibration

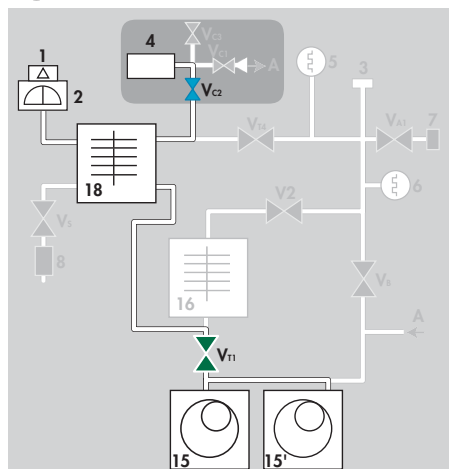

3 Venting of calibrated leak
The leak is returned to atmospheric pressure.

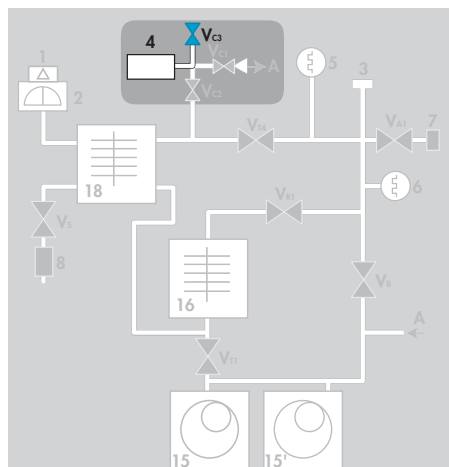

Analyzer cell operating principle

Description The analyzer cell works on the principle of mass spectrometry and is set to the mass of helium ($m/e = 4$).

m/e = atomic mass of the particle/number of electrons lost on ionization

The principle of magnetic deflexion spectrometry is as follows. The neutral molecules of the gas being analyzed pass into an ionization chamber (or source of ions) where they are bombarded by an electron beam generated by a heated tungsten filament. A large number of the molecules are transformed into ions.

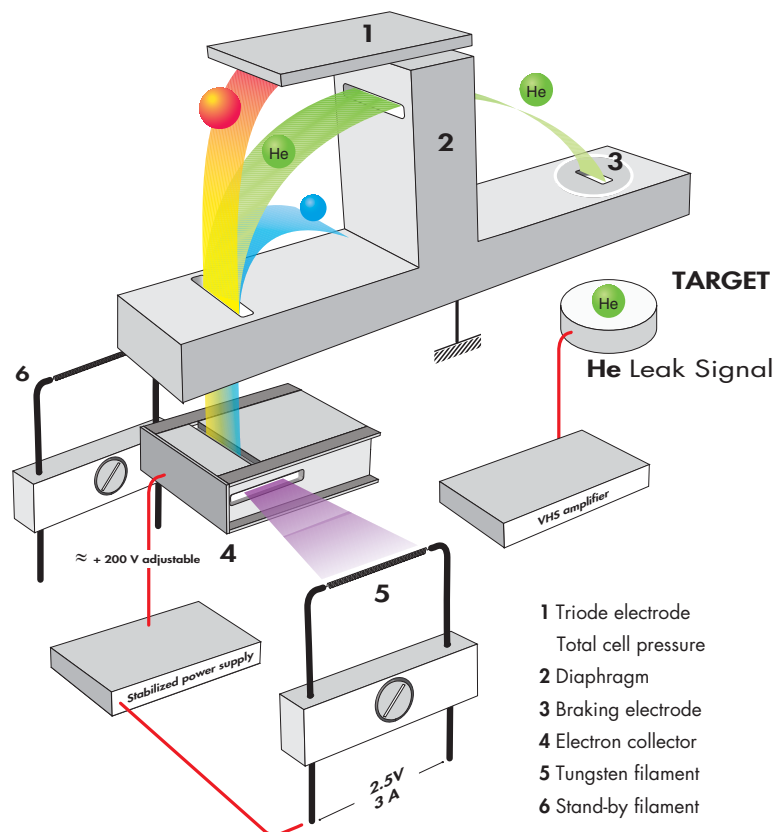

 **Electrons beam**

 **"heavy" ions**

 **Helium ions**

 **"light" ions**

Analyzer cell - functional diagram

Analyzer cell operating principle

Description (continued) These ionized particles are accelerated by an electrical field.

The entire analyzer cell is subject to a magnetic field which has the property of deflecting the trajectories of the ions along different curves according to the masses of those ions (to be more precise, according to their m/e ratios). Thus the ions beam, which contained ions with different masses, is divided into several beams, each containing only ions with the same m/e ratio. The helium ions ($m/e = 4$) are separated from the lighter (H_2^+ or H_1^+ , smaller beams) or heavier ions (N_2^+ or O_2^+ , small beams).

Because there is a constant magnetic field (permanent magnet), the accelerator electrical field is adjusted so that the helium ions ($m/e = 4$) follow a pre-determined trajectory (passing through diaphragms) and arrive on the target at the input to a direct current amplifier.

The current of helium ions is proportional to the partial pressure of helium in the installation and by measuring it we can find the flow rate of the leak that has been detected.

It is essential that the total pressure in the analyzer cell is less than 10^{-4} mbar, so that the trajectories of the electrons and the ions are not disturbed by residual molecules.

Around 10^{-3} mbar there is a risk of damaging the heated filament.

In order to separate the helium ions from «noise» caused by «stray ions», an electrode located in front of the target eliminates the secondary ions with low energies. This electrode is called the «braking electrode».

There is an auxiliary electrode at the top of the cell, shaped like a plate, which collects the ions that are heavier than helium. This electrode thus measures the total pressure in the analyzer. This electrode serves as the plate for a triode gauge, hence its name of «triode electrode».

Analyzer cell operating principle

Design and manufacture

Great care has been taken with the design and manufacture of the cell in order to repeatedly obtain the same characteristics and to achieve excellent stability:

- the metal parts are made of stainless steel,
- the filament holder is made of machined aluminium,
- there is an integral amplifier.

The cell assembly is composed of:

- a vacuum chamber or deflection chamber,
- an optic holder flange,
- a permanent magnet,
- an amplifier.

- **The vacuum chamber:**

The analysis cell vacuum chamber is made of light alloy. It is hollow with a rectangular opening into which the electrodes, (that are installed on the «optics holder» flange) are placed.

- **The optics holder flange:**

The optics holder flange supports all the electrodes and electrical connections in the cell. They include:

- the sealed power supply socket, mounted on a metal gasket,
- the amplifier, mounted on an elastomer gasket,
- the supporting block which screens the target and on which the source of ions is mounted,
- the source of ions, which is made up of 2 parts:
 - a filament holder,
 - an ionization chamber with a stainless steel electron collector and a mass ion emitter.

The filament holder mechanically positions the tungsten filament with respect to the ionization chamber.

The electron collector and the filament have been designed and positioned so that the temperature of the electron collector stabilizes at 400°C under bombardment and radiation from the filament. The cell is thus rendered immune to contamination from the pieces being tested without the need of any special heating system.

Testing methods

Overview Leak detection is used to detect micro-openings, porosities, etc. in test parts. The detection of these cracks involves the use of a light tracer gas, which is capable of infiltrating the smallest leak quickly: **Helium**.

The detector samples and measures the helium flow rate entering the test part via the leak(s).

The testing method is selected according to the test part and the measurement accuracy required:

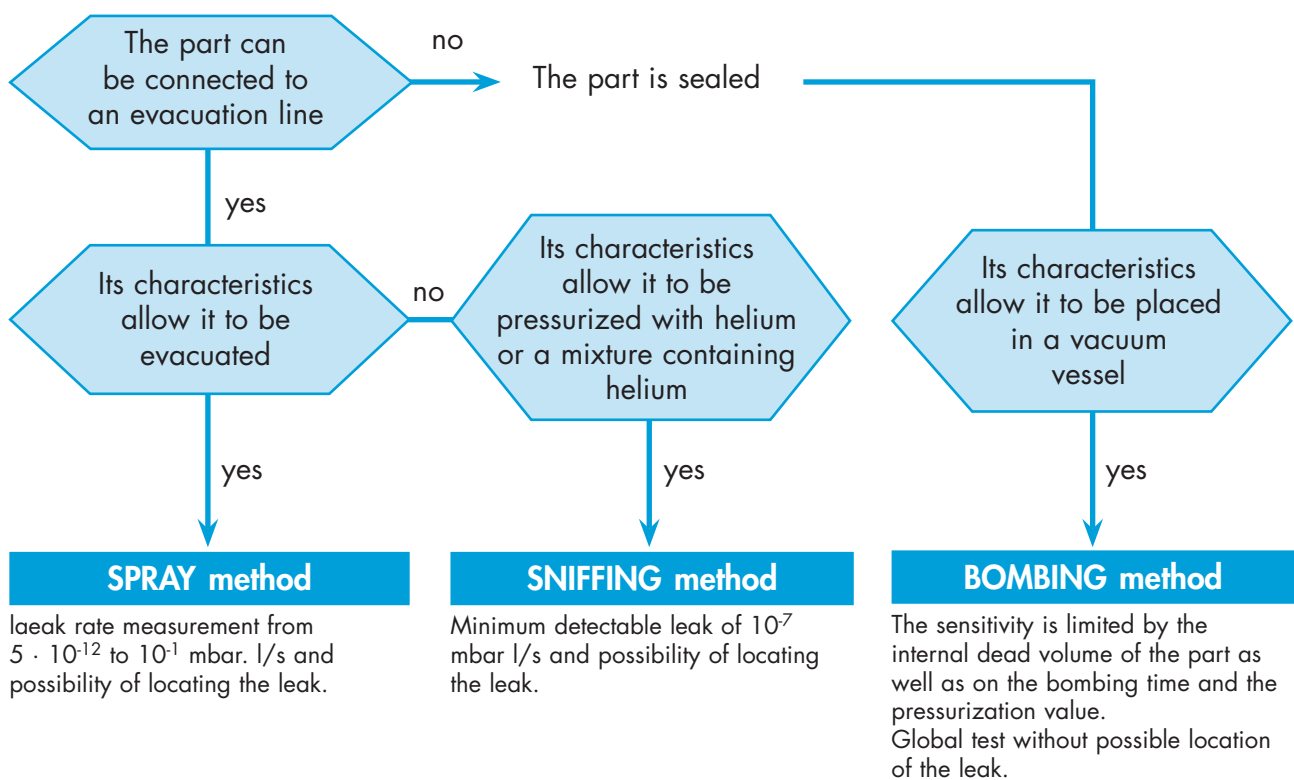

Testing methods

Helium concentration and signal displayed

In accordance to the He concentration rate in the gas used for the leak detection, the signal displayed will change.

Example: signal displayed with a 1×10^{-7} mbar l/s calibrated leak (with 100 % He) connected to the detector inlet.

% He in the gas used	100 %	10 %	1 %
Signal displayed on the leak detector	1×10^{-7} mbar l/s	1×10^{-8} mbar l/s	1×10^{-9} mbar l/s

Spray method (inboard testing)

This involves removing air from the test part, connecting it to the analyzer and then spraying helium over the outer surface.

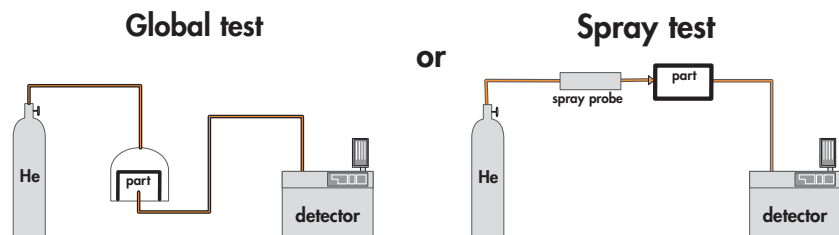

The part is placed under a cover, into which helium is injected.

The leak cannot be located.

The detector measures the flow of helium penetrating the part.

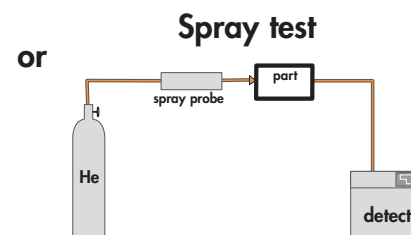

Potential leaking areas are sprayed with helium.

The leak can be located.

Response time

When spraying starts, the leak signal is not displayed instantaneously on the analyzer:

there is a response time which depends on the volume V being tested and the helium pumping speed S of the system at the opening of the part, according to the following relation:

$$T = V/S \quad (T \text{ in seconds, } V \text{ in litres, } S \text{ in l/s})$$

T is the time required for the signal to reach 63 % of the final value.

Testing methods

Sniffer method (outboard testing)

The test part is pressurized with helium. The detector, via an LDS (Long Distance Sniffer) probe, samples the helium escaping from the part.

Global test

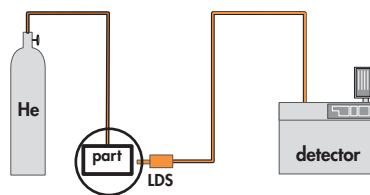

The part is placed under a cover containing a sniffer probe.

The leak cannot be located.

The helium from the leak accumulates over time inside the cover. The detector measures the concentration of helium.

Local sniffing test

or

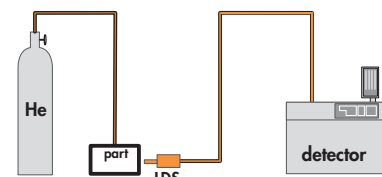

The sniffer probe is moved over areas likely to contain leaks.

The leak can be located.

The signal supplied by the analyzer is not a direct measurement of the leak. The sniffer probe only samples part of the helium escaping from the part. The sample depends on the distance separating the leak from the tip of the probe.

Testing methods

Bombing method

This method is used for sealed objects that cannot be connected directly to the detector (semiconductors, waterproof watches, etc.).

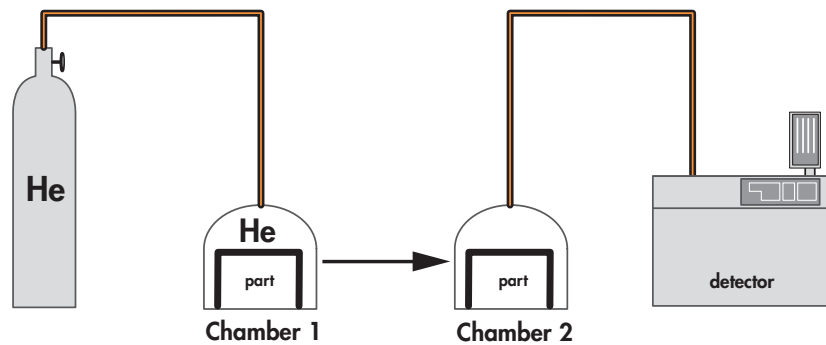

The part is placed in a chamber containing pressurized helium.

The helium penetrates the part if it has a leak.

The part is then removed from the chamber and placed in another vacuum chamber which is connected to the detector. The helium escapes from the part through the leak and produces a signal.

This signal is not a direct measurement of the leak as the helium pressure inside the part is difficult to determine. Several parts play an important part such as: the pressurization time, the helium bombing pressure, the internal volume, the aeration time, the size of the leak.

About Helium and hydrogen

Helium Helium is the second most common element in the universe, representing about 23 % of the total matter. 76 % is Hydrogen. All other elements represent an insignificantly small fraction of the total.

Helium was discovered by spectroscopy in a solar eclipse on August 18, 1868. The discovery in the sun's chromosphere gave the new element its name: "helios" in Greek means "sun". While Helium is very common in the universe most of it is in the stars: on earth it is actually not abundant. Since it is so light all the Helium present during the formation of earth escaped to space. Helium is created, deep in the earth from the radioactive decay of Uranium and Thorium which also generates the earth its internal heat. On earth Helium was discovered in 1881 by spectroscopy of Mount Vesuvio in Italy – the volcanic gases emanated by the mountain showed the same lines in the spectrum as already known from the sun.

Helium concentration in the atmosphere is 5 times bigger than the one of Krypton and 60 times higher than Xenon. Helium comes up with the natural gas and is separated and stored. The annual world wide production is ca. 3×10^7 m³ or 4,500 tons.

Helium is constantly seeping up from the ground all around us, but it is so light that almost all of it escapes into space fairly rapidly. On the other hand there is a constant flow of Helium from space and the sun to earth. This gives a dynamic equilibrium and is the reason for the world wide constant concentration of ca. 5 ppm Helium in air.

Helium is a very light colorless element and it is one of the six noble gases; it is the most difficult gas to liquefy.

Helium is a noble gas, which means it doesn't react with anything for all practical intents and purposes. It's used as an inert shield gas to protect things from oxidation – and of course as leak detection tracer gas.

Helium is a 100 % green gas and has absolutely no environmental impact on the atmosphere.

About Helium and hydrogen

Helium and leak detection: which purity ?

Helium is available in many different purity levels, the highest level of purity is requested from some laboratories for fundamental activities or very accurate analyses.

The use of the Helium as a tracer gas into a mass spectrometer doesn't require such attention. A purity in the range of 97 % to 99 % is enough .

There is absolutely no risk of accuracy lost or contamination for the cell analyzer by using standard purity level of Helium gas.

Hydrogenated nitrogen

If Hydrogen (H_2) and Oxygen (O_2) are mixed and heated, they react and create water vapor (H_2O). During this process more heat is generated which may (if the concentration is high enough) ignite the surrounding gas. If this process propagates, the gas explodes.

At low concentration of Hydrogen (< 4 % in air) the generated heat is not enough to ignite the surrounding gas.

At concentrations in the range 4 to 12 % the combustion may spread only if actions are taken to prevent the generated heat from dissipating. It is a common misconception that hydrogen will explode as soon as the concentration exceeds 4 %. It may explode only if conditions are favorable for spontaneous propagation of combustion.

⚠ DANGER

Never use pure hydrogen or a mixture with a hydrogen concentration higher than 10 % to realize a «hydrogen» test as tracer

If you use the recommended tracer gas of 5 % H_2 / 95 % N_2 and mix it with air there will either be too little hydrogen or too little oxygen to constitute a combustible gas mixture. Hence this gas mixture is classified as non flammable. The actual limit is 5.7 %.

The mixture 10 % H_2 / 90 % N_2 is commonly used in the industry because it is flammable only under certain conditions. This mixture is however classified according to ISO 10156 as Flammable Gas and should only be used after due safety considerations and approvals.

A 500

Operator interface: control panel

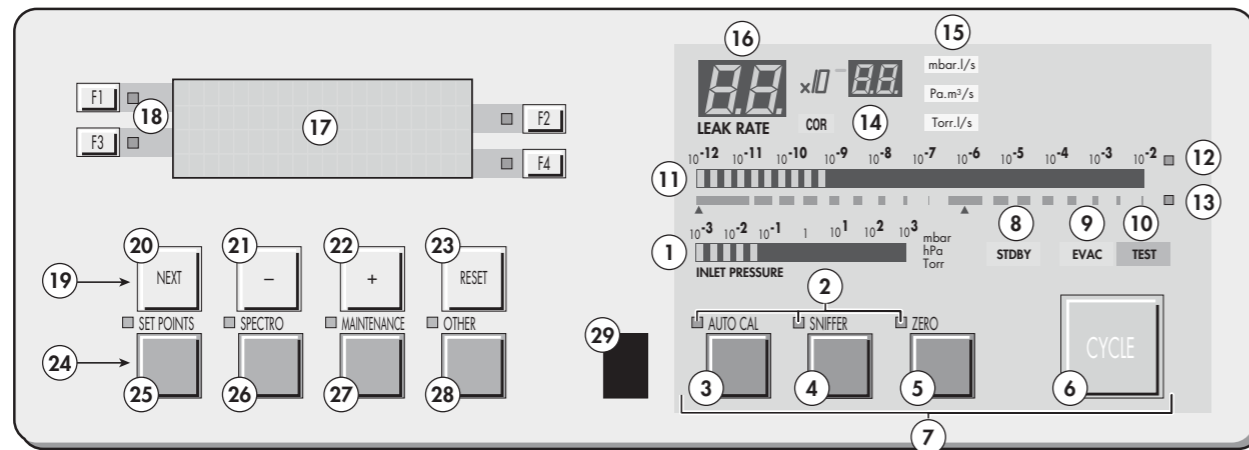

- 1 Inlet port pressure analog display
- 2 Control and menu selection indicators (ON when activated)
- 3 Auto-calibration START/ABORT control key
- 4 Sniffing mode ON/OFF control key
- 5 Auto-zero ON/OFF control key
- 6 Cycle START/STOP control key
- 7 Control keys (4 keys)
- 8 Standby ON/OFF indicator
- 9 Evacuation ON/OFF indicator
- 10 Test ON/OFF indicator
- 11 Helium signal analogic display
- 12 Helium signal analogic scale ON/OFF indicator
- 13 Helium signal Zero scale ON/OFF indicator
- 14 Correction factor COR indicator (applied to digital display)
- 15 Units ON/OFF indicator
- 16 Helium signal digital display
- 17 Alphanumeric display (4 lines x 20 characters)
- 18 Parameter function keys (1 key per display line)
- 19 Modification access keys (4 keys)
- 20 NEXT : next display/parameter circular function
- 21/22 Plus or minus value adjustment, parameter selection, audio volume adjustment keys
- 23 RESET of previously displayed values (cancels temporary inputs)
- 24 Menu selection access keys (4 keys)
- 25 SET POINT menu selection key
- 26 SPECTRO calibration and analyzer cell configuration menu selection key
- 27 MAINTENANCE menu selection key
- 28 OTHER menus selection key (test mode selection, inlet VENT selection, date/time)
- 29 Remote control connection

Operation part

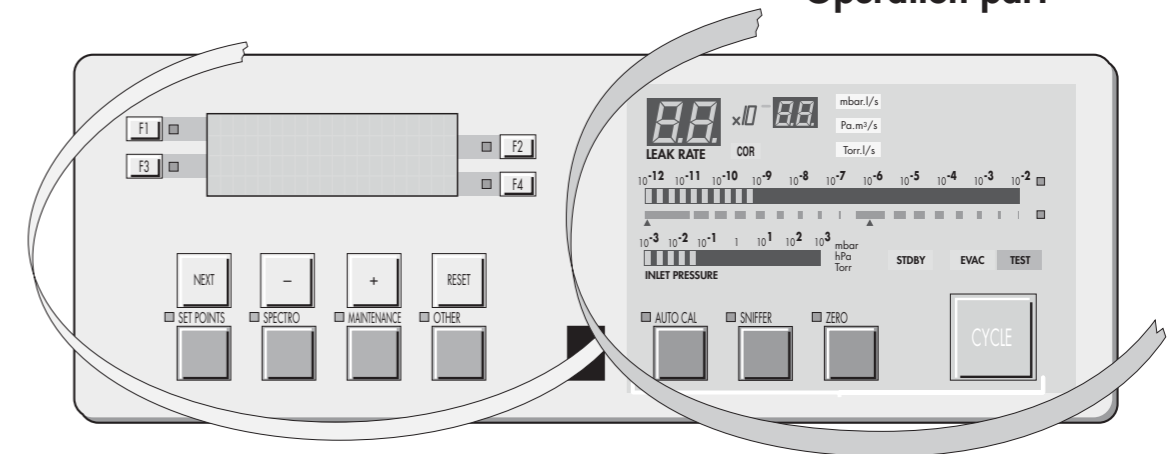

Setting and maintenance part (*)

* Operator access to setting and maintenance part depends on the user interface level.

User interface level C 120

Parameter function keys (1 key per display line)

Helium signal display

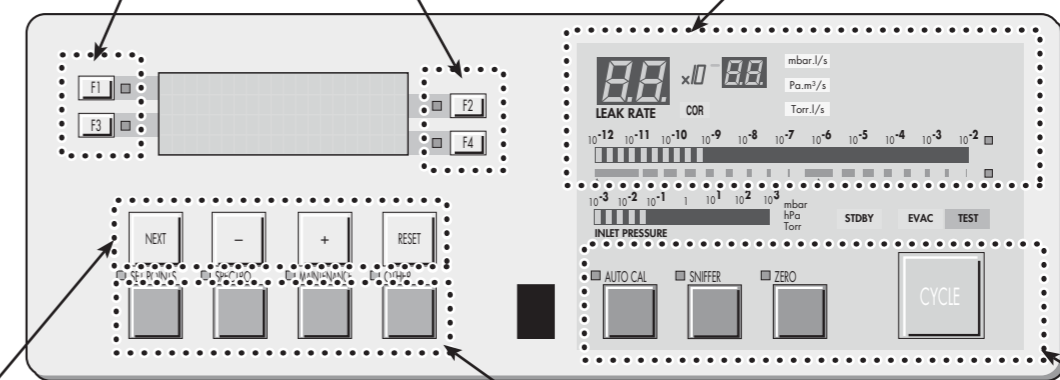

Modification access keys (4 keys)

Menu selection access keys (4 keys)

Control keys (4 keys) and control and menu selection indicators (ON when activated)

Remote control interface C 400

A 500

Operator interface: control panel

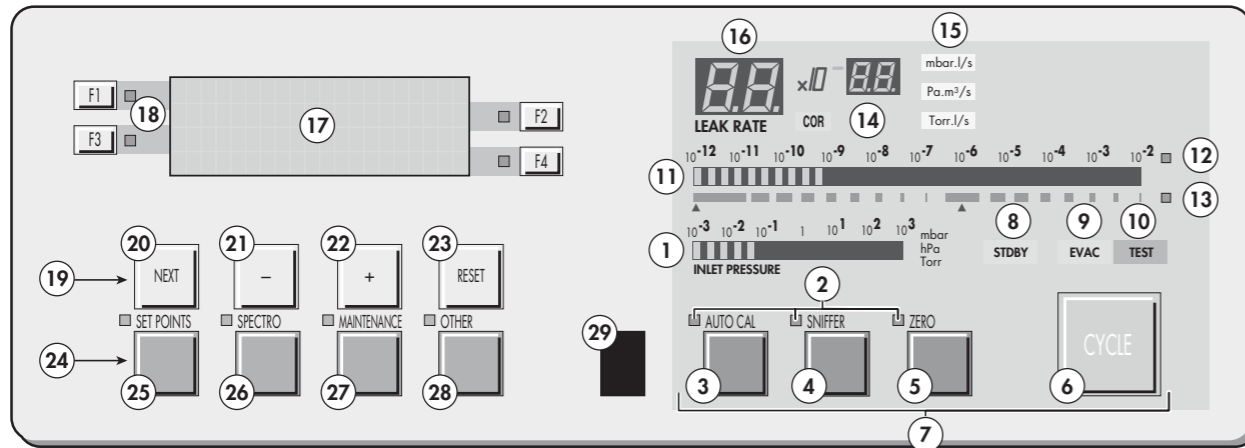

- 1 Inlet port pressure analog display
- 2 Control and menu selection indicators (ON when activated)
- 3 Auto-calibration START/ABORT control key
- 4 Sniffing mode ON/OFF control key
- 5 Auto-zero ON/OFF control key
- 6 Cycle START/STOP control key
- 7 Control keys (4 keys)
- 8 Standby ON/OFF indicator
- 9 Evacuation ON/OFF indicator
- 10 Test ON/OFF indicator
- 11 Helium signal analogic display
- 12 Helium signal analogic scale ON/OFF indicator
- 13 Helium signal Zero scale ON/OFF indicator
- 14 Correction factor COR indicator (applied to digital display)
- 15 Units ON/OFF indicator
- 16 Helium signal digital display
- 17 Alphanumeric display (4 lines x 20 characters)
- 18 Parameter function keys (1 key per display line)
- 19 Modification access keys (4 keys)
- 20 NEXT : next display/parameter circular function
- 21/22 Plus or minus value adjustment, parameter selection, audio volume adjustment keys
- 23 RESET of previously displayed values (cancels temporary inputs)
- 24 Menu selection access keys (4 keys)
- 25 SET POINT menu selection key
- 26 SPECTRO calibration and analyzer cell configuration menu selection key
- 27 MAINTENANCE menu selection key
- 28 OTHER menus selection key (test mode selection, inlet VENT selection, date/time)
- 29 Remote control connection

Operation part

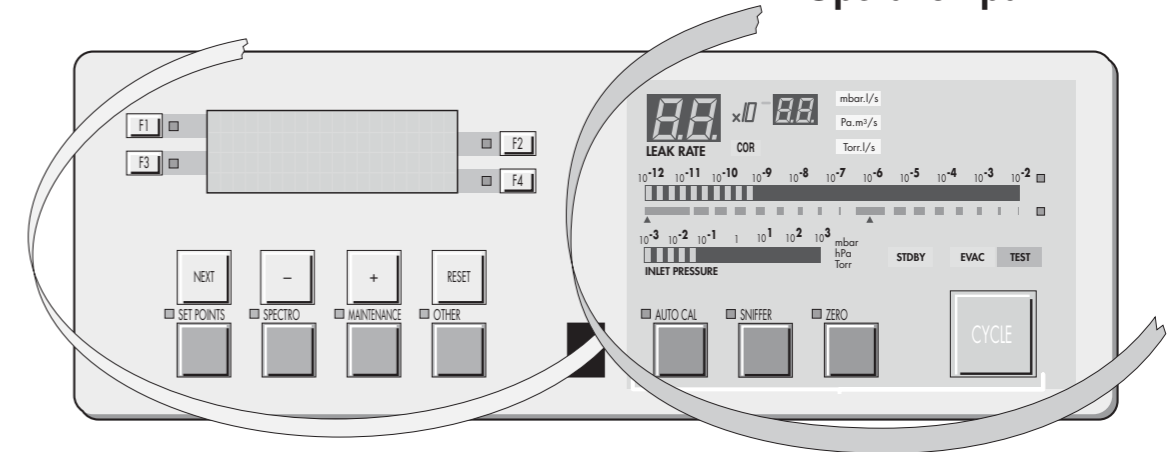

Setting and maintenance part (*)

* Operator access to setting and maintenance part depends on the user interface level.

User interface level C 120

Parameter function keys (1 key per display line)

Helium signal display

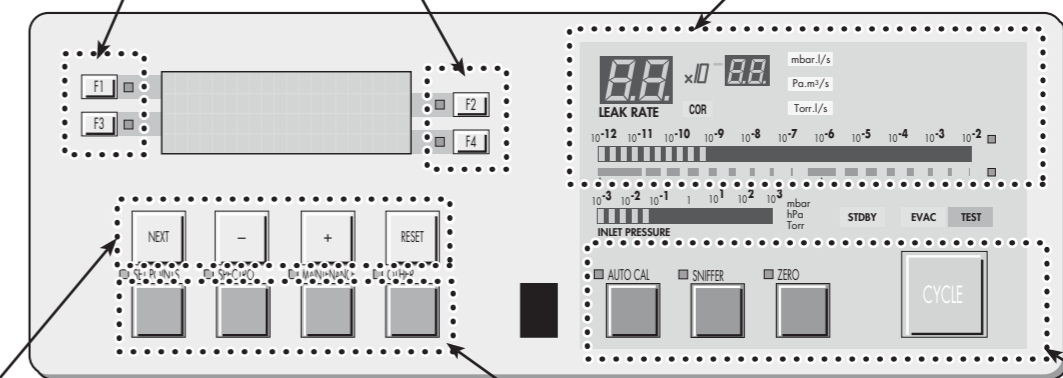

Modification access keys (4 keys)



Menu selection access keys (4 keys)

Control keys (4 keys) and control and menu selection indicators (ON when activated)

Remote control interface C 400

Options

Which options for which model?

		ASM 102 S	ASM 142	ASM 142 S	ASM 142 D	ASM Graph D+	ASM 182 T	ASM 192 T	ASM 192 T2	ASM 182 TD+	ASM 192 TD+	ASM 192 T2D+	ASM 1002
Metal seals	1		•		•	•	•	•	•	•	•	•	•
Inlet port	2												•
Units	3	•	•	•	•	•	•	•	•	•	•	•	•
Languages	4	•	•	•	•	•	•	•	•	•	•	•	•
3 masses	5	•	•		•	•	•	•	•	•	•	•	•
Automatic test chambers	6		•				•	•	•	•	•	•	•
Roughing system	7							•	•		•	•	
Interface board*	8		•	•	•	•							
Remote control cable length	9	•											
Test of gas line	10									•			
Stainless steel cover (UCT)	11									•			
Control panel with graphic interface*	12		•		•	•	•			•			
Transport cart*	 A 700									•			
Voltage configuration	-	•	•	•	•	•	•	•	•	•	•	•	•
Power plug	-	•	•	•	•	•	•	•	•	•	•	•	•
Standard remote control*	 A 700							•	•		•	•	

*also available in accessories

Options

Metal seals

1

Inlet and high vacuum manifolds and the analyzer cell are equipped with metal seals instead of elastomer seals to protect the leak detector against contamination with helium. This option is particularly useful in case of high sensitivity helium leak detection in an "helium contaminated environment".

Localisation of the metal seals  F 800

Inlet port

2

ASM 1002: The test chamber can be replaced by a DN 25 inlet port for convenience.

Units

3

The user can choose the unit of the software: mbar.l/s, Pa.m³/s or Torr.l/s.

Languages

4

The user can choose the language of the software: English, French, German or Japanese.

Note: ASM 142 S: English/French/German/Spanish,
ASM 1002: English/French.

3 masses

5

For use of one of the 3 following tracer gases:
Helium 4, Helium 3 or Hydrogen 2.

Automatic test chambers

6

This is used for the automatic bombing testing of small components. When the chamber cover is closed, the test cycle is initiated, via a contact.

3 aluminium alloy models are available:

- a hemispheric chamber, Ø 72 mm, depth 31 mm (small model),
- a cylindrical chamber, maximum Ø 85 mm and maximum depth 68 mm (medium model),
- a cylindrical chamber, maximum Ø 160 mm and maximum depth 100 mm (large model).

Note: ASM 142: large model not available.

Options

Roughing system

7

In order to reduce the roughing time when testing large volumes, a second roughing pump can be added to the roughing system:

- ASM 192 T / 192 T2 total capacity: 40 m³/h or 24 cfm.
- ASM 192 TD+ / 192 T2D+ total capacity: 50 m³/h or 36 cfm.

Apart from the roughing capacity, the weight and the power consumption, the characteristics and the use of the leak detector remain the same.

Interface board

8

The helium leak detector can be equipped with a software version which will offer a complete RS 232 protocol:

- 3 operating modes: basic, advanced, printer;
- possibility to remote control the detector (start/stop, autozero, auto-cal etc...);
- possibility to obtain and adjust the settings;
- possibility to obtain all the maintenance information for preventive maintenance purposes.

This RS 232 is the most effective interface to supervise your leak test from a PC (data recording on an Excel sheet, for instance) and/or to monitor the detector from a small PLC.

Remote control cable length

9

3 lengths are proposed: 5 m (16 Ft), 10 m (32 Ft) and 15 m (49 Ft).

Test of gas line

10

Used to perform spray testing on long lines (typical diameter 1/4"), with a reduced response time due to the transfer of the helium by a carrier gas injected in viscous flow.

In this case, the detector is equipped with an additional 1/4" VCR connector specific to this option.

Stainless steel cover (UCT)

11

Designed for use of the unit in clean rooms ("Ultra Clean Technology").

The front and rear covers and frame are made of stainless steel.

Options

Control panel with graphic interface

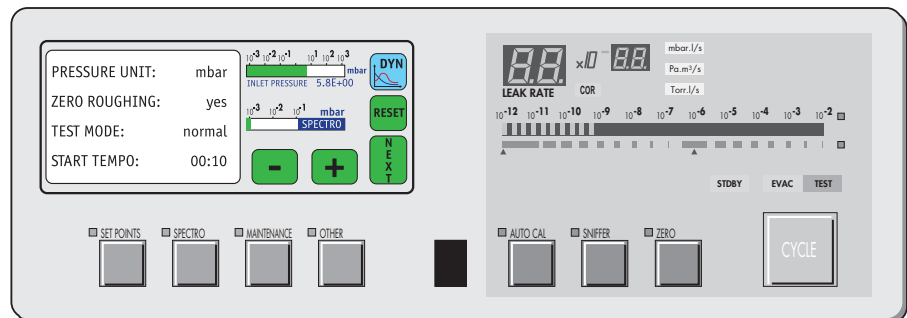

12

The control panel with graphic interface is equipped with a color touch screen. It allows it to have, as a supplement to the standard control panel functions, a graphic interface.



Accessories

Which accessories for which model?

		ASM 102 S	ASM 142	ASM 142 S	ASM 142 D	ASM Graph D+	ASM 182 T	ASM 192 T	ASM 192 T2	ASM 182 TD+	ASM 192 TD+	ASM 192 T2D+	ASM 1002
Standard remote control and cable	1a			•	•	•	•	•	•	•	•	•	•
Sniffing remote control and cable	1b	•		•									
Long distance sniffer (LDS) probe	2	•	•	•	•	•	•	•	•	•	•	•	•
10 m/30 feet LDS extension	3	•	•	•	•	•	•	•	•	•	•	•	•
Headphone connector (required interface board)	4		•	•	•	•	•	•	•	•	•	•	•
Transport cart*	5		•	•	•		•			•			
Foot pedal for cycle command (1.5 m/ 5 feet)	6						•	•	•	•	•	•	•
Calibrated helium leaks	7	•	•		•	•	•	•	•	•	•	•	•
Calibration accessory	8	•	•	•	•	•	•	•	•	•	•	•	•
Spray probe	9	•	•	•	•	•	•	•	•	•	•	•	•
Interface board* (p/n 107657)	 A 600		•	•	•	•							
Inlet filter	10		•		•	•	•	•	•	•	•	•	•
Short distance sniffer probe	11		•		•	•	•	•		•	•		•
Bombing chamber	12		•		•	•	•	•	•	•	•	•	•
Test chambers	13		•		•	•	•	•	•	•	•	•	•
Neutral gas vent line kit	14		•										
Bottle handle for 182 cart	15a									•			
Bottle handle for cart	15b					•							
Control panel with graphic interface* (p/n: 111716)	 A 600		•		•		•			•			

Accessories

Remote control

1

The remote control is equipped with a magnet allowing the operator to place it on a magnetized surface. The operator can read the helium signal and has access to control keys such as cycle command autocalibration and auto-zero.

2 models are available:

1a

■ 1 standard for all leak detectors except ASM 102 S / ASM 142 S:
Remote control with 5 m/15 " cable length:



Designation	Part No
Unit: mbar l/s - Front face in English	106 688
Unit: Torr l/s - Front face in English	108 881
Unit: Pa m ³ /s - Front face in English	108 880
Unit: Pa m ³ /s - Front face in Japanese	106 690

Note: The remote control is delivered in standard with the ASM 192 series.

English serigraphy

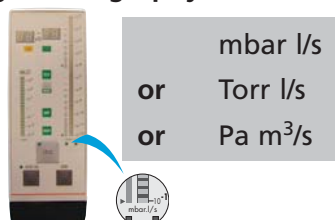

Japanese serigraphy

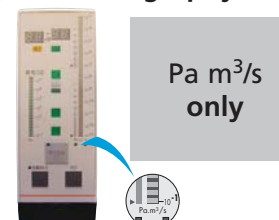

1b

■ 1 specific for sniffing leak detectors (ASM 102 S / ASM 142 S):
Remote control with 5 m/15 " feet cable length:



Designation	Part No
Front face in English. Remote control unit is the unit set in the leak detector menus.	112 747

Cable for remote control (remote control not provided):



Only Cable

Designation	Part No
Cable of 10 m/394"	110 881
Cable of 15 m/591"	110 882
Cable of 20 m/787"	802 494
Cable of 25 m/984"	802 339
Cable of 30 m/1181"	802 767
Cable of 40 m/1575"	802 769
Cable of 50 m/1969"	802 771

Other lengths: on request

Accessories

Long Distance Sniffer probe

2

Sniffer probe with a rigid nipple



Sniffer probe with a flexible nipple



LDS probe part number	5 m/15 Ft canalisation				10 m/32 Ft canalisation			
	Rigid nipple		Flexible nipple*		Rigid nipple		Flexible nipple*	
	9 cm	30 cm	15 cm	45 cm	9 cm	30 cm	15 cm	45 cm
	SNC1E1T1	SNC1E2T1	SNC1E3T1	SNC1E4T1	SNC2E1T1	SNC2E2T1	SNC2E3T1	SNC2E4T1

(*) Sniffer probes with flexible nozzle cannot be used with the ASM 102 S.

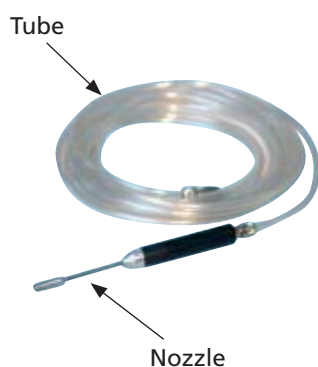

Long distance sniffer with short rigid nozzle (9 cm/3.5"):

Designation	Part No
Tube length 20 m/787"	802 826
Tube length 30 m/1181"	802 827
Tube length 50 m/1969"	802 829

Other lengths: on request

10 m/30 feet LDS extension

3

Used to extend the LDS probe by 10 m/30 feet.
Part No: 090216



Accessories

Headphone connector

4

With the headphone connector, the operator can connect a headphone to its detector.

Part No: **A459818**

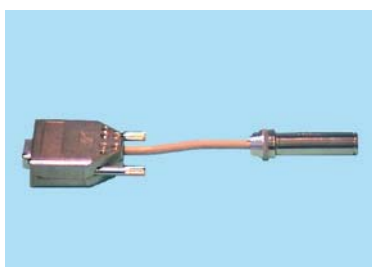

The headphone connector is an accessory but to use it, the detector must be equipped with the interface board option.

Which headphone used?  C 410

Transport cart

5

ASM 182 range

Part No: 111196



Accessories

Transport cart (ctd)

ASM 142 range

It can be fixed to the detector.

Part No: **108068**

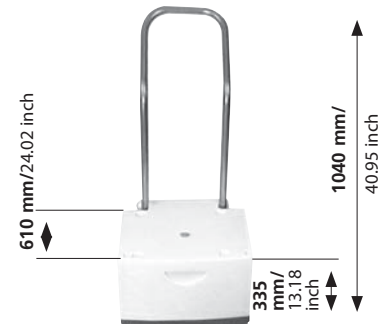

ASM 142 range

In addition to the standard cart (p/n 108068), a 4 wheels stainless steel cart is proposed for 142 series.

Part No: **802862**



Foot pedal for cycle Part No: 100913 command (1.5 m/ 5 feet)

Part No: **100913**

6



Accessories

Calibrated Helium leaks

7

There are several types of calibrated leaks, with or without reservoir, with or without valve, covering several leak ranges. The choice of the appropriate external calibrated leak depends on the application requirements.

For further information on the Pfeiffer Vacuum calibrated leaks, please refer to our representative product catalog or consult your Sales representative.



Most of the Pfeiffer Vacuum calibrated leaks are delivered with a calibration certificate.

Helium 3 and Hydrogen calibrated leaks

The manufacturer does not supply the calibrated leaks in Helium 3 and Hydrogen.

Principle

All Pfeiffer Vacuum calibrated leaks are based on permeable membrane technology.

External calibrated leak recalibration

Most calibrated leaks last many years even though the helium is permanently escaping (the leak rate is very small in comparison to the amount of helium contained in the reservoir: yearly loss is indicated on the calibrated leak identification label).

However, it is recommended to have every calibrated leak (with reservoir) recalibrated on regular intervals to validate its value: this is applicable for both internal and external calibrated leaks.

Recalibration period of the calibrated leak depends on its leak rate value.

Recommendation for proper Quality Control:

THE RECALIBRATION INTERVALS SHOULD NOT EXCEED 2 YEARS.

Please consult your local Sales representative for additional information.

Accessories

Calibration accessory

8

Used to connect the alibrated leak and the sniffer probe for a calibration.

Model	Part No
DN 16	110715
DN 25	110716

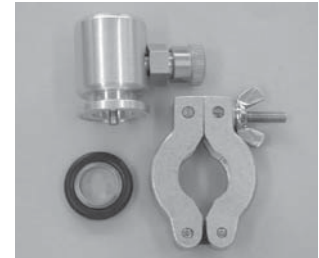

Spray probes

9

9a

Helium spray probe model "Elite".
Part No: 109951

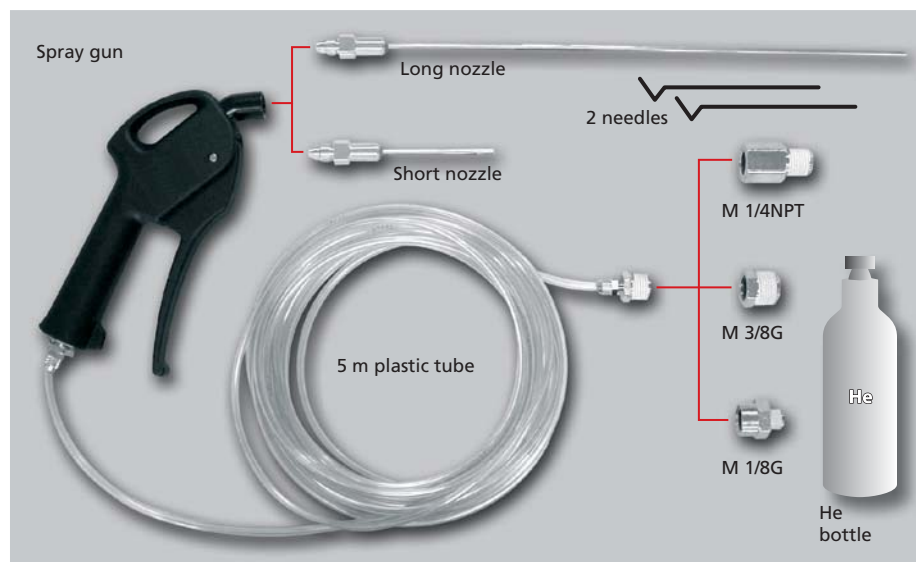

Spraying Helium in order to detect a leak is usually very easy, especially if you need fast and rough detection.

Spraying Helium could also become a technical challenge when you need to pinpoint very fine leaks, more so, when they are located in areas with difficult access.

The Helium spray gun is provided with 2 standard needles wich allow the adjustment of the Helium flow at the outlet of the nozzle.

Accessories

- 9b** Helium spray probe model "standard".
Part No: **112535**

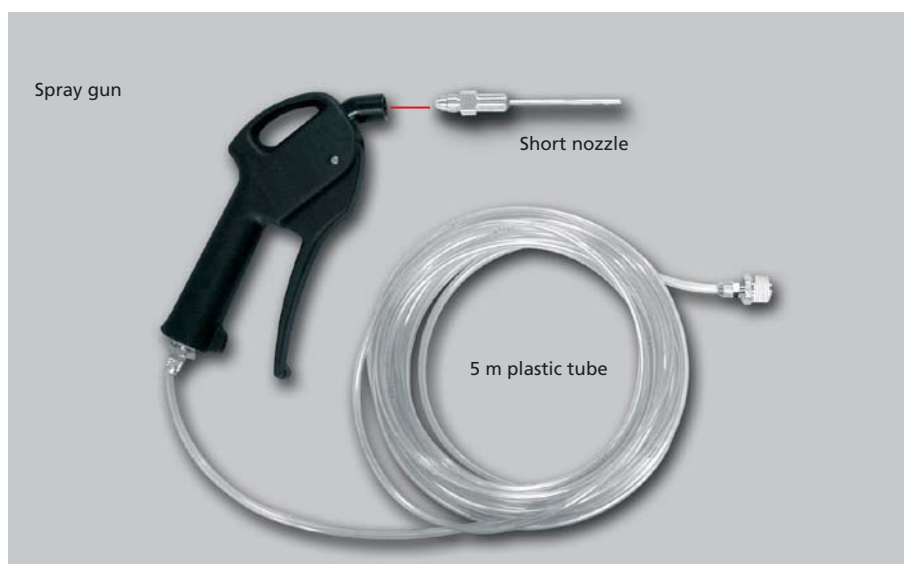

Spraying Helium in order to detect a leak is usually very easy, especially if you need fast and rough detection.

Spraying Helium could also become a technical challenge when you need to pinpoint very fine leaks, more so, when they are located in areas with difficult access.

Inlet filters

10



Complete inlet filters



Model	DN Flange	Part No
20 µm inlet filter	25/25	105841
20 µm inlet filter	40/40	105842
20 µm inlet filter	40/25	105843
5 µm inlet filter	25/25	105844
5 µm inlet filter	40/40	105845
5 µm inlet filter	40/25	105846

Accessories

Spare parts for inlet filters

	Model	DN Flange	Part No
	Stainless steel filter 70 µm	16	072721
	Stainless steel filter 70 µm	25	072857
	Stainless steel filter 70 µm	40	067636
	20 µm inlet filter	Ø 114 mm	105847
	5 µm inlet filter	Ø 114 mm	105848
	O'ring, dia. 5 mm	Ø 114 mm	082152

Short distance sniffer probe (to be connected to the inlet part of a leak detector):

Temperature coefficient: 7 % per °Celsius.

Standard leak rate: 2×10^{-4} mbar l/s

Able to measure helium concentration inside water or liquids.

11



Designation	DN Flange	Part No
Sniffer probe with membrane, DN 40 flange and a 1.5 meter tube (5 ft)	40	067 683
Sniffer probe with membrane, DN 40 flange	40	067 677
Sniffer probe with membrane, DN 25 flange	25	103 592
Sniffer probe with membrane and 14 mm O.D. smooth tube connection	Ø 14 mm	067 678

Accessories

Bombing chamber

12

Designation	DN Flange	Part No
Bombing chamber 10 bars (Ø 150 - L 200 - Vol.: 3.5 l)	-	786 396
Bombing chamber 25 bars (Ø 150 - L 200 - Vol.: 6.4 l)	-	786 397

Test chambers

13

- Small test chamber: hemispherical test chamber, Ø 72 mm, depth 31 mm
- Medium test chamber: cylindrical test chamber, Ø 85 mm, depth 68 mm
- Large test chamber: cylindrical test chamber, Ø 160 mm, depth 100 mm



Designation	Part No
Small test chamber DN 25 (1)	802 452
Small test chamber DN 40 (2)	802 453
Medium test chamber DN 40 (2)	802 456
Large test chamber DN 40 for ASM 182 T/TD+	802 458

- (1) ASM 142 - ASM 142 D
 (2) ASM 182 T/TD+ - ASM 192 T/TD+

Accessories

Neutral gas vent line kit

Part No: 801421

14



Neutral gas vent line kit

Bottle handle for cart

15

15a

ASM 182



Bottle handle for cart p/n 111196

Part No: **802819**

Bottle maxi weight: 15 kg/33 lbs

Accessories

15b ASM Graph D+



Part No: 112 532 (Ø 135-146)
112 533 (Ø 177)

ASM 182 / 192 T Technical characteristics

	Measurement range* (Helium)		Crossover pressure (at inlet)	
	mbar l/s	Pa m ³ /s	mbar	Pa
Gross leak test mode	1 · 10 ⁻⁸ to 1 · 10 ⁻¹	10 ⁻⁹ to 10 ⁻²	6	600
High sensitivity test mode	1 · 10 ⁻¹¹ to 3 · 10 ⁻⁴ 5 · 10 ⁻¹² function with zero	1 · 10 ⁻¹² to 3 · 10 ⁻⁵ 5 · 10 ⁻¹³ function with zero	2 · 10 ⁻²	2
Sniffing test mode	1 · 10 ⁻⁷ to 1 · 10 ⁻¹	1 · 10 ⁻⁸ to 1 · 10 ⁻²	sniffer probe at atm. pressure	
Response time (Inlet port blanked off)			< 0.5 s	

* Zero function not activated, in standard conditions (20 °C, 5 ppm He ambient, degassed detector).

Helium pumping speed:

At inlet port	4.4 l/s
---------------	---------

Technical data according to AVS 2.3 or EN 1518 or ISO 3530 standard.

Roughing (primary) pump characteristics:

Primary pump pumping speed (in air) (ASM 182 T)	20 m ³ /h
Primary pump pumping speed (in air) (ASM 192 T standard)	25 m ³ /h
Primary pump pumping speed (in air) (ASM 192 T + roughing option)	50 m ³ /h

Hybrid turbomolecular pump characteristics:

Hybrid turbomolecular pump pumping speed (in air)	110 l/s
Hybrid turbomolecular pump exhaust pressure safety limit	6 mbar

Analyzer cell (Spectro):

Analyzer cell design	self protected 180° magnetic deviation mass spectrometer
Analyzer cell filament	2 tungsten filaments
Analyzer cell sensitivity	3 · 10 ⁻⁴ A/mbar
Emission current range	0,2 to 2 mA
Air pumping speed	110 l/s
Helium pumping speed	30 l/s

ASM 182 / 192 T Technical characteristics

Displays and setpoints adjustments:

Inlet port pressure display range	10^3 to 10^{-3} mbar / 10^5 to 10^{-1} Pa
-----------------------------------	---------------------------------------------------

Audio alarm:

90 dB modulated and adjustable audio signal

Hard vacuum Audio signal set point	Adjustable throughout the entire measuring range
Sniffing Audio set point	Adjustable throughout the entire measuring range

Start-up time (at 20° C)

Without auto-calibration	3 min 10 s ± 10 %
With auto-calibration	4 min 30 s ± 10 %

Time to reach test mode (Hard vacuum test):

	inlet port blanked-off	connected to 1.6 l volume	connected to 46 l volume	connected to 200 l volume
ASM 182 T				
Gross leak test mode	3 s	< 6 s	< 1 min 20 s	< 5 min
High sensitivity test mode	4 s	< 25 s	< 3 min 20 s	< 15 min

ASM 192 T

Gross leak test mode	3 s	< 6 s	< 50 s	< 3 min 10 s
High sensitivity test mode	4 s	< 25 s	< 2 min 50 s	< 13 min 40 s

ASM 182 / 192 T Technical characteristics

Miscellaneous:

Power voltage	low voltage:	100 - 130 V \pm 10%	
	high voltage:	200 - 240 V \pm 10%	
Power frequency	50/60 Hz single phase		
Power consumption (maximum) (ASM 182 T)	1 kVA		
Power consumption (ASM 192 T) Maximum at roughing (delay 1 s): Stabilized at roughing (max.): Stabilized in test mode or in stand by mode:	1 RVP	2 RVP	
	1.5 kVA	2.4 kVA	
	1.3 kVA	2.2 kVA	
	0.6 KVA	0.7 kVA	
Start-up temperature	10 to 40° C		
Ambient operating temperature	10 to 40° C		
Storage temperature (standard detector)	-25° C to 70° C		
Storage temperature (ASM 182 T equipped with the graphic interface control panel)	-20° C to 60° C		
	max. 48 h at -20° C max. 168 h at 60° C		
Humidity (ASM 182 T equipped with the graphic interface control panel)	Ta \leq 40° C	Ta > 40° C	
	85 % relative humidity max.	Absolute humidity must be lower than the humidity of 85 % relative humidity at 40° C (43.4 g/m ³ in the air)	
Noise level (at 1 meter; audio alarm not operational, stand by mode)	54 dBA		
House protection level	IP 30C		
Inlet	DN 40		
Hygrometry max. (at 40° C)	95 %		
Weight	ASM 182 T:	76 kg/167 lb	
	Standard ASM 192 T:	150 kg/330 lb	
	ASM 192 T + roughing option:	180 kg/396 lb	
Part to be tested weight max.	30 kg/66 lb		

ASM 192 T2 Technical characteristics

	Measurement range* (Helium)		Crossover pressure (at inlet)	
	mbar l/s	Pa m ³ /s	mbar	Pa
Gross leak test mode	$6 \cdot 10^{-10}$ to $3 \cdot 10^{-2}$	$6 \cdot 10^{-11}$ to $3 \cdot 10^{-3}$	6	600
High sensitivity test mode	$1 \cdot 10^{-11}$ to $3 \cdot 10^{-4}$ 5 · 10 ⁻¹² function with zero	$1 \cdot 10^{-12}$ to $3 \cdot 10^{-5}$ 5 · 10 ⁻¹³ function with zero	$2 \cdot 10^{-2}$	2
Sniffing test mode	$1 \cdot 10^{-7}$ to $1 \cdot 10^{-1}$	$1 \cdot 10^{-8}$ to $1 \cdot 10^{-2}$	sniffer probe at atm. pressure	
Response time (Inlet port blanked off)			< 0.5 s	

* Zero function not activated, in standard conditions (20 °C, 5 ppm He ambient, degassed detector).

Helium pumping speed:

At inlet port	20 l/s
---------------	--------

Technical data according to AVS 2.3 or EN 1518 or ISO 3530 standard.

Roughing (primary) pump characteristics:

Primary pump pumping speed (in air)	50 m ³ /h
-------------------------------------	----------------------

Analyzer cell (Spectro):

Analyzer cell design	self protected 180° magnetic deviation mass spectrometer
Analyzer cell filament	2 tungsten filaments
Analyzer cell sensitivity	$3 \cdot 10^{-4}$ A/mbar
Emission current range	0.2 to 2 mA
Air pumping speed	110 l/s
Helium pumping speed	30 l/s

Displays and setpoints adjustments:

Inlet port pressure display range	10^3 to 10^{-3} mbar / 10^5 to 10^{-1} Pa
-----------------------------------	---------------------------------------------------

Audio alarm:

90 dB modulated and adjustable audio signal

Hard vacuum Audio signal set point	Adjustable throughout the entire measuring range
Sniffing Audio set point	Adjustable throughout the entire measuring range

Dimensions (inch) ASM 182 T

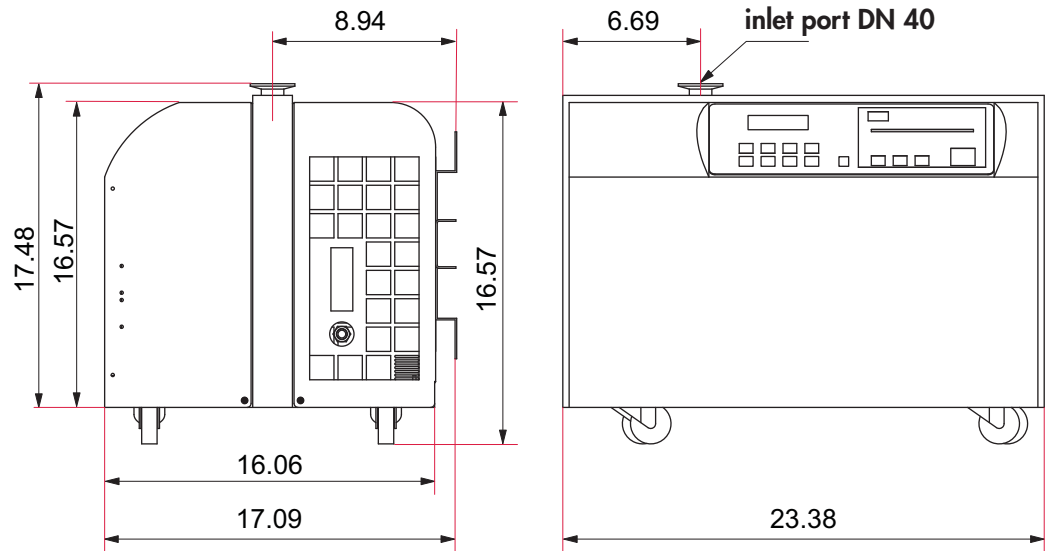

Dimensions (inch) The ASM 192 series

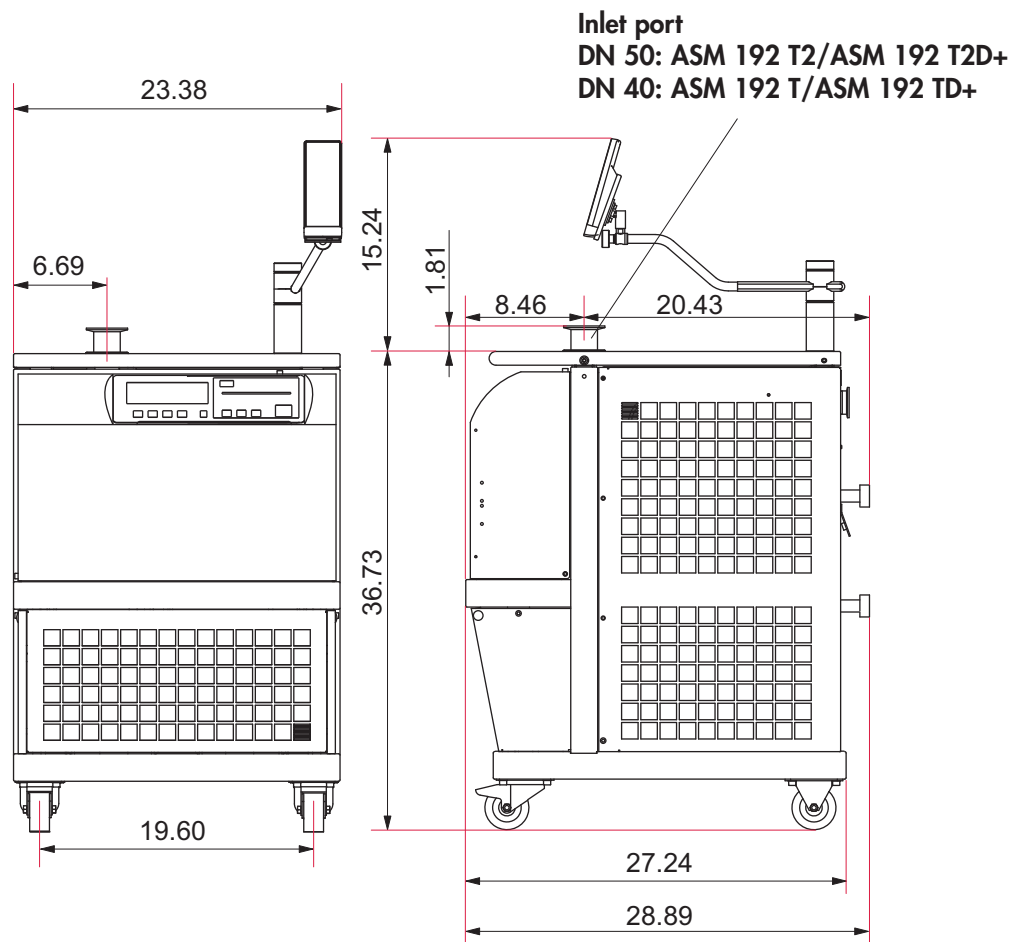



Installation

ASM 182 T - ASM 192 T - ASM 192 T2 Operating instructions Detailed contents

Preliminary remarks Throughout this operating manual, you could find this type of message “Summary of screen  C 140”: it refers to a specific chapter of the operating manual. Please read it for further information.

B 100 *Safety instructions*

- Overview
- Storage
- Unpacking
- Installation
- Operation
- Maintenance

B 110 *Unpacking - Storage - Transportation*

- Unpacking
- Handling the leak detector with a hoist and slings
- Precautionary measures for the leak detector installation
- Storage
- Transport

B 112 *Product labelling*

- Detector packaging
- Detector
- Pumps

B 200 *Neutral gas purge and inlet vent connection*

- Products concerned
- Connection to the leak detector
- Use
- Gas characteristics

B 210 *ASM 182 - Connecting the detector to the installation*

B 211 *ASM 192 - Connecting the detector to the installation*

B 300 *Controlling the detector with the I/O interface*

- Purpose of the I/O interface
- Location of the I/O interface
- Prepare the connector wiring
- The controls (inputs)
- The signals (outputs)
- 24 V DC Power supply



Installation

ASM 182 T - ASM 192 T - ASM 192 T2 Operating instructions Detailed contents

B 310 *Controlling the detector with a PC computer through the RS 232 interface*

- Purpose of the PC computer interface
- Location of the RS 232 interface
- RS 232 interface instructions
- Commands available for your leak detector
- RS 232 interface setting
- Connection checking of RS 232 interface

B 320 *Connecting the detector directly to a printer or another device*

- Purpose of the printer interface
- Location of the printer interface
- Connector description
- Communication mode description
- Connection to the printer
- Tickets available

B 400 *ASM 182 series - Before starting up the leak detector*

- Check power voltage
- Installation
- Check the oil level of the roughing pump (ASM 182 T)

B 401 *ASM 192 series - Before starting up the leak detector*

- Check power voltage
- Check the oil level of the roughing pump (ASM 192 T/T2)
- Installation
- Remote control support installation

Safety instructions

CAUTION

Indicates a potentially hazardous situation which, if not avoided, could result in property damage.

CAUTION

Indicates a potentially hazardous situation which, if not avoided, could result in moderate or minor injury. It may also be used to alert against unsafe practices.

WARNING

Indicates a potentially hazardous situation which, if not avoided, could result in death or severe injury.

DANGER

Indicates an imminently hazardous situation that, if not avoided, will result in death or severe injury (extreme situations).

Overview

Before switching on the appliance, study the user's manual and make sure you follow the safety instructions it gives. You can recognise these by the 'Caution', 'Warning' and 'Danger' symbols.

Good practice tips and manufacturer's recommendations are in a blue box.

The performance and operational safety of this product are guaranteed provided it is used normally in the operating conditions defined in this manual.

It is the customer's task to:

- train operators to use the product if they do not speak the language the manual is written in,
- ensure operators know the safe practices to apply when using the product.

We took care to provide you with a clean appliance. To keep it in this condition, unpack it only in its final place of use.

For emergencies and breakdowns, contact the manager of your local service center (see addresses at back of manual).

Make sure the equipment shows no sign of transport damage. If it has been damaged, take the necessary steps to record this with the carrier and inform the manufacturer. In all cases, we recommend keeping the packaging (reusable materials) for further transport of the equipment or for prolonged storage.

Safety instructions

Our products are designed to comply with current EEC regulations. Users making their own modifications to the product are liable to break its compliance with these regulations, degrade its EMC (electromagnetic compatibility) rating, and make it unsafe to use. The manufacturer declines all liability for the consequences of such operations.

CAUTION

The product's EMC rating is obtained on the understanding that it is installed in compliance with EMC rules.

Of special note: in environments that are prone to emit interference,

- use shielded cables and connections on interfaces,
- put earthed screening on the power supply line, from the power source up to 3 meters (10 ft) from the product cable entry.

Storage

When storing the detector, please note that we guarantee the reliability of our equipment for three months in normal storage conditions (see operating manual for storage temperatures). Beyond this period, factors like temperature, humidity, or salt in the air can lead to deterioration of 'sensitive' items (elastomer, lubricant, etc.).

For storage longer than 3 months, follow the instructions in this operating manual.

Unpacking

Heavy detector

This product needs special handling precautions due to its weight. It should be removed from its crate only by staff trained in heavy materials handling:

- make sure the detector is stripped of all excess weight (accessories, customization, etc.) and the side covers are fastened,
- use the lifting rings provided with the product. The maker can not be held liable for the consequences of using other rings.
- screw the rings firmly home into the holes, provided, facing in the right direction to accept the slings,
- never lift the detector by means of a single lifting ring,
- the sling must not form an angle of more than 45 ° from vertical.

Installation

WARNING

Risk of tilting.

Although the appliance meets EEC safety regulations (normal range $\pm 10^\circ$), it is advisable to guard against the risk of tilting during handling, installation, and use.

ASM 380 detector.

When the detector is placed on a gradient of more than 3 ° (6 %), it can drag the operator along due to its heavy weight:

- use castors to move it,
- locate it on flat, hard ground,
- do not push it sideways or press on its side faces,
- do not leave objects leaning on the side of it.

The detector is not designed to carry people or loads and is not for use as a seat or step.

Safety instructions

Installation (cont.)

In leak detectors fitted with atmospheric air purging, avoid performing detection operations in non ventilated rooms. The helium concentration may be too high.

CAUTION

The leak detector must be installed on a horizontal flat surface and never laid on its side. Some models cater for other positions; these are described in the operating manual.

CAUTION

The leak detector is Class 1 equipment and therefore must be earthed. The user must check the electrical installation to which the leak detector is connected:

- it must comply with current standards (IEC 364),
- it must have a standards compliant earth wire, properly connected to earth.

WARNING

Electric shock hazard on touching.
When the main isolator is switched to the «0» position, items located between the mains connection and the isolator are still under mains voltage. Disconnect the mains cable from all power sources before commencing any maintenance work on the product.

WARNING

Electric shock hazard.
Some components have capacitors charged to over 60VDC. When power is switched off, they keep their charge for a time. Residual voltages from the filter capacitors can cause electric shocks all the way back to the mains plug. Wait 5 minutes after power-off before commencing any work on the appliance.

WARNING

A helium leak test must be performed in environmental conditions bearing no risk to the user or equipment.
The user and/or OEM are ultimately responsible for ensuring proper safety conditions apply to the working product. The manufacturer has no control over the type of gas the detector is used with. Parts tested, equipment used and the plan itself must show no traces of aggressive, chemical, corrosive, inflammable, reactive, toxic, explosive substances, in an form whatsoever (solid, liquid, gaseous).
Note: any pumping of liquid water is forbidden; water steam contained naturally in the air can be pumped (see maxi concentration indicated in the environmental conditions of the operating instructions: see **A 100**
These are hazardous substances, and the process user must take responsibility for applying all relevant safety instructions in accordance with the legislation in effect at the site.
The detector's nitrogen purge system is not intended to dilute these gases. The manufacturer can not be held liable and the guarantee is void if the detector is used while these gases are present.

Safety instructions

Installation (cont.)

WARNING

Lock out (LO/TO) of nitrogen purging circuit.
The user will need to provide a dedicated Nitrogen circuit, fitted with a manual valve, that can be locked out within a radius of 3 m (10 ft) of the equipment.

Operation

CAUTION

ASM 380 detector
This leak detector must not be used without its purge system. The user must make sure the purger is present and working properly.
The manufacturer shall not be held liable for any damage to the product and the guarantee is void if the purge does not work.

WARNING

The products are factory tested to ensure they will not leak in normal operating conditions. It is the user's responsibility to ensure this level of leak tightness is maintained.

DANGER

Explosion hazard.
To detect leaks using «hydrogen» tracer gas, always use hydrogenated nitrogen (95 % N₂ and 5 % H₂) (see chapter A of operating manual).

CAUTION

If the appliance is used in applications where dust or solid particles are present, we advise protecting it with an inlet filter (see section A of the operating manual).
Always use clean pipes and fittings in the pumping installation.

CAUTION

Make sure all parts and chambers connected to the inlet of our products can withstand a negative pressure of 1 bar below atmospheric pressure and that they are impervious to damage from vacuum (seals, etc.).

CAUTION

The inlet pressure must be no higher than atmospheric pressure. Too high a pressure can damage the product

WARNING

Remove the blanking plates on the inlet and exhaust orifices. These are to prevent foreign bodies entering the pump during transport and storage.

Safety instructions

Operation (cont.)

CAUTION

Make sure the exhaust pressure does not exceed 1200 mbar (absolute). Too high a pressure can damage the appliance.

After connecting the appliance to the pumping line, check for leaks along the whole of the line to ensure proper connections have been made (pump, pipes, valves, etc.).

CAUTION

Leak detectors fitted with oil seal roughing pumps. These pumps come without oil, which is delivered in separate drums. The material safety sheet for the oil is available upon request. Always wear gloves and goggles when filling the pumps with oil.

DANGER

The voltages and currents in use can induce electric shock. Isolate and lock out power to the appliance before maintaining it or removing the cover. Only skilled, authorized people may carry out maintenance work.

CAUTION

Risk of seizing
Avoid moving or applying shock to a running detector.
Portable detectors: avoid rotating the appliance about an axis perpendicular to the axis of rotation of the high vacuum pump.

CAUTION

ASM 380 detector.
Nipping hazard:
- keep hands away from the sides when opening the cover,
- keep hands away from the front of the cover when closing it.
Laceration hazard:
Do not move the appliance by holding the bumper bar. Use the handle provided.

Maintenance

The outside of the appliance and control box can be cleaned with a lint free wiper. Avoid using cleaning products that deteriorate printed surfaces and self adhesive labels. All other cleaning operations must be done by our service centers.

Safety instructions

Maintenance (cont.)

Do not eliminate maintenance waste via standard disposal channels. Have it destroyed by a qualified company if necessary: see  F 003.

CAUTION

Leak detectors fitted with oil seal roughing pumps.
We advise draining the pump prior to any transport of the equipment.
Always wear gloves and goggles when draining the pumps.
Do not put waste oil down the drain. Have it destroyed by a qualified company if necessary.

WARNING

Maintenance must be performed by a skilled maintenance operator trained in the relevant health and safety aspects (EMC, electrical hazards, chemical pollution, etc.).
Isolate the product from all energy sources (mains electricity, compressed air, etc.) before starting work.
Major overhauls must be performed by qualified staff who have received training from the manufacturer, especially when it comes to handling the fluids inside the detector (see instructions in operating manual).

WARNING

The products are designed to avoid subjecting users to heat hazards. Specific operating conditions can nevertheless exist that require extra caution from users due to the high temperatures generated (outer surfaces > 70° C):
Wear protective gloves to work on the appliance, especially during maintenance.

Unpacking - Storage - Transportation

Unpacking

When the equipment is received, unpack it carefully. Keep the packaging for possible return. The following are supplied with your unit: (if one of these parts is missing, contact the manufacturer immediately).

	ASM 182 T	ASM 192 T	ASM 192 T2	ASM 182 TD+	ASM 192 TD+	ASM 192 T2D+
a calibration certificate of the internal calibrated leak	●	●	●	●	●	●
an operating manual	●	●	●	●	●	●
a RS 232 operating manual	●	●	●	●	●	●
a maintenance kit	●	●	●	●	●	●
a funnel	●	●	●	●	●	●
an A200 oil can	●	(1)	(1)	●	●	●
a RMI socket connector	●	●	●	●	●	●
a connector plug	●	●	●	●	●	●
a connector	●	●	●	●	●	●
2 plastic stoppers	●	●	●	●	●	●
a remote control	●	●	●	●	●	●
a remote control support	●	●	●	●	●	●
a bracket for remote control	●	●	●	●	●	●
a bag with 3 electrical power plugs	●	(2)	(2)	●	(2)	(2)



(1) Qty: 2 oil can for ASM 192 T with roughing option and ASM 192 T2
 (2) Only for equipment in high voltage and US grip

Check the packaging **tilt indicator** of the detector. Before opening, check the **name of the model** and the **serial number**.

In the event of an anomaly, take the necessary action with the shipper and notify the manufacturer if necessary.



Déballage - Stockage - Transport

Handling the leak detector with a hoist and slings



Compact version

Two lifting rings are supplied with the leak detector. Plugs are also supplied to replace the rings during normal use of leak detector.

Note: If the operator doesn't use a hoist, 2 people are necessary to carry the leak detector.

Weight:  A 800



Console version

Four lifting rings are supplied with the leak detector. They will be screw at the back of leak detector after unpacking.

Weight:  A 800 / A 801

■ In the event of any damage, contact the manufacturer.

Unpacking - Storage - Transportation

Precautionary measures for the leak detector installation

The leak detector is equipped with 4 pivoting wheels without brake, (2 wheels with brake on the console version). So:

If the detector is placed on a high surface, the operator should take care to lock the wheels of the detector.

It's forbidden to place the leak detector on a sloping surface (> 1 %) without take precautions for its translation stop.

Storage

For prolonged storage, factors such as temperature, humidity, saline atmosphere, etc. may damage the detector elements.

Please call your local representative for further information.

Before starting up after storage for over six months, it is recommended to change all the seals (contact customer service).

The seals kits must be kept away from heat and light (direct sunlight and ultraviolet light) in order to prevent hardening of the elastomers.

Transport

We advise for any transport to use the original packaging and to wedge the detector carefully into the box.

Product labelling

Detector packaging

- Marking on the packaging used for product delivery.

WARNING

WE RECOMMEND KEEPING THE ORIGINAL PACKAGING (REUSABLE MATERIALS) FOR FURTHER TRANSPORT OF THE EQUIPMENT.

CONSULT THE OPERATING INSTRUCTIONS BEFORE PRODUCT UNPACKING.

ATTENTION

NOUS VOUS RECOMMANDONS DE CONSERVER L'EMBALLAGE D'ORIGINE (MATERIAU RECYCLABLE) POUR TRANSPORTER L'EQUIPEMENT.

CONSULTER DE L'UTILISATEUR AVANT DEBALLAGE DU PRODUIT.

ACHTUNG

WIR RATEN IHNEN DIE ORIGINALVERPACKUNG (WIEDERVERWERTBARES MATERIAL) FÜR EINEN SPÄTEREN TRANSPORT AUFZUBEWAHREN.

VOR DEM AUSPACKEN, DER BETRIEBSANLEITUNG LESEN UND BEACHTEN.

- Shock indicator: indicates if the box has been shook.

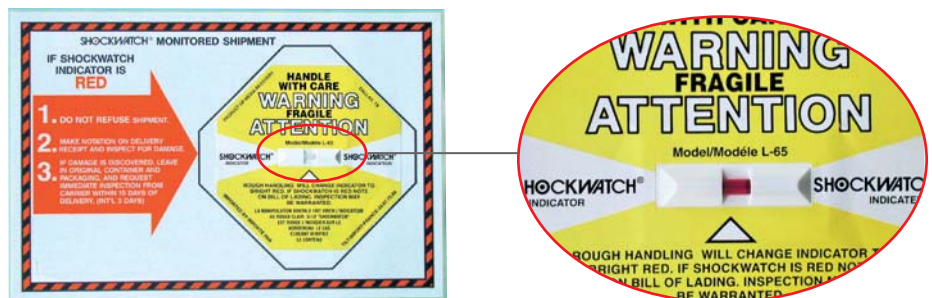

- Tilt indicator: indicates that the box has been tipped.

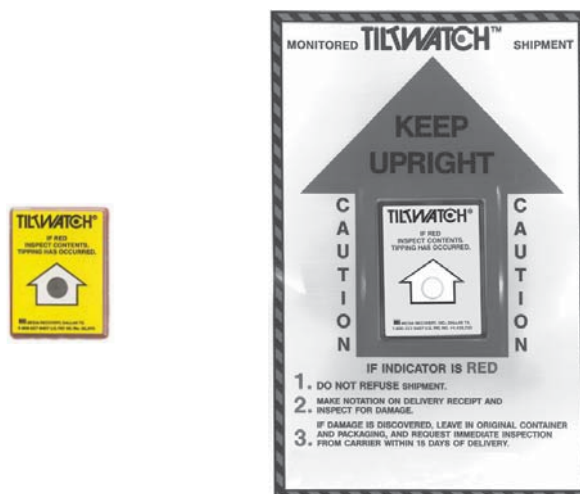

- Safety label: guarantees that nobody has opened the packaging since the manufacturing departure.



Product labelling

- Detector**
- Located on the frame, identity label indicates:
 - General data allowing identifying the leak detector.
 - Safety data allowing using the leak detector in good conditions.

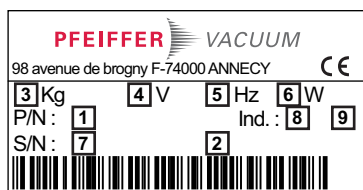

1	Part number
2	Designation
3	Net weight
4	Use voltage
5	Use frequency
6	Maxi power consumption
7	Serial number
8	Index
9	Manufacturing date

- Product customized in factory, according to customer order.

**PRODUIT PERSONNALISE
CUSTOMIZED PRODUCT**

- Located on the frame, this label indicates if “Bluetooth”, “Input/output board with Ethernet” or “Input/output board with Wi-Fi” options are placed in the detector.
If yes, their Mac addresses, required for their configuration, are indicated.



Product labelling

- Located on the frame, under the cover, this label indicates for each firmware load in the leak detector, its version and checksum.

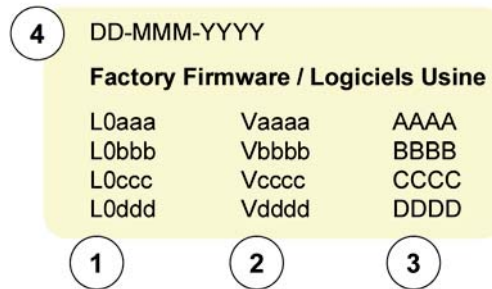

1	Firmware name
2	Firmware version
3	Firmware checksum
4	Label edition date

- Located on the frame, under the cover, this label indicates parameters values only necessary to Service Centers for the leak detector maintenance.

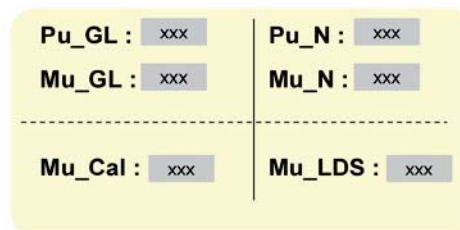

- Leak detector quality control comply at factory leaving.



- Leak detector conformed with the R.O.H.S. directives.



Product labelling

- Located on the detector, this label indicates that the product lifting must:
 - be made from the handling points identified with this label (rings, handles, ...),
 - respect the handling rules book considering its weight and dimensions.
 - See Operating Instructions for more details.

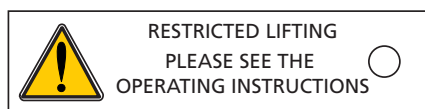

- Don't move the leak detector in operation in all positions.

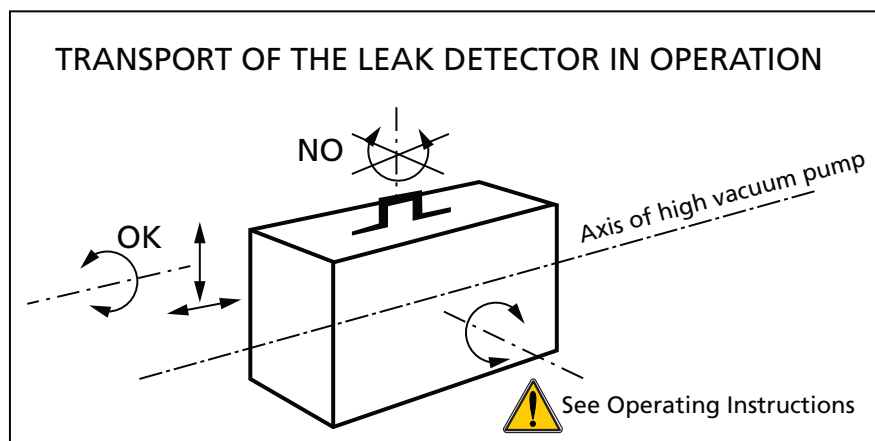

- Exhaust port: not to be blocked.

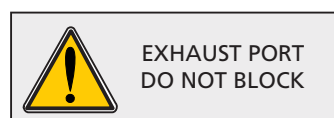

- Product drained before leaving factory: fill the primary pump with oil before running.

NOTICE
PUMP IS SHIPPED WITHOUT
 ● **OIL INSTALLED**
 consult maintenance manual
CAUTION

ATTENTION
POMPE LIVREE SANS HUILE
 ● **A L'INTERIEUR**
 consulter le manuel d'utilisation
ATTENTION

Product labelling

- This label indicates a detector ground point.



- Located on some electronic boards, this label indicates that some of the internal parts are energized and could cause electrical shocks in case of contact.



- Located on the frame, this label indicates that some of the internal parts are energized and could cause electrical shocks in case of contact. This label recommends disconnecting power supply cable and waiting 5 minutes before any maintenance operation.

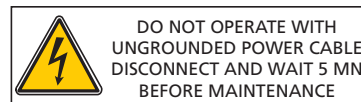

- Located on some electronic boards, this label indicates that some of the internal parts are energized and could cause electrical shocks in case of contact. This label recommends:
 - Do not using the leak detector with the power supply cable not connected to the ground,
 - disconnecting electrically the leak detector before any maintenance operation.

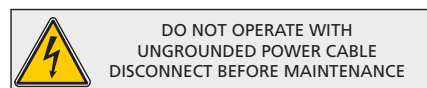

- Located on some electronic boards, this label indicates that some of the internal parts are energized and could cause electrical shocks in case of contact. This label recommends disconnecting electrically the leak detector before removing the cover.



Product labelling

Pumps

- Located on the rear of the pump, this label warns the user against possible risk of injury due to any hand contact with hot surfaces. It states that protective gloves should be used before performing any intervention.



- Located on the upper cover, this label indicates that due to its heavy weight the product should not be handled manually, but always through appropriate handling devices.



- Located on the upper cover, this label indicates that some of the internal parts are energized and could cause electrical shocks in case of contact. It advises to disconnect the pump before any intervention or to properly lock-out and tag-out the equipment breaker before any intervention on the pump.

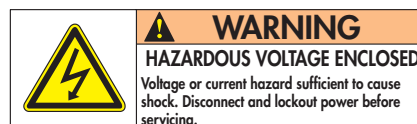

- Located on the upper cover, this label informs the user that moving parts present inside the pump could cause personal injury, like crushing or cutting. The user must keep all body parts away from moving parts.



Neutral gas purge and inlet vent connection

Products concerned

	Inlet vent	Neutral gas purge
ASM 182 / 192 T ASM 192 T2	✓	
ASM 182 / 192 TD+ ASM 192 T2D+	✓	✓ ⁽²⁾
ASM 142	✓ ⁽¹⁾	
ASM 142 D ASM Graph D+		✓ (MDP 5006 HDS) ⁽³⁾
ASM 142 S ASM 102 S		
ASM 122 D	✓	✓ ⁽²⁾
ASM 1002	✓	

(1) Requires a special inlet vent kit installation ( A 700).

(2) Male connector delivered with the leak detector ( F 800 - Ref. H116).

(3) Male connector not delivered with the leak detector.
Model : Male connector R 1/4 BSPT.

Connection to the leak detector

 B 210 / B 211

Neutral gas purge
ASM 182/192 TD+
ASM 192 T2D+
ASM 142 D

■ If the purge is connected to an insert gas, the primary pump will be purged with this inert gas: its supply pressure must be regulated (see purge flow §).

If the male purge fitting is installed and not connected to an inert gas, the primary pump will be purged with ambient air and an air flow is maintained inside the leak detector.

CAUTION

The manufacturer recommends that the primary pump be purged continuously whenever the leak detector is in operation. Premature failure of the primary pump may occur and the warranty may be affected if the male purge fitting is not used at all times: do not remove this purge. This can be done by connecting the purge to an insert gas with less than 5 ppm of helium or simply to ambient air with normal Helium concentration of 5 ppm.

Neutral gas purge
ASM 122 D

■ Even if the leak detector does not use the neutral gas purge, the male connector delivered with the leak detector should always be connected to leak detector.

Inlet vent

■ The inlet vent status (open or closed) depends on the parameters set by the operator ( C 500).

■ If no inlet vent system is connected, the inlet vent is connected to the ambient air.

Neutral gas purge and inlet vent connection

Use Neutral gas purge

- Used to limit the leak detector internal pollution.
- Used to accelerate the cleanup of the helium background noise in the pumps after detecting a significant leak.
- Make high sensitivity testing easier due to the decreasing and stabilization of the helium background noise.
- As a supplement to the neutral gas purge, use the "Depollution" function  C 560 (except ASM 142 S/ASM 102 S).

In case of a big flow of Helium into the leak detector (very big leak detected), the recovery time (time for the display to go back to normal Helium background value) is 10 times longer when the neutral gas purge is obturated than when it is open. In usual average test conditions, there is however no major difference.

Inlet vent

- Used to accelerate the cleanup of the helium background noise in the leak detector after detecting a significant leak.
- Make high sensitivity testing easier due to the decreasing and stabilization of the helium background noise.
- Allows to regulate the gas flow inside the leak detector, leak detector in stand-by.

Gas characteristics

Type

Nitrogen is typically the neutral gas used but you can use any gas on the condition that it is poor in helium (concentration ≤ 1 ppm).
Take care with the ambient air: it should not be polluted with helium.

Quality/purity

According to the installation or item to test. The gas should be clean, dry, without dust, no toxic.

Use pressure

0.3 ± 0.1 bar relative (≈ 20 psia/5 psig).

If the inlet vent pressure is too high, the inlet valve will always stay closed, off even if the inlet valve is «ON».

Purge flow

- ASM 122 D - ASM 142 D: ≤ 5 sccm
- ASM 182 TD+: ≤ 50 sccm

ASM 182: connecting the detector to the installation

CAUTION

Caution: exhaust port do not block

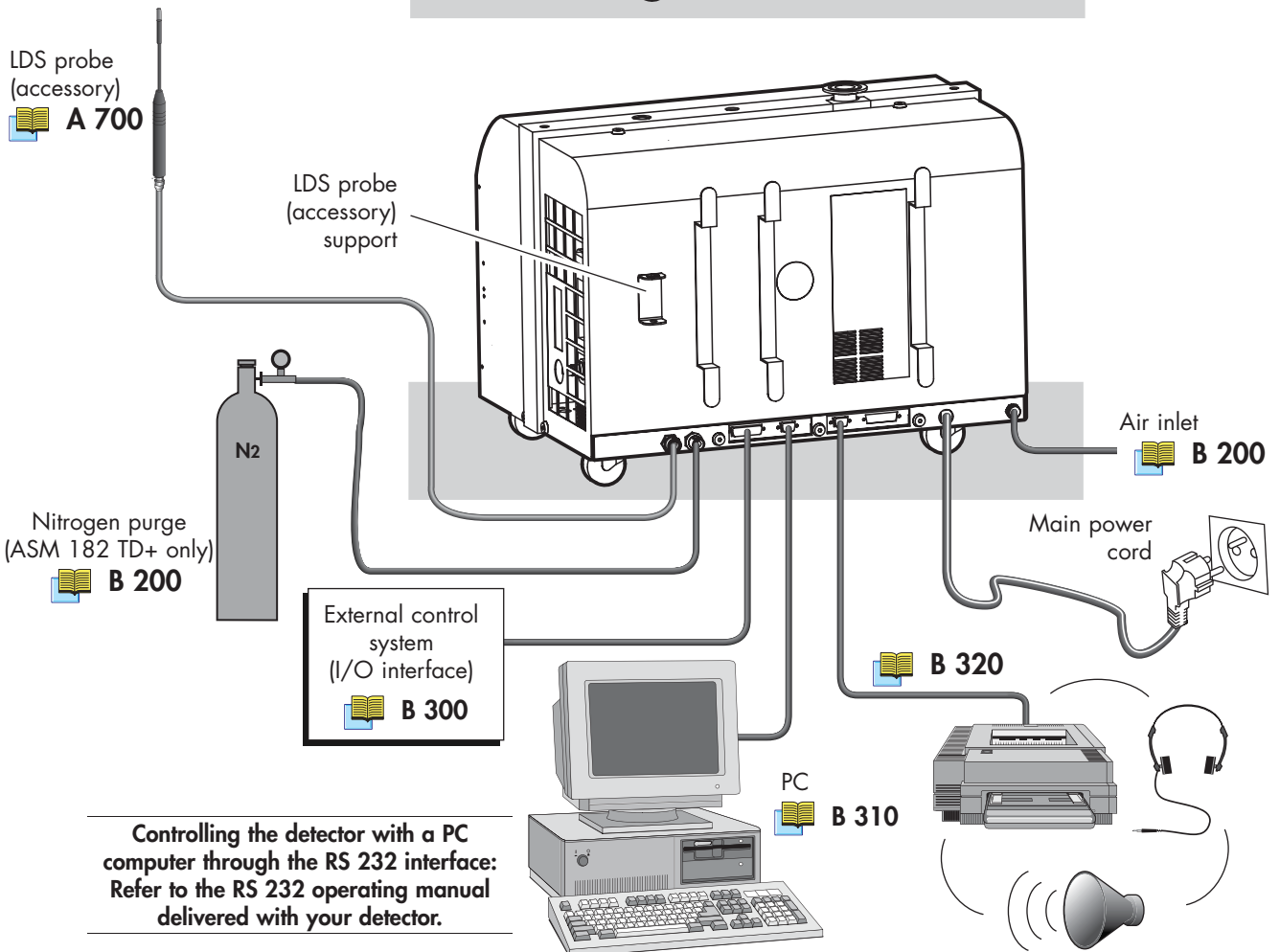
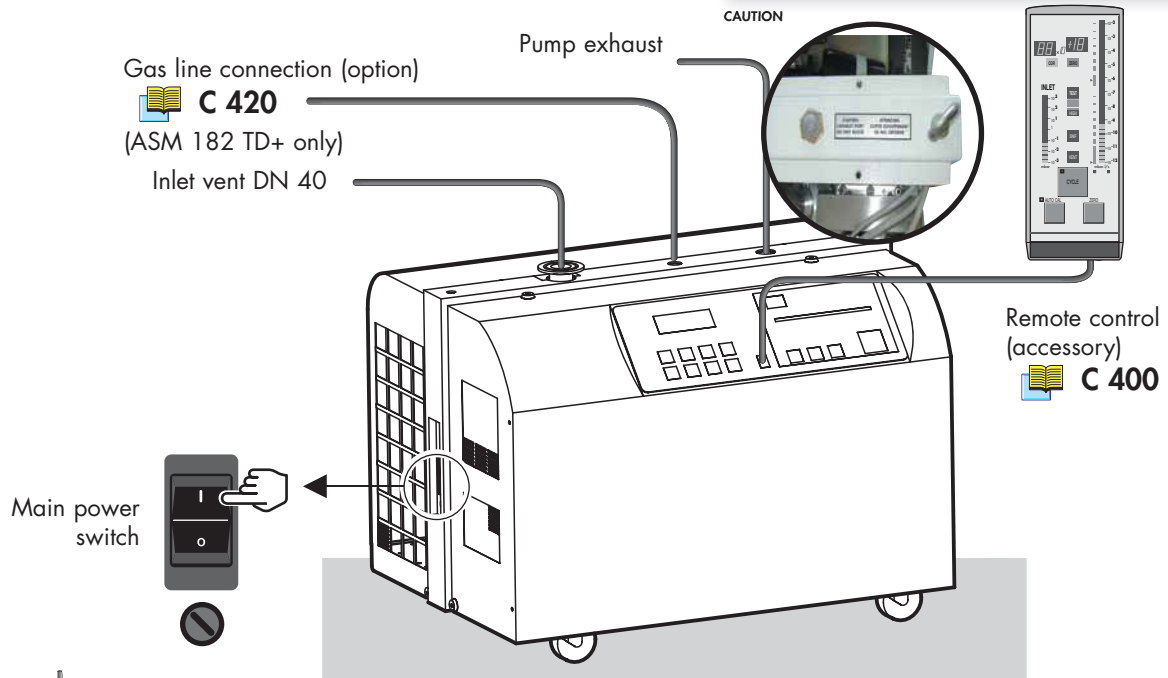

Controlling the detector with a PC computer through the RS 232 interface: Refer to the RS 232 operating manual delivered with your detector.

ASM 192: connecting the detector to the installation

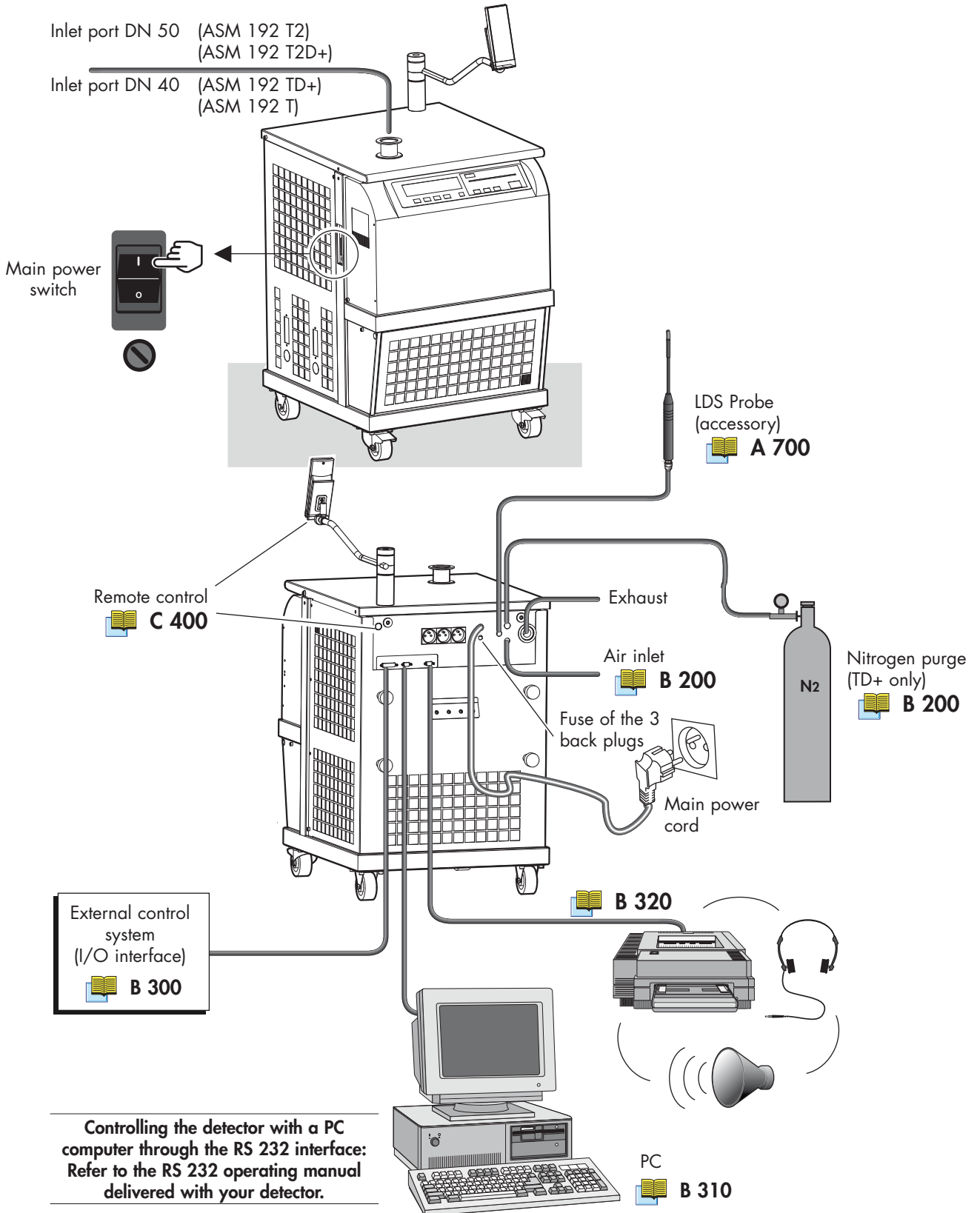

Controlling the detector with the I/O interface

Purpose of the I/O interface

The I/O interface makes it possible to control the leak detector with a PLC or any other external control device.

Location of the I/O interface

The I/O interface is available on a Sub. D 25 pin male connector located on the back of the leak detector.

 **B 210**

Prepare the connector wiring (Sub. D 25 pin female connector)

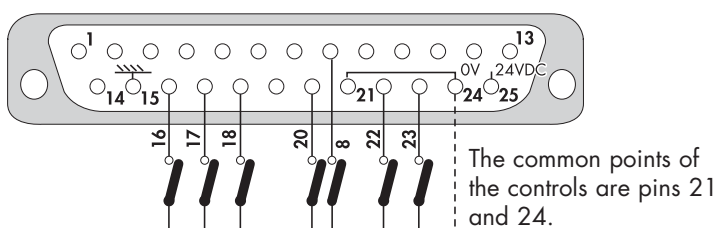

It is recommended to use a shielded cable which is grounded on the connector cap.

The controls (inputs)

23 Interface	Contact open: the filament command is valid. Contact closed: the filament command is invalid.
22 Calibration	Autocalibration sequence start
8 Cycle	Cycle start
20 Filament	Filament on
18 GL mode	Gross leak mode selection
17 LDS mode	Sniffing mode selection
16 Inlet vent	Vent mode selection

The signals (outputs)

Dry contacts:

Direct current: 60 V - 60 W or 2 A max

Alternative current: 40 V - 125 VA or 2 A max

1 - 2	Sniffer mode (LDS)
3 - 4	Gross leak mode
5 - 6	High sensitivity mode
7 - 9	Test cycle start
10 - 11	Filament on
12 - 13	Helium signal > Reject Set point
19 - 15	Analog output 0 - 10 VDC (inlet pressure)
14 - 15	0 - 8 VDC analog output (Helium signal)

Note:

15 = internal ground

24 = common (external ground)

21 = common (external ground)

 **G 300**

Controlling the detector with the I/O interface

24 V DC Power supply

Pin No	24 V DC power supply
25	<p>If SW2 on P0344 interface board is closed (upper position) ⇨ +24V DC (maximum current 350 mA) supplied by leak detector</p> <p>If SW2 is open (lower position) ⇨ (+) point for customer external power supply (24 V)</p>
24, 21	<p>If SW2 on P0344 interface board is closed (upper position) ⇨ External ground</p> <p>If SW2 is open (lower position) ⇨ (-) point for customer external power supply</p>

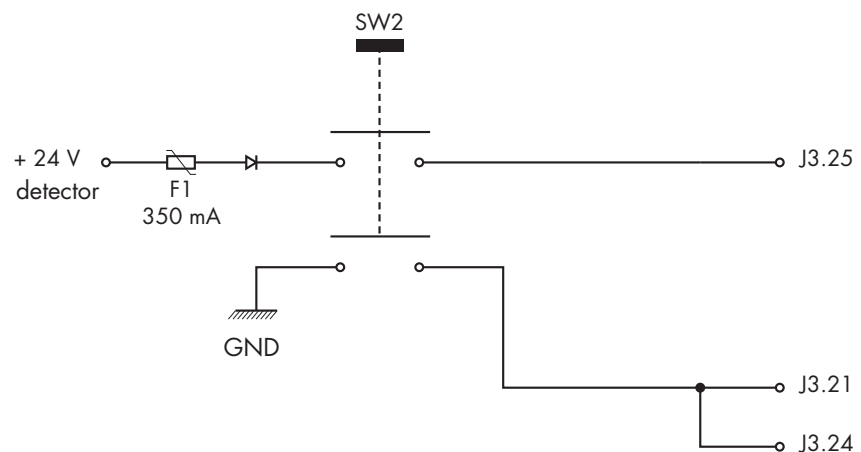

Controlling the detector with a PC computer through the RS 232 interface

Purpose of the PC computer interface

The RS 232 interface makes it possible to control the leak detector with a PC compatible computer.

Location of the RS 232 interface

It is a Sub D 9 pin Male connector.

Connect the detector to the installation  B 210/211

RS 232 interface instructions

A specific manual describes to the operator all the commands available with the RS 232 manufacturer protocol. It is delivery with your leak detector.

Commands available for your leak detector

Only the commands which correspond to the fonctions of your leak detector are available.

See details in the RS 232 operating manual.



RS 232 interface setting

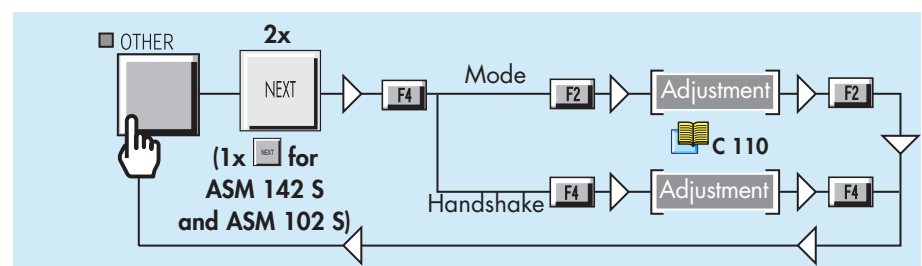

Connection checking of RS 232 interface

You can start up an autotest in order to check the connection PC/leak detector.

Leak detector stopped, connect the both ends of RS 232 cable (depending on wiring recommended) on each of Sub 9 pin connectors.

Controlling the detector with a PC computer through the RS 232 interface

Procedure 1 -

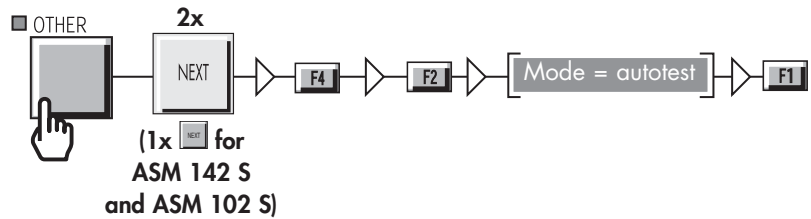

2 - The first line of LCD screen is:

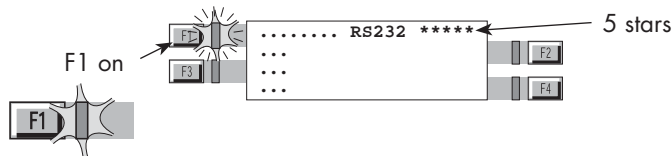

3 - the autotest is started and F1 flash on

Following different tests, the stars are replaced by numbers.
If the autotest is accomplished, the first line LCD screen become:

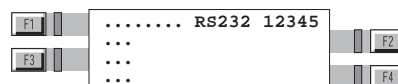

Connecting the detector directly to a printer or another device

Purpose of the printer interface

The Printer interface makes it possible to connect the leak detector to a printer, an external loudspeaker or a headphone.



Location of the printer interface

It is a Sub D 9 pin Male connector.

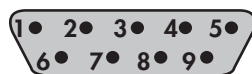
 B 210/211



Connector description

	Pin #	Function	Communication protocol	
	1	External loudspeaker	Mode	Asynchronous
	2	Rx	Bauds	9600
	3	Tx	Bits	8
	4	NA	Parity	None
	5	Ground	Stop bit	1
	6	Headphone	Parity control	None
	7	RTS		
	8	CTS		
	9	Internal use only. Don't connect it		

Headphone and loudspeaker  C 410

Communication mode description



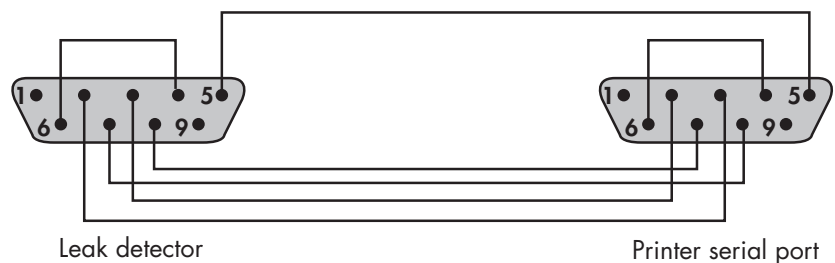

Configuration tickets are sent out.

Connection to the printer



Connecting the detector directly to a printer or another device

Tickets available

Ticket	Example	Print
Configuration	1	Only available for Customer Service
Internal calibration with internal leak	2	Automatic print after an internal calibration with internal/external leak: refer to  C 301
Internal calibration with external leak	3	
Calibration checking with internal leak	5	Automatic print after a calibration checking with internal leak: refer to  C 302
Test	6	Automatic print at the test end: refer to  C 211 / 212 <div style="background-color: #e0f0ff; padding: 5px; border: 1px solid #add8e6; margin-top: 10px;"> Memo function must be active  C 550 </div>

Connecting the detector directly to a printer or another device

Configuration ticket

1

ASM1002 CONFIGURATION TICKET

VERSION: L125v1.0 r00

DATE:Jan/01/2003 TIME:00:00:07

SET-POINTS MENUS

audio level:	3
digital voice level:	3
hard vacuum alarm:	fixed
hard vacuum reject point:	1.0E-07
sniffing alarm:	fixed
sniffing reject point:	1.0E-04
sniffer probe clogged reject:	1.0E-06
bargraph zoom on reject point:	no
depollution function:	off
pollution reject point:	1.0E-05
antipollution GL function:	on
pollution reject point:	3.0E-04
memo. function active:	no
memo. display timer:	no
memo. timer value(min:s):	00:10
cycle end function:	operator
roughing overlap timer:	on
roughing timer value(min:s):	00:10
test timer value(min:s):	00:10
start.timer value(min:s):	00:05
background suppression activation:	operator
trigger:	reject point
GL setpoint (mbar)	1.0E+02
Normal setpoint (mbar)	1.0E-01

SPECTRO MENUS

automatic calibration:	off
calibration check:	operator
every:	0050 cycles
every:	0010 hours

filament in use:	2
electronic zero:	110
acceleration voltage(V):	217
electronic current(mA):	0.0
sensitivity coefficient:	01.00
He calibrated leak location:	internal
value:	1.0E-07
unit:	mbar.l/sec
year:	2003
loss per year(%):	2.00
temperature(C):	20
temp.coefficient(%/C):	3.00

MAINTENANCE MENUS

high vac.mnt.periodicity(hours):	12000
high vac. mnt.due in(hours):	12000
filament#1 running time(hours):	0
filament#2 running time(hours):	0
customed mnt.period.(cycles):	5.0E+05
customed mnt.due in(cycles):	5.0E+05
bicolore remote:	yes
primary pump1 used:	yes
primary pump2 used:	no

OTHER MENUS

test mode selection:	normal
inlet vent mode:	chamber
inlet vent delay(sec):	0
inlet vent open timer us:	no
inlet vent timer value(min/sec):	00:09
hard vacuum correction:	off
hard vacuum cor.coefficient:	1.00E+00
sniffing correction:	off
sniffing cor.coefficient:	1.00E+00
unit:	mbar.l/sec
display language:	english
user interface:	#4
password value:	5555

TYPICAL VACUUM VALUES

Pu_gf:1.00000	Mu_gf :1.0E+06
Pu_n :1.00000	Mu_n :00001.0
	Mu_rld:00015.0

DATE AND TIME VALUES

last stop:	Jan/01/2003 00:00:00
last start:	Jan/01/2003 00:00:02
last calib.ok:	Jan/01/2003 00:00:00

detector counter (h:m:s):	00000:00:50
---------------------------	-------------

Connecting the detector directly to a printer or another device

Calibration ticket with internal calibrated leak

2

```

DATE:Jan/01/2003 TIME:00:03:17
ASM1002 CALIBRATION gas: He
unit: mbar.l/sec

CALIBRATED LEAK PARAMETERS:
location: internal
value: 1.0E-07
unit: mbar.l/sec
calibration year: 2003
loss per year (%): 2.00
calibration temperature (C): 20
temperature coefficient (%/C): 3.00
TARGET PARAMETERS:
current internal temperature (C): 25
target value: 1.2E-07
ELECTRONIC ZERO:
done: yes
PEAK SEARCH :
search yes
SIGNAL RECORDS (no calibrated):
global: 1.3E-07
background: 7.1E-11
CALIBRATION INFORMATIONS:
total time(sec): 74
result: COMPLETED

CURRENT ASM1002 CALIBRATION:
DATE:Jan/01/2003 TIME:00:03:00
Fil:1 le=0.6 Vacc=232 Coef_sens:00.86
    
```

Calibration ticket with external calibrated leak

3

```

DATE:Jan/01/2003 TIME:00:05:03
ASM1002 CALIBRATION gas: He
Unit : mbar.l/sec

CALIBRATED LEAK PARAMETERS:
location: external
value: 1.0E-05
unit: mbar.l/sec
calibration year: 2003
loss per year (%): 2.00
calibration temperature (C): 20
temperature coefficient (%/C): 3.00
TARGET PARAMETERS:
current external temperature (C): 22
target value: 1.1E-05
ELECTRONIC ZERO:
done: no
PEAK SEARCH :
search no
SIGNAL RECORDS(no calibrated):
global: 2.0E-05
background: 3.0E-09
CALIBRATION INFORMATIONS:
total time(sec): 64
result: COMPLETED

CURRENT ASM1002 CALIBRATION:
DATE:Jan/01/2003 TIME:00:05:02
Fil:1 le=0.6 Vacc=232 Coef_sens:00.52
    
```

Connecting the detector directly to a printer or another device

Calibration checking ticket with internal leak

5

```

CALIBRATION INFORMATIONS:
DATE|Jan/01/2003 TIME|01:19:23
current internal temperature(C)|                24
current coef.sens|                             00.78
global rate|                                   1.10E-07
background rate|                               5.22E-11
calibrated leak-rate|                           1.10E-07
target value|                                  1.10E-07
percent allowance (+/-)|                       15
RESULT(%)|                                     -0
    
```

Test ticket

6

```

DATE:Jan/01/2003
HOUR      CASE      PRESSURE  LEAKRATE
00:28:26  start    3.8E+01  3.4E-11
00:28:55  GL       1.2E-02  1.4E-09
00:29:40  NR       6.3E-05  9.1E-06
00:29:45  stop     5.8E-05  1.1E-05
NR
    
```

Leak value

```

DATE:Jan/01/2003
HOUR      CASE      PRESSURE  LEAKRATE
01:02:31  start    6.5E+01  4.8E-11
01:02:32  GL       4.6E+01  4.8E-11
01:02:33  NR       5.9E-02  1.8E+00
01:02:36  stop     9.9E-05  1.3E-05
NR
FAIL
    
```

Leak value

Test result if Memo function active

Memo function  C 550

Before starting up the leak detector ASM 182 series

Please acquaint oneself with the safety instructions sheet ( B 100) and the installation sheet ( B 110)

The performance of the detector (pumping speed, accuracy and reliability) depends on:

- the vacuum connections
- the frequency and quality of maintenance
- the helium calibration.

Check power voltage

Check that the power voltage is compatible with the power configuration of the leak detector: check the indications of the label located close to the power switch.

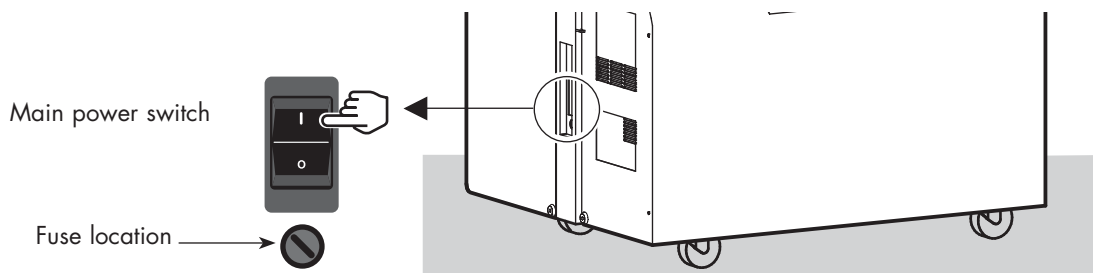

Fuse: 100 - 130 V..... 6.3 A
200 - 240 V..... 3.15 A

Installation

Position the unit so there is no possible risk of it falling or tilting.

The leak detector is equipped with 4 pivoting wheels without brake, (2 wheels with brake on the console version).

So:

If the detector is placed on a high surface, the operator should take care to lock the wheels of the detector.

It's forbidden to place the leak detector on a sloping surface (> 1 %) without take precautions for its translation stop.

Before starting up the leak detector ASM 182 series

Check the oil level of the roughing pump (ASM 182 T)

The pump has been drained: a label affixed on the cover of the unit indicates this and the filling oil is supplied.

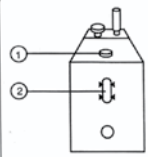
ATTENTION Pompe primaire sans huile	IMPORTANT Roughing pump without oil
	MISE EN SERVICE 1. Mettre de l'huile dans la pompe. 2. Pompe arrêtée, le niveau d'huile doit correspondre au milieu du voyant.
	BEFORE STARTING 1. Fill the mechanical pump with oil. 2. Oil level must be on the middle of the sight glass when mechanical pump is not running.

Maintenance of the primary pump E 750

CAUTION

The pump will be damaged if it runs without oil (> 5 mn).

CAUTION

The oil required for the first use is supplied with the detector.
 Replacement of oil is the user's responsibility.
 The pumps have been tested with A200 oil.
 The technical characteristics of the pump are guaranteed only with the recommended oil.

Before starting up the leak detector ASM 192 series

Please acquaint oneself with the safety instructions sheet ( B 100) and the installation sheet ( B 110)

The performance of the detector (pumping speed, accuracy and reliability) depends on:

- the vacuum connections
- the frequency and quality of maintenance
- the helium calibration.

Check power voltage

Check that the power voltage is compatible with the power configuration of the leak detector: check the indications of the label located close to the power switch.

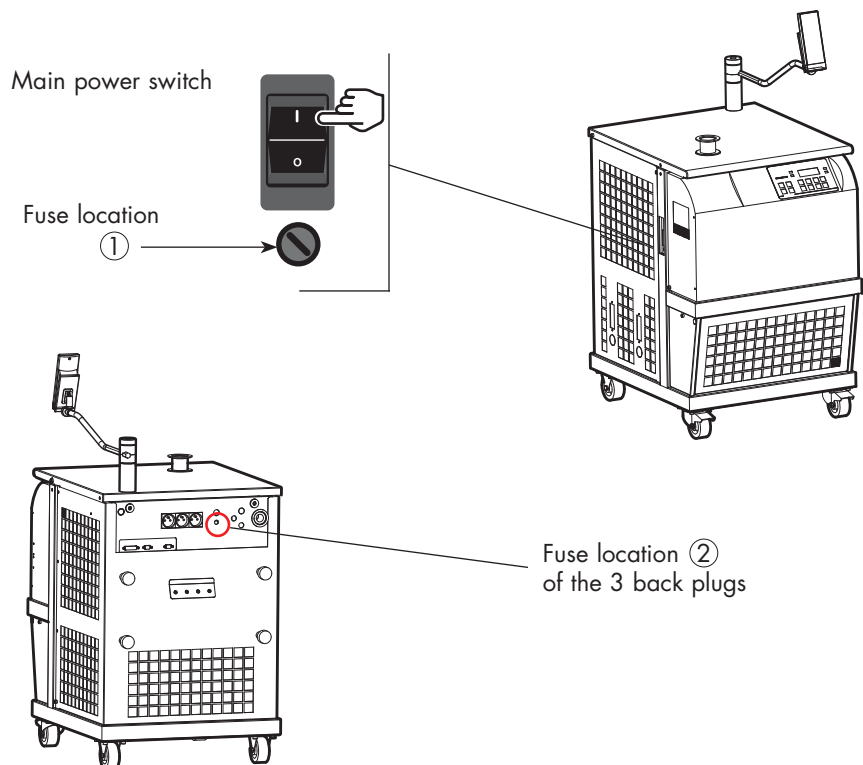

Fuse ①: 100 - 130 V..... 6.3 A
200 - 240 V.....3.15 A

Fuse ②: All voltage : 4 A

Before starting up the leak detector ASM 192 series

Check the oil level of the roughing pump (ASM 192 T / T2)

The pump has been drained: a label affixed on the cover of the unit indicates this and the filling oil is supplied.

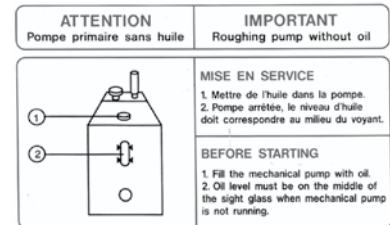

Maintenance of the primary pump E 750

CAUTION

The pump will be damaged if it runs without oil (> 5 mn).

CAUTION

The oil required for the first use is supplied with the detector.
 Replacement of oil is the user's responsibility.
 The pumps have been tested with A200 oil.
 The technical characteristics of the pump are guaranteed only with the recommended oil.

Installation

Position the unit so there is no possible risk of it falling or tilting.

The leak detector is equipped with 4 pivoting wheels without brake, (2 wheels with brake on the console version).

So:

If the detector is placed on a high surface, the operator should take care to lock the wheels of the detector.

It's forbidden to place the leak detector on a sloping surface (> 1 %) without take precautions for its translation stop.

Before starting up the leak detector ASM 192 series

Remote control support installation

5



- Remove the 4 liftings rings and screw them to the back of the leak detector. Cut the clamps.

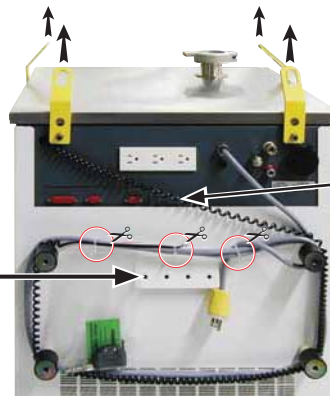

Remote control cable

Fix the remote control to its cable.

- Unpack the remote control support.
- Take the nut out.

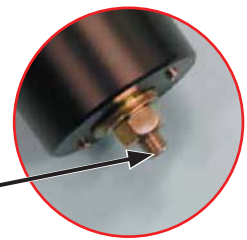

Access to the internal components  E 110

- Fix the remote control support on the work table and screw it.

Work table

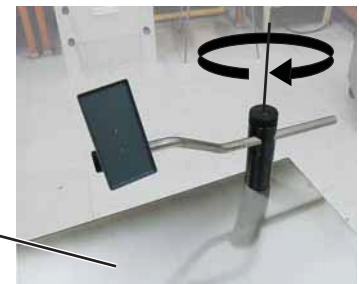

- Fix the remote control to its cable.





ASM 182 T - ASM 192 T - ASM 192 T2 Operating instructions Detailed contents

Preliminary remarks Throughout this operating manual, you could find this type of message “**Summary of screen**  **C 140**”: it refers to a specific chapter of the operating manual. Please read it for further information.

C 100 *Factory configuration of the leak detector parameters*

- Parameters configuration

C 110 *Operating principle of the control panel*

- General
- Graphic interface option
- Control keys
- Menu selection access keys
- Parameter function keys
- Description of access keys
- Values adjustment with the control panel

C 120 *Setting and maintenance part presentation of the control panel*

- Levels
- Parameters setting and application depending on level and display of the user interface

C 130 *Access to level - Password*

- To access to level 
- Change password

C 140 *Summary of screens*

- Other menu
- Spectro menu
- Set point menu
- Maintenance menu

C 200 *Starting up / Switching off the leak detector*

- Starting up after an unused/storage period
- Starting up the leak detector
- Switching off the leak detector
- Recommended procedure



Operation

ASM 182 T - ASM 192 T - ASM 192 T2 Operating instructions Detailed contents

C 210

How to use the leak detector: 2 methods

- How to use your leak detector?
- Hard vacuum test method
- Sniffing test method

C 211

Operation of the leak detector

- Hard vacuum test
- Sniffing test
- Sniffer probe clogged reject point
- Adjust vacuum/sniffing alarm reject point

C 300

Calibration of the leak detector

C 301

Basic internal calibration of the leak detector

- Purpose of the internal calibration
- When should an internal calibration be performed?
- Internal calibrated leak
- Internal calibration with the internal He calibrated leak
- Internal calibration with an external calibrated leak

C 302

Advanced internal calibration of the leak detector

- Introduction
- Activation/deactivation of the internal calibration
- Checking function

C 303

External calibration of the leak detector

- Purpose of the external calibration
- External calibrated leak
- Digital and analog display
- External calibration procedure
- Checking function with an external calibrated leak

C 304

Correction factor

- Definition
- Activate/Deactivate the correction factor VACUUM/SNIF COR Adjustment
- General notes (in vacuum or sniffing test mode)

C 305

Calibrated leak values programming

- Different types of calibrated leaks
- Programming the calibrated leak parameters



ASM 182 T - ASM 192 T - ASM 192 T2 Operating instructions Detailed contents

C 306

Adaptor for calibrated leak in sniffing mode

- How to use the adaptor?
- Notes

C 400

Remote control

- Remote control interface
- Remote control connecting
- Remote control choice
- Use and display

C 410

Headphone and loudspeaker

- Level adjustment
- Accessories
- Configuration

C 430

3 masses option

- Purpose
- Gas selection
- Calibration in Hydrogen or Helium 3

C 440

Control panel with graphic interface

- Graphic interface purpose
- Leak detector software version
- Automatic standby screen
- Use caution
- Control panel interface
- Change of interface
- Operating principle of the standard interface
- Operating principle of the graphic interface
- Selection of the graphic interface use mode
- Graphic interface description
- Graphic interface setting
- Memorized graph
- Animated synoptic

C 450

Long distance sniffer probe and Helium spray gun

C 500

Inlet vent

- Choices proposed to the operator
- Air vent purpose
- Air vent Opening/Closing
- Air vent adjustment



Operation

ASM 182 T - ASM 192 T - ASM 192 T2 Operating instructions Detailed contents

C 510

Bargraph zoom

- Purpose
- Activate/deactivate the bargraph zoom
- Analog display
- Zero function & Bargraph zoom

C 520

Audio alarm / Digital voice

- Audio alarm definition
- Digital voice definition
- General
- Sound level
- Adjustment

C 530

Cycle end

- Purpose of the cycle end
- Activate/Deactivate the Cycle end

C 540

Zero function

- Purpose
- Activate the zero function
- Deactivate the zero function
- Activation/Deactivation of the background
- Display

C 550

Memo function

- Purpose
- Activate/Deactivate the memo function

C 560

Helium pollution prevention

- Purpose
- Activate/Deactivate the Helium pollution prevention

C 570

Date - Time - Language - Unit

- Adjustment procedure

C 580

Fault / information indicator and display

- Fault and information
- Faults
- Information
- List of messages

Factory configuration of the leak detector parameters

Parameters configuration

The following list indicates the factory configuration of the leak detector parameters.

When the leak detector is switched off, all set parameters are memorized and values are kept for the next start-up.

We advise you to note in the "Customer modification" column, the parameter values modified for your application.

Parameters	Configuration		
	Factory	Customer modification	
Test mode	High sensitivity		C 210
Sniffer probe clogged threshold	$1 \cdot 10^{-6}$ mbar.l/s		C 211
Auto-calibration Checking Auto-checking every ... Auto-checking every ...	On Operator 10 hours 100 cycles		C 302
External calibrated leak in test External calibrated leak in sniffing	$1 \cdot 10^{-7}$ mbar.l/s $5 \cdot 10^{-6}$ mbar.l/s		C 303
GL correction GL correction value Sniffing correction Sniffing correction value	Off 1 Off 1		C 304
Calibrated leak parameters	See calibration certificate of the internal calibrated leak delivered with the detector.		C 305
Password	5555		C 130
User interface level	2		C 120
Audio alarm Voice synthesis Reject point in hard vacuum Reject point in sniffing	3 4 $1 \cdot 10^{-8}$ mbar.l/s $1 \cdot 10^{-6}$ mbar.l/s		C 520
Detector Inlet vent Inlet vent activation Delay Open timer use Timer	Off Operator 0 No 00:01		C 500

Factory configuration of the leak detector parameters

Parameters	Configuration		
	Factory	Customer modification	
Depollution Depollution reject point	On 1.10 ⁻⁵ mbar.l/s		C 560
Memo function Display timer Display timer value	No No 00:10		C 550
Bargraph zoom	No		C 510
Cycle end Roughing timer Roughing timer value Measure timer value	Operator Yes 00:10 00:10		C 530
Background suppression Trigger	Operator Reject point		C 540
Date - Time Language - Unit	Factory leaving Requested in the customer order		C 570
Gas for 3 masses option	He		C 430
Maintenance required Maintenance pump (initial value)	1.10 ⁶ cycles 12 000 h		D 100

Operating principle of the control panel

General

Operator interface  A 500

If a key (sensing switch) is depressed when its function is not available or not authorized, a brief audio signal is emitted.

Graphic interface option

If your control panel is equipped with a graphic interface, please refer to the sheet  C 440 which completed this sheet.

Control keys



The LED indicator is **ON** when the control key is activated (ex.: Sniffer ON).



The LED indicator is **OFF** when the control key is deactivated (ex.: Sniffer OFF).



Menu selection access keys

The LED indicator comes **ON** after depressing the key. It activates the menu. Then the corresponding menu is shown on the alphanumeric display.



Pressing the corresponding Menu selection key a second time deactivates the menu. The LED indicator is then turned **OFF** and the previous screen is displayed again.



Standard

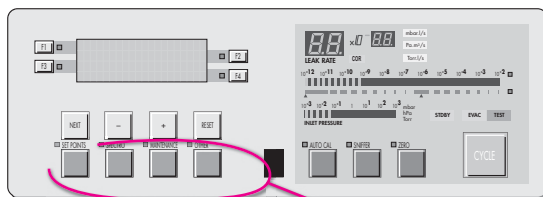

Option/Accessory

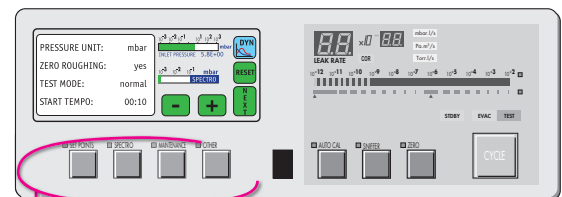

or
or
or

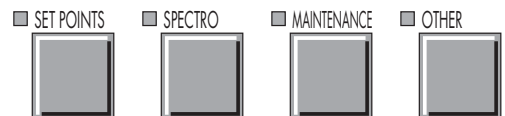

Menu selection access keys

Operating principle of the control panel

Parameter function keys

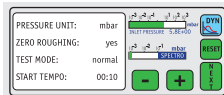
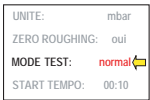
Standard control panel	Control panel with graphic interface (option/accessory)
	
<ul style="list-style-type: none"> To access to the parameter to be changed, there are up to 4 function keys available on the alphanumeric display (F1, F2, F3 and F4). Only one parameter key can be activated at a time. 	<ul style="list-style-type: none"> No function keys : to access to the parameter to be changed, press on the parameter value. Only one parameter value can be activated at a time.
<p>Press F1 = press on the 1st line red value</p> <p>Similarly:</p> <p>F2 → 2nd line, F3 → 3rd line ; F4 → 4th line</p> <p>Note: In the operating manual, all the functions are explained with F1 to F4 function keys.</p>	
<ul style="list-style-type: none"> The LED indicator is ON when the corresponding function key is available: the modification of the parameter displayed on the line is authorized. 	<ul style="list-style-type: none"> The value parameter is red when the corresponding parameter is available for modification.
<ul style="list-style-type: none"> Press the function key: the LED indicator will flash: the modification can be performed. It is possible to escape and reset the previous value by pressing RESET key or the active menu selection key. 	<ul style="list-style-type: none"> Press on the value: a arrow appears. the modification can be performed.  <p>It is possible to escape and reset the previous value by pressing RESET key or the active menu selection key.</p>
<ul style="list-style-type: none"> Once the parameter is modified, pressing the function key again validates it: the LED indicator remains ON and stops flashing. 	<ul style="list-style-type: none"> Once the parameter is modified, pressing the red value again validates it: the arrow disappears.

Operating principle of the control panel

Description of access keys



Next menu or next step of a function, Next PARAMETER DIGIT, WARNING/ERROR message display on the LCD when an error is detected.



Resets original parameter value (before a new parameter value is validated) and deactivates the parameter key.



YES, or ON, or OPEN, or active, or increase value, or increase audio volume, or select more sensitive test mode.

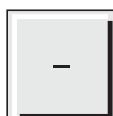

NO, or OFF, or CLOSE, or deactive, or decrease value, or decrease audio volume, or select less sensitive test mode.

Values adjustment with the control panel

In many menus, some values can be adjusted (reject point, password, timer, ...).

Please follow the procedure described below.

Procedure

Press function key of the desired line (where the value needs to be adjusted).

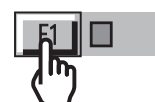

For each parameter, use modification keys in order to adjust the value and go to the next parameter.

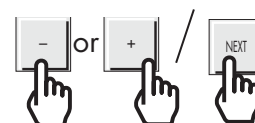

Repeat the same operation as needed.

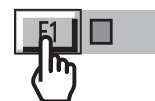

After the last modified parameter, press again the function key to validate the changes.

Setting and maintenance part presentation of the control panel

The control panel can be divided into two different sections.

- The section located on the right of the control panel is dedicated to the user.
- The section located on the left of the control panel dedicated to the setting and maintenance (adjustments, functions, menu access, etc.).

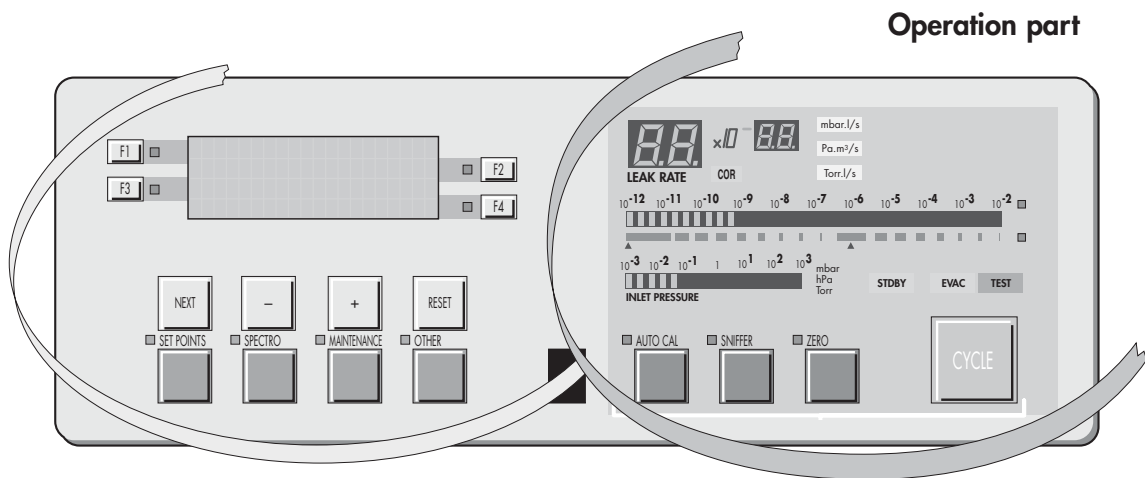

Setting and maintenance part

- Levels**
- The detector offers **4 user interface levels** for this section to accommodate any application requirements.

Description

	Setting and maintenance part	User part
Level ①	This level has very limited information on the alphanumeric display (LCD). This level is generally selected for production types of applications.	No access to control keys (Cycle key included)
Level ②	This level allows the operator to visualize some parameters without the possibility of making any changes. Same as Level ①, this level is usually selected for production types of applications.	Access to all the control keys
Level ③	Same as level ② but with possibility to set some parameters. This level is generally selected for maintenance applications.	
Level ④	This level allows access to all the parameters and is generally used for settings all the parameters. Note: When switching from level ④ to any other level, the switch can be performed without using the password. This level is generally selected for R&D applications.	

Setting and maintenance part presentation of the control panel

Which is your user interface level?

In order to find out what is the current interface level, follow the sequence described below:

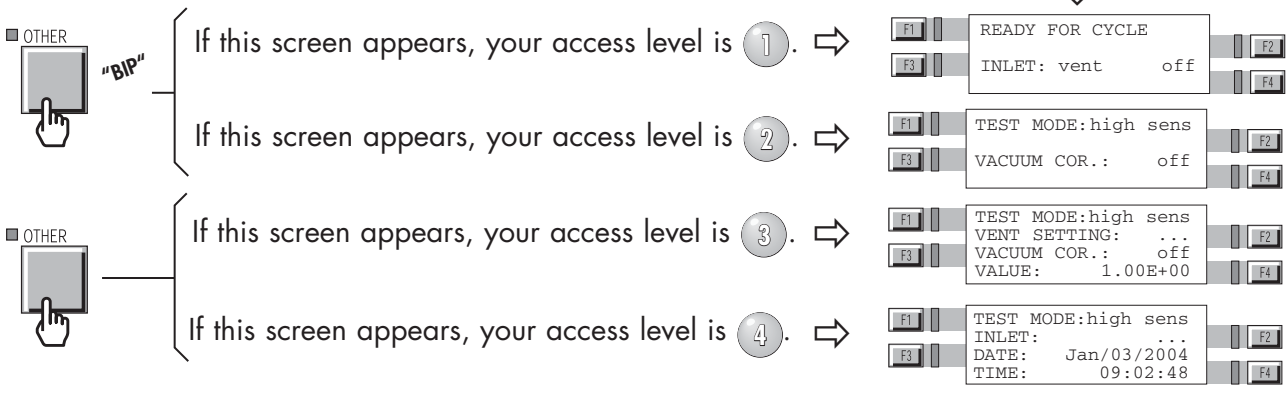

To change user interface level

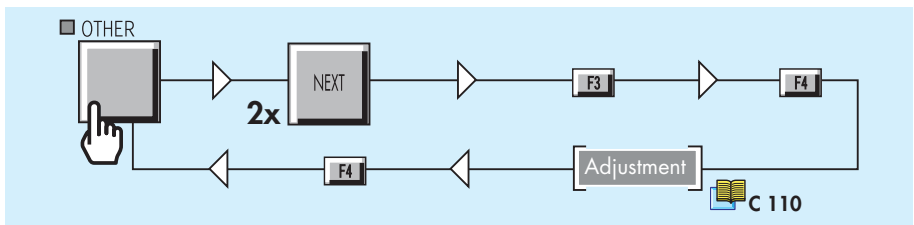

Setting and maintenance part presentation of the control panel

Parameters setting and application depending on level and display of the user interface

Function (with its associated parameters)		User Interface				Detector		
		Level required for setting parameters				ASM 142 ASM 142 D ASM Graph ASM Graph D ASM Graph D+ ASM 122 D ASM 182 ASM 192 T ASM 192 T2 ASM 182 ASM 192 TD+ ASM 192 T2D+	ASM 142 S	ASM 102 S
Level 1	Level 2	Level 3	Level 4					
RS 232	RS 232 operating manual				✓	✓		
User interface	C 120				✓	✓	✓	✓
Password	C 130				✓	✓	✓	✓
Test mode	C 210			✓	✓	✓		
Sniffer probe clogged threshold	C 211				✓	✓	✓	✓
Hard vacuum/Sniffing reject point	C 211			✓	✓	✓		
Auto-calibration (setting)	C 302				✓	✓	✓	✓
External calibration	C 303			✓	✓	✓		
Correction factor	C 304				✓	✓	✓	✓
Calibrated leak	C 305				✓	✓	✓	✓
Inlet vent	C 500		✓	✓	✓	✓		
Bargraph zoom (requires the remote control accessory)	C 510				✓	✓	✓	✓
Audio alarm	C 520			✓	✓	✓	✓	✓
Digital voice	C 520			✓	✓	✓	✓	✓
Cycle end	C 530				✓	✓		
Zero function	C 540				✓	✓		
Memo function	C 550				✓	✓		
Helium pollution prevention (depollution)	C 560				✓	✓		
Date - Time - Language - Unit	C 570				✓	✓	✓	✓
Gas line	C 420				✓	✓ (*)		
3 masses option	C 430				✓	✓		✓
Maintenance required	D 200				✓	✓	✓	✓
Filament information	E 400				✓	✓	✓	✓
Calibration mode	C 300				✓			✓

(*) only ASM 182 TD+

Access to level 4 - Password

A help for control panel utilization/access.

Operating principle of the control panel

C 110

Setting and maintenance part presentation of the control panel

C 120

Access to parameters and parameters active depending on authorization

Access to level 4 - Password

C 130

Summary of screens

C 140

Complete displays list with access way and associated sheet

To access to level 4

Notes:

This procedure allows the operator (with level 1, 2 or 3) to access temporary to level 4 to adjust a function but the level 4 isn't kept in memory and the unit will go back to its previous interface level afterwards. If the operator wants to maintain the level 4, he must change the user interface level (see "To change user interface level").

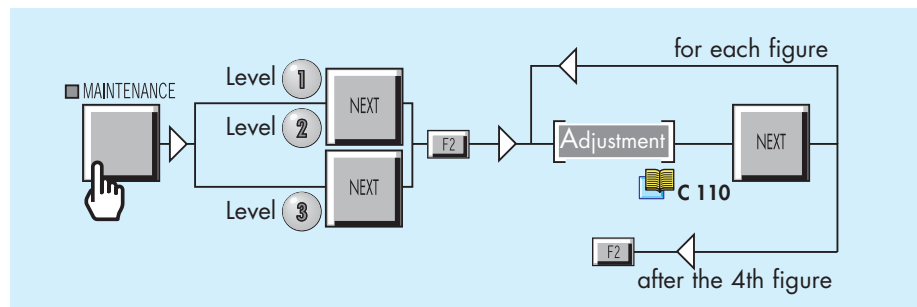

The operator has now reached the level 4. The software will automatically come out of level 4 and go back to the previous used level.

Change password

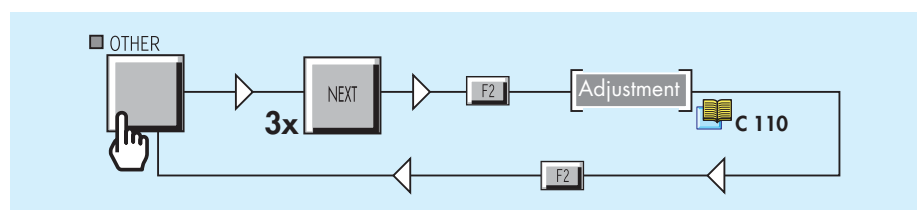

Summary of screens



Stand-by

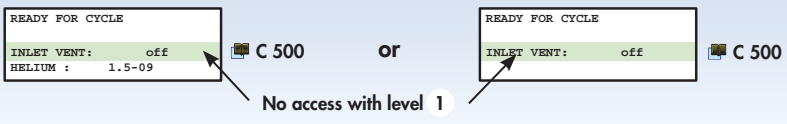

Starting-up

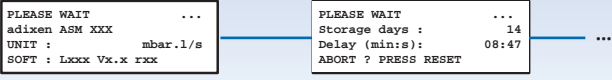

Password



Internal calibration with external calibrated leak

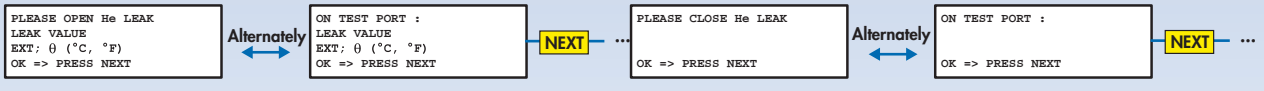

External calibration

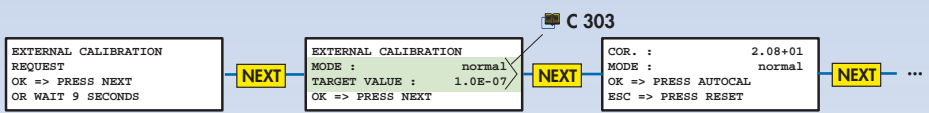

Summary of screens

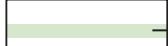
Other menu  → value/function adjustable

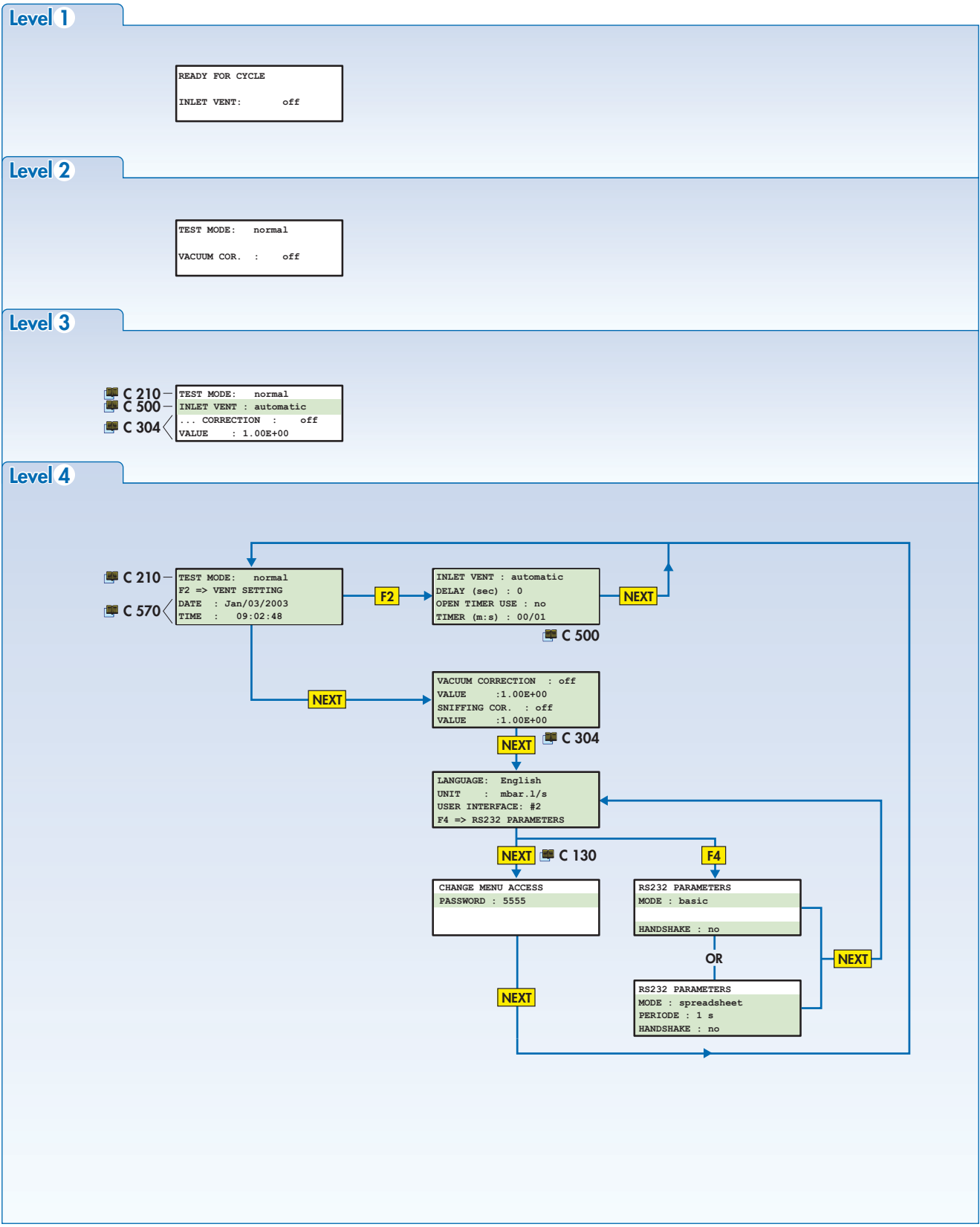

GB 01 671 - Edition 05 - March 12

Summary of screens

 → value/function adjustable

Spectro menu

Level 1

```

READY FOR CYCLE
INLET VENT:   off
    
```

Level 2

```

SPECTROMETER
FILAMENT#1   :   on
TRIODE PRESSURE : 1
MARGIN       : 100%
    
```

Level 3

```

SPECTROMETER
FILAMENT#1   :   on
TRIODE PRESSURE : 1
MARGIN       : 100%
    
```

E 400

Level 4

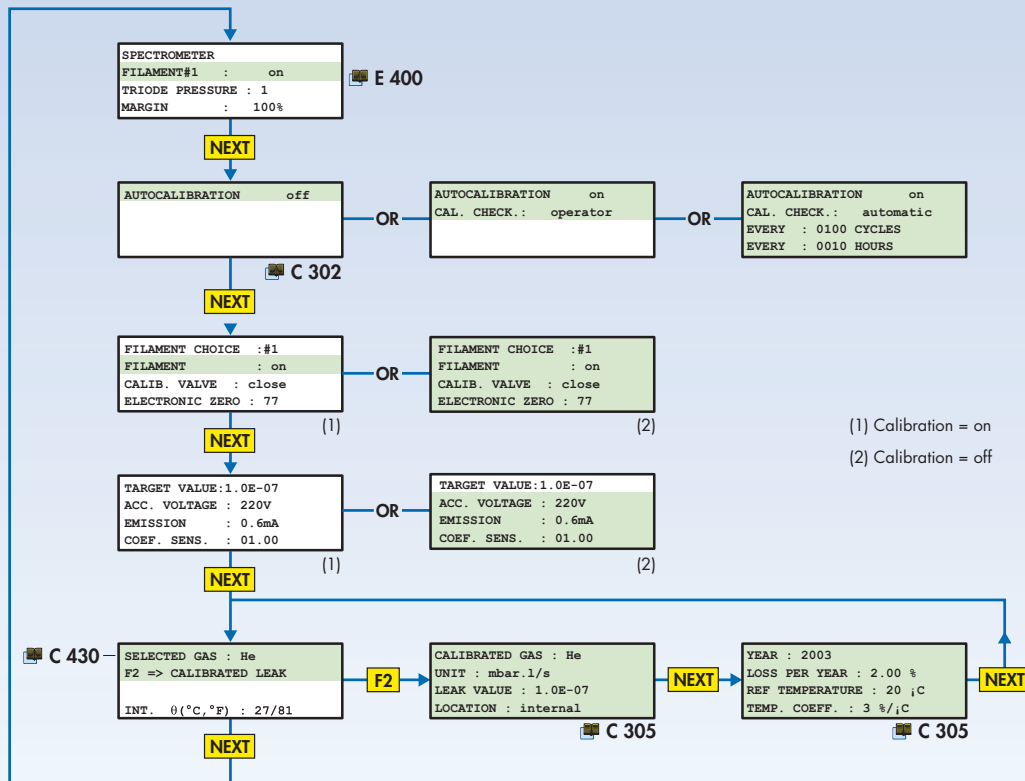

Summary of screens



Set point menu

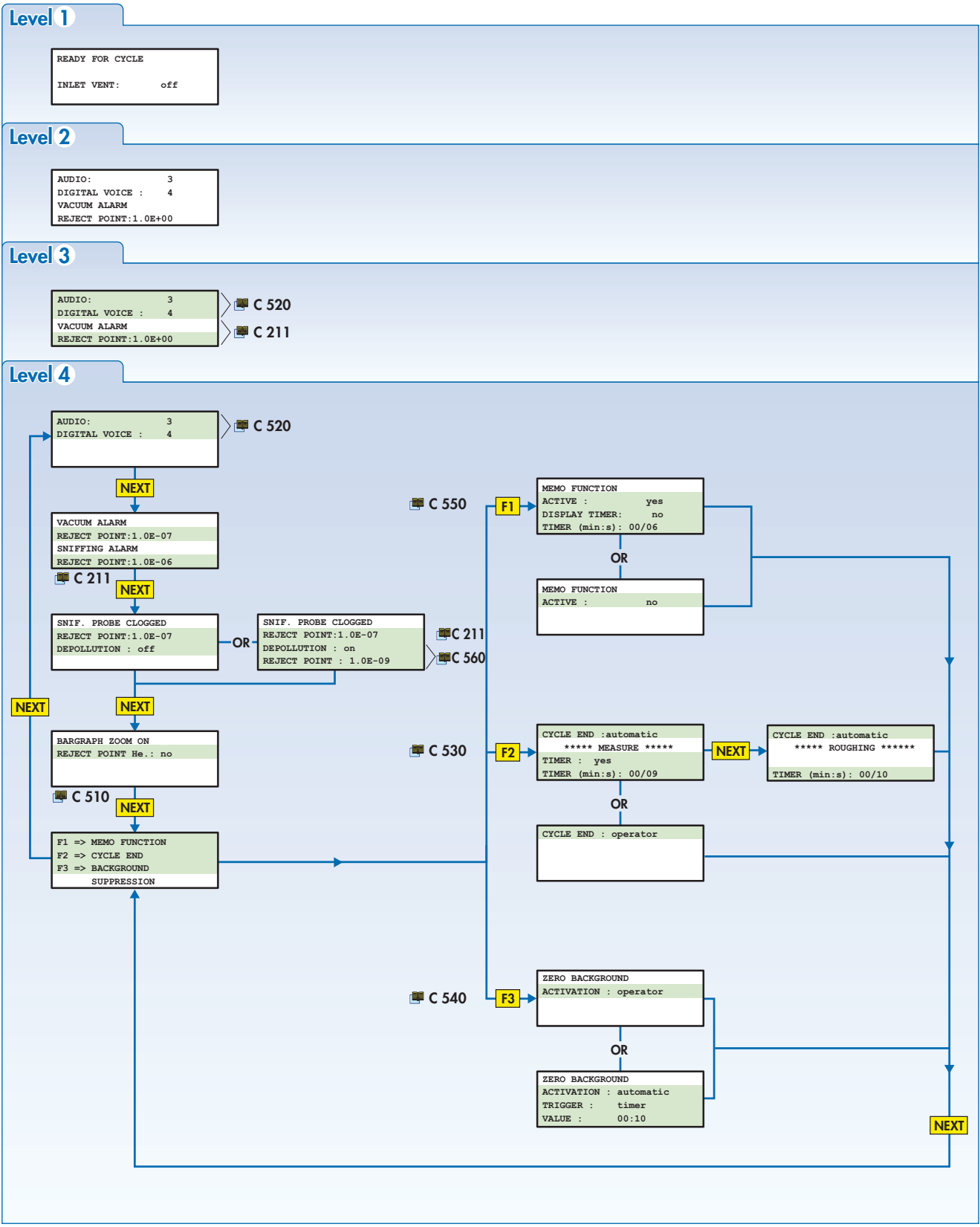

GB 01 671 - Edition 05 - March 12

Summary of screens

 value/function adjustable

Maintenance menu

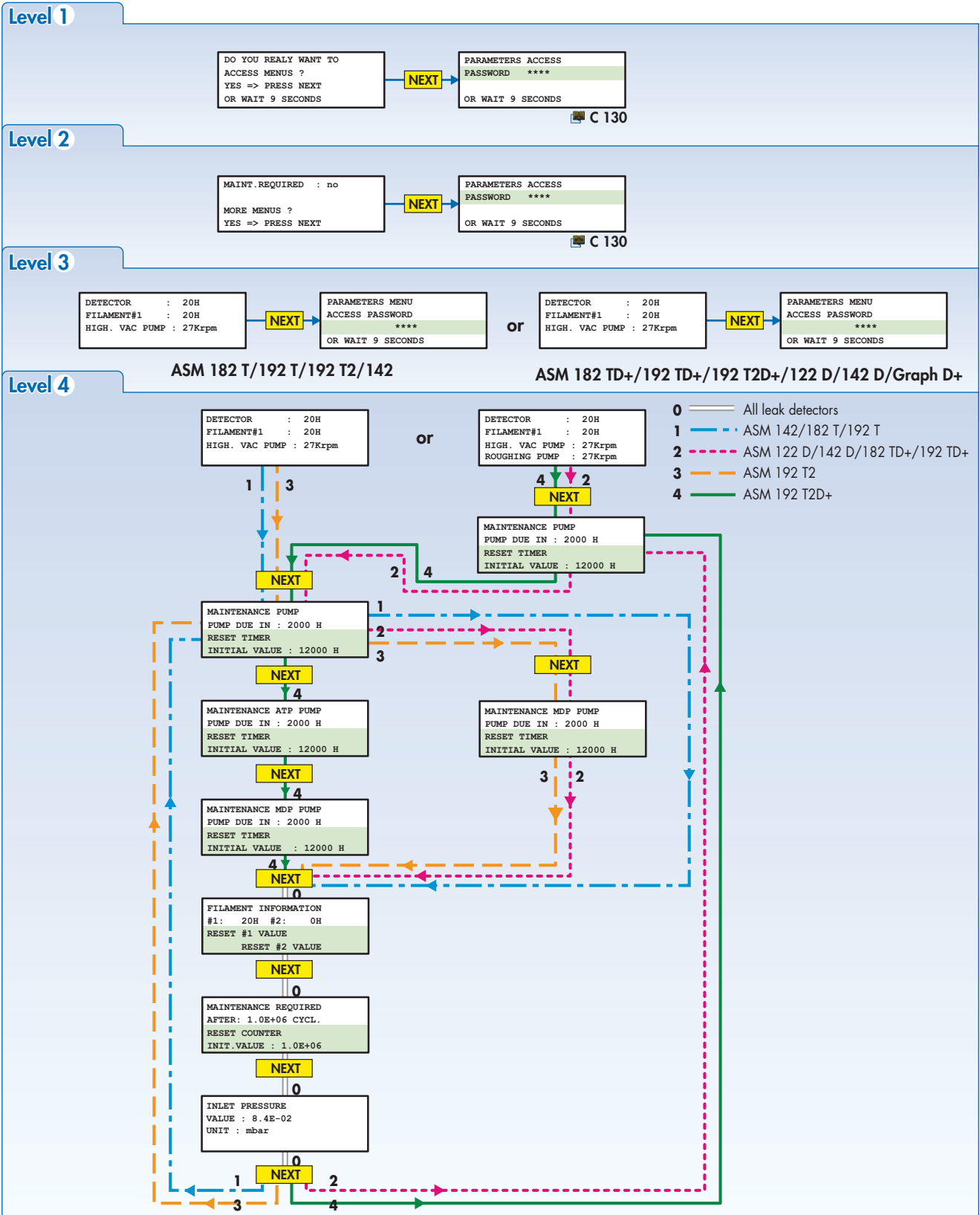

Starting up / Switching off the leak detector



Starting up after an unused/storage period

- If the operator uses the leak detector, after an unused or storage period, there is an additional time at the normal start-up time for outgassing:
 - inactivity period ≤ 10 days $\Rightarrow + 5$ s maxi (ASM 182, 192, 1002).
 - 10 days $<$ inactivity period ≤ 23 days $\Rightarrow + 3$ min.
 - inactivity period > 23 days $\Rightarrow + 10$ min
 - inactivity period ≤ 10 days $\Rightarrow + 10$ s maxi (ASM 142, 142 D, Graph D +, 122 D).

Technical characteristics A 800/801

- A screen informs the operator in the start-up process:

PLEASE WAIT
Storage days: 14
Delay (min:s): 08:47
ABORT? PRESS RESET



 Number of days since the last leak detector switching off
 Count down of the additional time

RESET

The operator can cancelled this additional time by pressing .

Starting up the leak detector

Before starting up the detector B 400.

- Connect the main power cable of the detector to the proper power outlet.
- Turn main power switch in the ON position ( B 210). The indicator lights on the control panel flash.
- If your leak detector is equipped with «control panel with graphic interface» option, please refer to the sheet  C 440 for the mode choice.

The following is shown on the LCD during 2 seconds.

As soon as the power is ON, the pumps start.

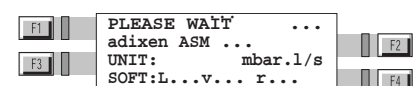

Audio messages inform the operator about starting-up process during this one.

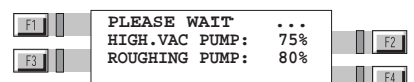

- If leak detector auto-calibration is ON \Rightarrow 1
- If leak detector auto-calibration is OFF \Rightarrow 2

If a printer is connected, a calibration ticket is automatically printed at the end of the calibration: examples  2 ,  4  B 320.

Starting up / Switching off the leak detector

Starting up of the leak detector (continued)

1

When the pumps have reached their nominal speed, the unit auto-calibrates: different screens will show.

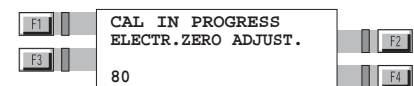

...

When calibration is completed, the unit is ready to start a cycle.

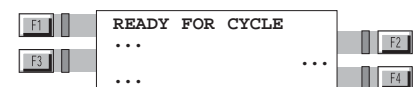

The digital voice gives to the operator the message: **“detector ready for cycle”**.

2

When the filament is OK, the unit is ready to start a cycle. A « i » is flashing at the right end of the 1st line of the LCD.

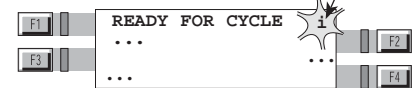

Flashing

It informs the operator that the unit is in manual calibration: it will remain in manual calibration until operator performs an auto-calibration.

Information message C 580

Internal calibration on request C 300

Note: It is possible to start a test cycle even if the detector is not calibrated.

Switching off the leak detector

The leak detector can be switched off at any time by depressing the main power switch to O (OFF). It is necessary to wait 1 minute after the leak detector switching off before moving it. It is also recommended (especially when the leak detector may not be used for an extended period of time) to stop if following the procedure described below.

Starting up / Switching off the leak detector

Recommended procedure

To protect the internal vacuum components of the leak detector against dust or any kind of contamination, it is recommended to keep its inlet blanked-off and under vacuum. Please proceed as follows before stopping the leak detector:

- Place the blank-off flange or close the test chamber.
- Start the test cycle.
- Wait until the leak detector reaches the more sensitive test mode. Make sure that the inlet vent is OFF.
- Stop the test cycle.
- Stop the leak detector.

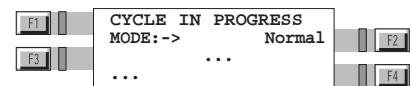

Inlet vent  C 500

How to use the leak detector: 2 methods

A help for control panel utilization/access.	
Operating principle of the control panel Access to parameters and parameters active depending on authorization	C 110
Setting and maintenance part presentation of the control panel Access to parameters and parameters active depending on authorization	C 120
Access to level 4 - Password	C 130
Summary of screens Complete displays list with access way and associated sheet	C 140

How to use your leak detector ?

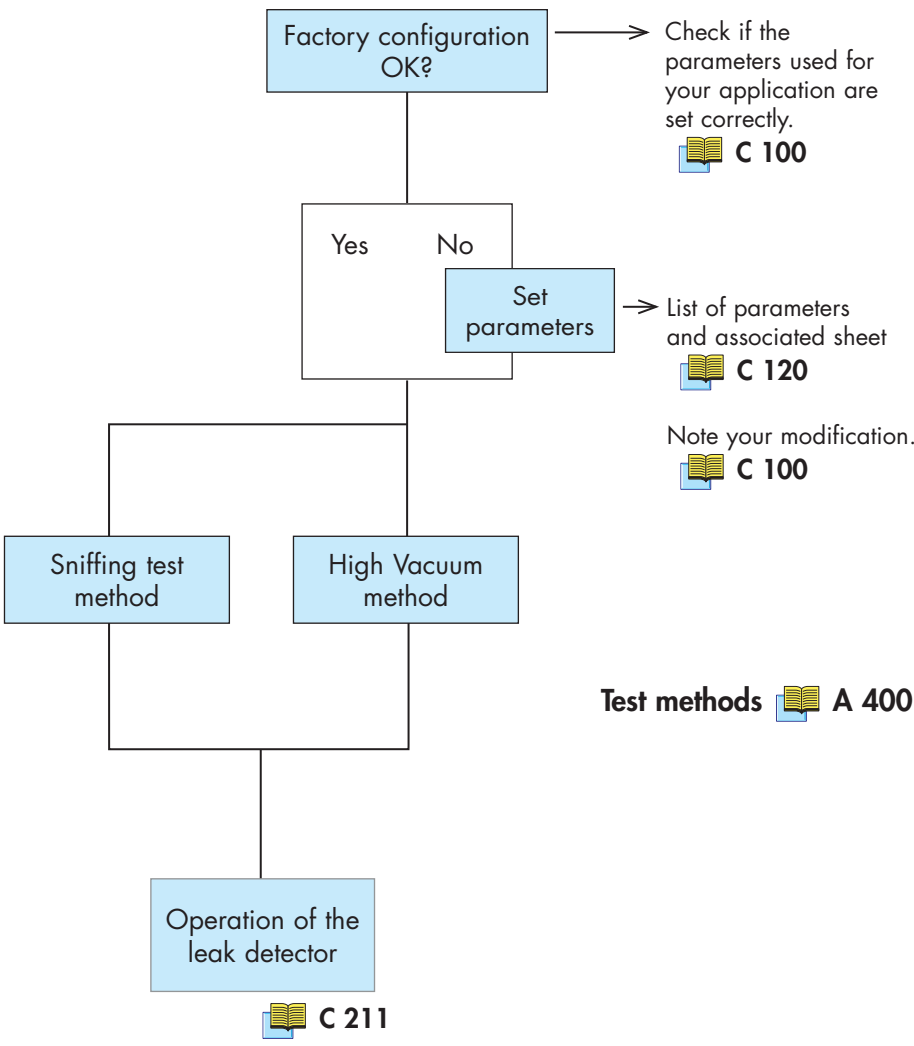

CB 01264 - Edition 06 - October 12

How to use the leak detector: 2 methods

Hard vacuum test method

- Hard vacuum test method offers 2 or 3 test modes: the Gross Leak, the Normal and the High Sensitivity mode. The leak detector will automatically go from the gross leak to the superior mode as soon as the inlet pressure has crossed the thresholds:

	Gross leak test mode	Normal test mode	High Sensitivity test mode
ASM 182 T	Inlet pressure < 6 mbar	----	Inlet pressure < 2×10^{-2} mbar
ASM 182 TD+	Inlet pressure < 6 mbar	----	Inlet pressure < 2×10^{-2} mbar
ASM 192 T	Inlet pressure < 6 mbar	----	Inlet pressure < 2×10^{-2} mbar
ASM 192 TD+	Inlet pressure < 6 mbar	----	Inlet pressure < 2×10^{-2} mbar
ASM 192 T2	Inlet pressure < 6 mbar	----	Inlet pressure < 2×10^{-2} mbar
ASM 192 T2D+	Inlet pressure < 30 mbar	Inlet pressure < 3 mbar	Inlet pressure < 2×10^{-2} mbar
ASM 142	Inlet pressure < 10 mbar	Inlet pressure < 5×10^{-1} mbar	----
ASM 142 D ASM Graph D+	Inlet pressure < 10 mbar	Inlet pressure < 5×10^{-1} mbar	----
ASM 122 D	Inlet pressure < 20 mbar	Inlet pressure < 2 mbar	Inlet pressure < 8×10^{-3} mbar

A hard vacuum test can be performed as soon as one of the test modes is reached.

Test mode selection

Factory configuration

Procedure

 C 100

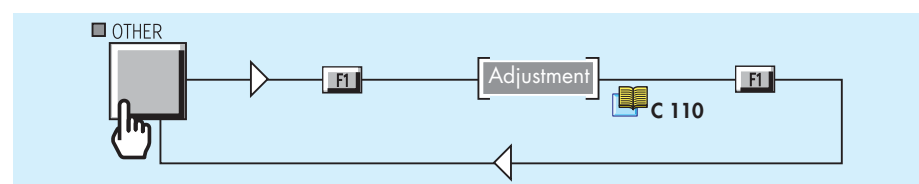

Notes

- The leak detector will switch test mode if the inlet pressure is under the normal test mode threshold.
- When the leak detector is in the selected test mode, a «->» sign is displayed on the screen.
- If the gross leak test mode is selected, the leak detector will remain in the gross leak test mode even if the inlet pressure is compatible with the normal test mode threshold.
- If the pressure is superior to 10^{-4} mbar, it's not possible to reach the normal or high sensitivity test mode  C 560.
- The leak detector measures a leak value which is displayed on the user interface.
- The test method used is the sniffer method.

Sniffing test method

Operation of the leak detector

Hard vacuum test

Make sure that parts can withstand the difference in internal / external pressure to which they are submitted.

Starting a test cycle

■ Connect the part or the installation to be tested to the inlet port of the leak detector or put the part in the test chamber.

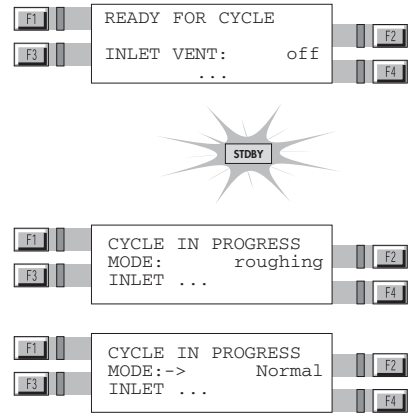
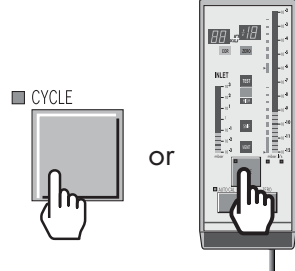

The leak detector reaches test mode selection. C 210

The leak value is displayed on the screen.

Leak value display

• On the operator interface:

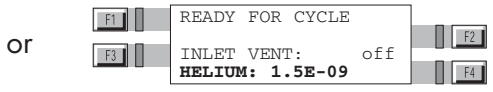
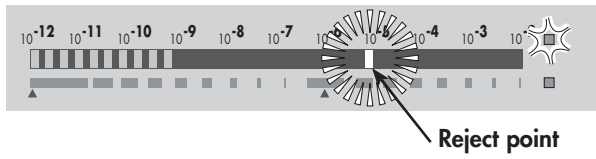

The helium signal zero scale displays the leak value in 2 colors following the measured leak value:

- the reject point is display with a red led.
- if the measured leak value exceeds the reject point, the flashed leds are red (and the blinking led orange).
- if the measured leak value is under the reject point, the flashed leds are green,

Operation of the leak detector

Leak value display • On the remote control:

Digital display



Analog display

When the bargraph zoom is ON, the leak value display is different. It shows 2 decades of signal as compare to the entire leak range when the bargraph zoom is off.

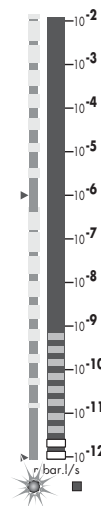

C 510

Ending a test cycle

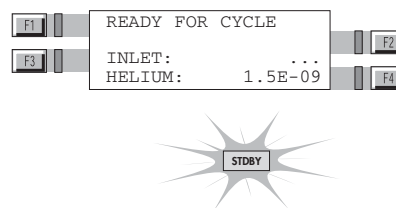
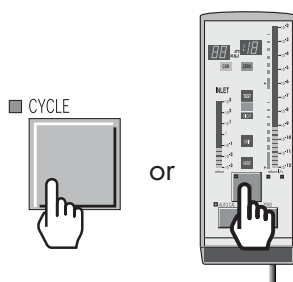

- In standby mode the user interface shows the leak detector helium background value.
- Note: If the cycle end function is activated, the test cycle end is different.

Cycle end function C 530

Ticket If memo function activated, and a printer connected to the leak detector, a result ticket is printed automatically:

example 6 B 320.

Venting the part or installation tested

- At the end of a test cycle, 2 possibilities are available:
- venting (inlet of the leak detector is back to atmospheric pressure)
 - not venting (keeping under vacuum) the part or tested installation tested remains under vacuum.

Inlet vent C 500

Operation of the leak detector

Sniffing test

Starting a sniffing test

While the leak detector is in stand-by mode, connect the sniffer probe (accessory to be purchased separately  **A 700**) to the sniffer port of the leak detector.

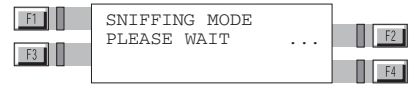
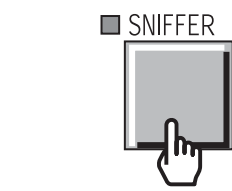
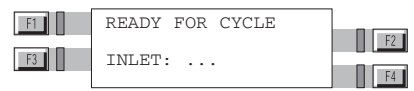

The sniffing mode message appears on the alphanumeric display. The sniffing test mode is operational.

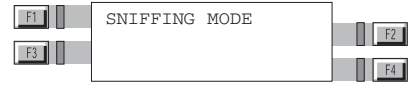

Leak value display

Displays are the same in hard vacuum and sniffing test modes. Please refer to hard vacuum test mode for the displays.

Ending a sniffing test

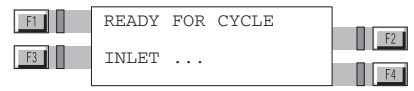

Sniffer probe clogged reject point

Accessories  **A 700**

Advice Block the sniffer probe end from time to time with a finger to check that the helium signal goes down. If not, the probe may be clogged.

Sniffer probe clogged  **G 400**

Operation of the leak detector

Purpose of the sniffer probe clogged reject point

When the helium signal is lower than the set «sniffer probe clogged» reject point, an information will be activated.

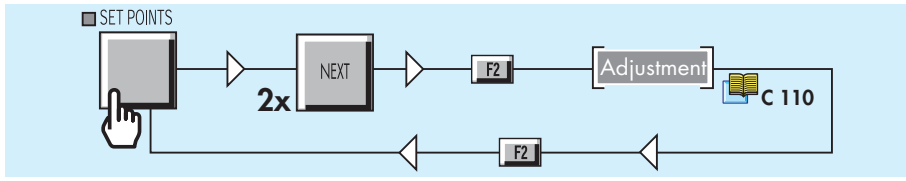

Adjust vacuum/sniffing alarm reject point

Note: Adjustment process is different depending on user interface level of the operator:

For operator with user interface **level 1** or **2**: access to level **4** with password.

To access to level **4** C 130

Procedure with user level 3

3

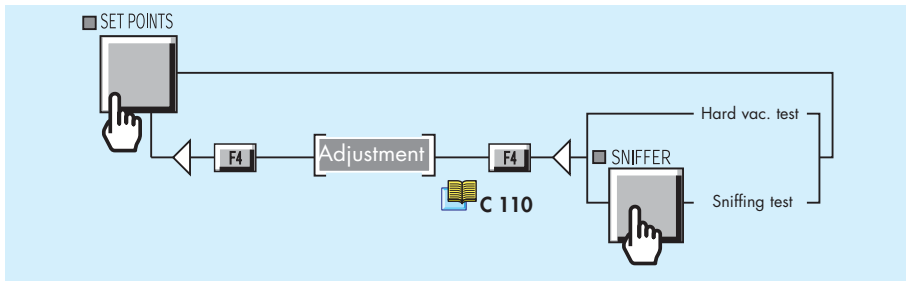

Procedure with user level 4

4

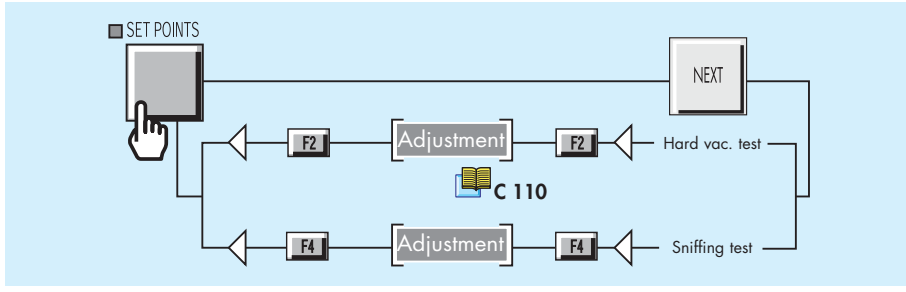

The unit selection of the leak detector is the threshold unit. If the operator would like to change unit, he must convert the threshold unit and reprogrammed it with the new one.

Calibration of the leak detector

Basic internal calibration of the leak detector see [C 301](#)

Advanced internal calibration of the leak detector see [C 302](#)

External calibration of the leak detector see [C 303](#)

Correction factor see [C 304](#)

Calibrated leak values programming see [C 305](#)

Adaptator for calibrated leak see [C 306](#)

Basic internal calibration of the leak detector

Purpose of the internal calibration

Check that the leak detector is correctly adjusted to detect the carrier gas selected and to display a correct leak value.
To calibrate the leak detector, a calibrated leak is used as a reference: the leak detector is equipped with an internal helium calibrated leak with reservoir and temperature compensation sensor.

The internal calibration could be:

- fully automatic if the operator uses the calibrated leak in the detector,
- semi-automatic if the operator uses an external calibrated leak.

When should an internal calibration be performed?

- When starting the leak detector in order to make sure that it is in proper operating condition.
- For high sensitivity test and optimized measurement accuracy: it is advised to let the internal temperature of the leak detector stabilize for about 30 min after start-up and then start a calibration.
- If in doubt regarding the proper operation of the leak detector (capability to properly detect a helium leakage). At any time, an internal calibration may be started.
- In case of intensive and continuous use: start an internal calibration at the beginning of each shift (8 hours of operation).

Internal calibrated leak

The internal calibrated leak is specifically designed to fit the present leak detector. It is composed of:

- a helium reservoir,
- a temperature sensor (used to take into account the effect of temperature on the leak rate),
- a built in membrane (to calibrate the helium leak rate),
- a special quick connection device,
- an identification label (similar to the identification label of an external calibrated leak).

It is delivered with a calibration certificate.

Calibrated leak location  F 700

Recalibration

It is recommended to have each calibrated leak recalibrated at regular intervals to validate its value.

Accessories  A 700

Basic internal calibration of the leak detector

Internal calibration with the internal He calibrated leak

The internal calibration can be:

- fully automatic:



The internal calibration is **automatically activated** during the start-up process of the leak detector. It does not require any operator action. The initial calibration during the start-up sequence allows the unit to be immediately operational.

- on operator request:

An internal calibration can be started by the operator **whenever the leak detector is not in test mode.**

If the detector has been calibrated with an external calibrated leak, the operator should store the values of the internal calibrated leak  **C 305.**

Tickets

If a printer is connected to the leak detector, a ticket is automatically printed at the end of the calibration: example  **2**  **B 320.**

Automatic internal calibration procedure

Note: Internal auto-calibration set ON,  **C 302.**

- Start the leak detector

Different screens appear during the calibration giving internal parameters values.

Audio messages inform the operator about internal calibration process during this one.

When calibration is complete, the unit is ready to start a cycle.

The digital voice gives to the operator the message

“Detector ready for cycle”.

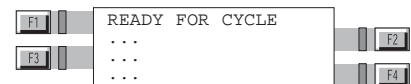

Note:

- It is possible to start a test cycle after a calibration failure: The operator should confirm the use of an uncalibrated leak detector.

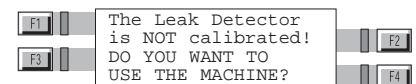

- The test is still possible but **“AL”** is displayed permanently (no value displayed). The bargraph is always available for the leak value reading.



- Until the autocalibration failure is resolved, the **“!”** is maintained on the standby screen.

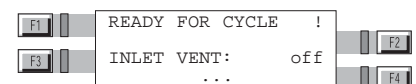

Basic internal calibration of the leak detector

On request internal calibration procedure

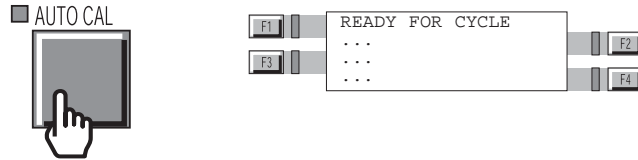

Then, the procedure is the same as for the automatic internal calibration.

On request calibration checking



Internal calibration with an external calibrated leak

It is semi-automatic because the operator must connect a calibrated leak to the inlet port of the detector.

- At the starting of the detector:
The calibration is not start even if the autocal is ON. The operator is informed that the calibration requests a calibrated leak connected to the inlet port of the detector.
- On operator request:
The operator can start a calibration **whenever the leak detector is not in test mode.**
Note: Internal calibration set ON.

Tickets

If a printer is connected to the leak detector, a ticket is automatically printed at the end of the calibration: example 3 B 320.

Procedure

- 1 Gas selection** In standard the gas used is the Helium 4. With the 3 masses option, the operator can use different gases: Helium 3, Helium 4 or Hydrogen.

3 masses option C 430

- 2 Calibrated leak parameters** The operator should program all the parameters of the used calibrated leak.

Position = external

Calibrated leak value C 305

Basic internal calibration of the leak detector

3 Start the calibration

- Place the external calibrated leak on the test port.
- Start the calibration.



4 Calibration preparation

These 2 screens appear alternately.

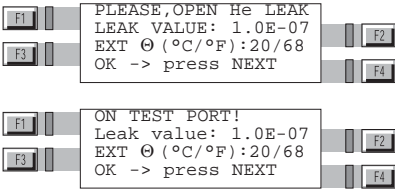

Note: If the operator press , all the parameter of the programmed calibrated leak are displayed.  **C 305**

Open the valve of the calibrated leak (if there is one).
Set the ambient temperature.



5 Validate the calibration process



Different screens appear during the process giving internal parameters values.

Basic internal calibration of the leak detector

6 End of the process

Close the valve of the calibrated leak (if there is one).

These 2 screens appear alternately.

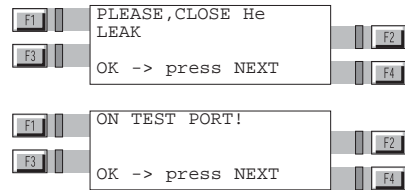

Validate the operation.



Note: If these operations are not done within a minute after these screens display, the calibration is automatically stopped. A message informs the operator of this stop.

When the calibration is complete, the unit is ready to start a cycle.

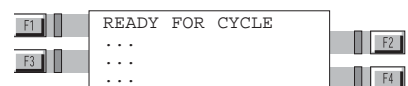

Note: it is possible to start a test cycle after a calibration failure.

Advanced internal calibration of the leak detector

A help for control panel utilization/access.

Operating principle of the control panel see C 110

Setting and maintenance part presentation of the control panel see C 120

Access to parameters and parameters active depending on authorization

Access to level 4 - Password see C 130

Summary of screens see C 140

Complete displays list with access way and associated sheet

Introduction The operator has the possibility to control on the internal calibration process:

- activation / deactivation of the internal calibration.
- setting of the checking function.

Activation/ deactivation of the internal calibration

For maintenance for example.

Procedure

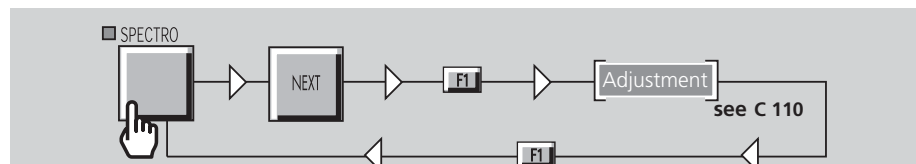

Notes:

- If the internal calibration is deactivated (off), it is still possible to start a test cycle and use the leak detector.
- When internal calibration function is activated (on), user could activate or not activate the checking function.

Advanced internal calibration of the leak detector

Checking function Internal calibration activated (on), checking function performs a calibration checking depending on set parameters. The calibration checking is performed with the internal calibrated leak of the leak detector (position parameter = internal) see C 305.

On request calibration checking At any time, the operator could perform a calibration checking with the internal calibrated leak.

Note: Leak detector in Stand-by.

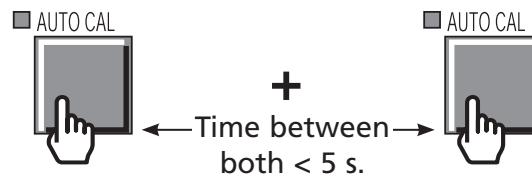

The leak detector compares the signal delivered by the internal calibrated leak to the internal calibrated leak parameters set:

- if the difference is lower than 15 %, the calibration of the leak detector is OK.
- if the difference is higher than 15 %, there is a warning message which requests to perform a complete calibration of the leak detector see C 301.

Parameters setting

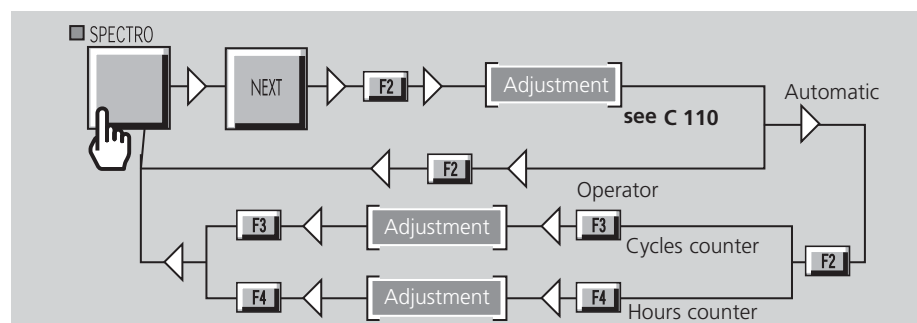

If checking function is automatic, operator should adjust cycles and hours counters which will trigger the automatic calibration checking.

Note: The first of the 2 counters reached will trigger the automatic checking.

Tickets If a printer is connected to the leak detector, a ticket is automatically printed at the end of the calibration:

example 5 see B 320.

Advanced internal calibration of the leak detector

Checking function with an external calibrated leak

It is possible to perform a calibration checking with an external calibrated leak (position parameter = external). But it is not automatic and in the case, the leak detector performs a complete calibration (not only a comparison like with the internal calibrated leak).

When the first of the 2 counters is reached, a "i" will flash at the right end of the 1st line of the LCD.

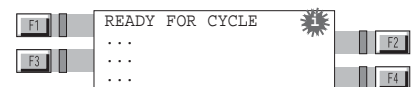

The "i" flashing will stay on the LCD until operator starts an external calibration see **C 303**.
An audio message advises the operator in the process to follow.

Note: It is still possible to start a test cycle even without performing an internal calibration .

On request calibration
checking

see C 301

External calibration of the leak detector

A help for control panel utilization/access.

Operating principle of the control panel



C 110

Setting and maintenance part presentation of the control panel

Access to parameters and parameters active depending on authorization



C 120

Access to level - Password



C 130

Summary of screens

Complete displays list with access way and associated sheet



C 140

Purpose of the external calibration

In some instances, it may be convenient to display a helium leak value so that matches a desired target value (typically the value of an external calibrated leak connected to the installation to test or at the inlet port of the leak detector).

ASM 1002: external calibration only in sniffing test.

- **In hard vacuum test mode**

When the measurement range is very different from the value of the internal calibrated leak.

- **In sniffing test mode**

When a specific calibration is required in the sniffing test mode to certify that the measurement is validated and accurated.

- **In hard vacuum or sniffing test mode**

When the leak detector is connected to an installation having its own pumping system in operation and a small amount of the leak goes into the leak detector. The external calibration allows to get a direct readout of the current leak value.

When the helium signal needs to be displayed in a different unit for convenience or to calibrate the leak detector if the internal calibrated leak is temporarily unavailable (manual auto-calibration selected).

The external calibration is provided for the operator to easily obtain a direct readout of the target value (or current external leak) thanks to a correction factor automatically calculated and applied to the digital display of the leak detector.

Note : For the ASI 22, the pressure measurement kit is necessary to do an external calibration ( **A 700**).

External calibration of the leak detector

External calibrated leak

An external calibrated leak (defined in accordance to your own requirements) is required for the external calibration procedure.

Accessories  A 700

Recalibration

It is recommended to have each calibrated leak recalibrated at regular intervals to validate its value.

Tables of preventive maintenance intervals  D 100

Digital and analog display

When the external calibration is performed, the digital display will show a corrected value. Then **COR** will come on to reflect it. The analog display in the remote control is not corrected and therefore both values might be different.

External calibration procedure

The external calibration should only be performed when the leak detector is already internally calibrated.

The external calibration procedure is performed in 2 steps:

- 1st step: selection of the test mode (hard vacuum or sniffing)
- 2nd step: adjustment of the target value: see below.

External calibration cancellation

At any time, the operator can cancel external calibration procedure.

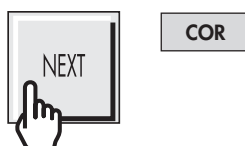

Procedure

Note: The external calibration should be performed in the test mode used by the operator: if the operator uses both test modes (hard vacuum and sniffing), he should perform one external calibration when he works in each test mode.

The external calibrated leak is connected to the inlet port of the leak detector or at a suitable location of the installation to test.

Réglage des paramètres de la fuite calibrée externe  C 305

External calibration of the leak detector

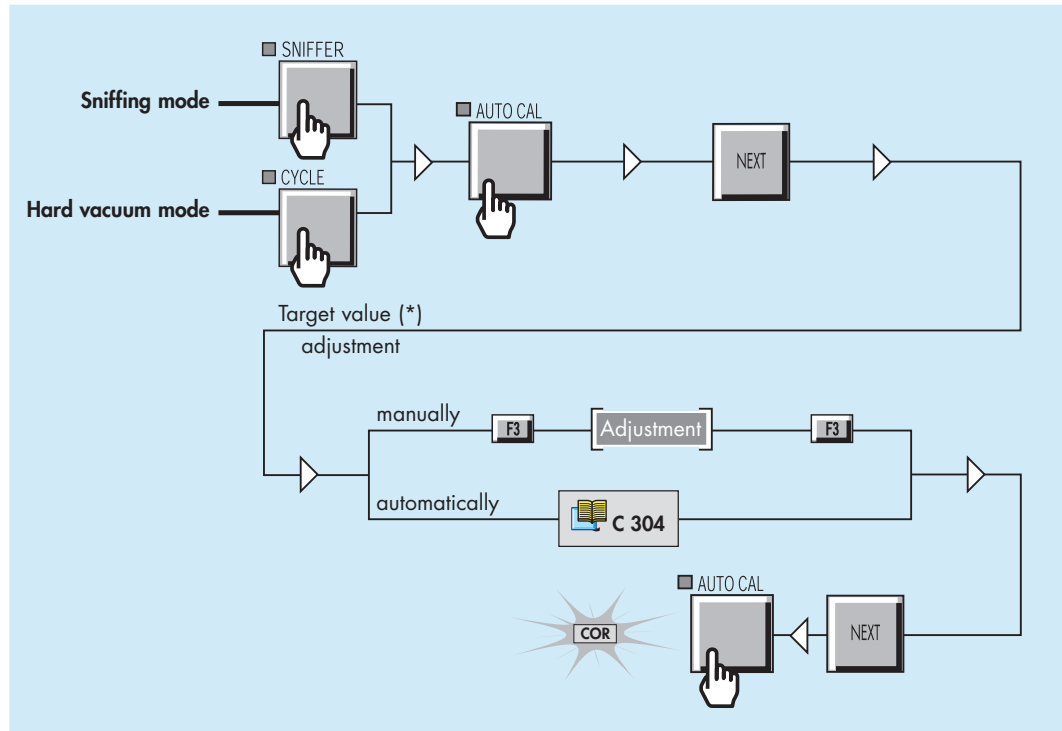

(*) The target value is the desired value to be displayed on the digital display at the end of the calibration..

The target value can be memorized following 2 methods:

- the operator enters directly the target value,
- the target value is automatically calculated by the leak detector.

About sniffing test mode

In sniffing test mode, the calibration can be performed with:

- the ambient atmosphere,
- an external calibrated leak,
- a container or installation, at atmospheric pressure, filled with a known gas mixture including Helium.



The sniffer probe will be exposed to one of the 3 items listed above (3rd one represents the most reliable and accurate way of calibrating a leak detector in sniffing mode).

The 1st and 2nd ones are the most common and practical methods.

Before using one of the 2 items, connect the sniffer probe to the sniffer port of the leak detector.

External calibration of the leak detector

Target value determination

- In hard vacuum test mode, 1 possible case:
 - The target value is the value of an external calibrated leak connected to the installation to test or at the inlet port of the leak detector.
 - **Case A**
- In sniffing test mode, 2 possible cases:
 - the target value is the value of an external calibrated leak.
 - **Case A**
 - If a container or installation is filled with a known gas mixture including Helium, it is possible to enter helium concentration as a target value. → **Case B**

Case A

When an external calibrated leak is used, it is recommended to take into account date of calibration and temperature effect for calculating the target value from the calibrated leak value as shown on its identification label.



HELIUM CALIBRATED LEAK
 Helium leak rate : 1.0×10^{-8} mbar.l/s at 20 °C
 Date of calibration : 10 Dec 2001
 % loss per year : 2 %
 % increase per °C : 3 %

Example of calibrated leak label indications (as listed here):
 If the date is 1st Dec 2003 (about 2 years after calibration) and calibrated leak (ambient) temperature is 25 °C:
 Target value = $1.0 \times 10^{-8} \times [1 + 0.03 \times (25 - 20)] \times [1 - (0.02 \times 2)]$
 = 1.1×10^{-8} mbar.l/s

Case B

Reminder: 1 PPM = 1.0×10^{-6} (concentration)

Example : container with 100 PPM helium mixture.

2 possibilities :

- enter target value = 0 E+02 to display the test result in PPM
- enter target value = 1.0 E-04 to display the test result in helium concentration
 (100 PPM = $100 \times 10^{-6} = 1 \times 10^{-4}$)

Checking function with an external calibrated leak

Correction factor

A help for control panel utilization/access.

Operating principle of the control panel	see C 110	Access to level ④ - Password	see C 130
Setting and maintenance part presentation of the control panel	see C 120	Summary of screens	see C 140
Access to parameters and parameters active depending on authorization		Complete displays list with access way and associated sheet	

Definition The correction factor is used to display the helium signal (changing unit for example).

The correction factors applied to the digital display with respect to the external calibration are:

- VACUUM COR in gross leak test mode,
- SNIF COR in sniffing test mode.

The VACUUM/SNIF COR values are automatically adjusted according to helium signal fluctuations.

These correction factors are memorized until another external calibration is validated.

They can be activated, deactivated or modified.

The correction factors are automatically calculated by the external calibration but it is also possible to enter them manually see C 303.

Activate/Deactivate the correction factor VACUUM/SNIF COR Adjustment

There are 2 possible procedures depending on which authorized level: level ③ and ④.

Procedure with user level ③

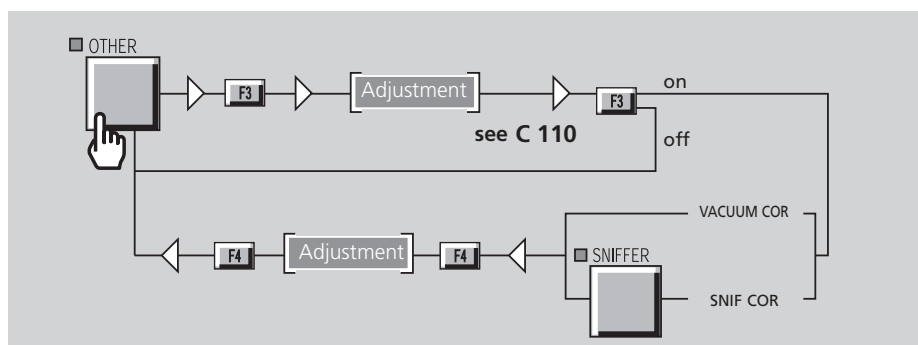

Correction factor

Procedure with user level

4

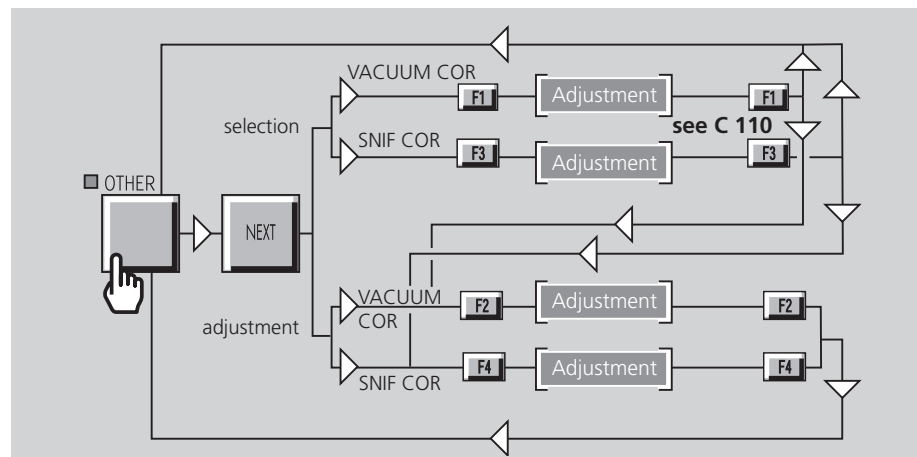

General notes (in vacuum or sniffing test mode)

- During the external calibration process:

$$\text{basic digital display} \times \text{VACUUM/SNIF COR} = \text{target value}$$

Basic digital display is the helium signal basic display without correction ratio (as if COR indicator is OFF or VACUUM/SNIF COR equal to 1.00E-00).

- Once the external calibration correction is validated, the digital display is modified:

$$\text{corrected digital display} = \text{basic digital display} \times \text{VACUUM/SNIF COR}$$

The analog display (standard scale) always displays the basic value of the helium signal which is not modified by VACUUM/SNIF COR.

- During the last step of the external calibration, the VACUUM/SNIF COR is displayed and automatically calculated with respect to the fixed target value and the present basic signal value.

The VACUUM/SNIF COR ratio is fixed and memorized when the AUTOCAL key is pressed to confirm the CORRECTION and stop the external calibration process.

- The COR indicator is ON as soon as the VACUUM/SNIF COR is ON and different from 1.00E-00.

If the target value is the same value as the standard signal on the digital display, in other word if VACUUM/SNIF COR is equal to 1.00E+00, the COR indicator is automatically OFF: the external calibration is OFF.

- If RESET is pressed during or at the last step of the external calibration process, the leak detector comes back to the previous digital display status which was effective before the external calibration request and VACUUM/SNIF COR is not changed.

Calibrated leak values programming

A help for control panel utilization/access.

Operating principle of the control panel



C 110

Setting and maintenance part presentation of the control panel



C 120

Access to parameters and parameters active depending on authorization

Access to level  - Password



C 130

Summary of screens



C 140

Complete displays list with access way and associated sheet

Different types of calibrated leaks

Before to start an internal calibration of the leak detector (with internal or external calibrated leak), the parameters of the calibrated leak used should be programmed by the operator.

The leak detector can be calibrated:

- with an internal or external calibrated leak
- with different gases (Hydrogen and Helium 3) if it is equipped with the 3 masses option.

3 masses option  C 430

Gas	Internal calibration	External calibration
Helium 4	X	X
Helium 3	-	X
Hydrogen	-	X

Whatever the type of calibrated leak used, the parameters to program are the same.

Calibrated leak values programming

Programming the calibrated leak parameters

This operation can be made with the data written on the calibrated leak identification label or the calibration certificate delivered with it. Example of identification label:

HELIUM CALIBRATED LEAK
 Helium leak rate : 1.0×10^{-8} mbar.l/s at 20 °C
 Date of calibration : 10 Dec 2001
 % loss per year : 2 %
 % increase per °C : 3 %

Note: At each time the operator modify the "Location" parameter, he should also re-adjust all the parameters (if necessary).

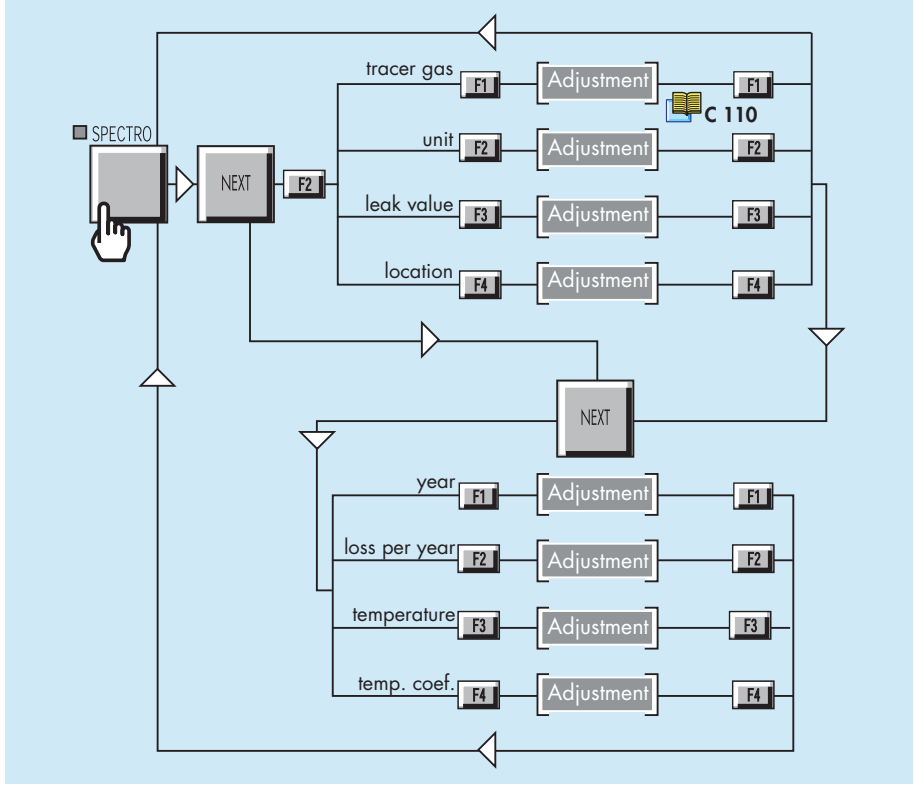

Leak location selection

Note: The "Location" parameter (internal or external) concerned the location of the calibrated leak used for the calibration and not the type of calibration.

Adaptor for calibrated leak in sniffing mode

An adaptor DN 16 or DN 25 for calibrated leak has been designed for the calibration of the detector with an external calibrated leak.

Accessories  A 700



How to use the adaptor ?

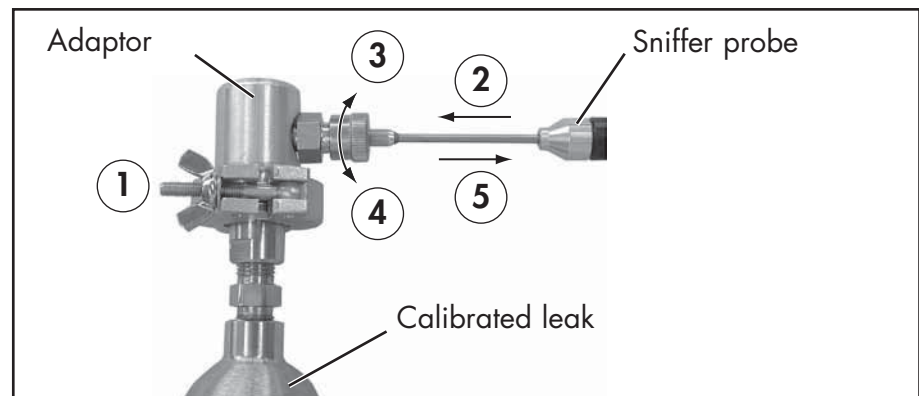

- 1 Place the adaptor to your calibrated leak used for the calibration.

Start a calibration

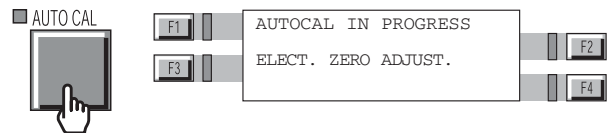

- 2 Place the sniffer probe in the calibration port.

- 3 Tighten the fixing screw. Follow the auto-calibration.

Calibration of the leak detector  C 300

- 4 Untighten the fixing screw.

- 5 Remove the sniffer probe of the calibration port. Follow the auto-calibration.

Notes

- Waiting 10 s (mini) for the signal stabilization before reading of the leak value.

- The leak value displayed on the LCD consider the He of the air.

Example : calibration with a leak of 2×10^{-5} mbar.l/s

The value displayed is:

$$2 \times 10^{-5} + 5 \times 10^{-6} = 2.5 \times 10^{-5} \text{ mbar.l/s}$$

Remote control



The remote control is an accessory, but it could be also an option depending on the helium leak detector model.

The remote control is equipped with a magnet allowing the operator to place it on a metallic surface. The operator can read the helium signal and has access to control keys such as cycle command autocalibration and auto-zero.

Remote control interface

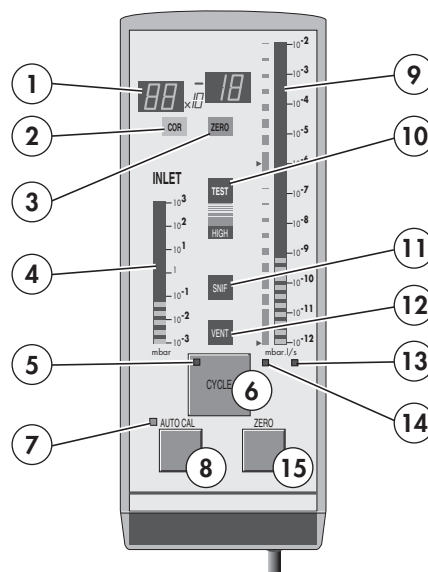

1	Helium Signal digital display
2	Correction factor COR indicator
3	Zero function indicator
4	Inlet port pressure analog display
5	Test cycle ON indicator (ON when activated)
6	Cycle Start/Stop control key
7	Calibration in progress indicator
8	Auto-calibration start control key
9	Helium signal analogic display
10	Test ON indicator
11	Sniffing test mode ON indicator
12	Inlet VENT ON indicator
13	Helium signal standard scale ON indicator
14	Helium signal Zero scale ON indicator
15	Zero ON/OFF control key

Remote control

Remote control connecting

In order to use the remote control with control panel with graphic interface, it is necessary to connect the remote control before starting up the detector.

Location and connecting  B 210

Remote control choice

3 different units could be selected in the leak detector but only one unit is available on the remote control. So the operator should choice its remote control in accordance of the operation unit chosen.

Unit  C 570

Accessories  A 700

When the operator connects the remote control on the leak detector, the leak detector unit is automatically reprogrammed with the unit of the remote control. The remote control unit is memorized by the detector when the operator disconnects the remote control.

Use and display

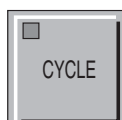

The remote control:

- allows to display leak measured value,
- allows to start/stop cycle, zero function and internal calibration,
- allows to display status of the air inlet vent, sniffing test mode and external calibration,
- doesn't allow to adjust leak detector parameters.

Analog and digital displays

On remote control and control panel, the displayed values on the analog and digital displays are exactly the same.

Operation of the leak detector  C 211

To start/stop a cycle

In order to start/stop a cycle, operator can use either the CYCLE control key on the control panel or remote control.

Display

The LED indicator is ON/OFF when the control key is activated/deactivated.

As soon as the detector is in test, the TEST indicator is ON.

Remote control

Use and display (ctd)

Zero function

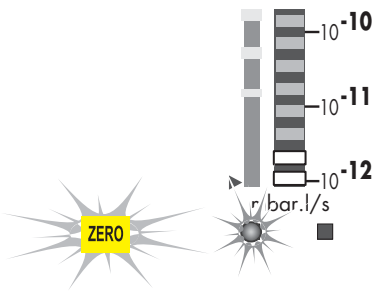

In order to start zero function, operator can use either the ZERO control key on the control panel or remote control.

Display

Two indicators are ON when the zero function is activated:

- the ZERO indicator,
- the zero scale indicator.

Zero function C 540

Internal calibration



In order to start an internal calibration, operator can use either the AUTOCAL control key on the control panel or remote control.

Display

The LED indicator is ON when the control key is activated.

The LED indicator is OFF at the end of the calibration procedure.

Calibration of the leak detector C 300

Inlet vent Sniffing test mode



For these 2 functions, the remote control displays only their status: use the control panel in order to activate/deactivate them..

Display

The LED indicator is ON/OFF when the function is activated/deactivated.

Inlet vent C 500

Sniffing test mode C 211

External calibration



The remote control displays only its status: use the control panel in order to start/stop it.

Display

The LED indicator is blinking when the external calibration is activated.

At the end of the calibration procedure, the LED indicator is OFF and the correction factor COR is ON.

External calibration C 303

Headphone and loudspeaker

The operator can connect a headphone or an external loudspeaker to the detector through the printer sub D 9 pins, (J1).

Location and connecting  B 210

Level adjustment

The audio levels for the headphone or the external loudspeaker are the same as for the audio alarm and digital voice functions. In order to adjust the headphone or the external loudspeaker audio levels, you must adjust the levels of the audio alarm and digital voice functions.

Audio alarm / Digital voice  C 520

Accessories

Headphone

You should use the headphone connector accessory:

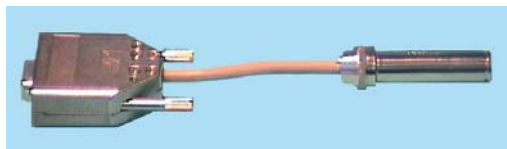

Sub D 9 pins

Jack plug 6.35 mm mono

Accessories  A 700

The manufacturer does not supply the headphones. The specifications are:

- Impedance: 400/500 Ω
- Jack plug 6.35 mm (or other sizes with adaptor)
- Frequency band: 18 Hz to 20000 Hz

External loudspeaker

The manufacturer does not supply an external loudspeaker. The external loudspeaker has the same characteristics as the internal loudspeaker:

- Impedance: 8 Ω
- Power: 8 W

Headphone and loudspeaker

Configuration

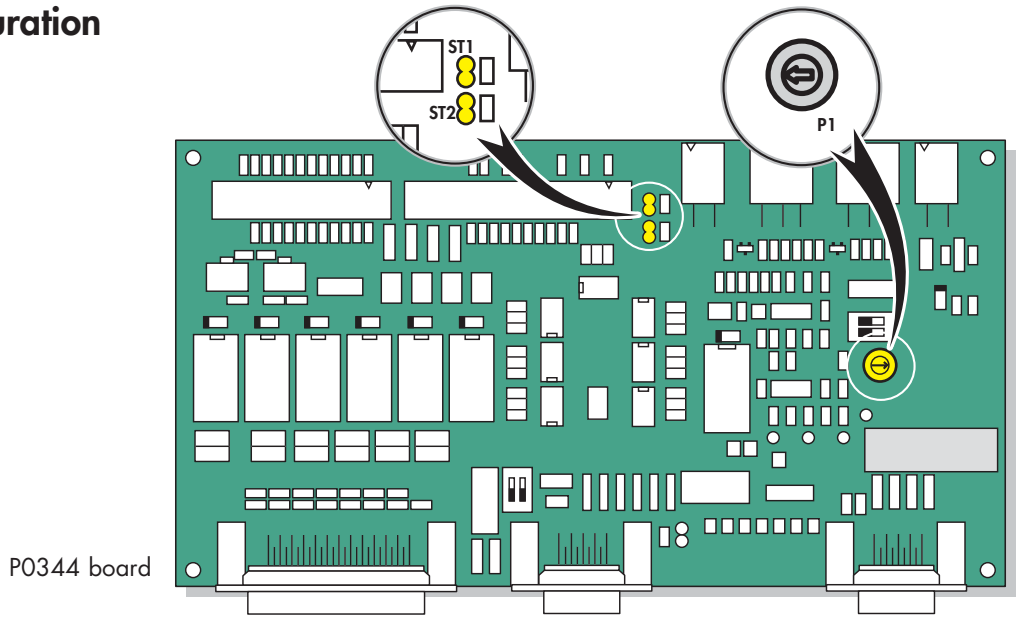

P0344 board localization F 400

- The operator can adjust the headphone audio level with P1 or with panel control (+ and -).

	P0344 board	Strap on ST1/ST2	Sub D 9 pins (printer plug)
Int	Internal loudspeaker active	<input type="checkbox"/> ST1 • ST2	No plug connected
Int		• ST1 <input type="checkbox"/> ST2	
Int	Internal loudspeaker active + headphone connected	<input type="checkbox"/> ST1 • ST2	
Int		• ST1 <input type="checkbox"/> ST2	
Int	Internal loudspeaker not active + headphone connected	• ST1 <input type="checkbox"/> ST2	
Ext		<input type="checkbox"/> ST1 • ST2	
Int	Internal loudspeaker not active + External loudspeaker connected	• ST1 <input type="checkbox"/> ST2	
Ext		• ST1 <input type="checkbox"/> ST2	

3 masses option

Purpose Leak detection is used to detect micro-openings, porosities, etc. in test parts. The detection of these passages involves the use of a light gas, which is capable of infiltrating the smallest passages quickly. The standard gas used is the Helium 4 but the operator has the possibility with the 3 masses option to use another gases: Hydrogen or Helium 3.

Background is much higher in H₂.

The unit equipped with the 3 masses option does not have any external differences in relation to the standard unit. The modifications are inside the unit (analysis cell magnet and electronic supervisor board).

- Typical background values, in cycle, detector on itself:
- At start ± low range 10⁻⁵ mbar.l/s.
 - After 2 or 3 hours ± low range 10⁻⁶ mbar.l/s.

The 3 masses option purpose, used with Hydrogen, is the leak research only and not the continuous analysis of the hydrogen concentration of a gas. The leak detector is not adapted for a hydrogen concentration continuous analysis. The leak detector use in such conditions, as well as the hydrogen concentration of the gas used, are under the supervision of the user.

The functions are the same as the standard detector.

Gas selection

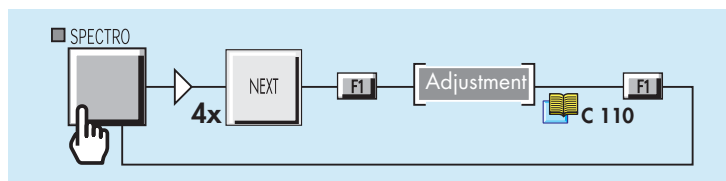

Calibration in Hydrogen or Helium 3

The leak detector can be calibrated in Hydrogen or Helium 3 with an external calibrated leak connected to the leak detector inlet.

Procedure

- Connect an Hydrogen or Helium 3 calibrated leak at the inlet of the leak detector.
- The operator should adjust the parameters of the calibrated leak used.

Calibrated leak values programming C 305

Calibration of the leak detector C 300

Control panel with graphic interface

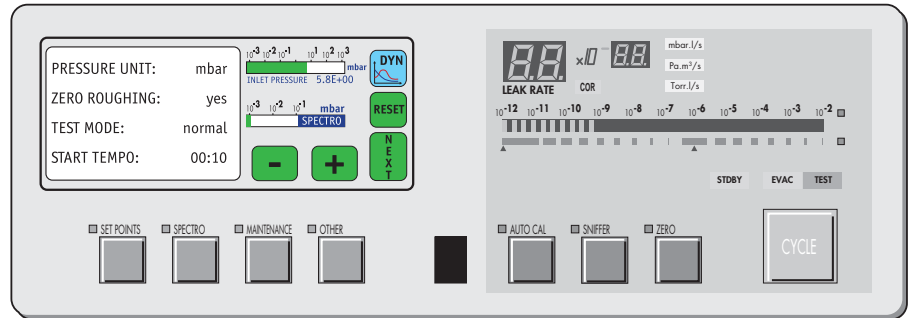

The control panel with graphic interface is equipped with a color touch. In addition to standard panel function, it shows different graphics. This display is offered as an option or as an accessory.

 **A 600/700**

Graphic interface purpose

To display, measure and record the leak detector Helium signal as well as the inlet pressure.

Leak detector software version

It requires a leak detector software version $\geq V3.0r01$ ($\geq V1.0r06$ for ASI 22). Refer to "At the leak detector starting up" paragraph.

Automatic standby screen

If no action is registered through the color touch screen for a period of 1 hour, a standby-screen (black screen) appears automatically. Any press on any key will reactivate the display.

Use caution

- Use a pen, a finger or any other object with a rounded shape on the touch screen.
Don't use a pointed object (screwdriver for example).
- Storage temperature and humidity level.

 **A 800/801**

Control panel with graphic interface

Control panel interface

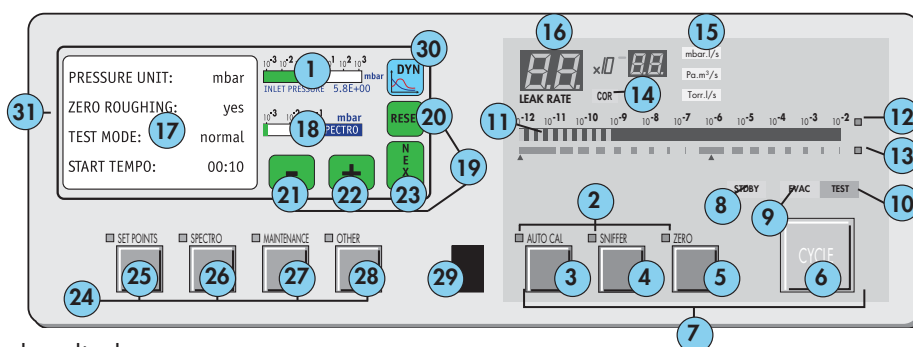

- 1 Inlet port pressure analog display
- 2 Control and menu selection indicators (ON when activated)
- 3 Auto-calibration START/ABORT control key
- 4 Sniffing mode ON/OFF control key
- 5 Auto-zero ON/OFF control key
- 6 Cycle START/STOP control key
- 7 Control keys (4 keys)
- 8 Standby ON/OFF indicator
- 9 Evacuation ON/OFF indicator
- 10 Test ON/OFF indicator
- 11 Helium signal analogic display
- 12 Helium signal analogic scale ON/OFF indicator
- 13 Helium signal Zero scale ON/OFF indicator
- 14 Correction factor COR indicator (applied to digital display)
- 15 Units of measurement selection
- 16 Helium signal digital display
- 17 Menu display (4 lines)
- 18 Spectro pressure analog display
- 19 Modification access keys (4 keys)
- 20 RESET: next display/parameter circular function
- 21 22 Plus or minus value adjustment, parameter selection, audio volume adjustment keys
- 23 NEXT of previously displayed values (cancels temporary inputs)
- 24 Menu selection access keys (4 keys)
- 25 SET POINT menu selection key
- 26 SPECTRO (calibration and analyzer cell configuration menu selection key)
- 27 MAINTENANCE menu selection key
- 28 OTHER menus selection key (test mode selection, inlet VENT selection, date/time)
- 29 Remote control connection (accessory)
- 30 Graphic interface selection key
- 31 Color touch screen

Control panel with graphic interface

Change of interface "Basic" mode

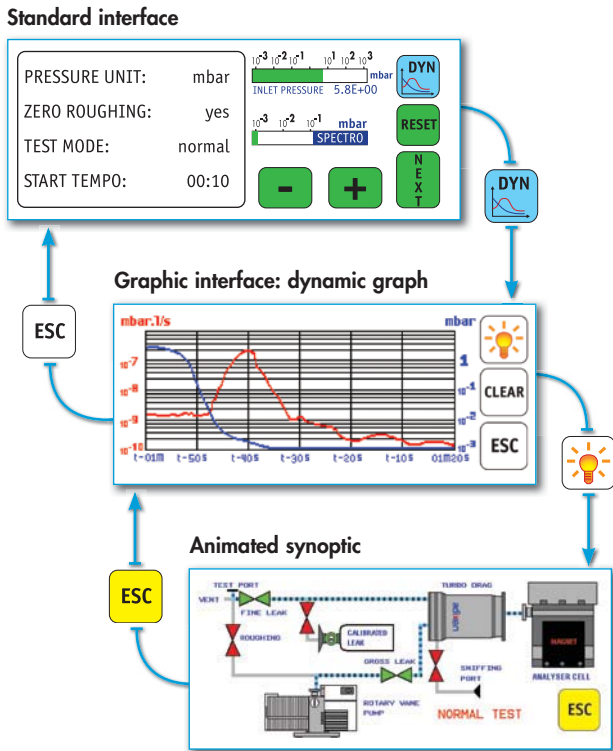

"Advanced" mode

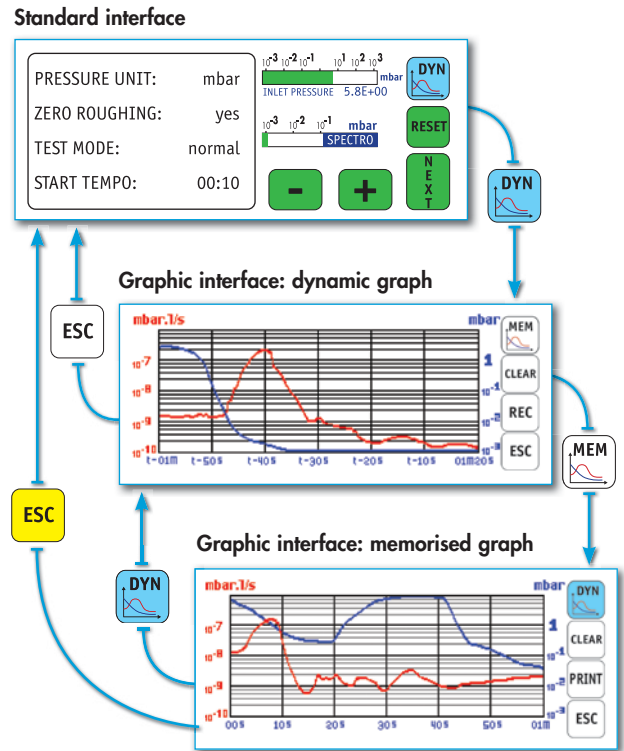

Notes:

- Any action on one of the following keys switches the display back to standard.



- After repeated zooms or measures in a memorized graph, some display defects could appear when you return to the dynamic graph.

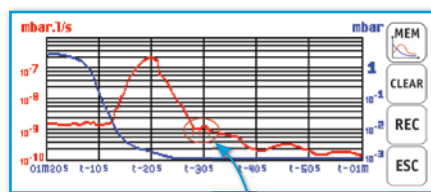

defect example

These defects are unpredictable and no consequence. If a graph is recording, these defects will not be recorded.

Control panel with graphic interface

Operating principle of the standard interface

Please refer to the operating principle of the standard control panel.



Operating principle of the graphic interface

The graphic interface offers 2 operating ("basic" and "advanced") modes.

Dynamic graph

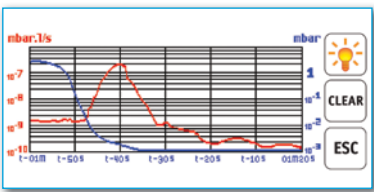

Memorized graph

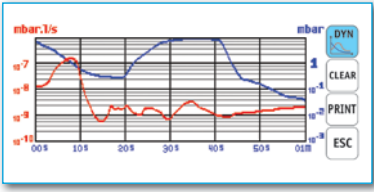

Animated synoptic

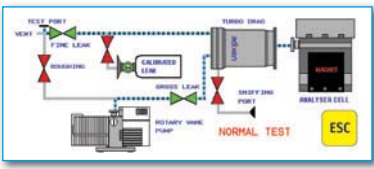

Fonction	"Basic" mode	"Advanced" mode
<ul style="list-style-type: none"> Dynamic graph It shows the helium signal, inlet pressure and reject threshold curves, for a period between 30 s and 4 h, depending on set parameters. It appears by default when we switch from the standard interface to the graphic interface. 	X	X
<ul style="list-style-type: none"> Memorized graph It allows to show the historical of the memorized helium signal, inlet pressure and reject threshold curves, for a period between 3 h 16 mn and 900 h, depending on set parameters. It allows to zoom in on the curves and to measure the signals. 	-	X
<ul style="list-style-type: none"> Vacuum diagram It allows to show the operating principle of the leak detector, its components and the leak detector active parts during the different test phases. The valve colour corresponds at the status (opened / closed) of this valve when the detector is in vacuum test, sniffing test, stand-by or autocalibration. If a valve is manually activated, it will not change of colour on display. 	X	-

Control panel with graphic interface

Selection of the graphic interface use mode

At the leak detector start up

When we switch on the leak detector, the starting screen displays the selected mode.

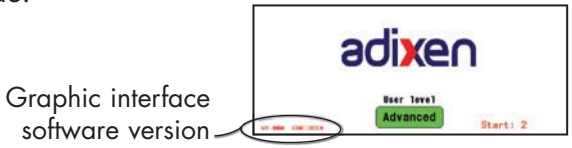

The operator has 6 seconds to change it with a simple press on the key **ADVANCED** or **BASIC**.

During the leak detector use

In order to return to the starting screen, press the following keys at the same time:

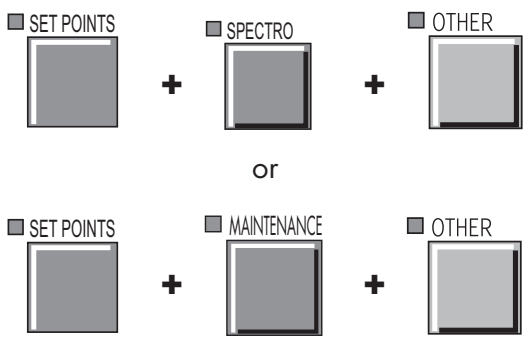

These operations are equivalent to do a complete reset : the dynamic and memorized graphs will be erased.

Control panel with graphic interface

Graphic interface description

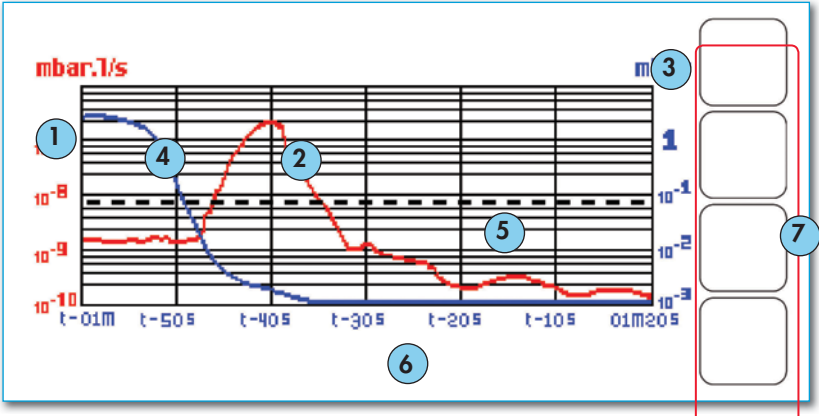

- ① Helium signal scale
- ② Helium signal (red curve)
- ③ Inlet pressure scale
- ④ Inlet pressure (blue curve)
- ⑤ Reject threshold (black curve)
- ⑥ Time scale
- ⑦ Selection keys: see details below

Selection keys

- Access to the memorized graph display
- Access to the dynamic graph display
- Start recording a graph
- Stop recording a graph
- Return to the previous screen or the standard interface
- Exact value display for a selected point
- Zoom on the selected area
- Helium signal curve selection
- Inlet pressure curve selection
- Target moving
- Deletion of the curve displayed on the screen
A message is displayed in order to confirm the operation.
- Memorized graph recording
- Access to the leak detector vacuum diagram
- Contrast adjustment

Control panel with graphic interface

Graphic interface setting

A simple press on the dynamic graph allows access to the setting menu.

Menus description

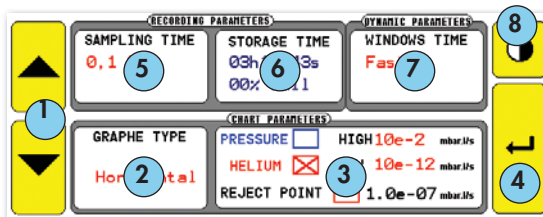

"Advanced" mode

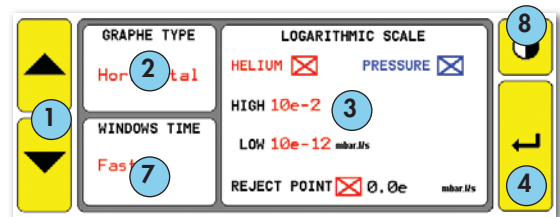

"Basic" mode

- 1 Selected parameter modification
 - 2 Graph type selection : vertical or horizontal
 - Time precision required >horizontal
 - Measure precision and speed required >vertical
 - If we switch from a vertical graph to a horizontal graph, or vice-versa, all the dynamic graph points will be erased.
- example: the same curve with both graph types.

Horizontal

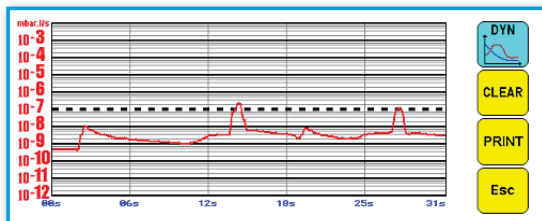

Vertical

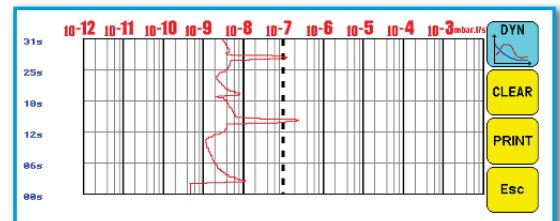

Control panel with graphic interface

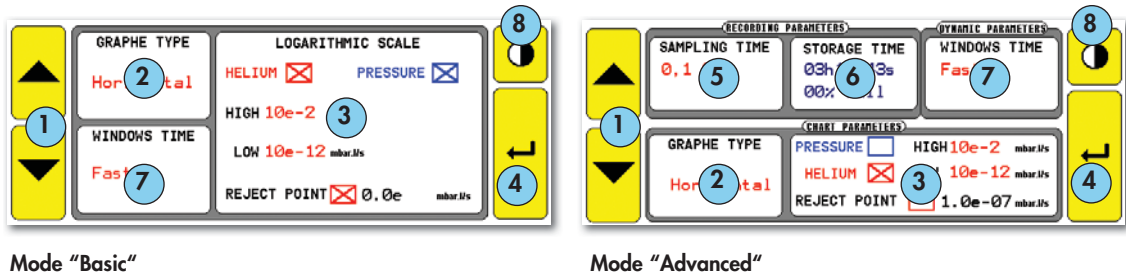

- 3 • Curves to show/recorder selection with a simple press on the square: inlet pressure (PRESSURE), helium signal (HELIUM) and reject threshold (REJECT POINT).
 - The reject threshold and the unit of measurements in this menu can also be adjusted in the SET POINTS and OTHER menus. Any modification will be applied to the 3 menus (SET POINT, OTHER and graphic interface).
- Display area setting of the inlet pressure and helium signal curves.
 - If only one curve is selected, the display area applies to this curve.
 - If the both are selected, the display area applies to the helium signal : the inlet pressure display area will be automatically 5 decades higher than the helium signal display area.
- 4 Modification validation or return to the graph.
- 5 Sampling rate between 2 measurements = 2 consecutive points of the memorized curve.
- 6 Maximum recording time possible according to the sampling time set for the memorized graph.
- 7 Time window displayed for the dynamic graph.
 - "fast" represents the maximum signal scrolling speed.
- 8 Adjustment of the contrast.

Contrast adjustment

From the setting menu, you can adjust the screen contrast. Optimum brightness after 5mn switch on. This panel is delivered with an optimum setting of the brightness.

Note: The screen lifetime is the best with a contrast adjusted to 50 %.

- Press on the contrast key 8
- Adjust the contrast with the ▲ and ▼ keys 1
- Validate the modifications OK

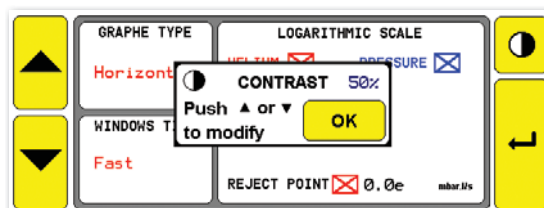

Control panel with graphic interface

Memorized graph

Recording

Dynamic graph on the screen

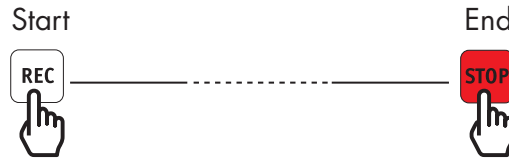

The recording time is displayed at the bottom left of the screen.

The red key **STOP** is displayed as soon as a recording is in process.

Notes:

- If the memory is not erased between 2 recordings (**CLEAR**) all the successive recordings are on the same memorized graph. A cursor indicates the end of each recording. A cursor indicates the end of each recording.

example:

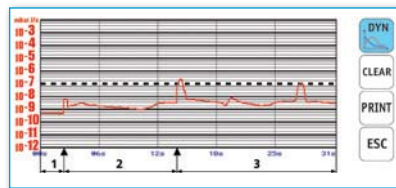

3 recordings on a same memorized graph

- When the memory is full and a recording is in process, the recording is automatically stopped and the following message displayed:

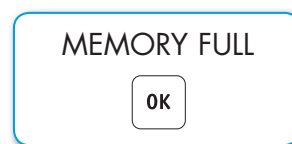

- It is possible during a recording to show or to enlarge the curve portions already memorized, without stopping it. To do this, press **MEM**



Similarly, it is possible to use all the control panel functions : menu access, start a cycle, auto-calibration, ...

Note: In the case of an auto-calibration with an external leak, set the standard interface in order to follow in the screen the instructions given by the leak detector.

- Recording continues until we press **STOP** .

Every leak detector stop or control panel disconnection will erase the memory. Save the memorized graph (if required) before these operations.

Control panel with graphic interface

Display Reach the memorized graph by tapping on the  key.

Note:

- You can go to the memorized graph as soon as you have recorded at least 2 points.
If no recording has been done, the following message displays:

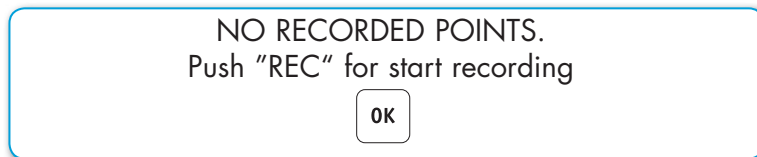

Zoom The memorized graph allows you to enlarge curve areas. You only should define the targeted area with 2 point:

- Zoom in: with your finger or a pen, tap on the screen to set point **1**, and **2**, and tap on the  **3** key.

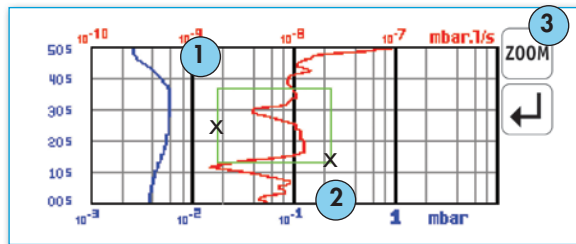

- Zoom in: with your finger or a pen, tap on the screen to set point **1**, and **2**, and tap on the  **3** key.

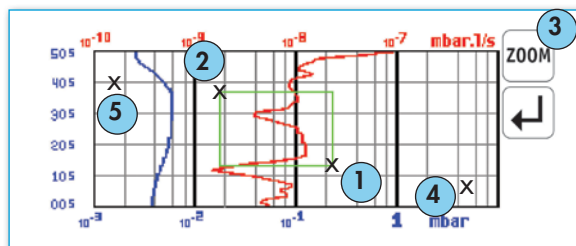

- To return to the previous zoom out, set points **1** and **2** nearby (maximum 40 zooms out could be memorized).
- To return to the original graph (complete zoom out), put the points **4** and **5** very distant.

Notes:

- After having defined the targeted area, and before pressing , it is possible to modify the targeted area: move the area sides or angles with the finger.

Control panel with graphic interface

- You can enlarge as many times as you want until the displayed period is equal to the sampling time set (until 2 points visible on the graph).
- You can only enlarge the complete decades: you can not enlarge inside a decade.

Point measure The memorized graph allows you to give the exact measure of every memorized graph point at a "t" time.

- Press on **MEAS** key **1**.

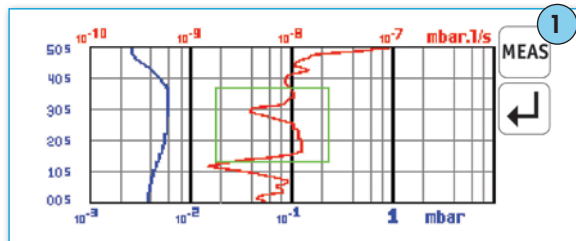

- A target **2** appears at the screen center.

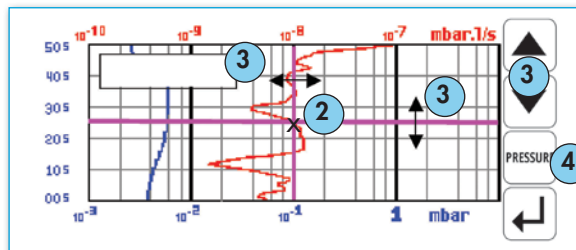

The target is the curve point to measure.

It is possible to change the target: move the axes with the finger or arrows **3**.

- To switch the target from the helium signal curve to the inlet pressure curve, press the key **4**.

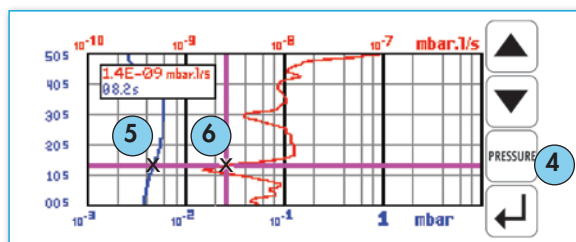

1.4E-09 mbar.l/s → helium signal value **6** or inlet pressure **5**
08.2 s → measure time (t)/recording start

Control panel with graphic interface

Memorized graphs saving

It is possible to do a screen copy (.bmp) or to create a file (.txt) with the measures memorized. The .txt file is compatible with Excel: the separator by default is "tab".

Notes:

- The .txt and .bmp files saved correspond to the curve points displayed on the screen:
 - To have all the points, it is essential to be on the original graph (no zoom).
 - If a zoom has been done before the saving, the saving corresponds only to the curve points displayed in the selected area.
- If the memorized graph is made up of several successive recordings:
 - the "▶" cursor will indicate each change of recording on the .bmp file.
 - "break down n°" message will be indicated at the end of the last line of each recording.
- If you press  key while the remote control is connected to the leak detector, the leak detector will be out of order.

To remedy it, press  and disconnect/reconnect the remote control.

Material

- A specific cable to connect the control panel with the PC.
Part number: **A461946**
 - Delivered with all the leak detectors equipped of the "control panel with graphic interface" option.
 - Not included in the "control panel with graphic interface" accessory.
 - A specific software "ASM Downloader" should be set in your PC download it:
 - either on our internet www.pfeiffer-vacuum.com
 - or from the sheet  **G 800**.
 - PC configuration:
 - PC 300 MHz, 128 Mb RAM, 50 Mb hard drive, Graphic card 800 x 600 x 256 colors.
 - Windows 98, Windows 2000, Windows XP
- Display the memorized graph to the screen.

Control panel with graphic interface

Procedure On the control panel, start the saving



Connect the cable



Don't try to execute the software as long as this screen is not displayed.

On the PC, execute the specific software

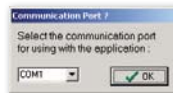

ASM Downloader 1.1.1

Screen Copy Record File Comment Test n°12

Save Screen Copy to BMP Downloading Ok 1

ASM Downloader 1.1.1

Screen Copy Record File Comment Test n°12

Save Record File to TXT Downloading Ok 1

Heure	Temps (s)	Hydrée (%)	Pinbet	Break Points
04h34:10	274.10	5.00E-9	3.40E1	
04h34:20	274.20	5.00E-9	3.40E1	
04h34:30	274.30	5.00E-9	3.40E1	
04h34:40	274.40	5.00E-9	3.40E1	
04h34:50	274.50	5.00E-9	3.40E1	
04h34:60	274.60	5.00E-9	3.40E1	
04h34:70	274.70	5.00E-9	3.40E1	
04h34:80	274.80	8.00E-11	2.40E1	
04h34:90	274.90	8.00E-11	2.40E1	

Separation cursor between 2 successive recordings (100 separation cursors maximum)

Separation message between 2 successive recordings

On the control panel, close the specific software



Control panel with graphic interface

Animated synoptic Synoptic reading

Please refer to the "Change of interface" paragraph to reach it.

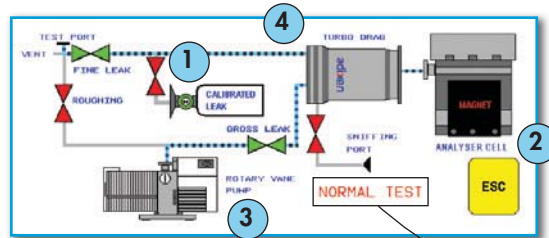

Etat du detecteur

① ② ③ ④ interactive components

- Valve closed
- Valve opened
- Inactive canalization
- Active canalization: gas flow

When you press on the interactive components, you have a section of the component or its operating principle. To return to the original illustration, press again on the component.

Example

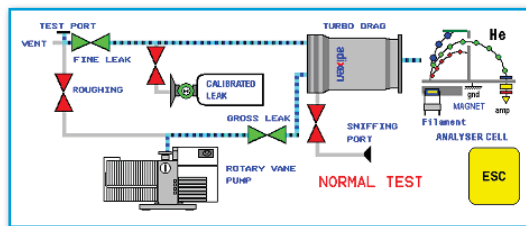
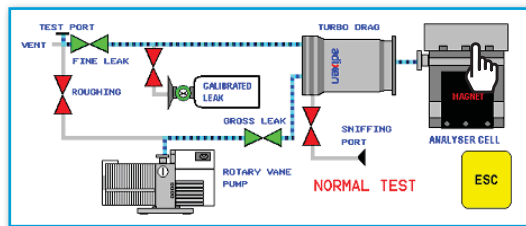

Note:

- The synoptic is personalized for each leak detector.

Long distance sniffer probe and Helium spray gun

Please refer to the specific sheets for the instruction:



Long distance sniffer probe
 G 400 / G 410



Helium spray gun  G 500

Inlet vent

A help for control panel utilization/access.

Operating principle of the control panel



Setting and maintenance part presentation of the control panel



Access to parameters and parameters active depending on authorization

Access to level 4 - Password



Summary of screens



Complete displays list with access way and associated sheet

Choices proposed to the operator

The operator can connect the leak detector:

- to the vent air function,
- the gas line option (ASM 182 TD+ only).

At any time, during or after test, the inlet status is displayed on the LCD and it is possible to control it (except for user level interface 1).

The proposed default value is "off" (= valve closed).

Inlet: Air Vent

Air vent purpose

At the end of a test cycle, 2 possibilities are available:

- venting (putting back to atmospheric pressure)
- not venting (keeping under vacuum) the part or installation tested.

This one can be made in a automatic or forced way.

That is why, the operator should program the following parameters:

- air vent at the end of a test cycle ("air off"/"air on")
- activation of this air vent ("automatic"/"operator").

Air inlet activation at the end of the cycle	Air inlet at the end of the cycle	After the test
Automatic	On	Automatic air inlet
	Off	No automatic air inlet
Operator	On	No automatic air inlet
	Off	Forced way air inlet by the operator

Inlet vent

Air vent Opening / Closing

Stand-by screen

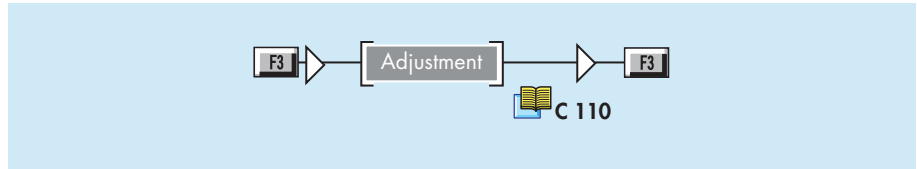

The inlet vent status indicated in the stand-by screen gives always the inlet vent valve status on the stand-by

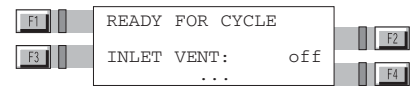

- On => valve opened
- Off => valve closed

Air vent adjustment

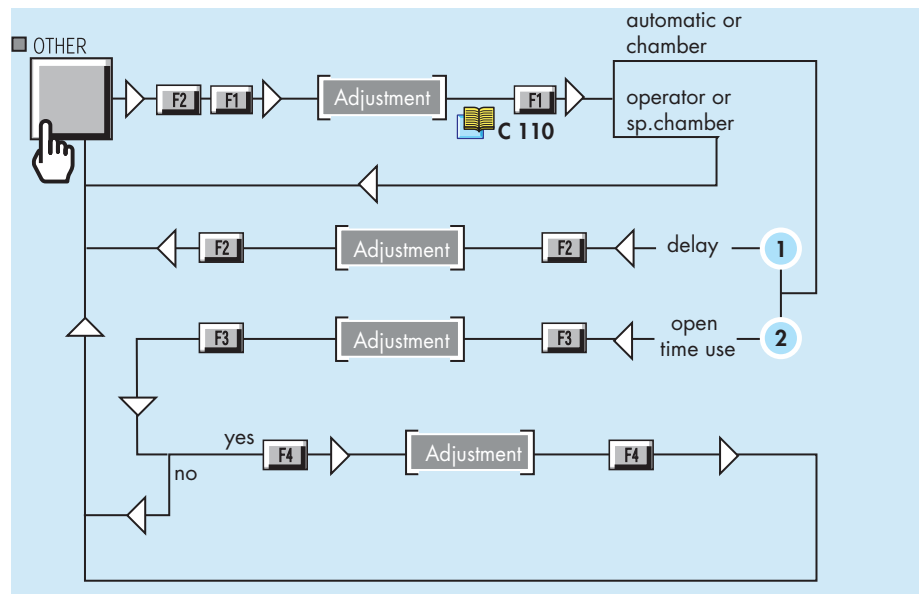

Note:

- 1** Delay - Time between the end of the cycle and the inlet vent valve opening. Only 3 possibilities: 0 - 1 s - 2 s
- 2** Open time use - The user can close again the inlet vent valve after opening (yes/no). When used (yes), set timer = time between inlet vent valve opening and inlet vent valve closing again.

Inlet: gas line option

(ASM 182 TD+ only)

C 420

Bargraph zoom

A help for control panel utilization/access.			
Operating principle of the control panel	C 110	Access to level 4 - Password	C 130
Setting and maintenance part presentation of the control panel Access to parameters and parameters active depending on authorization	C 120	Summary of screens Complete displays list with access way and associated sheet	C 140

Purpose This function offers a better resolution of the readout as well as a better view of the helium signal behaviour around the set point.

This function requires a remote control or a control panel with an analog display use.

Activate/deactivate the bargraph zoom

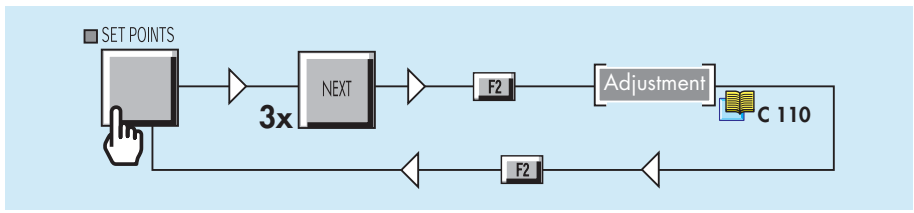

Bargraph zoom

Analog display

When a bargraph zoom is activated, use the helium signal zero scale: a blinking led indicates the reject point.

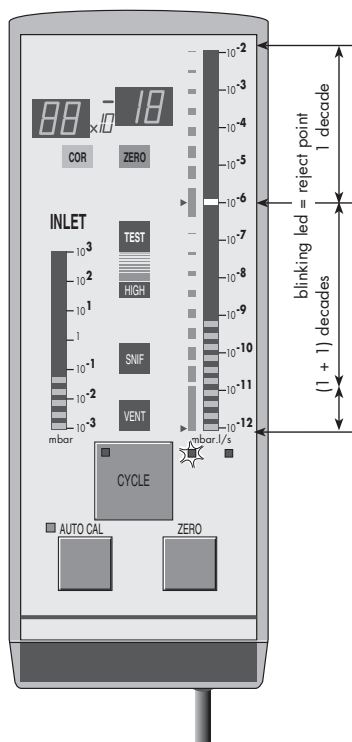

Remote control

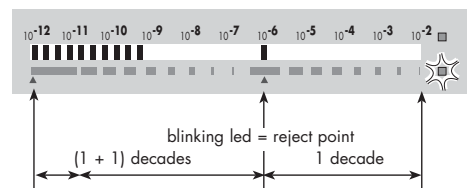

Control panel (plate removed).

The helium signal zero scale displays the leak value in 2 colors following the measured leak value:

- if the measured leak value is under the reject point, the flashing leds are green,
- if the measured leak value exceeds the reject point, the flashing leds are red (and the blinking led orange).

Reject point C 211

Zero function & Bargraph zoom

When bargraph zoom and zero functions are ON in the same time, the operator must read measured leak value in this way as follow:

- digital display

The leak value displayed is the value corrected with zero function.

Zero function C 540

- analog display

Use the helium signal zero scale.

The analog display is the actual bargraph zoom display (see above).

Audio alarm / Digital voice

A help for control panel utilization/access.			
Operating principle of the control panel	C 110	Access to level 4 - Password	C 130
Setting and maintenance part presentation of the control panel Access to parameters and parameters active depending on authorization	C 120	Summary of screens Complete displays list with access way and associated sheet	C 140

Audio alarm definition

The Audio alarm appears differently, based on the Zero function.

- Zero function is not activated:
The Audio alarm is started when the helium signal is exceeding a set point and called reject point.
- Zero function is activated:
The audio alarm threshold is then called "floating". It is slightly set above the zero level and will be triggered for any rise of the helium signal.

Zero function C 540

Digital voice definition

The digital voice informs the operator by sending audio messages in the following cases:

- starting-up process and auto-calibration process
- when detector is ready
- rejected part
- fault.

General

At any time it is possible to adjust the volume:
 ■ to increase volume ■ to decrease volume



Sound level

The level varies from 0 to 8 (= 90 dBA).

Adjustment

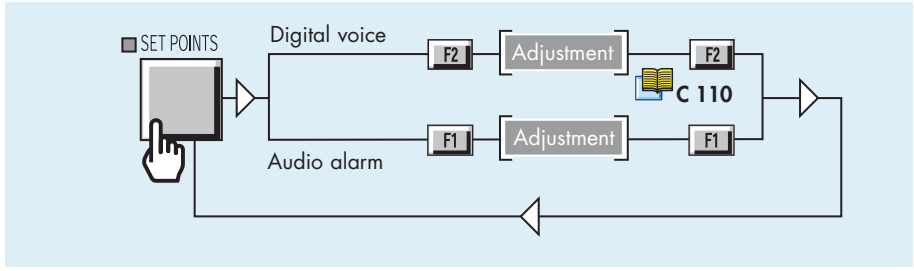

Cycle end

To consider the tested part as bad, it is necessary to activate the Memo function.

Memo function  C 550

- **Measure**

If Cycle end is activated (automatic), user should adjust the measure timer i.e. the cycle end.

The measure timer corresponds to the time allowed for the leak detector to remain in test. When it is reached, the measure flashes.

Zero function

A help for control panel utilization/access.

Operating principle of the control panel

 C 110

Setting and maintenance part presentation of the control panel

 C 120

Access to parameters and parameters active depending on authorization

Access to level 4 - Password

 C 130

Summary of screens

 C 140

Complete displays list with access way and associated sheet

Purpose Zero function is provided:

- to help the operator to identify a very small fluctuation of the helium signal out of the ambient background,
- to enlarge small fluctuations of the helium signal on the analog display.

The zero function could be activated:

- by the operator,
- in automatic.

It's advised to use this function when helium background signal is low.

Activate the zero function

The process of the zero function is the same whatever the activation mode (operator or automatic). The only difference is when the background suppression activation is automatic, the operator does not need to press .

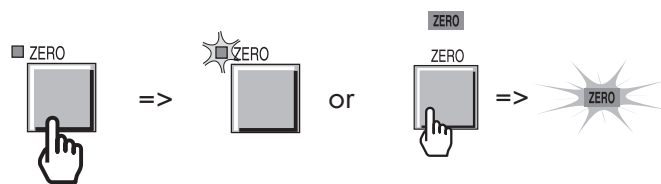

Principle example

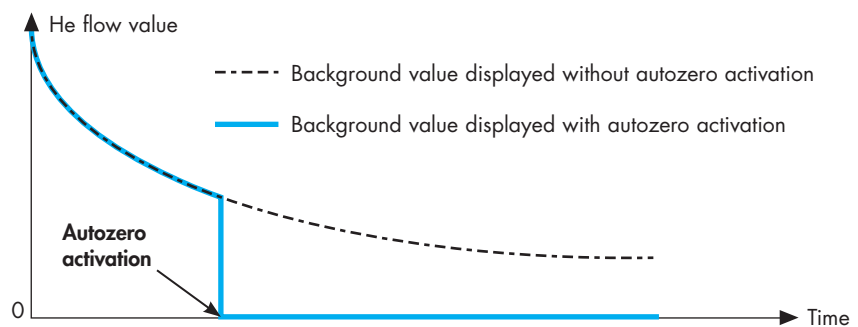

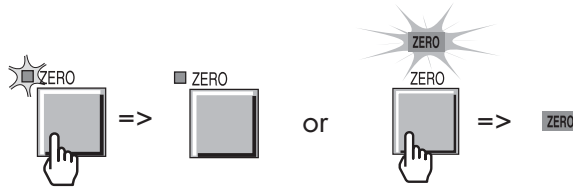

Zero function

Deactivate the zero function

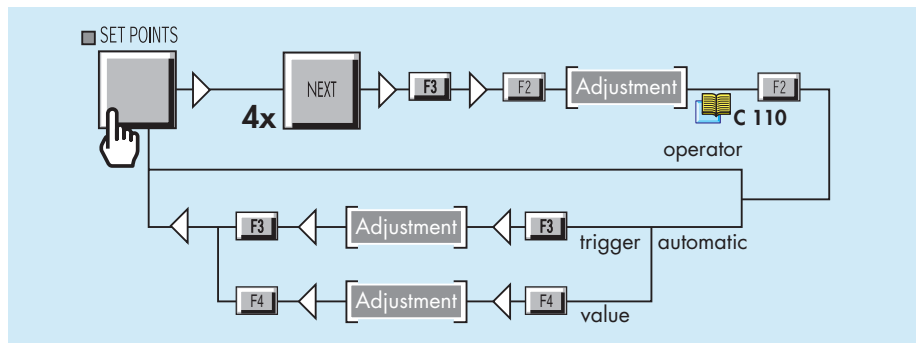

Activation/Deactivation of the background



The trigger parameter corresponds to the value at which the zero function is selected. It could be a timer or set point.
 (= press  if activation = operator)

The autozero will start:
 - every time that the parameted set point is reached (if trigger set).
 - regulary, depending on the defined frequency (if timer set).

Display

- Display changes according to the activation or not of the "bargraph zoom on reject point" ( C 510) function.
- Example with a calibrated leak of $1 \cdot 10^{-8}$ mbar·l/s

Zero not activated

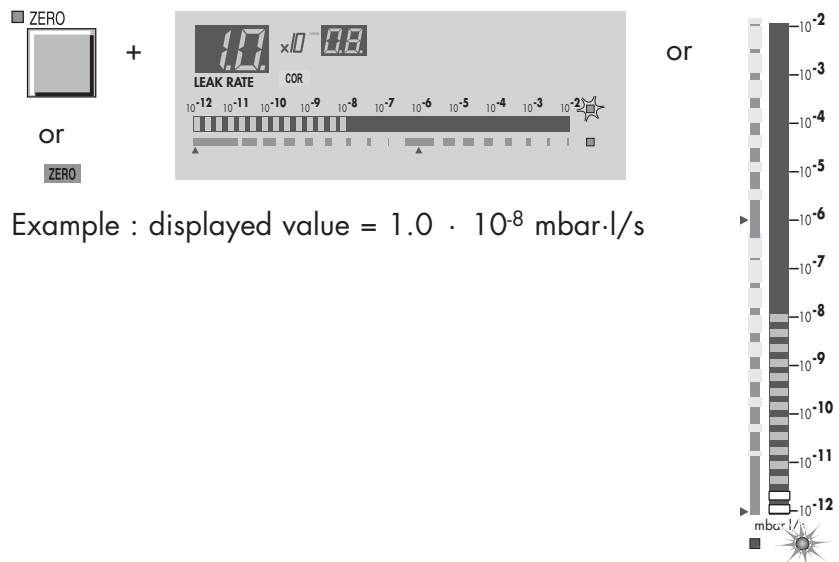

Example : displayed value = $1.0 \cdot 10^{-8}$ mbar·l/s

Zero function

Zero activated

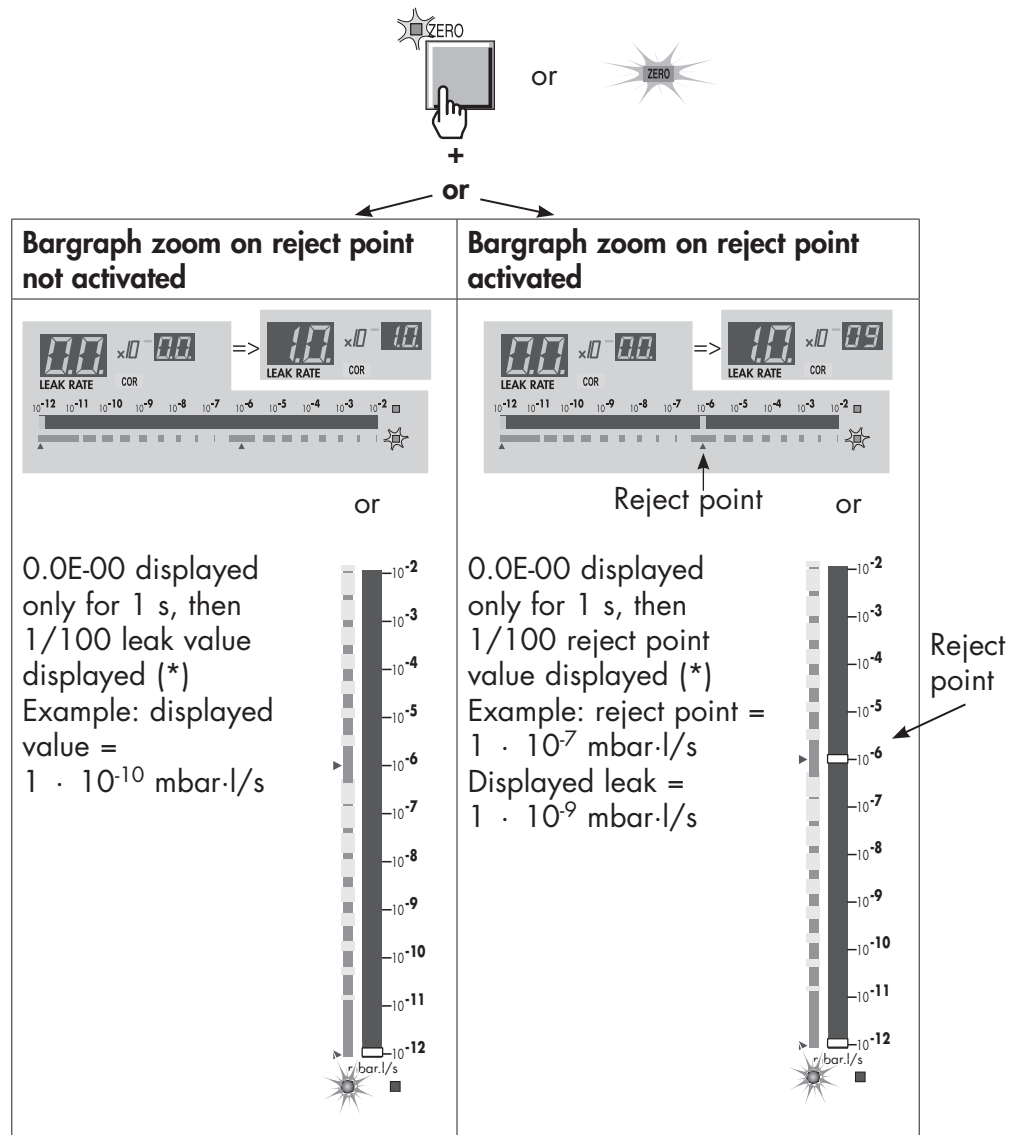

(*) Note: The 1/100 reject point value or 1/100 leak value displayed is limited to the low limit of the measurement range in the selected test mode.

Example: ASM 142 in Normal test mode

Test mode	mbar·l/s
Gross leak	$1 \cdot 10^{-9}$ to 1
Normal	$1 \cdot 10^{-11}$ to $3 \cdot 10^{-4}$
Sniffing	$1 \cdot 10^{-7}$ to $1 \cdot 10^{-1}$

The 1/100 reject point value or 1/100 leak value will never be lower than $1 \cdot 10^{-11}$ mbar·l/s.

Refer to **A 800** for the limit values according to the leak detector.

Memo function

A help for control panel utilization/access.	
Operating principle of the control panel	C 110
Setting and maintenance part presentation of the control panel	C 120
Access to parameters and parameters active depending on authorization	
Access to level 4 - Password	C 130
Summary of screens	C 140
Complete displays list with access way and associated sheet	

Purpose This function freezes the display showing the result of the previous test. The measured value flashes and blinks until a new test cycle is started (display timer deactivated).

Activate/Deactivate the memo function

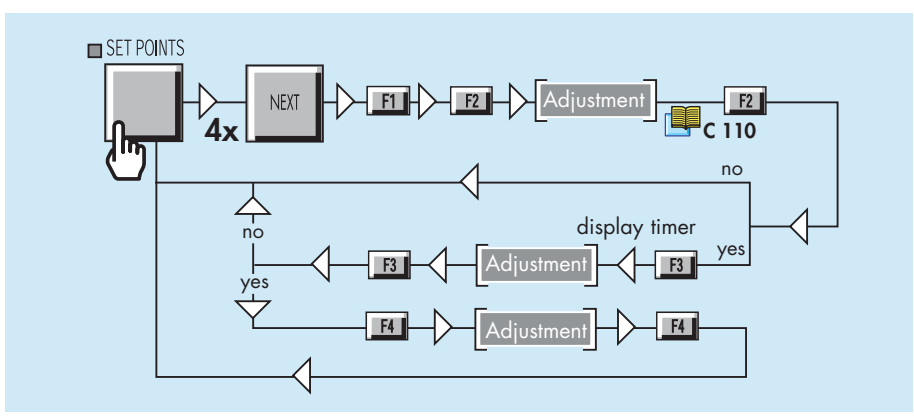

Display timer Once the memo function is activated, user has the possibility to activate or not the display timer. Display timer determines the time during which measured leak value is displayed.

Helium pollution prevention

A help for control panel utilization/access.			
Operating principle of the control panel	C 110	Access to level 4 - Password	C 130
Setting and maintenance part presentation of the control panel Access to parameters and parameters active depending on authorization	C 120	Summary of screens Complete displays list with access way and associated sheet	C 140

Purpose The helium pollution prevention function prevents the detector from being polluted by helium when the part or installation to be tested contains a lot of helium.
Leak detector in test mode, if the signal increases quickly above depollution reject point, the cycle is automatically ended and the leak detector stays in stand-by mode until the helium has decreased.

Note: There is no message to inform the operator that the detector is over again ready for a new test.

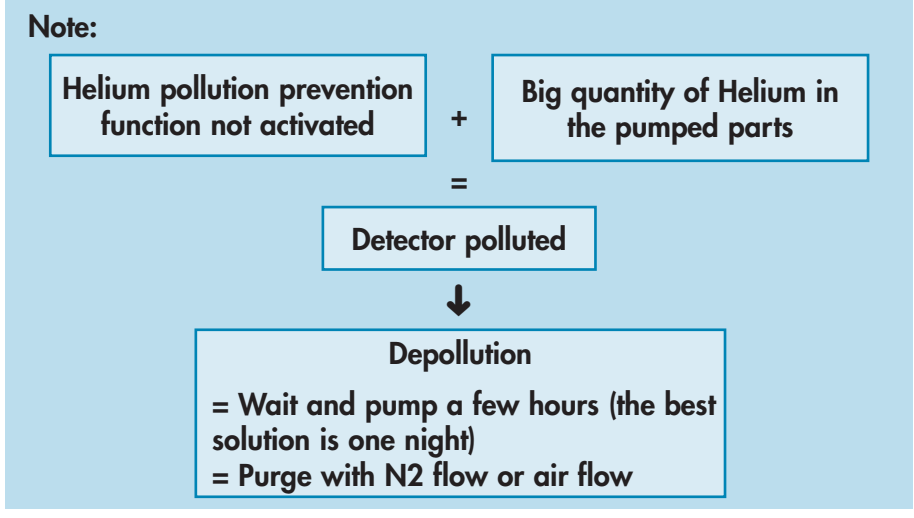

Note: When the detector reaches the 10^{-4} mbar threshold, it automatically pass in gross leak test mode.

Activate/Deactivate the Helium pollution prevention

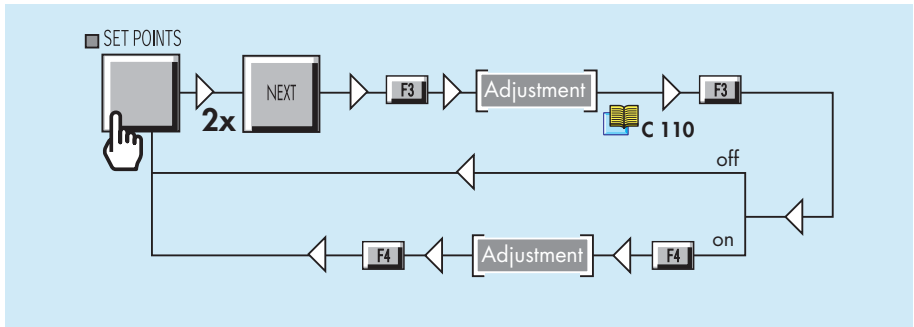

G38 00270 - Edition 06 - February 14

Date - Time - Language - Unit

A help for control panel utilization/access.			
Operating principle of the control panel	C 110	Access to level 4 - Password	C 130
Setting and maintenance part presentation of the control panel	C 120	Summary of screens	C 140
Access to parameters and parameters active depending on authorization		Complete displays list with access way and associated sheet	

Adjustment procedure

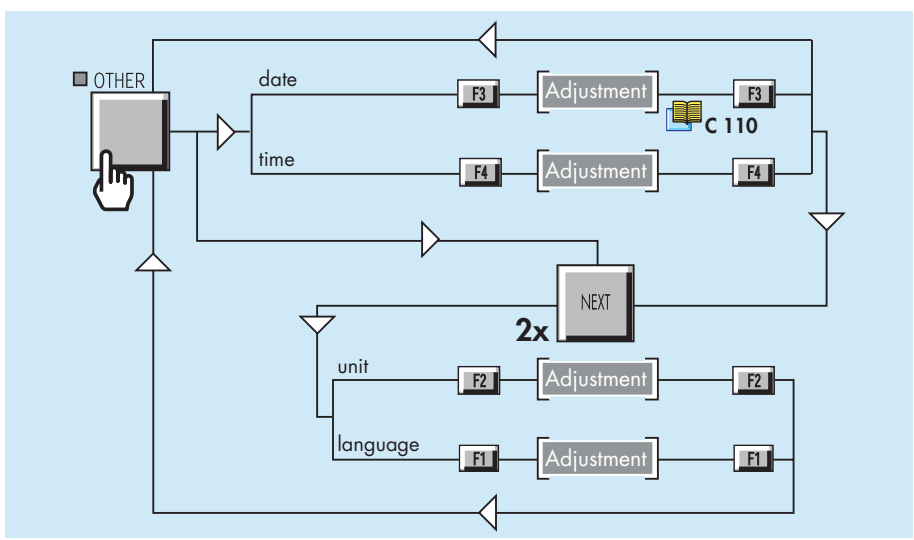

Date The leak detector calculates its storage period since the last switching off. C 200

Take care to set the correct date.

Language The leak detector offers 2,3 or 4 languages, according to the model.

Notes: A 600
 - All messages on the LCD are on the selected language.
 - The selected language is the language of the digital voice.

Digital voice C 520

Unit The leak detector offers 3 units:
 • mbar.l/s
 • Pa.m³/s
 • Torr.l/s

When the operator connects the remote control on the leak detector, the leak detector unit is automatically reprogrammed with the unit of the remote control. The remote control unit is memorized by the detector when the operator disconnects the remote control.

Fault / information indicator and display

Fault and information

At any time, the leak detector can display on the LCD clear Information or Fault messages based on the analysis of the leak detector status.

There are 3 basic types of faults: **minor fault**, **major fault** and **critical failure**.

There are 2 basic types of information: **user information** and **service information**.

The messages are displayed on a specific display by order of importance:

1. critical failure
2. major fault and minor fault
3. user information and service information

Faults Minor fault

3 fault types: minor fault, major fault and critical failure.

- Warning:
 - on the digital display alternatively the helium signal and "Er" are shown.
 - on the LCD, a "!" flashing at the right end of the 1st line.



The digital voice advises the operator of the procedure to follow.

- Result:
 - This will not stop the functions of the leak detector but can affect the validity of the test result.

- Message:
 - To read the message



A clear message describes the error on line 2 and 3. The most important warning message is displayed on the 1st line.

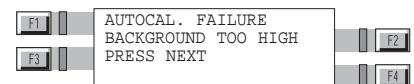

Up to 3 messages may be displayed on the message display.

- Duration: may be temporary or permanent
 - temporary if the fault appears and then disappears without a corrective action from the user
 - permanent until the cause is erased by the user.
- Remedy:
 - Temporary: the indicator disappears and the warning message is erased.
 - Permanent: both indicator and message are memorized until the fault is eliminated.

Fault / information indicator and display

Faults (cont.)

ASM 142 S and ASM 102 S special case:

- If after the start, the background is lower than the sniffer probe clogged point:
 - The "AL" message appears permanently on the digital display,
 - a «!» flashing at the right end of the screen.
- This default, although minor, is blocking. It is necessary to launch a calibration to make it disappear.



Major fault

- Warning:
 - on the digital display, "Er" is permanently displayed.
 - a flashing message occurs on the LCD

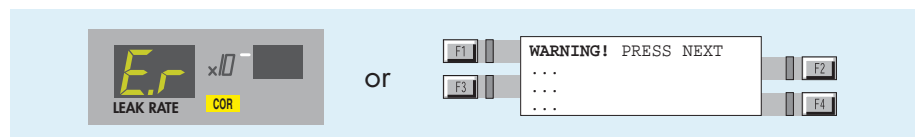

The digital voice advises the operator of the procedure to follow.

- Result:
 - May prevent the leak detector from making a vacuum test or an autocalibration

- Message:

To read the message 

Note: A major fault can behave like a temporary minor fault if the origin of the error has disappeared.

Critical failure

- Warning:
 - on the digital display, "Er" is permanently displayed. All indicators are turned off.
 - on the LCD the clear message of a critical failure is directly displayed. Details are displayed on line 2 and 3.

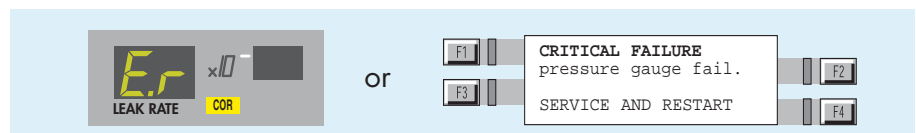

The digital voice advises the operator of the procedure to follow.

- Result:
 - Complete shut down of the leak detector is required.
- Remedy:
 - Need the servicing of the leak detector before starting it again.

Fault / information indicator and display

Information 2 information types: **user** and **service information**.

- Warning:
 - no indicator on the digital display
 - on the LCD, a "i" flashing at the right end of the 1st line.

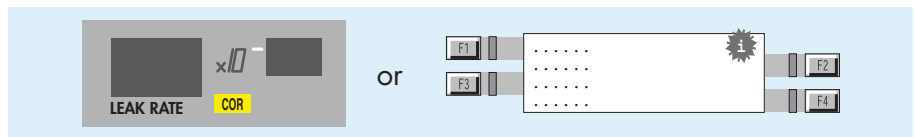

- The digital voice advises the operator of the procedure to follow.

- Result:
 - Doesn't affect the functions of the leak detector

- User information

Only an indication that the leak detector is in a particular status which may require an action from the user in order to return to a standard situation

- Service information

Only an indication that the leak detector requires a service or maintenance action.

- Message:

To read the message



A clear message describes the fault on line 2 and 3.

User information display

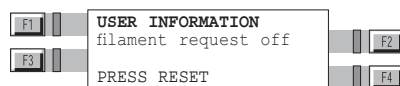

Service information display

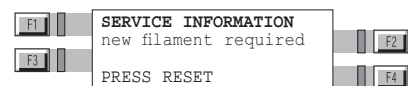

- Duration:

After display of the clear message, the indicator and the clear message are erased but they will be reactivated at the next start-up of the leak detector or at each unauthorized request by the user or 30 min later, if the origin of the message is still present.

- Remedy:

- User information

Can be eliminated by an action which is accessible by the user.

- Service information

Can be eliminated by a service action on the involved component and by resetting the corresponding configuration parameter. This is only accessible by the customer service.

Service instructions  E

Fault / information indicator and display

List of messages

For all messages, note their contents in order to identify the origin of the message and take the corresponding corrective action if necessary.

General troubleshooting guide  D 300

The RS 232 codes of these messages are described in the specific RS 232 user manual.

	User Information	Service Information	ASM 182 T	ASM 192 T	ASM 192 T2	ASM 182 TD+	ASM 192 TD+	ASM 192 T2D+	ASM 122 D	ASM 142	ASM 142 D	ASM 142 S	ASM 1002	ASM 102 S
Information messages														
auto. cal. required		•												
filament request off	•		•	•	•	•	•	•	•	•	•	•	•	•
manual calibration	•		•	•	•	•	•	•	•	•	•	•	•	•
auto. cal. aborted	•		•	•	•	•	•	•	•	•	•	•	•	•
drift too high (zero)	•		•	•	•	•	•	•	•	•	•		•	
He too high for zero	•		•	•	•	•	•	•	•	•	•		•	
He too low for zero	•		•	•	•	•	•	•	•	•	•		•	
external calib. Leak	•		•	•	•	•	•	•	•	•	•		•	
new fil#1 required		•	•	•	•	•	•	•	•	•	•		•	•
new fil#2 required		•	•	•	•	•	•	•	•	•	•		•	•
maintenance required		•	•	•	•	•	•	•	•	•	•		•	•
fil1-collector short		•	•	•	•	•	•	•	•	•	•		•	•
fil2-collector short		•	•	•	•	•	•	•	•	•	•		•	•
press zero & spray He	•		•	•	•	•	•	•	•	•	•		•	
no Hy leak for calib	•		•	•	•	•	•	•	•	•	•		•	
rough. MDP pump maint.		•						•(5)						
rough. ATP pump maint.		•						•(2)						•
auto. cal. required	•		•	•	•	•	•	•	•	•	•		•	•
external leak maint.		•												•
internal leak maint.		•												
primary pump maint.		•				•(4)	•(4)	•(4)	•(8)		•(10)			•(12)
high. vac pump maint		•	•(1)	•(1)	•(1)	•(1)	•(1)	•(1)	•(7)	•(9)	•(9)	•(9)	•(11)	•(5)
roughing pump maint.		•			•(2)	•(3)	•(3)		•(6)		•(5)			

- (1) TMP 5154
- (2) ATP 100
- (3) MDP 5011
- (4) ACP 28

- (5) MDP 5006 HDS
- (6) ATH 31+
- (7) ATH 31
- (8) Dry pump

- (9) AMP 007 I
- (10) AMD 1
- (11) ATH 164
- (12) Diaphragm pump

Fault / information indicator and display

Error message	Minor failure	Major failure	Critical failure	ASM 182 T	ASM 192 T	ASM 192 T2	ASM 182 TD+	ASM 192 TD+	ASM 192 T2D+	ASM 122 D	ASM 142	ASM 142 D	ASM 142 S	ASM 1002	ASM 102 S
autocal failure	•			•	•	•	•	•	•	•	•	•	•	•	•
temperature too low	•			•	•	•	•	•	•	•	•	•	•	•	•
temperature too high	•			•	•	•	•	•	•	•	•	•	•	•	•
cal. leak year error	•			•	•	•	•	•	•	•	•	•	•	•	•
peak search error	•			•	•	•	•	•	•	•	•	•	•	•	•
peak adjust error	•			•	•	•	•	•	•	•	•	•	•	•	•
background too high	•			•	•	•	•	•	•	•	•	•	•	•	•
emission loss	•			•	•	•	•	•	•	•	•	•	•	•	•
cell. zero off limits	•			•	•	•	•	•	•	•	•	•	•	•	•
cell. zero stability	•			•	•	•	•	•	•	•	•	•	•	•	•
calib. test mode lost	•			•	•	•	•	•	•	•	•	•	•	•	•
sensitivity too high	•			•	•	•	•	•	•	•	•	•	•	•	•
background trouble	•			•	•	•	•	•	•	•	•	•	•	•	•
lack of sensitivity	•			•	•	•	•	•	•	•	•	•	•	•	•
cell.pressure safety		•		•	•	•	•	•	•	•	•	•	•	•	•
triode safety		•		•	•	•	•	•	•	•	•	•	•	•	•
emission failure		•		•	•	•	•	•	•	•	•	•	•	•	•
snif. probe clogged		•		•	•	•	•	•	•	•	•	•	•	•	•
high. vac pump speed		•		•	•	•	•	•	•	•	•	•	•	•	•
cell pres.>0.01 mbar			•	•	•	•	•	•	•	•	•	•	•	•	•
high. vac pump fail			•	•	•	•	•	•	•	•	•	•	•	•	•
cell pres.>1e-04 mbar			•	•	•	•	•	•	•	•	•	•	•	•	•
filaments #1 bad			•	•	•	•	•	•	•	•	•	•	•	•	•
no collector voltage			•	•	•	•	•	•	•	•	•	•	•	•	•
time keeper ram fail.			•	•	•	•	•	•	•	•	•	•	•	•	•
cell. gauge failure			•	•	•	•	•	•	•	•	•	•	•	•	•
rough. pump failure	•					•(2)	•(3)	•(3)	•(2)	•(6)		•(5)			
24 V DC troubles	•			•	•	•	•	•	•	•	•	•	•	•	•
mini reject point on	•													•	
check ATH connector			•							•(7)					
check AMP connector			•								•(9)	•(9)	•(9)		•(5)
check TMP connector			•	•(1)	•(1)	•(1)	•(1)	•(1)	•(1)					•(11)	
check ATH connector			•							•(6)					
check MDP connector			•				•(3)	•(3)	•(5)			•(5)			
check ATP connector			•			•(2)			•(2)						
LDS probe problem		•											•		•

Fault / information indicator and display

	Minor failure	Major failure	Critical failure	ASM 182 T	ASM 192 T	ASM 192 T2	ASM 182 TD+	ASM 192 TD+	ASM 192 T2D+	ASM 122 D	ASM 142	ASM 142 D	ASM 142 S	ASM 1002	ASM 102 S
Error message															
dynamic cal failure	•														
bad RAM integrity	•														
fil1-collector short		•		•	•	•	•	•	•	•	•	•	•	•	•
fil2-collector short		•		•	•	•	•	•	•	•	•	•	•	•	•
fil1-collector short			•	•	•	•	•	•	•	•	•	•	•	•	•
fil2-collector short			•	•	•	•	•	•	•	•	•	•	•	•	•
high. vac pump speed			•	•	•	•	•	•	•	•	•	•	•	•	•
rough. pump failure			•			•(2)	•(3)	•(3)	•(2)	•(6)		•(5)			
primary pump failure			•		•(12)	•(12)	•(4)	•(4)	•(4)					•(12)	

- (1) TMP 5154
- (2) ATP 100
- (3) MDP 5011
- (4) ACP 28

- (5) MDP 5006 HDS
- (6) ATH 31+
- (7) ATH 31
- (8) Dry pump

- (9) AMP 007 I
- (10) AMD 1
- (11) ATH 164
- (12) Diaphragm pump



Appendix

ASM 182 T - ASM 192 T - ASM 192 T2 Operating instructions Detailed contents

Preliminary remarks Throughout this operating manual, you could find this type of message “**Summary of screen  C 140**”: it refers to a specific chapter of the operating manual. Please read it for further information.

G 100 *Declaration of conformity*

G 200 *ASM 182 T - Wiring diagrams*

G 201 *ASM 192 T - Wiring diagrams*

G 202 *ASM 192 T2 - Wiring diagrams*

G 300 *Analog outputs*

- 0 - 10 Volt
- 0 - 8 Volt

G 400 *Long distance sniffer probe user manual*

- Dimensions
- Technical characteristics
- Use precautions with the flexible sniffer probe
- Flow adjustment
- Available spare parts
- Filter exchange
- Needle replacement
- O’ring installation
- « Sniffer probe clogged » message
- Adaptor for calibrated leak

G 500 *Helium spray gun user manual*

- Description
- Technical characteristics
- Use precaution
- Spare parts

G 600 *Service*

G 800 *Tools*

- ASM View supervisory Software
- ASM Downloader software
- ADX Dialog (Detection) software
- ASM Pocket Dialogue software

Declaration of conformity



Declaration of conformity

We hereby declare that the product cited below satisfies all relevant provisions according to the following EC directives :

- Machinery 2006/42/EC (Annex II, No. 1 A)
- Electromagnetic Compatibility 2014/30/EU
- Restriction of Hazardous Substances 2011/65/EU
- Waste of Electrical and Electronical Equipments 2012/19/EU

The technical file is drawn up by Mr Gilles Baret, Pfeiffer Vacuum, Société par Actions Simplifiées [simplified joint stock company], 98, avenue de Brogny B.P. 2069, 74009 Annecy cedex, France.

**ASM 182 T / ASM 182 TD+
ASM 192 T / ASM 192 TD+ / ASM 192 T2 / ASM 192 T2D+**

Harmonised standards and national standards and specifications which have been applied :

Standards NF EN-61000-6-2 : 2005
Standards NF ENV-50204 : 1996
Standards NF EN-60204-1: 2006

Signatures :

Pfeiffer Vacuum SAS
98, avenue de Brogny
B.P. 2069
74009 Annecy
France

(M. Taberlet)
Président

(M. Baret)
Directeur Produits et Technologies

Date
12/06/2016

G 200

Wiring diagrams - ASM 182 T (index A)

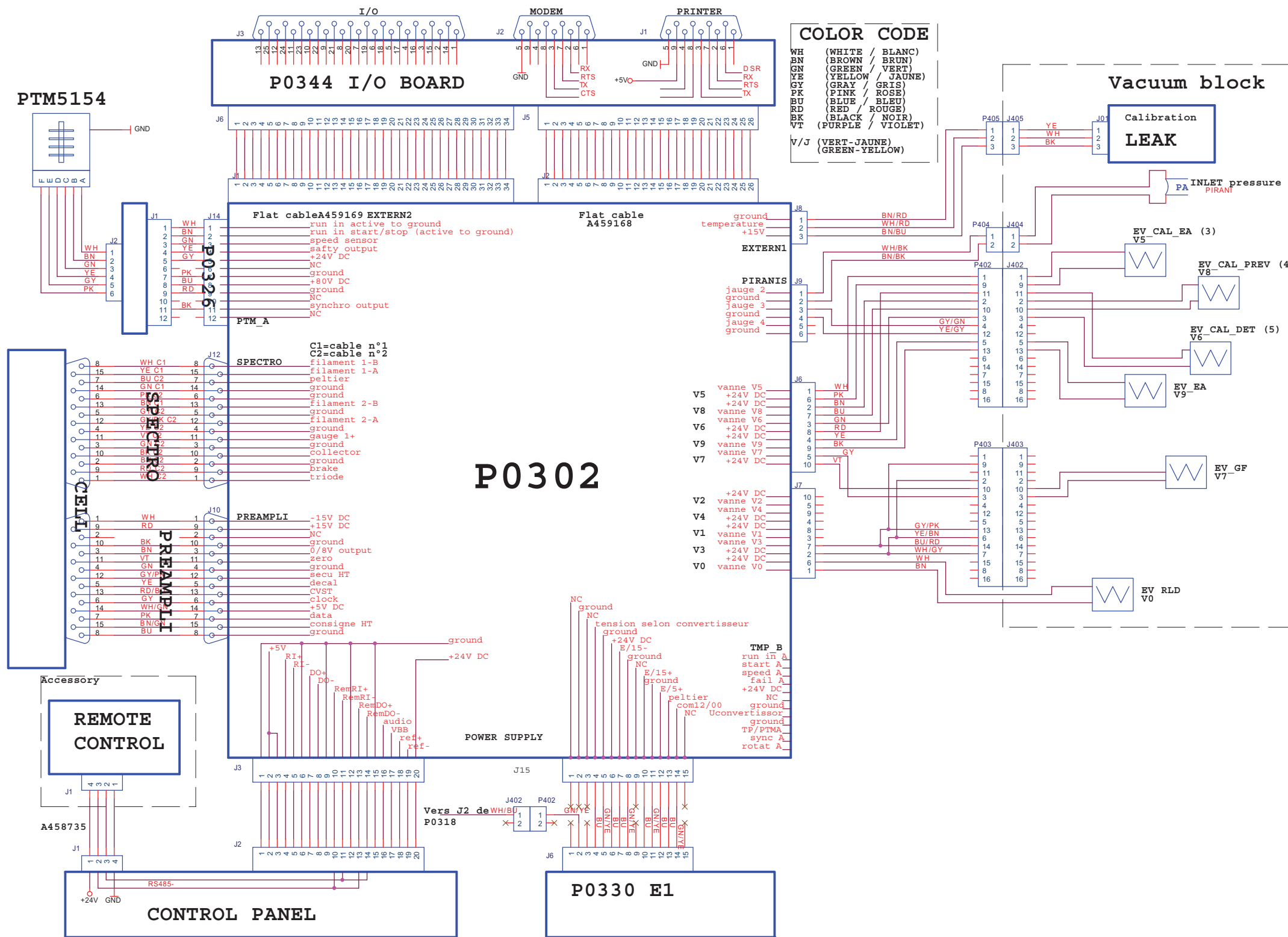

G 200

Wiring diagrams - ASM 182 T (index A)

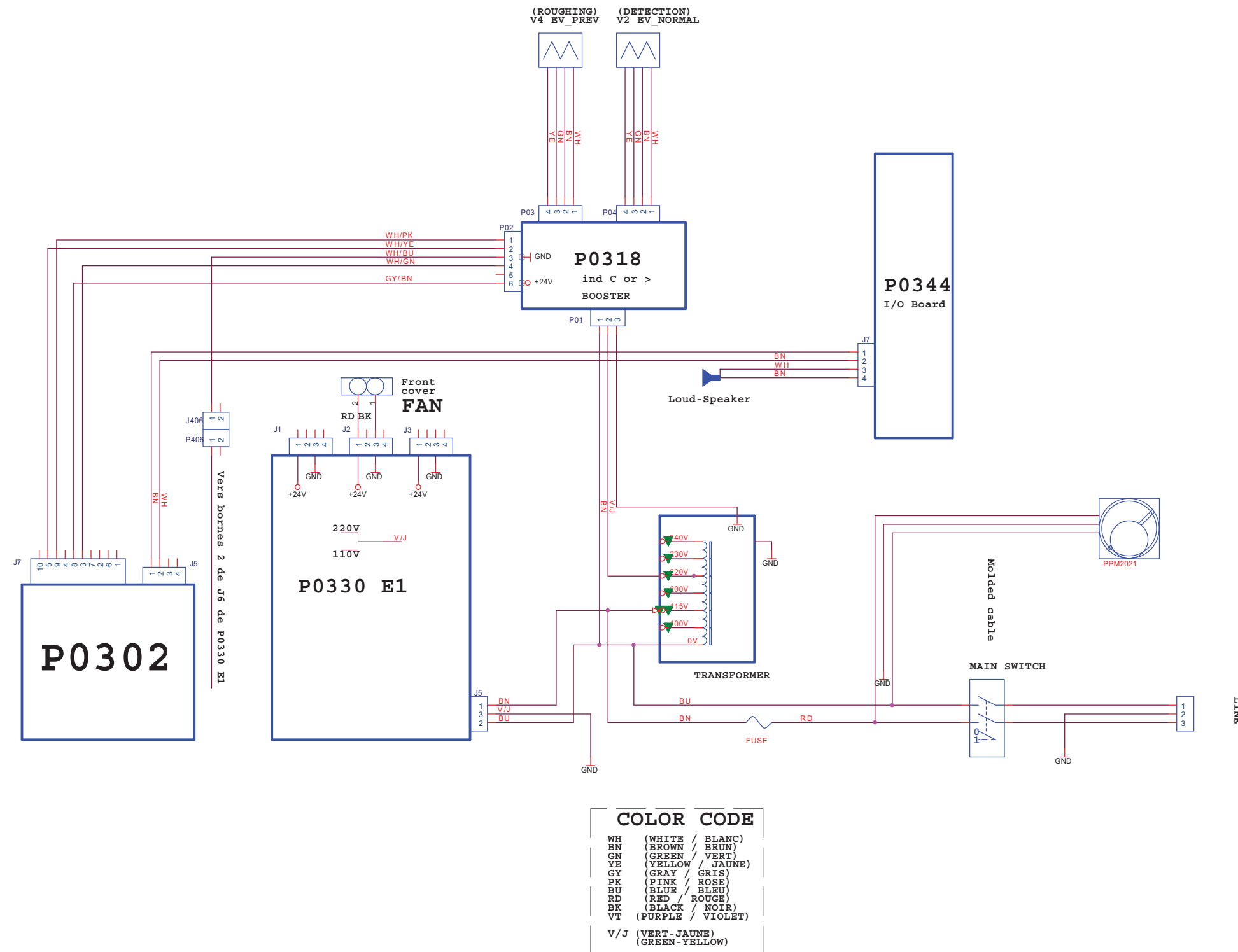

Wiring diagrams - ASM 182 T (index A)

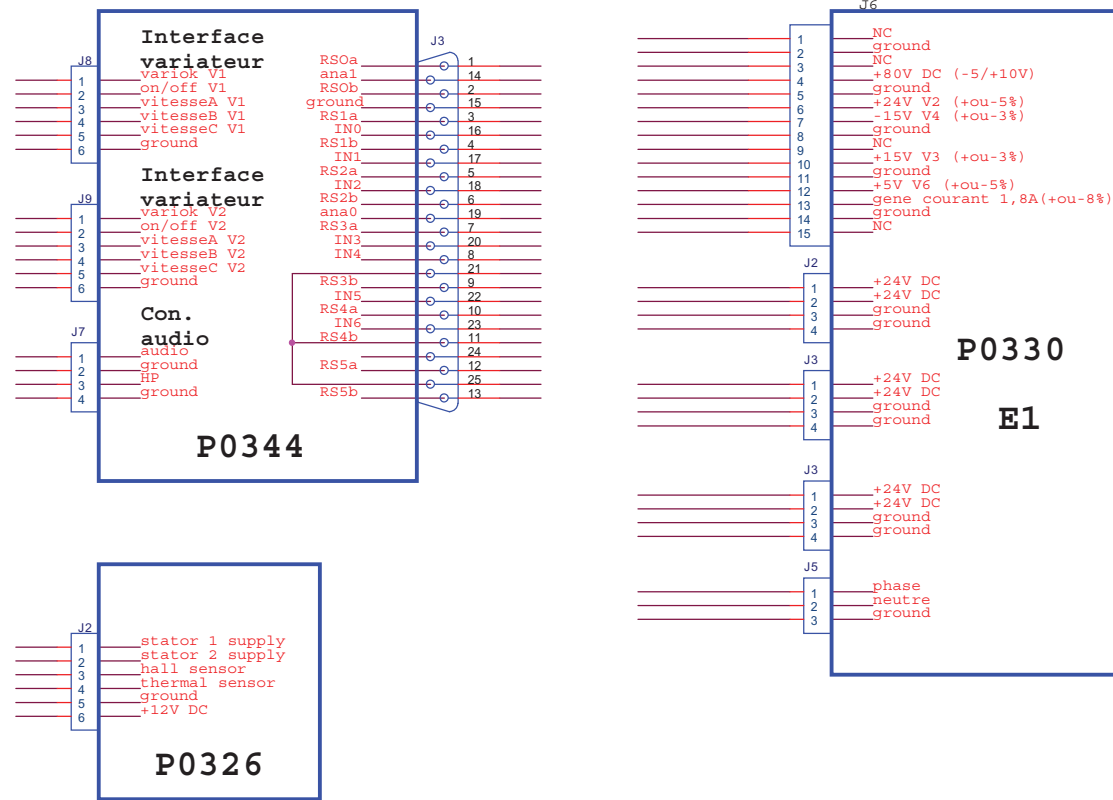

G 201

Wiring diagrams - ASM 192 T (index -)

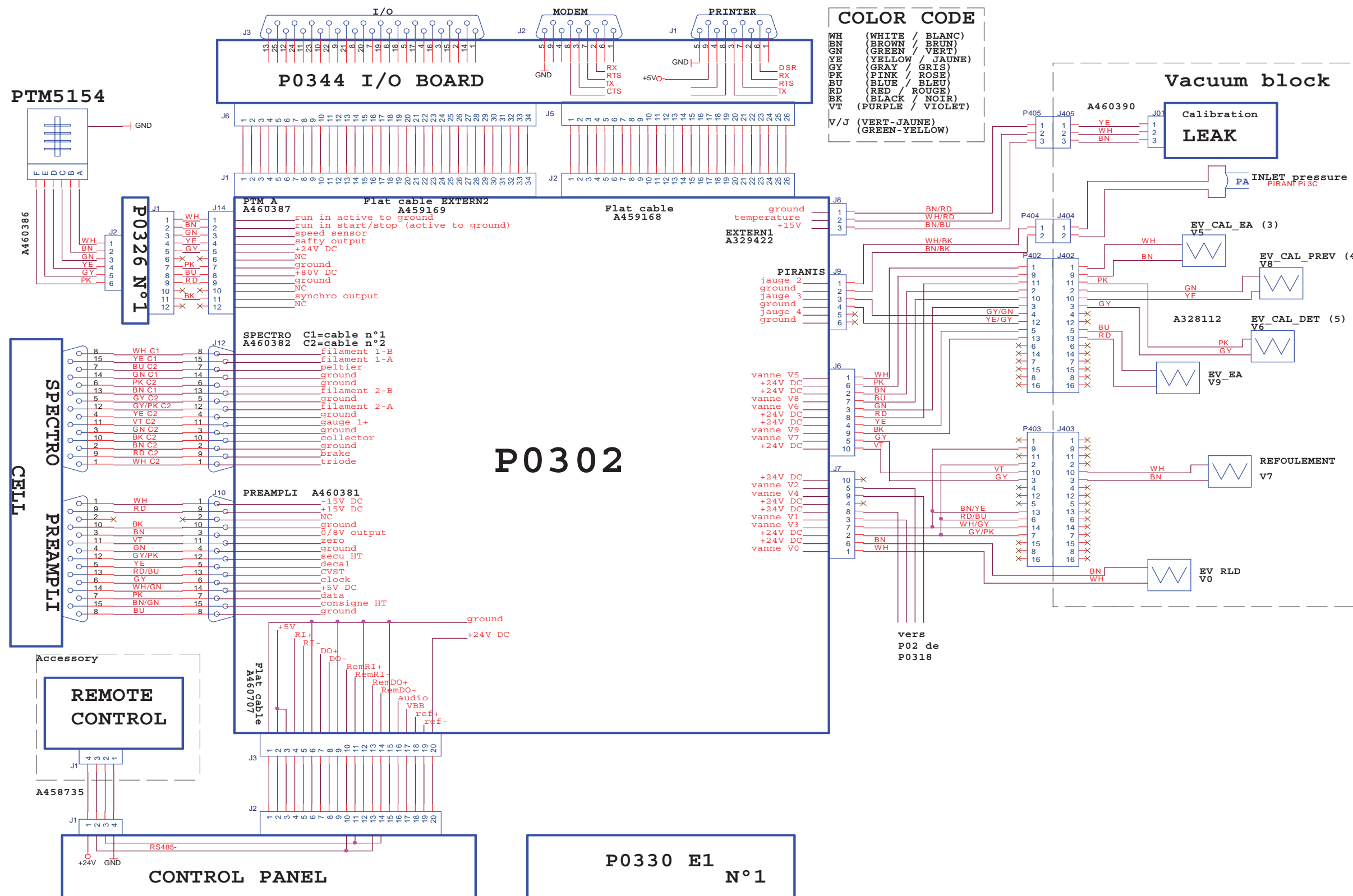

G 201

Wiring diagrams - ASM 192 T (index -)

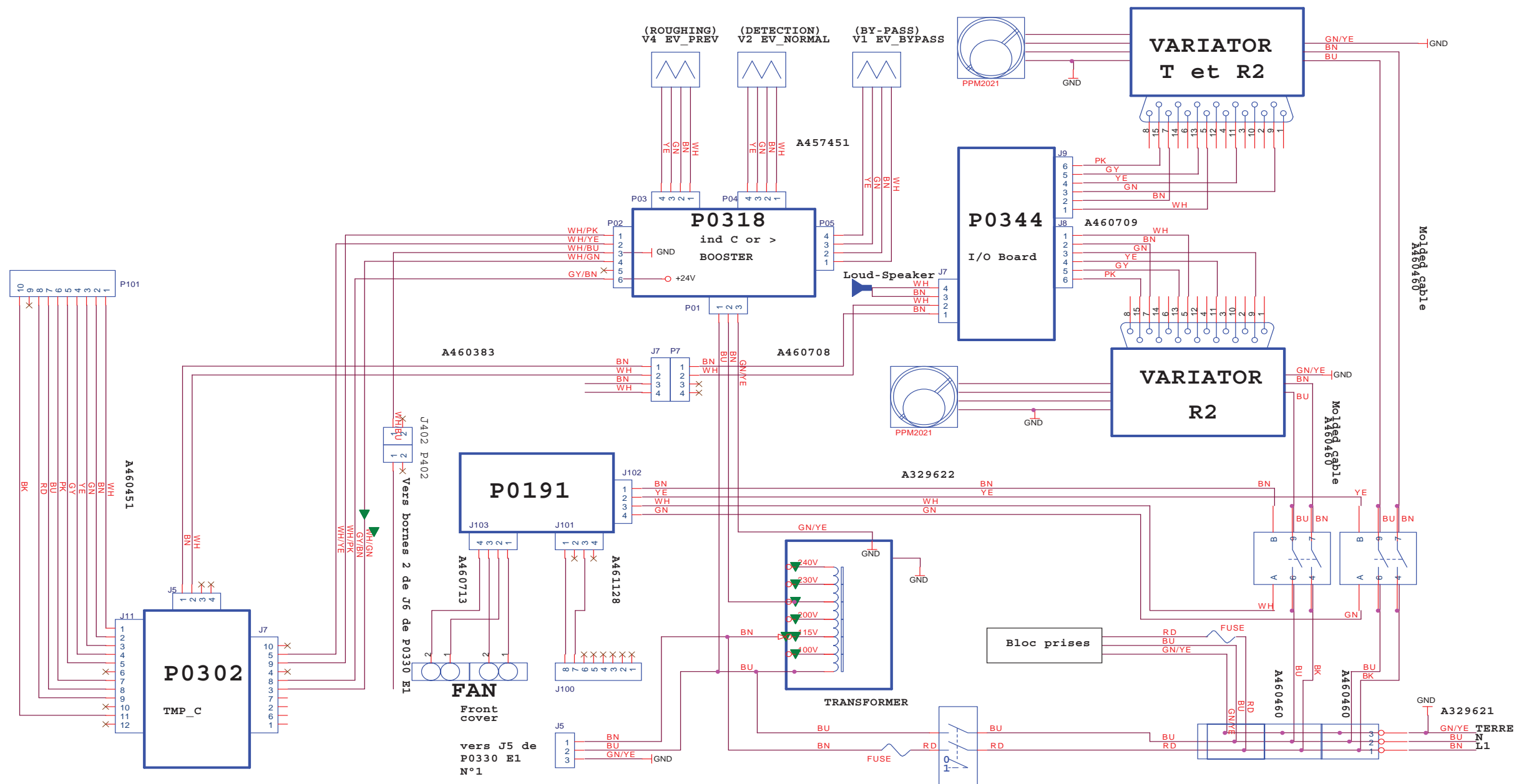

COLOR CODE	
WH	(WHITE / BLANC)
BN	(BROWN / BRUN)
GN	(GREEN / VERT)
YE	(YELLOW / JAUNE)
GY	(GRAY / GRIS)
PK	(PINK / ROSE)
BU	(BLUE / BLEU)
RD	(RED / ROUGE)
BK	(BLACK / NOIR)
VT	(PURPLE / VIOLET)
V/J	(VERT-JAUNE) (GREEN-YELLOW)

G 201

Wiring diagrams - ASM 192 T (index -)

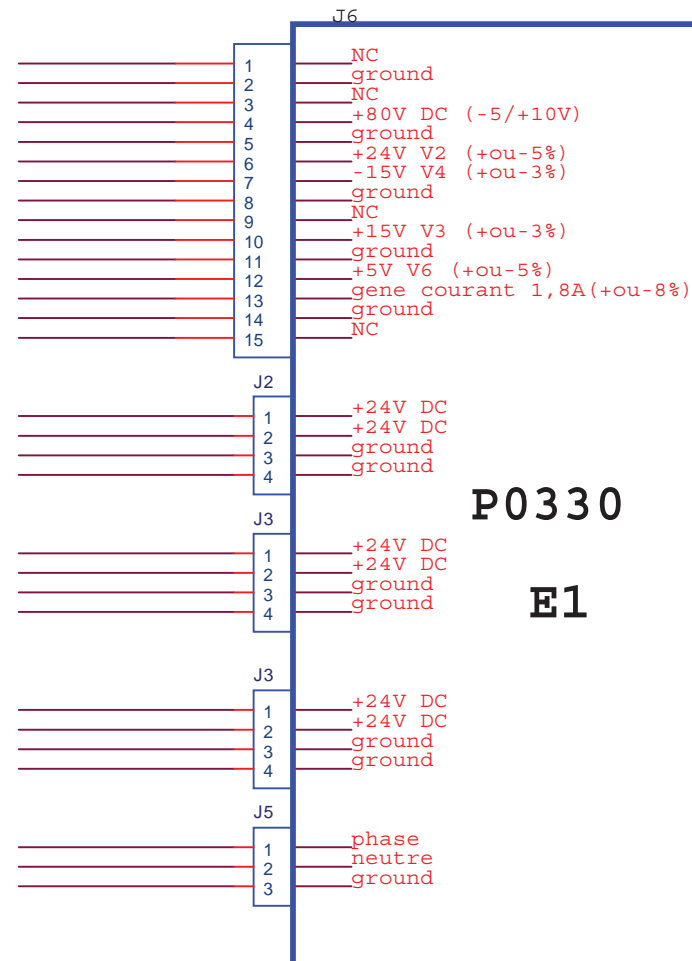
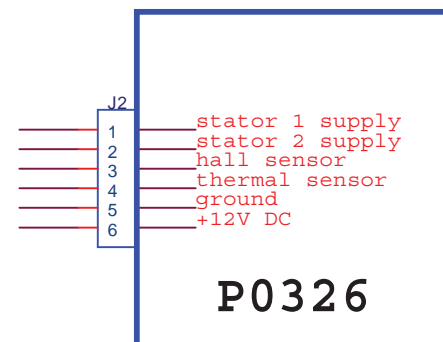
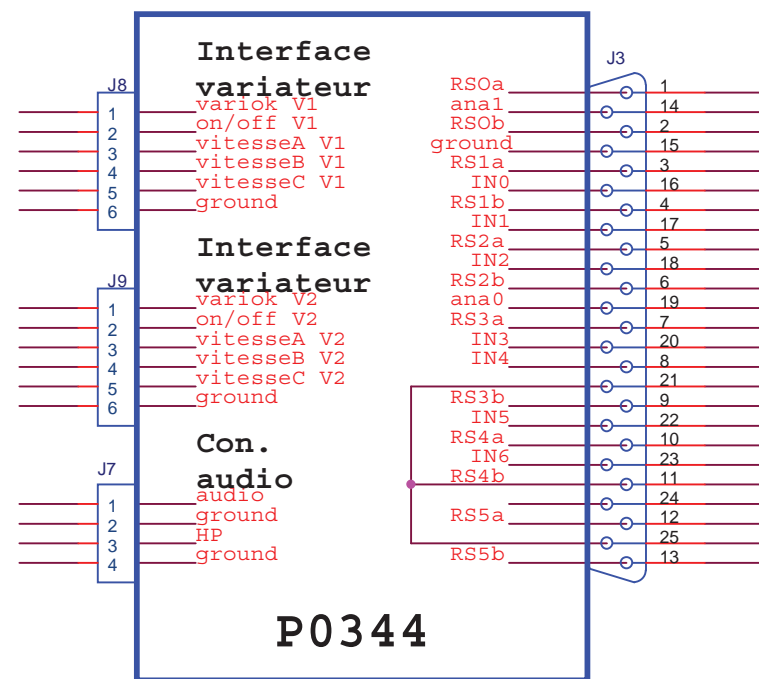

G 202

Wiring diagrams - ASM 192 T2 (index -)

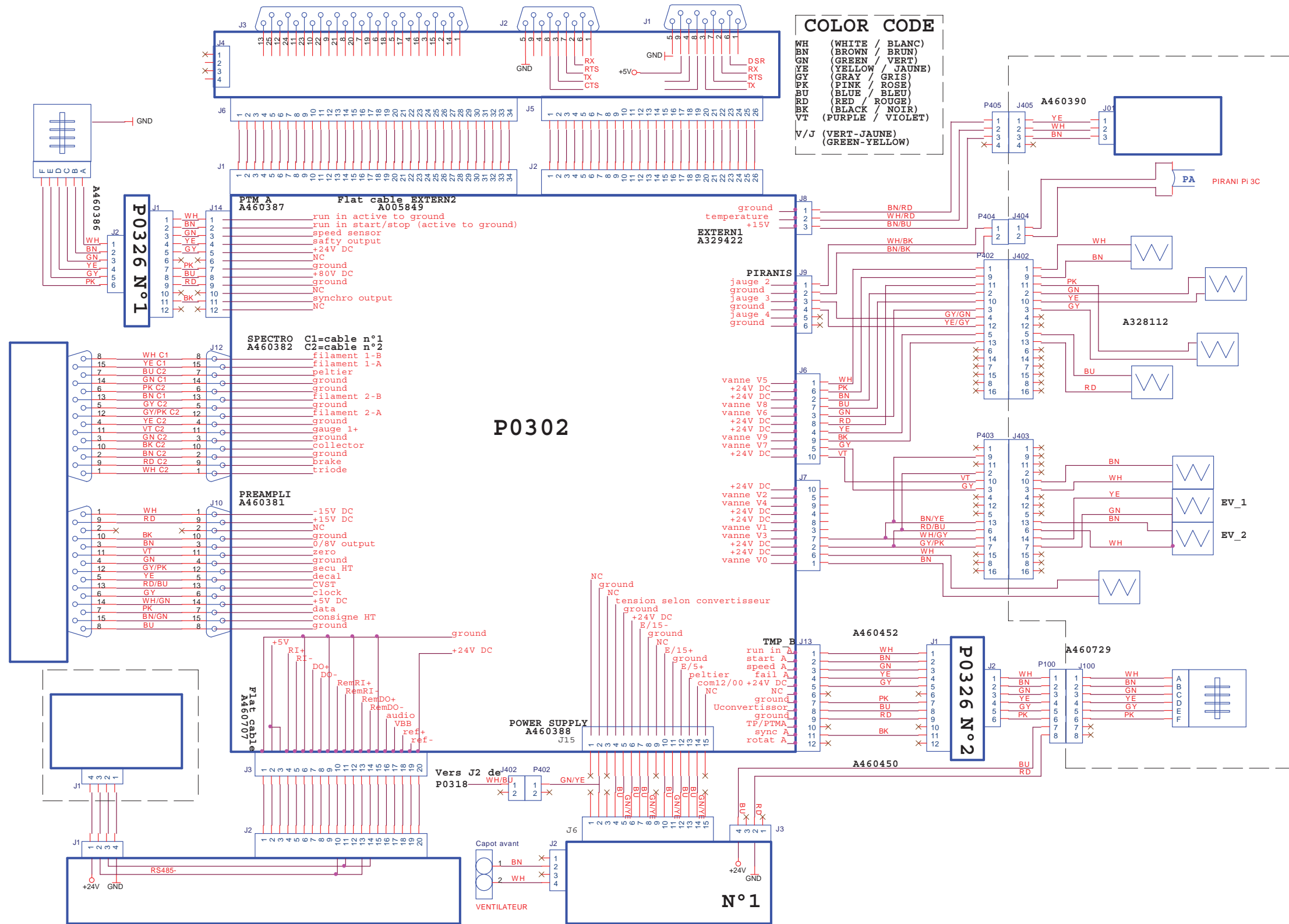

G 202

Wiring diagrams - ASM 192 T2 (index -)

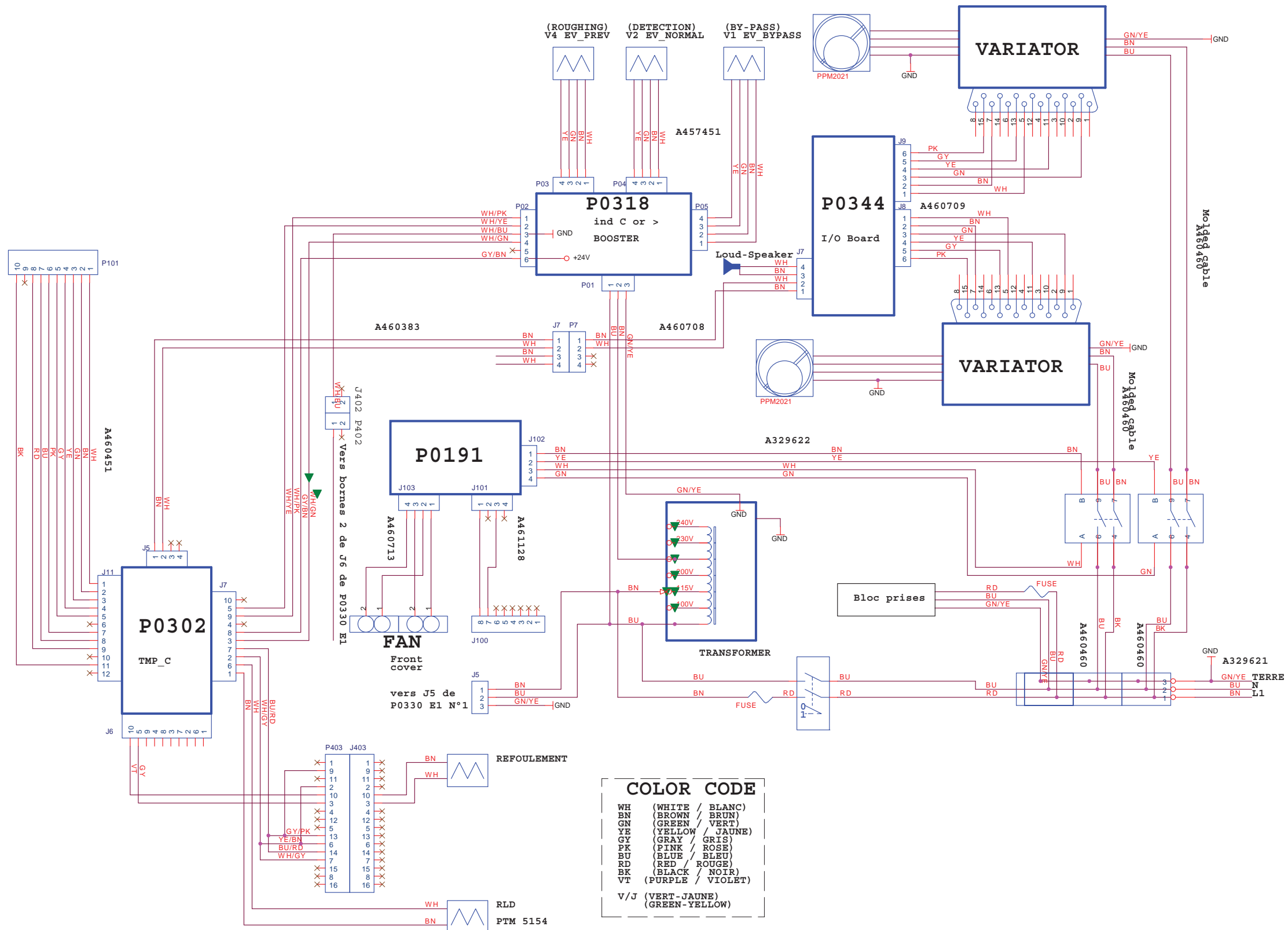

G 202

Wiring diagrams - ASM 192 T2 (index -)

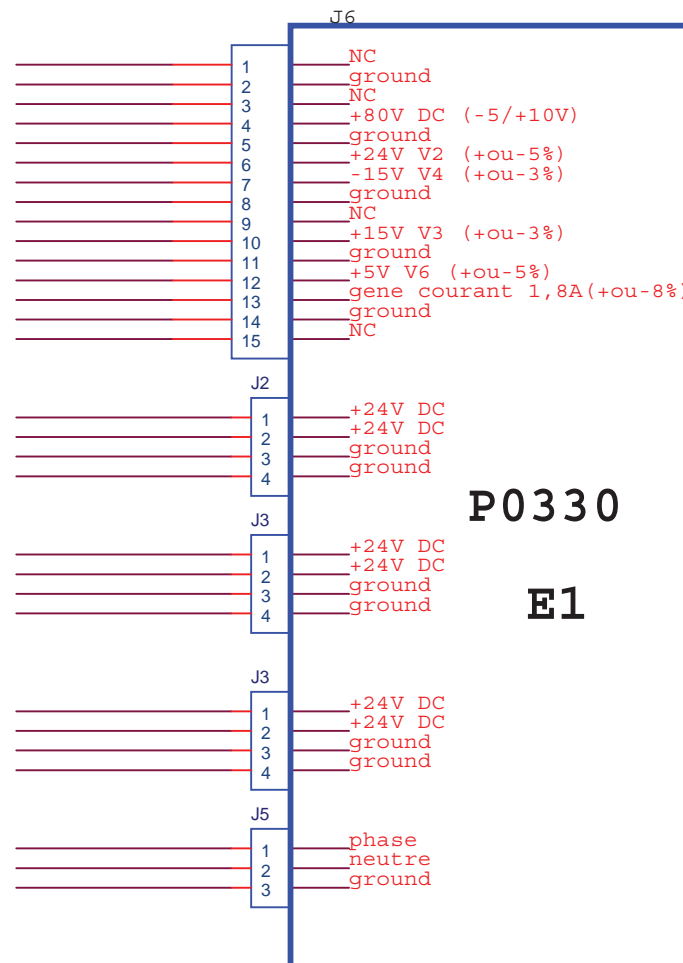
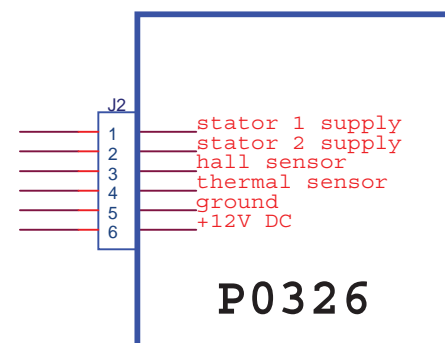
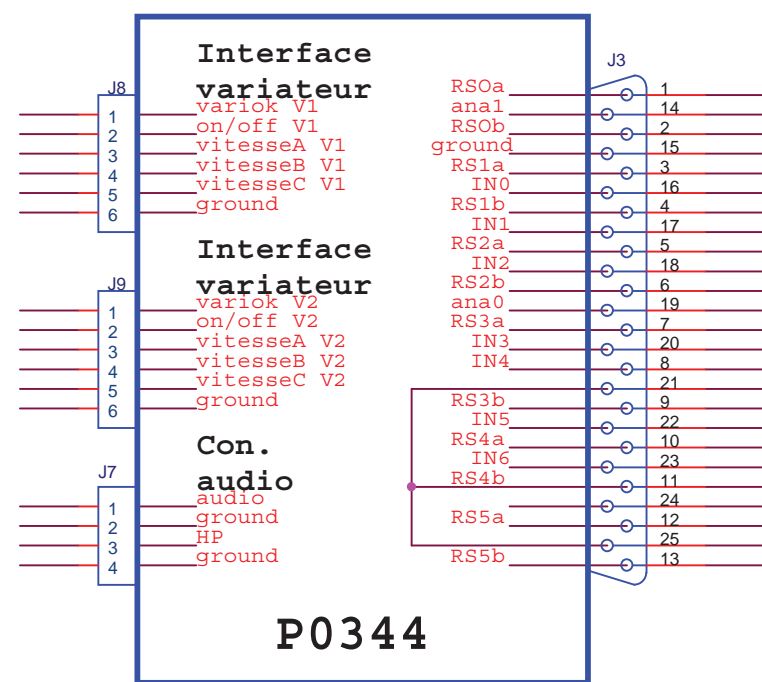

Analog outputs

The purpose of the present chapter is to present the logarithmic response of this output.

0 - 10 Volt

To get directly the corrected helium signal as it is displayed on the Digital display, use the 0 - 10 Volt linear output (refer to  B 300) on the same I/O interface connector.

Note: the pressure analog output is not the same as the helium output.

$$\begin{array}{l} \text{Pressure P (mbar)} \\ \text{Voltage V (volt)} \end{array} \left| \begin{array}{l} \rightarrow \\ \rightarrow \end{array} \right. P = 10^{(U-5,5)} \text{ mbar}$$

0 - 8 Volt

Reminder:

- The 0 - 8 Volt logarithmic output is located on the I/O interface connector:

	Ground	0 / 8 V
ASM 182/192 family - ASM 1002	Pin 15	Pin 14
ASM 142 family - ASM 122 D - ASM 102 S - ASI 22	Pin 1	Pin 14

- ASM 182/192 family, ASM 1002: signal connected (COEF.SENS and COEF.MODE applied)
- ASM 142 family, ASM 122 D, ASM 102 S, ASI 22: signal not corrected.

■ This output corresponds to the electronic signal obtained with the best sensitivity mode of the leak detector.

■ This output corresponds to the electronic signal obtained at the level of the analyzer cell (VHS amplification system) and does not include the correction factors generated by the internal and external calibration.

■ The chart and curve shows the correspondance between output voltage and helium signal. **The helium signal given by the present chart needs to be multiplied by COEF.SENS which is adjusted during the internal (auto)calibration:** refer to Calibration or Configuration menus (see Chapter C) in order to get access to COEF.SENS value. This COEF.SENS value is modified at each autocalibration: its takes into account the fact that the characteristics of the leak detector (analyzer cell and pumps status) and evaluates as it is used.

■ If an external correction ratio like VAC COR, SNIF COR or GL COR is activated, the helium signal given by the present chart also needs to be multiplied by this ratio: refer  C 300.

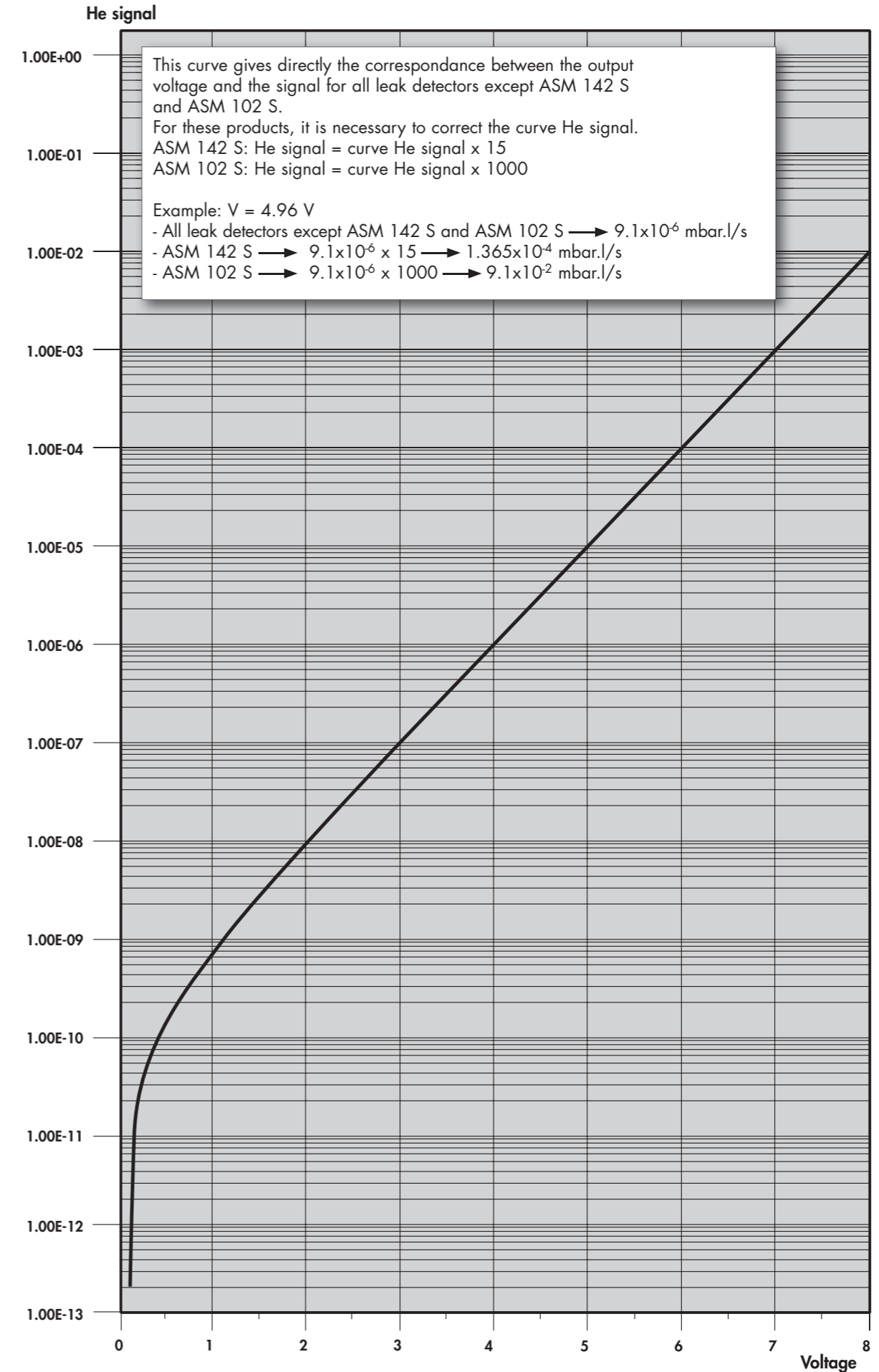

G 300

Analog outputs

Compressed format: $131E-09 = 1.31 \times 10^{-7}$

Volts	HS mode	Volts	HS mode	Volts	HS mode	Volts	HS mode	Volts	HS mode	Volts	HS mode	Volts	HS mode	Volts	HS mode	Volts	HS mode	Volts	HS mode								
Leak rate		Leak rate		Leak rate		Leak rate		Leak rate		Leak rate		Leak rate		Leak rate		Leak rate		Leak rate									
0.08	191E-15	0.65	216E-12	1.22	122E-11	1.79	532E-11	2.36	213E-10	2.93	821E-10	3.5	311E-09	4.07	117E-08	4.64	435E-08	5.21	162E-07	5.78	602E-07	6.35	224E-06	6.92	832E-06	7.49	309E-05
0.09	161E-14	0.66	224E-12	1.23	125E-11	1.8	546E-11	2.37	218E-10	2.94	841E-10	3.51	318E-09	4.08	119E-08	4.65	445E-08	5.22	166E-07	5.79	616E-07	6.36	229E-06	6.93	851E-06	7.5	316E-05
0.1	307E-14	0.67	232E-12	1.24	129E-11	1.81	560E-11	2.38	224E-10	2.95	861E-10	3.52	326E-09	4.09	122E-08	4.66	456E-08	5.23	170E-07	5.8	631E-07	6.37	234E-06	6.94	871E-06	7.51	324E-05
0.11	459E-14	0.68	240E-12	1.25	132E-11	1.82	574E-11	2.39	229E-10	2.96	881E-10	3.53	333E-09	4.1	125E-08	4.67	466E-08	5.24	174E-07	5.81	645E-07	6.38	240E-06	6.95	891E-06	7.52	331E-05
0.12	616E-14	0.69	248E-12	1.26	136E-11	1.83	588E-11	2.4	235E-10	2.97	902E-10	3.54	341E-09	4.11	128E-08	4.68	477E-08	5.25	178E-07	5.82	661E-07	6.39	245E-06	6.96	912E-06	7.53	339E-05
0.13	778E-14	0.7	257E-12	1.27	139E-11	1.84	603E-11	2.41	240E-10	2.98	924E-10	3.55	349E-09	4.12	131E-08	4.69	488E-08	5.26	182E-07	5.83	676E-07	6.40	251E-06	6.97	933E-06	7.54	347E-05
0.14	946E-14	0.71	266E-12	1.28	143E-11	1.85	618E-11	2.42	246E-10	2.99	946E-10	3.56	357E-09	4.13	134E-08	4.7	500E-08	5.27	186E-07	5.84	692E-07	6.41	257E-06	6.98	955E-06	7.55	355E-05
0.15	112E-13	0.72	275E-12	1.29	147E-11	1.86	633E-11	2.43	252E-10	3	968E-10	3.57	366E-09	4.14	137E-08	4.71	511E-08	5.28	190E-07	5.85	708E-07	6.42	263E-06	6.99	977E-06	7.56	363E-05
0.16	130E-13	0.73	284E-12	1.3	151E-11	1.87	649E-11	2.44	258E-10	3.01	991E-10	3.58	374E-09	4.15	140E-08	4.72	523E-08	5.29	195E-07	5.86	724E-07	6.43	269E-06	7	100E-05	7.57	371E-05
0.17	148E-13	0.74	294E-12	1.31	155E-11	1.88	665E-11	2.45	264E-10	3.02	101E-09	3.59	383E-09	4.16	144E-08	4.73	535E-08	5.3	199E-07	5.87	741E-07	6.44	275E-06	7.01	102E-05	7.58	380E-05
0.18	167E-13	0.75	304E-12	1.32	159E-11	1.89	682E-11	2.46	271E-10	3.03	104E-09	3.6	392E-09	4.17	147E-08	4.74	548E-08	5.31	204E-07	5.88	758E-07	6.45	282E-06	7.02	105E-05	7.59	389E-05
0.19	187E-13	0.76	314E-12	1.33	164E-11	1.9	699E-11	2.47	277E-10	3.04	106E-09	3.61	401E-09	4.18	150E-08	4.75	561E-08	5.32	209E-07	5.89	776E-07	6.46	288E-06	7.03	107E-05	7.6	398E-05
0.2	208E-13	0.77	324E-12	1.34	168E-11	1.91	717E-11	2.48	284E-10	3.05	109E-09	3.62	411E-09	4.19	154E-08	4.76	574E-08	5.33	214E-07	5.9	794E-07	6.47	295E-06	7.04	110E-05	7.61	407E-05
0.21	229E-13	0.78	335E-12	1.35	173E-11	1.92	734E-11	2.49	291E-10	3.06	111E-09	3.63	420E-09	4.2	157E-08	4.77	587E-08	5.34	219E-07	5.91	813E-07	6.48	302E-06	7.05	112E-05	7.62	417E-05
0.22	250E-13	0.79	346E-12	1.36	177E-11	1.93	753E-11	2.5	298E-10	3.07	114E-09	3.64	430E-09	4.21	161E-08	4.78	601E-08	5.35	224E-07	5.92	832E-07	6.49	309E-06	7.06	115E-05	7.63	427E-05
0.23	273E-13	0.8	357E-12	1.37	182E-11	1.94	771E-11	2.51	305E-10	3.08	117E-09	3.65	440E-09	4.22	165E-08	4.79	615E-08	5.36	229E-07	5.93	851E-07	6.50	316E-06	7.07	117E-05	7.64	436E-05
0.24	296E-13	0.81	369E-12	1.38	187E-11	1.95	791E-11	2.52	312E-10	3.09	120E-09	3.66	451E-09	4.23	169E-08	4.8	629E-08	5.37	234E-07	5.94	871E-07	6.51	324E-06	7.08	120E-05	7.65	447E-05
0.25	320E-13	0.82	381E-12	1.39	192E-11	1.96	810E-11	2.53	320E-10	3.1	122E-09	3.67	461E-09	4.24	173E-08	4.81	644E-08	5.38	240E-07	5.95	891E-07	6.52	331E-06	7.09	123E-05	7.66	457E-05
0.26	344E-13	0.83	393E-12	1.4	197E-11	1.97	830E-11	2.54	327E-10	3.11	125E-09	3.68	472E-09	4.25	177E-08	4.82	659E-08	5.39	245E-07	5.96	912E-07	6.53	339E-06	7.1	126E-05	7.67	468E-05
0.27	370E-13	0.84	405E-12	1.41	202E-11	1.98	851E-11	2.55	335E-10	3.12	128E-09	3.69	483E-09	4.26	181E-08	4.83	674E-08	5.4	251E-07	5.97	933E-07	6.54	347E-06	7.11	129E-05	7.68	479E-05
0.28	396E-13	0.85	418E-12	1.42	208E-11	1.99	872E-11	2.56	343E-10	3.13	131E-09	3.7	495E-09	4.27	185E-08	4.84	690E-08	5.41	257E-07	5.98	955E-07	6.55	355E-06	7.12	132E-05	7.69	490E-05
0.29	423E-13	0.86	431E-12	1.43	213E-11	2	893E-11	2.57	351E-10	3.14	134E-09	3.71	506E-09	4.28	189E-08	4.85	706E-08	5.42	263E-07	5.99	977E-07	6.56	363E-06	7.13	135E-05	7.7	501E-05
0.3	451E-13	0.87	445E-12	1.44	219E-11	2.01	916E-11	2.58	360E-10	3.15	138E-09	3.72	518E-09	4.29	194E-08	4.86	723E-08	5.43	269E-07	6	1 000E-07	6.57	372E-06	7.14	138E-05	7.71	513E-05
0.31	479E-13	0.88	459E-12	1.45	225E-11	2.02	938E-11	2.59	369E-10	3.16	141E-09	3.73	530E-09	4.3	198E-08	4.87	740E-08	5.44	275E-07	6.01	102E-06	6.58	380E-06	7.15	141E-05	7.72	525E-05
0.32	509E-13	0.89	473E-12	1.46	230E-11	2.03	961E-11	2.6	377E-10	3.17	144E-09	3.74	543E-09	4.31	203E-08	4.88	757E-08	5.45	282E-07	6.02	105E-06	6.59	389E-06	7.16	145E-05	7.73	537E-05
0.33	539E-13	0.9	488E-12	1.47	236E-11	2.04	985E-11	2.61	386E-10	3.18	147E-09	3.75	555E-09	4.32	208E-08	4.89	774E-08	5.46	288E-07	6.03	107E-06	6.6	398E-06	7.17	148E-05	7.74	549E-05
0.34	571E-13	0.91	503E-12	1.48	243E-11	2.05	101E-10	2.62	396E-10	3.19	151E-09	3.76	568E-09	4.33	213E-08	4.9	793E-08	5.47	295E-07	6.04	110E-06	6.61	407E-06	7.18	151E-05	7.75	562E-05
0.35	603E-13	0.92	518E-12	1.49	249E-11	2.06	103E-10	2.63	405E-10	3.2	155E-09	3.77	582E-09	4.34	218E-08	4.91	811E-08	5.48	302E-07	6.05	112E-06	6.62	417E-06	7.19	155E-05	7.76	575E-05
0.36	637E-13	0.93	534E-12	1.5	256E-11	2.07	106E-10	2.64	415E-10	3.21	158E-09	3.78	595E-09	4.35	223E-08	4.92	830E-08	5.49	309E-07	6.06	115E-06	6.63	427E-06	7.2	158E-05	7.77	589E-05
0.37	671E-13	0.94	550E-12	1.51	262E-11	2.08	109E-10	2.65	425E-10	3.22	162E-09	3.79	609E-09	4.36	228E-08	4.93	849E-08	5.5	316E-07	6.07	117E-06	6.64	437E-06	7.21	162E-05	7.78	602E-05
0.38	706E-13	0.95	567E-12	1.52	269E-11	2.09	111E-10	2.66	435E-10	3.23	166E-09	3.8	624E-09	4.37	233E-08	4.94	869E-08	5.51	323E-07	6.08	120E-06	6.65	447E-06	7.22	166E-05	7.79	616E-05
0.39	743E-13	0.96	584E-12	1.53	276E-11	2.1	114E-10	2.67	445E-10	3.24	170E-09	3.81	638E-09	4.38	239E-08	4.95	889E-08	5.52	331E-07	6.09	123E-06	6.66	457E-06	7.23	170E-05	7.8	631E-05
0.4	780E-13	0.97	601E-12	1.54	283E-11	2.11	117E-10	2.68	456E-10	3.25	174E-09	3.82	653E-09	4.39	244E-08	4.96	910E-08	5.53	339E-07	6.1	126E-06	6.67	468E-06	7.24	174E-05	7.81	646E-05
0.41	819E-13	0.98	619E-12	1.55	291E-11	2.12	120E-10	2.69	467E-10	3.26	178E-09	3.83	669E-09	4.4	250E-08	4.97	931E-08	5.54	347E-07	6.11	129E-06	6.68	479E-06	7.25	178E-05	7.82	661E-05
0.42	858E-13	0.99	637E-12	1.56	298E-11	2.13	123E-10	2.7	478E-10	3.27	182E-09	3.84	684E-09	4.41	256E-08	4.98	953E-08	5.55	355E-07	6.12	132E-06	6.69	490E-06	7.26	182E-05	7.83	676E-05
0.43	899E-13	1	656E-12	1.57	306E-11	2.14	126E-10	2.71	489E-10	3.28	186E-09	3.85	700E-09	4.42	262E-08	4.99	975E-08	5.56	363E-07	6.13	135E-06	6.7	501E-06	7.27	186E-05	7.84	692E-05
0.44	941E-13	1.01	676E-12	1.58	314E-11	2.15	129E-10	2.72	501E-10	3.29	191E-09	3.86	717E-09	4.43	268E-08	5	998E-08	5.57	371E-07	6.14	138E-06	6.71	513E-06	7.28	191E-05	7.85	708E-05
0.45	984E-13	1.02	695E-12	1.59	322E-11	2.16	132E-10	2.73	513E-10	3.3	195E-09	3.87	734E-09	4.44	274E-08	5.01	102E-07	5.58	380E-07	6.15	141E-06	6.72	525E-06	7.29	195E-05	7.86	724E-05
0.46	103E-12	1.03	716E-12	1.6	330E-11	2.17	135E-10	2.74	525E-10	3.31	200E-09	3.88	751E-09	4.45	281E-08	5.02	105E-07	5.59	389E-07	6.16	145E-06	6.73	537E-06	7.3	200E-05	7.87	741E-05
0.47	107E-12	1.04	737E-12	1.61	339E-11	2.18	138E-10	2.75	538E-10	3.32	204E-09	3.89	768E-09	4.46	287E-08	5.03	107E-07	5.6	398E-07	6.17	148E-06	6.74	550E-06	7.31	204E-05	7.88	758E-05
0.48	112E-12	1.05																									

Long distance sniffer probe user manual

This sheet concerns the p/n SNCxExTx long distance sniffer probes.



For all service operations, the long distance sniffer probe should be disconnected from the helium leak detector.

The parts involved are small: be careful not to loose them.

Dimensions Dimensions of the sniffer probe end, for all sniffer probe models.

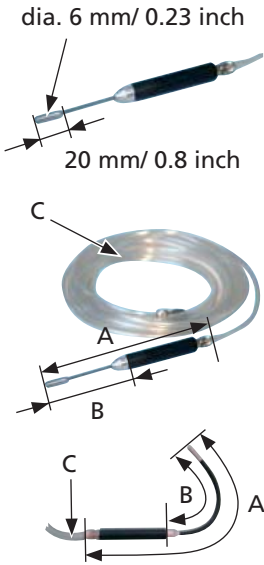

To calculate the complete size of the sniffer probe, add (A) and (C) depending on the sniffer probe model.

Example: sniffer probe p/n SNC1E1T1

$$= \text{gun (A) 19 cm} + \text{tubing (C) 5 m}$$

$$\text{gun (A) 7.5 inch} + \text{tubing (C) 197 inch}$$

End (B)		Sniffer probe part number	Gun (A)
Rigid	9 cm/3.5 inch	SNCxE1Tx	19 cm/7.5 inch
	30 cm/11.8 inch	SNCxE2Tx	40 cm/15.7 inch
Flexible	15 cm/5.9 inch	SNCxE3Tx	25 cm/9.8 inch
	45 cm/17.7 inch	SNCxE4Tx	55 cm/21.6 inch

	Sniffer probe part number	Tubing (C)
PVC flexible (external dia. : 6 mm/0.23 inch)	SNC1ExTx	5 m/197 inch
	SNC2ExTx	10 m/394 inch

Long distance sniffer probe user manual

Technical characteristics

	Sniffer probe with rigid nipple (part number SNCxE1Tx and SNCxE2Tx)	Sniffer probe with flexible nipple (part number SNCxE3Tx and SNCxE4Tx)
Compatibility with leak detectors	All models	All models except ASM 310 and ASM 102 S
Helium concentration in the air	5 ppm	
Maximum flow taken by the probe	60 ± 10 sccm (1 mbar l/s)	≈ 100 sccm
	Note: A flow variation in the sniffer probe does not modify the sensitivity but only the response time. ↗ Flow = ↘ Response time	
Leak flow (Q) read on the leak detector during a measurement of the He in the air without correction factor	$Q = 5 \cdot 10^{-6}$ mbar l/s	$5 \cdot 10^{-6}$ mbar l/s ≤ Q ≤ 10^{-5} mbar l/s
Correction factor (Cor) to apply in order to read a leak flow in the leak detector of $5 \cdot 10^{-6}$ mbar l/s	1	$0.5 \leq \text{Cor} \leq 1$
Note		 Sniffer probe not designed for precise measurements
Working pressure maxi recommended	Atmospheric pressure + 0.5 bar	

Use precautions with the flexible sniffer probe

- Do not step on the probe or flatten it.
- The nipple should not be curved (ref. ①) without respect the instructions below.
- The nipples should not be bent as shown below (ref. ② and ③).

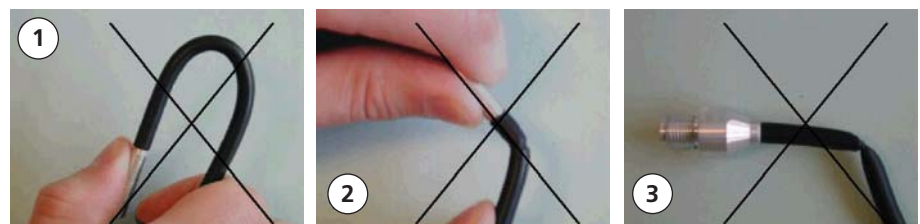

- In case of use with an ASM 142 S, it is necessary to realize a leak detector calibration in sniffing mode before using the leak detector.

Long distance sniffer probe user manual

Use precautions with the flexible sniffer probe (continued)

- The sniffer probe nipple can be bent if necessary but you should respect a **minimum radius of curvature** (ref. ④ and ⑤).

Sniffer probe with a flexible nipple of 15 cm / 5.9 inch (part number SNCxE3Tx)

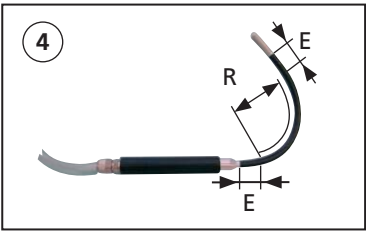

Sniffer probe with a flexible nipple of 45 cm / 17.7 inch (part number SNCxE4Tx)

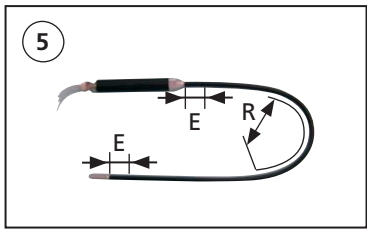

$R > 5 \text{ cm (2 inch)}$ $E > 2 \text{ cm (1 inch)}$: do not twist/bend the E section

Flow adjustment

In order to adjust the flow inside the sniffer probe, it comes equipped with 2 needle types: dia. 0.30 mm (0.11 inch) or 0.35 mm (0.14 inch). This choice is done in factory and it is permanent.

How to identify the needle set in your sniffer probe?

- The needle shape is different:

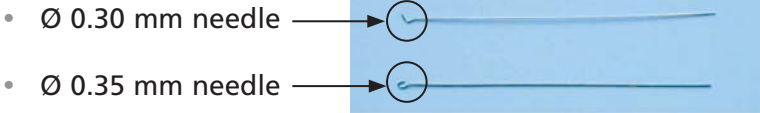

- The sniffer probe nozzle is marked:



Sniffer probe equipped with a dia. 0.30 mm needle has no mark or is marked "0".



Sniffer probe equipped with a dia. 0.35 mm needle is marked "5".

Long distance sniffer probe user manual

Available spare parts

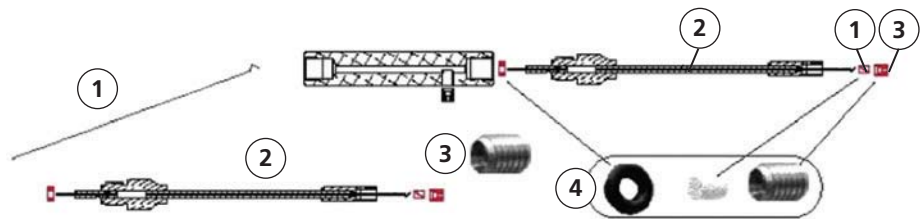

Designation	Reference	
dia. 0.30 mm needle	J 001	1
dia. 0.35 mm needle	J 002	1
Rigid nozzle of 9 cm/3.54 inch (*)	J 003	2
Rigid nozzle of 30 cm/11.81 inch (*)	J 004	
Flexible nozzle of 15 cm/5.90 inch (*)	J 005	
Flexible nozzle of 45 cm/17.71 inch (*)	J 006	
(*) (delivered with the suitable needle not cut)		
Screw alone	J 007	3
Kit for sniffer probe with 5 filters, 2 O'rings and 2 screws	J 008	4

Reference part number F 1000

Filter exchange

- With the 2.5 hexagonal key, remove the screw at the end of the sniffer probe (ref. ①).
- Take out the old filter. Put the new filter in the port (ref. ②).
- Hold this assembly straight up and screw on the nipple of the sniffer probe (ref. ② and ③): torque < 1 N.m
- Install the screw so that it is totally inside the nipple : you should see a few threads (ref. ④ and ⑤).

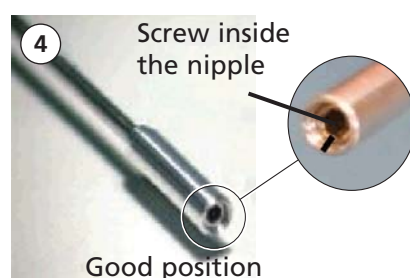
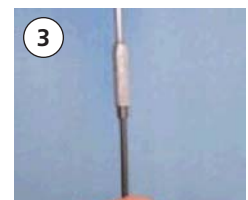
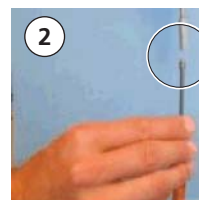
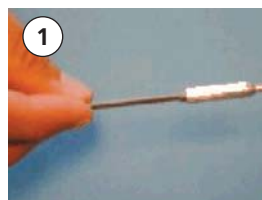

Long distance sniffer probe user manual

Filter exchange (continued)

When you change the filter, we recommend cleaning the needle and the nipple (sniffer probe with rigid nipple only):

- Take out the needle with needlenose pliers.
- Clean delicately the needle with alcohol and a lint-free cloth.
- Clean the rigid nipple with alcohol and compressed dry air.
- Put back the needle.
- Put back the filter with its screw: torque < 1 N.m.

Needle replacement

With this kind of sniffer probe, it is normally not necessary to change the needle.

For every needle replacement in a sniffer probe, put a new needle with the same diameter as the old needle.

3 methods can be used for the new needle adjustment :

- | | | |
|-----------------------------------------------------------------------------------------------------------------------------------|---|---------------------|
| <ul style="list-style-type: none"> ① flowmeter use ② standard sniffer probe use ③ old needle use | } | Recommended methods |
|-----------------------------------------------------------------------------------------------------------------------------------|---|---------------------|

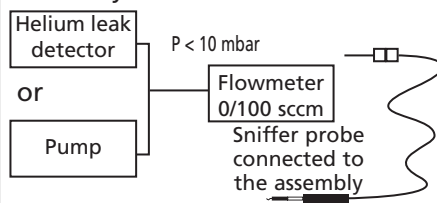
① Flowmeter use in order to measure the flow in the sniffer probe	② Standard sniffer probe use as reference
<p>Assembly to do:</p> 	<p>This method requires keeping a new sniffer probe as a standard probe. Do an auto-calibration in sniffing mode with the standard sniffer probe. Do a measure of the He in the air with the standard sniffer probe.</p>
<p>Cut the new needle to 85 mm/3.35 inch. Prepare it (see below "③ Use of the old needle as a reference", picture ③) and put it correctly in the nozzle (see "Needle exchange" §).</p>	

Long distance sniffer probe user manual

Needle replacement (continued)

① Flowmeter use (cont.)	② Standard sniffer probe use (cont.)
	In a no helium polluted environment, do a measure of the helium in the air with the sniffer probe to adjust.
Depending on the measurement result, cut the needle according to the precautions indicated below. Put back correctly the needle in the nozzle.	
Repeat these operations until the flowmeter displays the value of the maximum flow taken by the sniffer probe (60 ± 2 sccm).	Repeat these operations until the display corresponds to the display with the standard sniffer probe in the helium of the air.
If the message "sniffer probe clogged" appears in the control panel display during these adjustments, please refer to "'Sniffer probe clogged" message" §.	

Precautions to cut the needle.

It is necessary to cut small amounts of the needle, especially when we are near the target value: refer to the figure below.

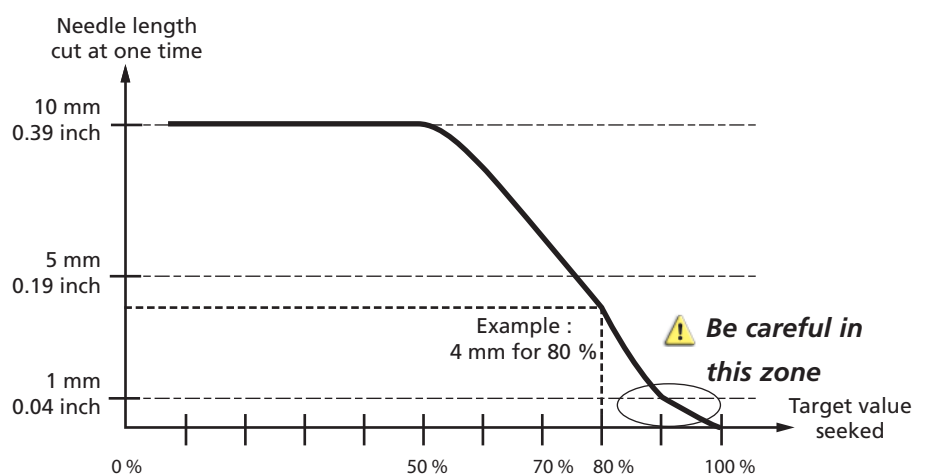

Example: • target value = 60 sccm

- value displayed on the flowmeter : 48 sccm (= 80 % of the target value)

➔ remove the needle from the nozzle and cut 4 mm from the straight end.

③ Use of the old needle as a reference

With this method, the uncertainty about the maximum flow taken by the sniffer probe is more important :

- Maximum flow taken: 60 ± 10 SCCM
- Leak flow (Q): $4 \cdot 10^{-6}$ mbar l/s < Q < $6 \cdot 10^{-6}$ mbar l/s.

Take out the filter (see "Filter exchange" §).

Long distance sniffer probe user manual

Needle replacement (continued)

With needlenose pliers, take out the original needle.

Put the new needle (ref. ①) and cut to **the same length** as the original needle.

Note:

For the flexible sniffer probe (SNCxE3Tx and SNCxE4Tx), the needle length should be 2.5 cm/0.98 inch (ref. ②).

Bend the needle as shown in the picture ③.

Put the needle in the nipple, the crooked end to outside (ref. ④) and push it in with a 2.5 hexagonal key to stop.

Put back the filter.

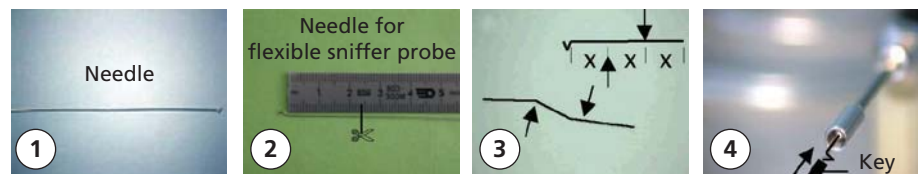

O'ring installation

- When you unscrew the nipple from the probe, it is possible for the o'ring to come out with the nipple : you should put it back (ref. ①).
- Place the o'ring on the nipple of the aspiration tube in the sniffer body (ref. ②).
- Push the o'ring with the nipple of the sniffer probe (ref. ③).
- The o'ring is correctly placed on the nipple (ref. ④).
- Screw on the nipple of the sniffer probe.

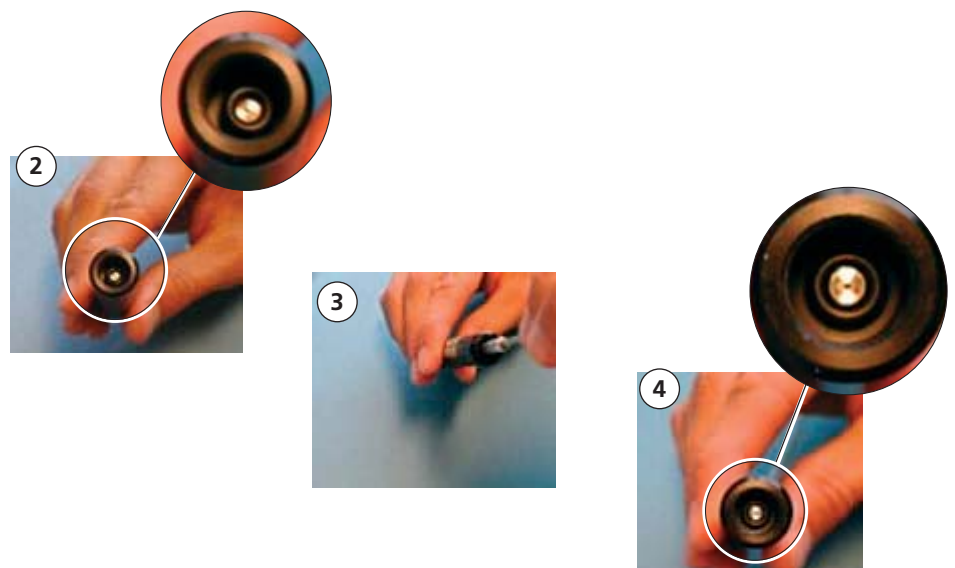
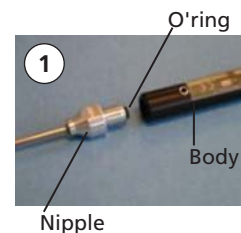

Long distance sniffer probe user manual

"Sniffer probe clogged" message

A "Sniffer probe clogged" message could appear on the control panel LCD display or be announced by the digital voice: the leak detector compares the helium signal read on the detector to the sniffer probe clogged reject threshold.

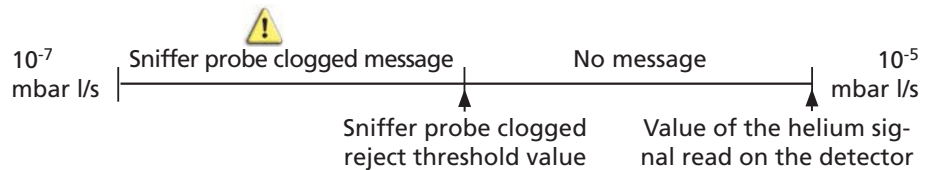

During the needle adjustment, this message could appear without the sniffer probe necessarily being clogged: this is why the needle length is so important.

For more details, please consult the operating manual delivered with your leak detector.

Advice:

Block the sniffer probe end from time to time with a finger to check that the helium signal goes down. If not, the sniffer probe may be clogged.

Adaptor for calibrated leak

Description	P/N
Adaptor for DN 16 calibrated leak	A 006
Adaptor for DN 25 calibrated leak	A 007

Reference part number  F 1000



Special adaptors for calibrated leaks Pfeiffer Vacuum have been designed to ensure a good connection and repetitive and reliable calibration with a sniffer probe.

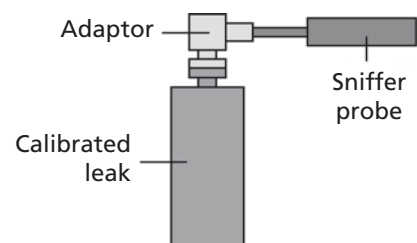

With the adaptor for calibrated leaks use:

$$\text{Value read on the leak detector} = \left\{ \begin{array}{l} \text{calibrated leak value} \\ + \\ \text{value of the helium in the air} \end{array} \right.$$

Helium spray gun user manual

Description

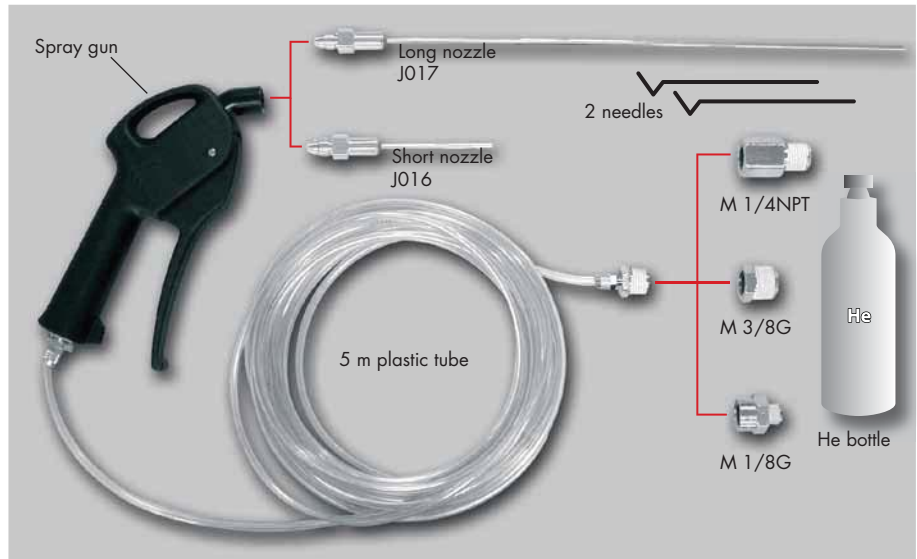

Kit part number  **A**

Technical characteristics

Maximum pressure at the outlet of the helium bottle regulator	3 Bars relative / 42 PSI
Recommended pressure at the outlet of the helium bottle regulator	1.5 Bar relative / 7 PSI

	short end				long end			
	needle		regulator pressure	flow	needle		regulator pressure	flow
	used	length			used	length		
rough and fast detection	no		0.5 / 1 bar	> 1000 ml/mn	no		0.5 / 1 bar	> 500 ml/mn
highly specialized detection	yes	80 mm	0.5 bar	60 ml/min	yes	175 mm	0.5 bar	60 ml/min

Helium spray gun user manual

Use precaution It is possible to reduce the flow: put the needle as show on the picture and cut if necessary.

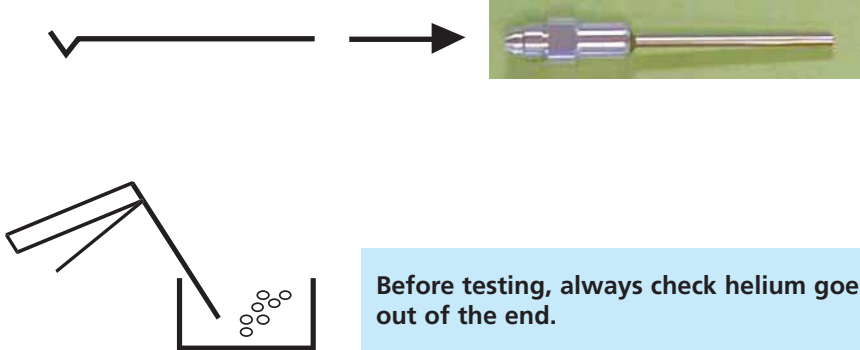

Spare parts

Description	Reference
Long end	J 017
Short end	J 016
Needle	J 001

Reference part number  F 1000

Service

Pfeiffer Vacuum offers first-class customer service!

- On-Site maintenance for many products)
- Overhaul / repair in the nearby Service Location
- Fast replacement with refurbished exchange products in mint condition
- Advice on the most cost-efficient and quickest solution

Detailed information, addresses and forms at: www.pfeiffer-vacuum.com (Service).

Overhaul and repair in the Pfeiffer Vacuum Service Center

The following general recommendations will ensure a fast, smooth servicing process:

- Fill out the «Service Request/Product return» form and send it to your local Pfeiffer Vacuum Service contact.
- Include the confirmation on the service request from Pfeiffer Vacuum with your shipment.
- Fill out the declaration of contamination and include it in the shipment (mandatory!). The Declaration of contamination is valid for any product/device including a part exposed to vacuum.
- Dismantle all accessories and keep them.
- Close all the ports flange openings by using the original protective covers or metallic airtight blank flanges for contaminated devices.
- If possible, send pump or unit in its original packaging.

Sending of contaminated pumps or devices

No devices will be accepted if they are contaminated with micro-biological, explosive or radioactive substances. "Hazardous substances" are substances and compounds in accordance with the hazardous goods regulations (current version).

- Neutralize the pump by flushing it with nitrogen or dry air.
- Close all openings airtight.
- Seal the pump or device in suitable protective film.
- Return the pump/device only in a suitable and sturdy transport container and send it in while following applicable transport conditions.

Pump or device returned without declaration of contamination form fully completed and/or non-secured in a suitable packaging, will be decontaminated and/or returned at the shipper's expense.

Exchange or repaired devices

The factory operating parameters are always preset with exchange or repaired devices. If you use specific parameters for your application, you have to set these again.

Service orders

All service orders are carried out exclusively according to our general terms and conditions for the repair and maintenance, available in our website.

Tools

ASM View supervisory Software **2/7**

Presentation

ASM Downloader software **3/7**

Presentation
Detectors concerned

ADX Dialog (Detection) software **6/7**

Presentation
Interface (main functions)
Use

Software are free. To load the latest software version, go on our website www.pfeiffer-vacuum.com

[Info center](#) → [Download Center](#) → [Category "Software"](#)

Tools

ASM View supervisory
software

Presentation

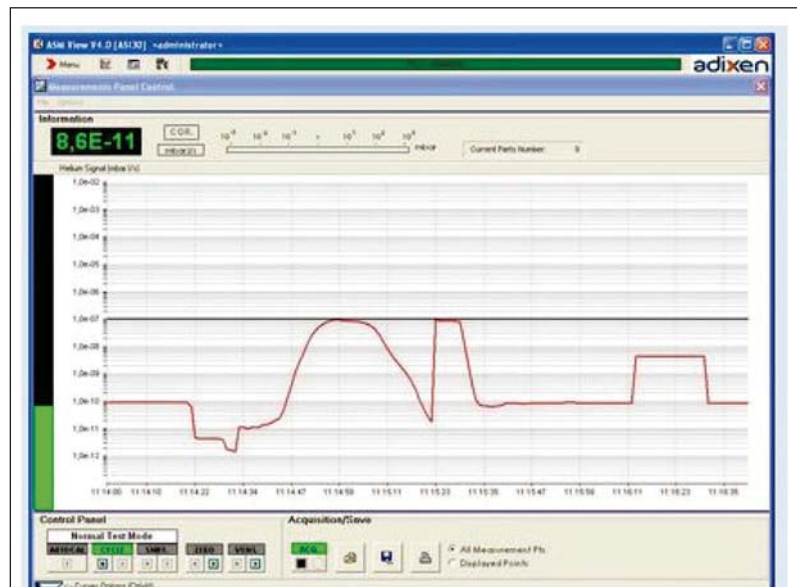

Software for data acquisition, storage and graphical display to be used with all Helium Leak Detectors

The **ASM View** software allows you to control, display and save data through a PC from any Adixen Helium Leak detector. Whatever your application ASM View provides a wide range of possibilities, several windows are available. The Measurement window is designed to collect the leak detector information in real time: helium signal, inlet pressure and detector status.

The Part Test window is designed to display on the graphic the information of the leak detector when the cycle is stopped (transition Cycle -> Stand by). The Detector Parameters window allows the adjustments of the leak detector parameters. You have the possibility of modifying them, then applying them to the leak detector with the corresponding button. You can also save these parameters in a file and then download the saved parameters in the leak detector. You can also access all the software events, the detector faults and its status changes thanks to the Archive window.

Requirements:

PC : 500 MHz, 128 Mb RAM, 50 Mb hard drive, Graphic card
1024x768x256 colors

Operating system: Windows 2000, Windows XP, Windows Vista

Download tool :

ASM View v4.0.5

Download

Tools

ASM Downloader software

Presentation



Software to download inboard recorded data from Adixen Helium Leak Detectors equipped with the color graph display.

Your Adixen Helium leak Detector is equipped with a touch screen graphic color display. With the ASM Downloader software, you can visualize and record the evolution of the helium signal, the inlet pressure and set points via color graphs. Further, you can enjoy the touch panel for quicker parameter settings, check the pressure inside the mass spectrometer or follow the status of the leak detector main components by enjoying the dynamic vacuum diagram.

Simply connect your computer to the leak detector using the specific interface (RJ9/9pin Sub-D) cable delivered with the detector and thanks to ASM Downloader, download up to 900 hours of memorized leak detection data.

Requirements:

- Helium leak detector equipped with a Graph interface
- PC : 500 MHz, 128 Mb RAM, 50 Mb hard drive, Graphic card 800x600x256 colors. Operating system: Windows 2000, Windows XP, Windows Vista

Download tool :

ASM Downloader v2.0.0 [Download](#)

Detectors concerned

- ASM Graph - ASM Graph D - ASM Graph D+
- ASM 182 T and ASM 182 TD+ equipped with "Tactil interface operator" option.

Tools

ADX Dialog software (Detection)

Presentation

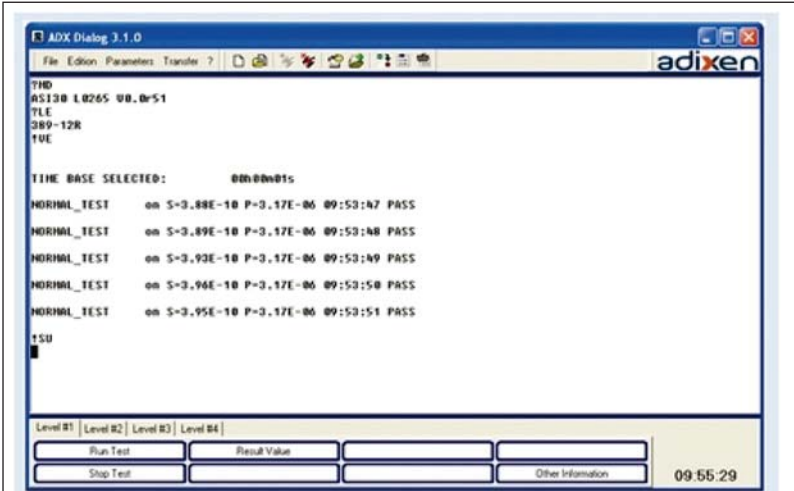

Communication with products having a serial communication interface

ADX Dialog is an easy to use terminal program for your Windows® PC to communicate with all products having an RS232 serial interface: the ideal little tool to test a new vacuum pressure measurement installation or a leak test bench. It runs without installation.

The ADX Dialog software comes along with a set of configuration files for use with Adixen helium leak detectors (and Adixen Series 2000 gauge controllers). These files can be modified to your needs and stored on your PC.

Just open the appropriate file, connect the RS232 interface of your ACS2000 or ACM2000 controllers to your computer by a standard 9pin Sub-D cable (transmitting and receiving wires crossed) and send your commands and requests by pushing the pre-programmed function keys. If your computer has no RS232 interface please use a RS232-to-USB adapter, available from your local computer shop (e.g. ATEN UC-232A). Commands can also be keyed in as text. The complete communication can be stored for further use.

ADX Dialog works also with RS485 gauges (appropriate RS232/RS485 or USB/RS485 adapter necessary).

Requirements:

PC 500 MHz, 128 MB RAM, 50 MB hard drive, Graphic card 1024x768x256 colors
Operating system: Windows 2000, Windows XP, Windows Vista

Download tool :

ADX Dialog v3.1.0 [Download](#)

Tools

Interface (main functions)

Port closing
Port opening
Terminal parameters setting
Function keys setting
Communication parameters setting

4 levels available
(1 level = 1 function keys package)
Function keys set in the selected level

Tools

ADX Dialog software (Detection) (ctd)

Use 1 - Set the communication parameters

ASM Dialogue communication parameters set are the same as the leak detector communication parameters defined in the RS 232 operating manual (chapter C).

If you change leak detector values ("Baud rate" for example), you must change also the ASM Dialogue values

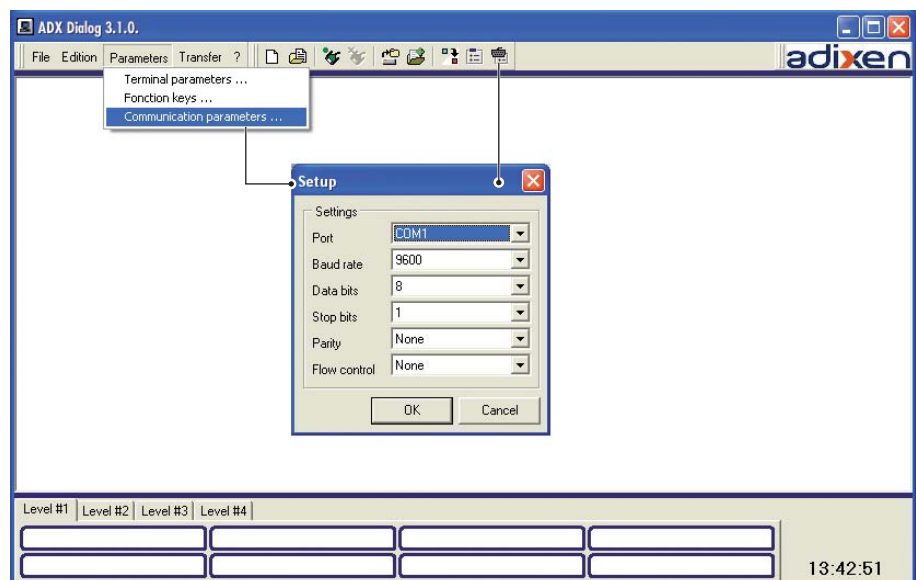

2 - Set the Terminal parameters

Optional.

Tools

Use (ctd) 3 - Define Function keys
Optional.

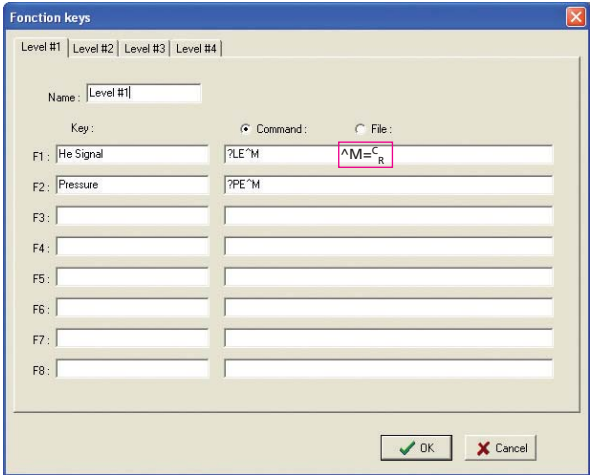

4 - Open the port

5 - Write the command and press a carriage return for the answer
(or select a function key).

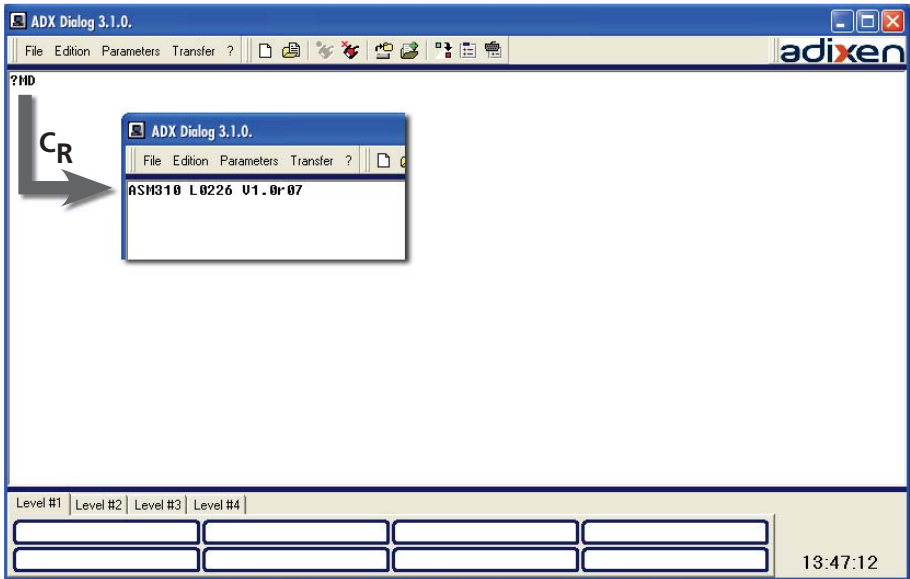

VACUUM SOLUTIONS FROM A SINGLE SOURCE

Pfeiffer Vacuum stands for innovative and custom vacuum solutions worldwide, technological perfection, competent advice and reliable service.

COMPLETE RANGE OF PRODUCTS

From a single component to complex systems:

We are the only supplier of vacuum technology that provides a complete product portfolio.

COMPETENCE IN THEORY AND PRACTICE

Benefit from our know-how and our portfolio of training opportunities!

We support you with your plant layout and provide first-class on-site service worldwide.

Ed 07 - Date 2016/04 - P/N:109438EN



Are you looking for a
perfect vacuum solution?
Please contact us:

Pfeiffer Vacuum GmbH
Headquarters • Germany
T +49 6441 802-0
info@pfeiffer-vacuum.de

www.pfeiffer-vacuum.com

PFEIFFER  **VACUUM**