

THE NEW
PORTA-TEST™
HELIUM LEAK DETECTOR
938-41

...light, portable, easy to operate

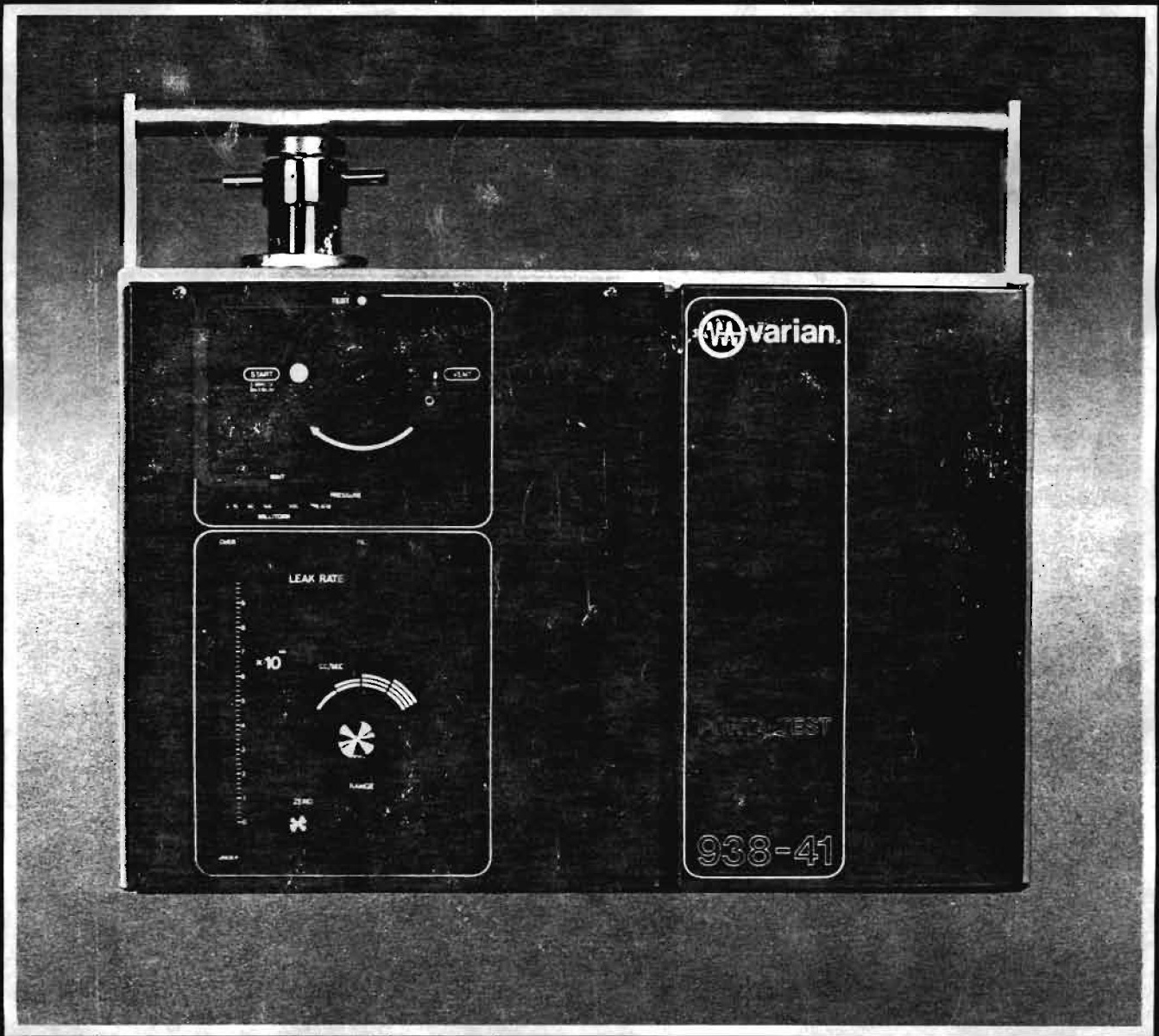

**ANOTHER NEW DIMENSION
IN LEAK DETECTION
FROM VARIAN**

**FEATURING THE...
938-41 PORTA-TEST™
helium leak detector**

**A MAJOR ENGINEERING ACHIEVEMENT
AT A PRICE YOU CAN AFFORD**

- HIGH SENSITIVITY TESTING AT HIGH TEST PORT PRESSURES**
Contra-Flow™ design allows small leaks to be detected without throttling
- LOW OPERATING COSTS**
No liquid nitrogen required
- EASY TO OPERATE**
Operation is controlled by rotation of only one handle through the operating cycle positions
- EASY TO READ AND INTERPRET LEAK RATE**
50 segment, direct readout LED bar graph display with digital exponents...capable of reading leaks in the 10^3 to 10^{10} atm cc/sec. range (helium)
- LIGHT AND PORTABLE**
Only 50 pounds in a compact, well-integrated package
- EASY TO UNDERSTAND AND OPERATE TUNING AND CALIBRATION CONTROLS**
Residual background switch
- EASY TO MAINTAIN**
Modular construction...Entire vacuum system held in place by 4 bolts
- SAFE OPERATION**
Diffusion pump thermostat offers full protection against catastrophic failures
- EASY TRAVEL AND OPERATOR CONVENIENCE**
Optional mobile cart...Optional drawer on cart provides a safe and convenient place for storing probes, tools, calibrated leaks, etc.

The more you demand of your leak detector, the more you need the 938-41. It's the best and most complete leak detector you can buy.

ADDITIONAL BENEFITS

Handles high gas load without throttling. The leak detector sees all of the gas load, not just a tiny fraction.

No liquid nitrogen required. The 938-41 is not equipped with a cold trap. It is truly a trapless unit.

Proven reliability. Several thousand Varian leak detectors employing the proven Contra-Flow™ principle are currently being used in a variety of applications.

Manual test cycle sequenced for protected operation.

Unique valve block design mechanically positions valves properly during the test cycle. Improper sequencing is thus prevented and mistakes minimized.

The diffusion pump is designed to take maximum advantage of Varian's patented Contra-Flow™ principle.

Flexibility. Optional roughing manifold has a 360° rotating elbow termination to allow the mechanical pump to be hooked up to the 938-41 leak detector at all angles.

Varian's 938-41 leak detector also offers:

- Protection against A-C line voltage variations
- Rugged electronic components used throughout
- Computer-optimized, temperature-stabilized, solid-state pre-amp assembly.

These features ensure higher sensitivity, optimum reliability, and stable operation.

THE CONTRA-FLOW™ PRINCIPLE*

The 938-41 leak detector design is based on the Contra-Flow™ principle — a proven technique that takes advantage of the differences in maximum pressure ratios** produced by the diffusion pump for gases of different molecular weights. For example, the maximum pressure ratio for helium may be 10 or 100, while for oxygen and other gases contained in air, the ratios are normally far in excess of 1 million.

This principle is implemented in the 938-41 leak detector by introducing helium (and other inlet gases such as those resulting from a leak in the test piece) into the diffusion pump foreline rather than into the "normal" pump inlet as in conventional leak detectors. Helium, having a much lower pressure ratio than other gases contained in air, diffuses backwards through the diffusion pump to reach the sensing tube where it is detected as a leak in the normal manner. Although the mechanical pump is also attached to the diffusion pump foreline and removes all inlet gases, including helium, there is no appreciable loss of sensitivity in the 938-41 leak detector.

*U. S. Patent No. 3,690,151

**The pressure ratio is the exhaust pressure in the foreline divided by the inlet pressure.

938-41 PORTA-TEST™ LEAK DETECTOR

Portability, operational simplicity, and a number of unique design features are the main attractions of the 938-41. The single, self-contained unit can be moved quickly and conveniently around an electronics or industrial plant to test individual systems or production parts. The unit is ideally suited for detecting leaks in large vacuum systems where access is difficult, such as coaters, furnaces, electron beam welders, distillation towers and power plant steam condensers.

The 938-41 operates with just a single handle to position valves for proper sequencing. The unit requires no liquid nitrogen and can handle high gas loads (up to 1 atm. cc/sec.) and measure gross leaks without throttling.

The heart of the 938-41 is a helium sensing tube, which generates an electrical output proportional to the amount of helium in the system. Amplified, this output is displayed on the leak rate bar graph. The helium sensing tube plays the major role in determining the sensitivity, reliability, and maintenance ease of the 938-41.

Varian's ingenious Contra-Flow™ design in the leak detector filters out unwanted gases and buffers the sensing tube against pressure bursts. This patented technique explains why the 938-41 is so efficient in coping with heavy loads of gas and gross leaks that challenge other models.

Advantages of the Contra-Flow™ principle include the elimination of liquid nitrogen, thus saving cost and removing a hazardous material. In addition, pumping times are reduced, as tests can be made at test port pressures as high as 350 milliTorr without adverse effects on the diffusion pump. Since high-pressure tests can be conducted without throttling, smaller leaks can be found. Particular advantages are achieved when testing large systems that cannot be evacuated to low pressures.

MINIMUM DETECTABLE LEAK
2 x 10⁻¹⁰ atm. cc/sec. (helium)
8 x 10⁻¹¹ atm. cc/sec. (air)

BENCH MODEL WITH MANIFOLD AND MECHANICAL PUMP

A bench model of the 938-41 is available for applications in which the leak detector need not be moved to different locations. The leak detector is placed in one location (e.g., on a work bench, wall shelf, etc.) for permanent use. A mechanical pump and appropriate manifolding are supplied with this model. Maximum table-top height is 36 inches.

COMPACT CART MODEL

The cart-mounted version of the 938-41 Porta-Test™ Leak Detector is designed for easy travel and operator convenience. The support frame is a sturdy, welded, metal unit with 8-inch diameter semi-pneumatic wheels for ease of mobility. The mechanical pump and leak detector both plug into the cart.

The cart model may be purchased with an optional and convenient drawer for storing probes, tools, calibrated leaks, and accessories.

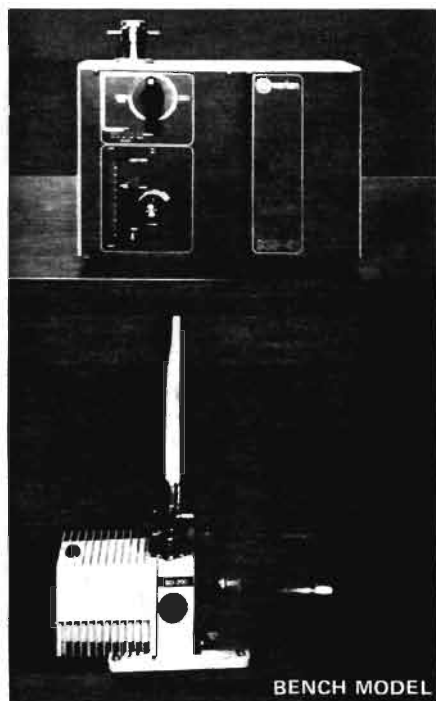

BENCH MODEL



BASIC UNIT

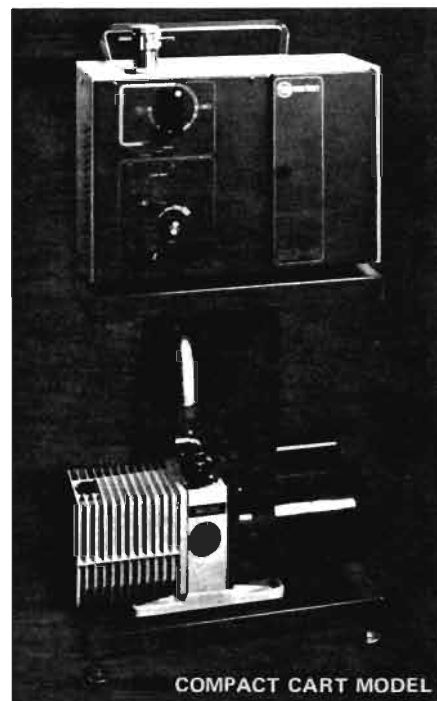

COMPACT CART MODEL

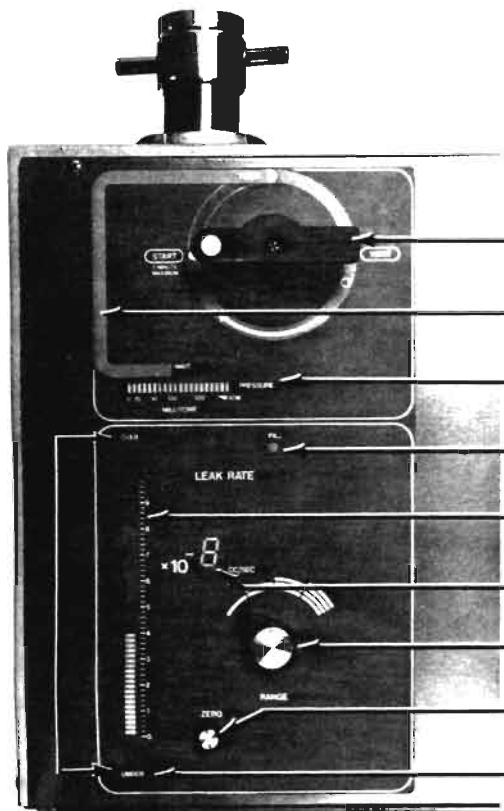

- SINGLE CYCLE CONTROL HANDLE FOR SIMPLE OPERATION
- COLOR CODED MODE IDENTIFICATION
- TEST PORT PRESSURE DISPLAY
- FILAMENT STATUS LIGHT
- LEAK RATE DISPLAY
- DIGITAL RANGE EXPONENT
- LEAK RATE RANGE SELECTOR
- ZERO ADJUST
- OVER – UNDER RANGE STATUS INDICATORS

OPERATION

The object to be tested is connected to the test port and evacuated. Helium entering through a leak diffuses instantly into the foreline of the specially designed diffusion pump. A constant pressure ratio is maintained between the foreline and sensing tube which measures the amount of helium in the system and converts it into an electrical signal.

The signal is measured by the leak rate bar graph display and quantified. When the helium source is removed from the leak, the helium remaining in the system is rapidly pumped away.

Thus the effect is a rise and fall of the leak rate bar graph indication.

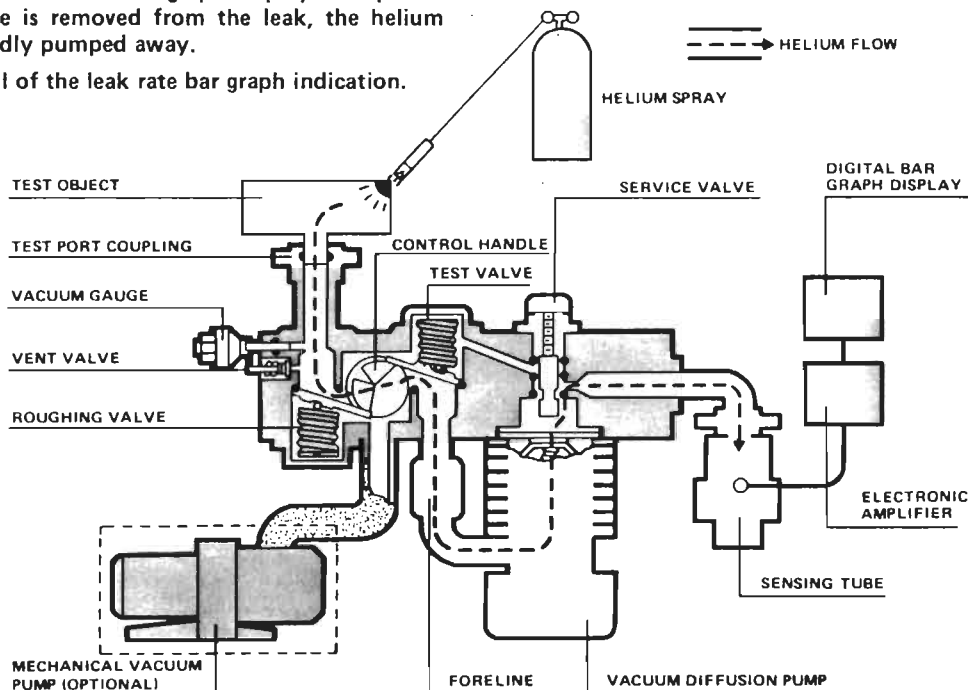

938-41 LEAK DETECTOR FLOW DIAGRAM

938-41 PORTA-TEST APPLICATIONS

Field Service Maintenance of Vacuum Systems of all types:

Metallizers, thin film evaporators, electron beam microscopes, electron beam welders, space simulation chambers, tube processing stations, linear accelerators, freeze dryers, coaters and ion implanters.

Vacuum Furnaces, all types:

Melting, sintering, annealing, degassing, heat treating and brazing.

University laboratory equipment
Power plant steam condenser systems

Cryogenic piping

Vacuum distillation towers

Sealed systems of all types

A wide variety of production parts

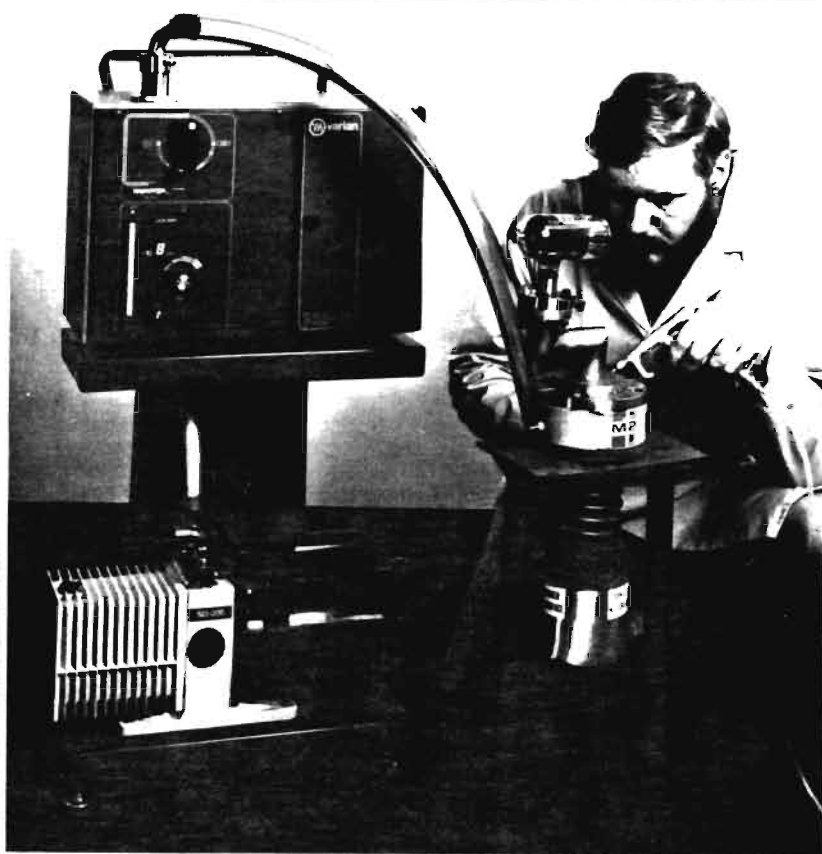
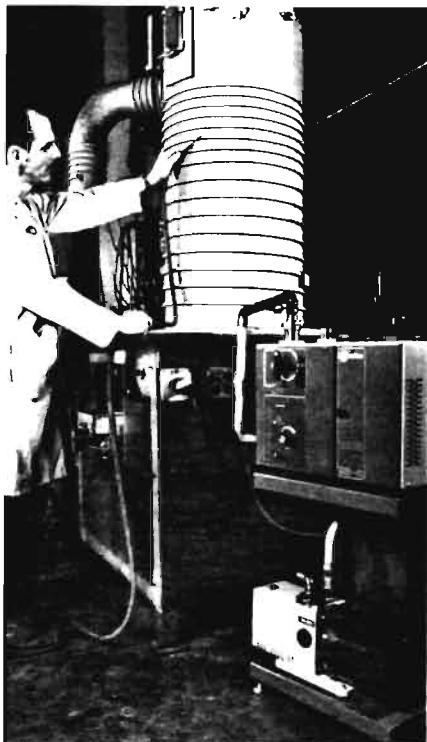
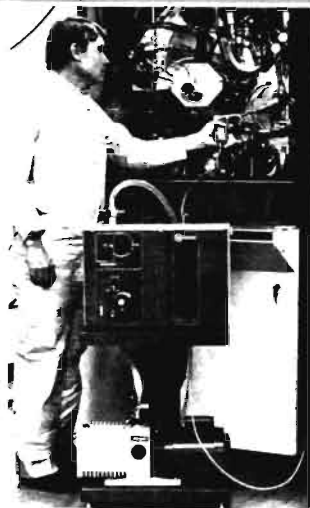

TYPICAL INDUSTRIES SERVED

Nuclear
Aerospace
Medical Electronics

Refrigeration & Air-Conditioning
Chemical Plants & Refineries
Semiconductor—Electronic

Automotive
Packaging—Food/Drug
Research & Development



SPECIFICATIONS

MINIMUM DETECTABLE SIGNAL/SENSITIVITY IN ACCORDANCE WITH AVS STANDARD 2.1:

2×10^{-10} atm cc/sec range
(helium)

8×10^{-10} atm cc/sec (air)

NOTE: 938-41 sensitivity is influenced by the speed of the system's mechanical pump. The above specifications are obtained with a nominal 7 CFM pump. Minimum detectable signal is registered as one segment when tuned for direct readout on the lowest leak rate range.

RESPONSE TIME

2 seconds for helium in accordance with AVS Standard 2.1.

CUSTOMER SUPPORT

When you buy Varian, you buy more than a product. You know there's a dedicated and well trained service team to back you up. Varian's Industrial Products Service Operation has the largest staff of Field Service Specialists in the industry at strategic locations around the United States. Our service staff is on call 24 hours a day to assure prompt service. An extensive inventory of spare parts is stocked in our service depot for immediate use.

Varian's Vacuum Training Department offers a wide range of maintenance and operation courses to users of leak detectors and other vacuum-related equipment. These courses are given regularly on both coasts of the United States—Palo Alto, California, and Lexington, Massachusetts.

AMPLIFIER DRIFT

Less than 2% of most sensitive scale in accordance with AVS Standard 2.1.

NOISE LEVEL

Less than 2% of full scale, peak-to-peak, in accordance with AVS Standard 2.1.

LEAK INDICATOR

50-segment bar graph. Three sets of direct reading sensitivity ranges comprised of four decades in each range:

10^{-9} to 10^{-6}

10^{-8} to 10^{-5}

10^{-7} to 10^{-4}

RECORDER JACK

0-5 VDC

AUDIO ALARM

Provided with volume control and output jack for remote speaker.

SENSING TUBE

Programmed heating of the entire sensing tube during start-up. Pre-amplifier is a computer-optimized, temperature-stabilized, solid-state device, and is located in the vacuum enclosure. Demountable pole pieces for quick access to the tube interior. The entire tube can be quickly removed for maintenance by the use of a KF flange. Patented dual-filament, disposable, all-welded ion source. Patented integral cold-cathode gauge keeps the source clean. Removable magnet structure for easy cleaning.

DIFFUSION PUMP

90ℓ/s stainless, air-cooled pump developed for the leak detector application. This pump is designed for stable pressure ratio performance for helium. Uses oxidation-

resistant polyphenyl fluid and is equipped with an optically dense baffle for maintaining system cleanliness.

MANUAL VALVES

O-ring sealed, spring-loaded (75 lb. force), cam-operated roughing and foreline valves incorporated into a valve block design that insures their proper sequencing.

VACUUM GAUGES

Cold cathode gauge measures high vacuum in the 1 milli Torr to 10^{-5} range in the analyzer tube. Thermocouple gauge in port manifold monitors the roughing and test pressure.

TEST PORT

1-1/8" ID quick coupling is provided.

POWER REQUIREMENTS

120V (220V) 50/60 Hz single-phase power

5 (2.5) amps

10 (5) amps with 7 CFM pump

15 (7.5) amps with 11 CFM pump

Optional 220V 50/60 Hz single phase

CABINET

8 x 13-1/2 x 19-1/2-inch cabinet with a hinged door provides easy access to vacuum assembly and electronics.

WEIGHT

50 lbs. (approx.)

Shipping weight--60 lbs. (approx.)

SPARES

One ion source, two discharge gauge liners, and an instruction manual are provided with each unit.



Varian's Leak Detector Manufacturing Facility
Lexington, Mass.

938-41 ACCESSORIES AND SPARES

HELIUM SPRAY PROBE

In order to locate leaks when the 938-41 leak detector is used to evacuate the test piece, it is necessary to have a controlled source of helium so that the helium can be directed at the point of leakage in small quantities. The spray probe used for this procedure consists of a pistol grip and 10 feet of flexible hose connected to a regulated helium supply, a spring close valve, and three different nozzles:

1. A hypodermic nozzle for pin-pointing leaks
2. A flexible tubing nozzle for hard-to-reach areas
3. A long, soft copper nozzle which can be bent into almost any configuration to reach into deep crevices.

Order Number: 0981-K0167-301



POWER PROBE/SNIFFER PROBE

A completely adjustable sniffer probe is available for tests involving varying sensitivities and response times. This probe may be used with different size mechanical pumps. It is extremely rugged and can be disassembled for cleaning. The probe resists clogging, and can be unclogged easily.

Order Number: 0991-K9565-301



O-RING KIT

Includes one each of every O-ring used in the 938-41, plus extras.

Order Number: 0981-K7641-801

SPARE PARTS KIT

Including the following: Mechanical pump and diffusion pump fluids, TC gauge tube, ion source, O-ring kit and miscellaneous parts for pressure gauge.

Order Number: 0981-K7642-801

OPTIONAL DRAWER FOR CART MODEL

For the convenience of the user, an optional drawer is available with the cart model version of the 938-41. This drawer is ideal for storing probes, tools, calibrated leaks, etc.

Order Number: 0981-K9597-301

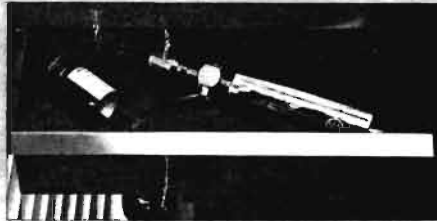

TUNING LEAK

For calibrating, the tuning leak can be adjusted to allow sufficient ambient air into the 938-41 leak detector inlet port so that the trace amount of helium in the air may be used to tune the leak detector. With this leak open, the mechanical pump maintains vacuum levels of 10-to-300 milli Torr. The tuning leak takes advantage of the helium in the air to tune the leak detector. It is also useful for checking that the various functions of the leak detector are operating correctly. In a well ventilated room, a response equal to 5×10^{-6} std. cc/sec helium is indicated on the bar graph display.

Order Number: 0991-K1608-301



CALIBRATION LEAKS

When the leak detector must be calibrated to size unknown leaks, a calibration leak can be used after or in place of the tuning leak.

Two types are available: calibrated leaks with a helium reservoir and shut-off valve (10^{-7} std. cc/sec. range sufficient for most applications); and capillary leaks of various sizes (helium supplied by user).

Order Numbers

Calibrated Leak with Helium Reservoir:

10^{-7} std cc/sec range —

0981-F8473-301

10^{-8} std. cc/sec. range —

0981-F8473-302



SYSTEM-TO-DETECTOR COUPLING KIT

A system-to-detector coupling kit allows simple connection of the leak detector to a vacuum system through 6-feet of copper tubing. It consists of a valve and adapter that remain on the system. A quick disconnect allows attachment of the leak detector. When vacuum is reached on both sides of the valve, the valve is opened and the test can commence. It is typically placed on the foreline of the diffusion pump.

Coupling Kit: 0991-K7954-301

System Coupling Valve: 0991-K7953-301

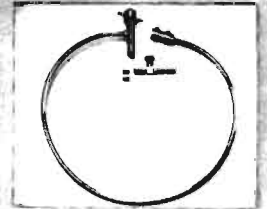

TRAVELING CASE

An optional, rugged, and durable traveling case is available for transporting the 938-41 Porta-test from one site to another. This case has a foamlined interior, recessed wheels, and pull handles.

Order Number: 0981-6999-09-053

LEAK DETECTION LITERATURE Additional Operator/Maintenance Manual.

Order Number: 0981-6999-09-510

Optional Service Manual

Order Number: 0981-6999-09-515

Leak Detection Handbook

Order Number: 0981-6999-09-070

The 135-page handbook *Introduction to Helium Mass Spectrometer Leak Detection* is useful for experts and novices. It covers leak detection fundamentals, helium leak detector types and components, equipment tuning and calibration, and product fixture and design.

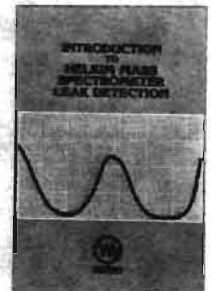

Training and Service

Training and preventive maintenance contracts are available for the user of any 938-41 leak detector. Further details are available from your nearest Varian Industrial Products Operations District Office.

ORDERING INFORMATION

ORDER NUMBER

938-41 Porta-Test [™] Helium Leak Detector <i>Basic Unit</i> - Includes audio alarm, one spare ion source, two spare pressure gauge liners, and one instruction manual	0938-K9500-301
938-41 Porta-Test [™] Helium Leak Detector <i>Bench Model</i> - Includes basic unit and unmounted mechanical pump and manifolding. Either 7 CFM or 11 CFM mechanical pump is available. Bench model with 7 CFM mechanical pump	0938-K9550-321
Bench model with 11 CFM mechanical pump	0938-K9550-322
938-41 Porta-Test [™] Helium Leak Detector <i>Cart Model</i> - Includes basic unit installed on a roll-around cart complete with mechanical pump, manifolding, and all electrical assemblies. Either a 7 CFM or an 11 CFM mechanical pump is available. Cart model with 7 CFM mechanical pump	0938-K9550-301
Cart model with 11 CFM mechanical pump	0938-K9550-302
Optional drawer for cart	0981-K9597-301
Stand-alone cart with electrical fixtures	0981-K9598-301
NOTE: When purchasing a basic unit, the roughing manifold stub terminates with a straight 1" tubulation. The following two optional roughing manifold terminations are available:	
Roughing manifold stub with NW 25 KF flange assembly	0981-K9535-301
Roughing manifold stub with 360° rotating elbow option	0981-K9533-301
Traveling case for 938-41 leak detector with foam-lined interior, recessed wheels, and pull handles	0981-6999-09-053

INSTALLATION

Included in the purchase price of your 938-41 Leak Detector are installation, operational checkout, and operating instructions, provided by a qualified Varian engineer. Varian can provide additional in-depth maintenance training and schooling on request, at the customer's expense.

HOW TO ORDER

Orders or requests for additional information should be directed to your nearest Varian Industrial Products Regional Center:

NORTHERN REGION

CHICAGO

Varian
708 Landwehr Road
Northbrook, IL 60062
Phone: (312) 480-0300

EASTERN REGION

BOSTON

Varian
331 Montvale Avenue
Woburn, MA 01801
Phone: (617) 935-5185

SOUTHERN REGION

ALBUQUERQUE

Varian
2651-E Pan American Frwy., N.E.
Albuquerque, NM 87107
Phone: (505) 344-8807

WESTERN REGION

SAN FRANCISCO

Varian
645 Clyde Avenue
Mountain View, CA 94303
Phone: (415) 964-2790

CUSTOMER SERVICE

FOR SERVICE — PLEASE CALL

**VARIAN IPO SERVICE DEPOT, 645 Clyde Avenue
Mountain View, CA 94043, Phone: (415) 964-2790
Phone: Nat: (800) 227-9722 CA: (800) 982-6185 — 24 Hrs. a Day**



varian

VARIAN/LEXINGTON VACUUM DIVISION

121 HARTWELL AVENUE/LEXINGTON, MA 02173
TELEPHONE: (617) 861-7200

VARIAN 938-41 PORTA-TEST LEAK DETECTOR

OPERATOR/MAINTENANCE MANUAL

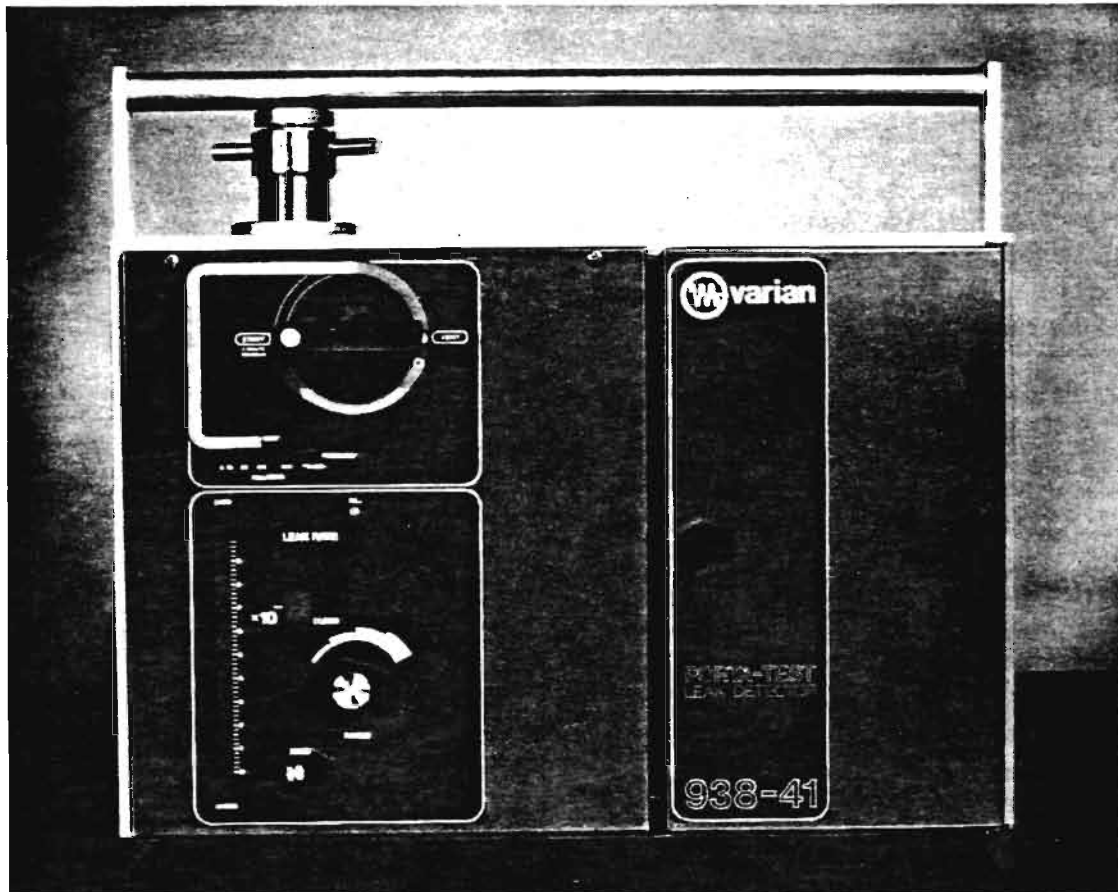

varian/lexington vacuum division / 121 hartwell avenue/lexington/massachusetts 02173

ISSUE 1
MARCH 1983
MANUAL P/N: 0981-6999-09-510

Warranty — Standard Products

Varian warrants each standard Product manufactured and sold by it to be free of defects in materials and workmanship for such period of time and under such conditions as are specified herein or as may be specified by Varian on the face of its quotation or otherwise reduced to writing and expressly approved by Varian. The warranty period so specified by Varian shall commence on the date of delivery from Varian to the original purchaser. The warranty period shall commence on the date of delivery from Varian to the original purchaser and extend for one (1) year. If no period of time is stated, then Varian's warranty for standard Products is limited to one (1) year from the date of delivery.

Repair, or at Varian's option, replacement of defective parts shall be the sole and exclusive remedy under warranty, provided that, Varian may, as an alternative, elect to refund an equitable portion of the purchase price of the Product. Items expendable in normal use are not covered by this warranty. All warranty replacement or repair of parts shall be limited to Product malfunctions which, in the sole opinion of Varian, are due or traceable to defects in original materials or workmanship. All obligations of Varian under this warranty shall cease in the event of abuse, accident, alteration, misuse or neglect of the Product. In-warranty repaired or replacement parts are warranted only for the remaining un-expired portion of the original warranty period applicable to the repaired or replaced parts. After expiration of the applicable warranty period, Customer shall be charged at the then current prices for parts, labor, and transportation.

Reasonable care must be used to avoid hazards. Varian expressly disclaims responsibility for loss or damage caused by use of its Products other than in accordance with proper operating procedures.

No warranty is provided by Varian for products sold hereunder which are not manufactured by Varian, but the manufacturer's warranty for such products, if any, shall be assigned to the Customer without recourse to Varian.

THIS WARRANTY IS EXPRESSLY IN LIEU OF AND EXCLUDES ALL OTHER EXPRESS OR IMPLIED WARRANTIES, INCLUDING BUT NOT LIMITED TO WARRANTIES OF MERCHANTABILITY AND OF FITNESS FOR PARTICULAR PURPOSE, USE, OR APPLICATION, AND ALL OTHER OBLIGATIONS OR LIABILITIES ON THE PART OF VARIAN, UNLESS SUCH OTHER WARRANTIES, OBLIGATIONS OR LIABILITIES ARE EXPRESSLY AGREED TO IN WRITING BY VARIAN.

Warranty — Expendable Products

Varian warrants that at the time of delivery expendable items or Products manufactured and sold by it hereunder are free of defects in material and workmanship and conform with Varian's specifications or other specifications expressly agreed to in writing by Varian, BUT VARIAN SHALL HAVE NO OTHER OR FURTHER RESPONSIBILITY THEREFOR, WHATSOEVER, AND VARIAN DISCLAIMS IMPLIED WARRANTIES OF MERCHANTABILITY AND FITNESS WITH RESPECT THERETO.

Damages and Liability

VARIAN'S AGGREGATE LIABILITY IN DAMAGES OR OTHERWISE SHALL NOT EXCEED THE PAYMENT, IF ANY, RECEIVED BY VARIAN FOR THE UNIT OF PRODUCT OR SERVICE FURNISHED OR TO BE FURNISHED, AS THE CASE MAY BE, WHICH IS THE SUBJECT OF CLAIM OR DISPUTE. IN NO EVENT SHALL VARIAN BE LIABLE FOR INCIDENTAL, CONSEQUENTIAL OR SPECIAL LOSS OR DAMAGES OF ANY KIND, HOWSOEVER CAUSED. No action, regardless of form, arising out of, or in any way connected with, the products or services furnished by Varian, may be brought by Customer more than one (1) year after the cause of action has accrued.

USERS OF THIS EQUIPMENT SHOULD BE ALERT TO TWO LEVELS OF HAZARDS IDENTIFIED BY THE FOLLOWING SYMBOLS:

⚠ WARNING

Warnings are used when failure to observe instructions or precautions could result in injury or death.

⚠ CAUTION

Cautions are used when failure to observe instructions could result in significant damage to equipment and/or facilities.

**VARIAN 938-41
PORTA-TEST LEAK DETECTOR**

FACTORY CALIBRATION DATA

Model Number: 938-41 Date: _____
Serial Number: _____ Initials: _____

Your Varian 938-41 Porta-Test Leak Detector has been thoroughly tested out prior to shipment. It is shipped tuned to helium on filament No. 1. Normally, once set, the tuning adjustments are left untouched and calibration may be verified as required.

The data recorded below includes readings taken during the final test prior to shipment. They are convenient for reference purposes if tuning adjustments are altered. Slight changes may occur when using filament No. 2 or after an ion source replacement. Dial, switch, and valve settings prior to shipment are also indicated.

Filament Selection: Filament (FIL.) switch set to No. 1
Ion Voltage: _____ vdc (between TP1 and TP4)
Ion Dial Setting: _____
Focus Voltage: _____ vdc (between TP3 and TP4)
Focus Setting: _____ o'clock
Residual Background: In RUN position.
D.P. Control Setting: _____ o'clock
Range Select Switch: No. _____
Mechanical Pump, Model _____ _____ cfm _____ vac _____ Hz

LIST OF OPTIONS OR ACCESSORIES

_____	_____
_____	_____
_____	_____
_____	_____



varian
IPO SERVICE OPERATION

RETURNED MATERIAL REPORT

THIS REPORT MUST ACCOMPANY all products returned for repair, replacement, or warranty evaluation. Full information regarding reasons for return of the product will expedite repair or adjustment. Please fill in all blanks below and furnish any other information which will help identify the nature and cause of failure.

REASON FOR RETURN (check appropriate box)

- | | | | |
|--|---|--|---------------------------------|
| <input type="checkbox"/> PAID REPAIR | <input type="checkbox"/> ADVANCE EXCHANGE | <input type="checkbox"/> SHIPPING ERROR | <input type="checkbox"/> CREDIT |
| <input type="checkbox"/> WARRANTY EVALUATION | <input type="checkbox"/> LOANER RETURN | <input type="checkbox"/> SHIPPING DAMAGE | |

PRODUCT INFORMATION (use separate forms if more than one model no.)

Varian Model No. _____ Serial No. _____ Quantity _____

PART DESCRIPTION _____

PURCHASE INFORMATION (if product is being returned to warranty evaluation, show your original purchase order number and date purchased)

Varian Sales Order No. (if available) _____ MACHINE # _____

Original Purchase Order No. _____ Purchase Order Date _____

COMPANY NAME _____ CONTACT _____

ADDRESS _____

CITY/STATE/ZIP _____ TELEPHONE _____

FAILURE REPORT (describe in detail suspected cause or nature or malfunction)

RETURNED PRODUCTS

All products returned to Varian/IPO Service Operation for Warranty Evaluation must be sent PREPAID and Customer must comply with the WARRANTY REPLACEMENT AND ADJUSTMENT provision set forth in the warranty.

Ship directly to:

VARIAN ASSOCIATES
 IPO Service Center
 645 Clyde Avenue
 Mt. View, CA 04043

ALL PRODUCTS SOLD BY VARIAN AND RETURNED BY CUSTOMER ARE SUBJECT TO VARIAN ASSOCIATES STANDARD TERMS AND CONDITIONS OF SALE, INCLUDING, BUT NOT LIMITED TO, THE WARRANTY AND DAMAGES AND LIABILITY PROVISIONS SET FORTH IN THE WARRANTY.

TABLE OF CONTENTS

Section		Page
I.	DESCRIPTION	1-1
1.1	Scope of Manual	1-1
1.2	Model Types	1-1
1.3	Test-Cycle Description	1-2
1.4	Physical Description	1-4
	1.4.1 Basic Leak Detector	1-4
	1.4.2 Mechanical Pump	1-6
	1.4.3 Cart-Mounted Leak Detector	1-8
1.5	Specifications	1-9
1.6	Accessories	1-11
II.	INSTALLATION	2-1
2.1	General	2-1
2.2	Unpacking	2-1
	2.2.1 Basic Unit	2-1
	2.2.2 Bench Model	2-1
	2.2.3 Cart-Mounted Version	2-2
2.3	Inspection	2-2
2.4	Leak Detector Location	2-2
2.5	Electrical Connections	2-5
	2.5.1 Primary AC Power Connections	2-5
	2.5.2 Remote Speaker Connection	2-5
	2.5.3 Remote Meter Connections	2-6
2.6	Test Port Connections	2-6
	2.6.1 Evacuated Test Object	2-6
	2.6.2 Helium-Filled Test Object	2-6
	2.6.3 Typical High Vacuum Systems	2-8
	2.6.4 Typical Intermediate Vacuum Systems	2-8
	2.6.5 Test Port Adapters	2-10
	2.6.6 System-To-Detector Coupling Kit	2-10
	2.6.7 Fixtures For Testing Hermetically Sealed Parts	2-10
2.7	Installation Service	2-12
2.8	Storage of Leak Detector	2-12
III.	OPERATION	3-1
3.1	Introduction	3-1
3.2	Controls and Indicators	3-2
3.3	Start-up Procedure	3-6
3.4	Tuning Adjustments and Calibration Check	3-7
	3.4.1 Range Selection	3-9
	3.4.2 Using Calibration Leak for Tuning	3-12
	3.4.3 Using Calibration Leak for Calibration	3-13
	3.4.4 Using Tuning Leak for Tuning	3-14

Table of Contents (cont.)

Section		Page
3.5	Operating Procedures	3-16
	3.5.1 Normal Test Cycle (100 milliTorr or less)	3-16
	3.5.2 Prolonged Pumpdown Cycle (Large Volume)	3-17
	3.5.3 Testing at Higher Pressures (up to 350 milliTorr)	3-17
	3.5.4 Testing at Higher Pressures (above 350 milliTorr)	3-17
3.6	Shutdown and Restarting Procedures	3-18
	3.6.1 General	3-18
	3.6.2 Shutdown for Overnight or Weekend (Standby)	3-18
	3.6.3 Starting After Overnight or Weekend Shutdown (Standby)	3-18
	3.6.4 Complete Shutdown	3-18
	3.6.5 Starting After Complete Shutdown	3-19
	3.6.6 Shutdown For Transporting	3-20
	3.6.7 Starting After Transporting	3-20
	3.6.8 Power Interruption	3-20
3.7	Operating Precautions	3-21
IV.	MAINTENANCE	4-1
4.1	Introduction	4-1
4.2	Daily Maintenance	4-2
	4.2.1 Leak Detector Sensitivity Check	4-2
4.3	Weekly Maintenance	4-2
	4.3.1 Oil Level (Auxiliary Mechanical Vacuum Pump)	4-2
4.4	Semi-Annual Maintenance	4-2
	4.4.1 Mechanical Pump Oil Change — Quick Way	4-2
	4.4.2 Mechanical Pump Oil Change — Complete Shutdown	4-3
4.5	Annual Maintenance (Complete Overhaul)	4-4
	4.5.1 General	4-4
	4.5.2 Preparation	4-5
	4.5.3 Removing the Vacuum System	4-7
	4.5.4 Diffusion Pump Cleaning	4-9
	4.5.5 Spectrometer Tube Cleaning	4-10
	4.5.6 Valve Block Cleaning	4-10
	4.5.7 Installing the Vacuum System	4-12
	4.5.8 Startup Procedure	4-14
4.6	As-Required Maintenance	4-14
	4.6.1 Diffusion Pump Heater or Thermostat Replacement	4-14
	4.6.2 Removing, Cleaning, and Reinstalling Spectrometer Tube	4-15
	4.6.3 Ion Source Replacement	4-20
	4.6.4 Cold Cathode Gauge Cleaning	4-21
4.7	Electronics System	4-22
	4.7.1 General	4-22
	4.7.2 Emission Control Adjustment	4-22
	4.7.3 Adjustment of Ion Source Voltages	4-22
	4.7.4 Adjustment of Thermocouple Gauge	4-23
	4.7.5 Overpressure Protection Adjustment	4-23
	4.7.6 Display Amplifier Adjustment (Leak Rate)	4-24
	4.7.7 Diffusion Pump Power Adjustment	4-25
	4.7.8 Residual Background Check	4-26
	4.7.9 Circuit Board Replacement	4-27

Table of Contents (cont.)

Section		Page
4.8	Leak Detector Self-Test	4-29
4.8.1	General Suggestions	4-29
4.8.2	Test Port Pressure Greater Than 500 Millitorr	4-29
4.8.3	Test Port Pressure Less Than 300 Millitorr	4-29
V.	TROUBLESHOOTING	5-1
VI.	THEORY OF OPERATION	6-1
6.1	General	6-1
6.2	Diffusion Pump	6-1
6.3	Spectrometer Tube	6-4
6.3.1	Principle of Operation	6-4
6.3.2	Explanation of Tuning Controls	6-7
VII.	FUNDAMENTALS OF LEAK DETECTION	7-1
7.1	Leak Testing — Why Is It Needed?	7-1
7.2	Terminology	7-1
7.2.1	Facts About Leak Rates	7-2
7.3	Various Methods of Testing for Leaks	7-2
7.4	Helium Mass Spectrometer Leak Detection	7-3
VIII.	PARTS LIST	8-1
IX.	DIAGRAMS	9-1
X.	APPENDICES	10-1

LIST OF ILLUSTRATIONS

Figure	Title	Page
1-1	Varian 938-41 Porta-Test Leak Detectors	1-0
1-2	Varian 938-41 Leak Detector, Flow Diagram	1-3
1-3	Varian 938-41 Leak Detector, Front View, Access Door Open	1-5
1-4	Rear View of Leak Detector, Top Cover Removed	1-7
1-5	Side View of SD-200 Mechanical Pump	1-7
1-6	Front and Rear Views of Cart-Mounted Leak Detector	1-8
2-1	Cart and Bench Model Installation	2-3
2-2	Roughing Manifold Terminations	2-4
2-3	Evacuated Test Object	2-7
2-4	Helium Filled Object	2-7
2-5	Using the 938-41 to Test Vacuum Systems	2-9
2-6	Typical Intermediate Vacuum Systems	2-9
2-7	Test Port Adapter Kit	2-10
2-8	System-to-Detector Coupling Kit	2-10

LIST OF ILLUSTRATIONS

Figure	Title	Page
2-9	Canister Fixture	2-11
2-10	Large Component Fixture	2-11
3-1	Primary Operating Controls and Indicators	3-3
3-2	Secondary Operating Controls and Indicators	3-5
3-3	Example of How Range Is Selected	3-10
3-4	Example of Range Selection for Leak Rate of 5×10^{-7} cc/sec	3-11
3-5	Valve Operation During Test Cycle	3-15
4-1	Varian 938-41 Leak Detector Removed From Cart	4-5
4-2	Test Port Components Removed	4-6
4-3	Rear View of Leak Detector, Cover Removed	4-7
4-4	Leak Detector With Cover Removed and Main Electronics Assembly Swung Open	4-8
4-5	Valve Block, Diffusion Pump, and Spectrometer Tube Removed From Cabinet	4-8
4-6	Diffusion Pump, Exploded View	4-9
4-7	Valve Block Assembly, Exploded View	4-10
4-8	Valve Lubrication	4-11
4-9	Spectrometer Tube Removal By Releasing KF Clamp	4-13
4-10	Closing Service Valve (CCW Rotation)	4-15
4-11	Valve Operation During Service	4-17
4-12	Spectrometer Tube Removed From Cabinet	4-18
4-13	Spectrometer Tube and Magnet Assembly	4-19
4-14	Spectrometer Tube, Exploded View	4-19
4-15	Ion Source Alignment	4-20
4-16	Opening Service Valve (CW Rotation)	4-21
4-17	Cold Cathode Gauge, Exploded View	4-21
4-18	Preamp Connector	4-25
4-19	Connections for Diffusion Pump Power Adjustment	4-26
6-1	Simplified Block Diagram of 938-41 Leak Detector	6-2
6-2	Cutaway View of Vacuum Diffusion Pump	6-3
6-3	Diffusion Pump With Jet Assembly Removed	6-3
6-4	Cutaway View of Spectrometer Tube	6-5
6-5	Mass Separation	6-7
6-6	Focus Control	6-9
6-7	Ion Control	6-9
6-8	Repeller Control	6-10
6-9	Emission Control	6-10
7-1	Magnetic Separation Principle	7-4
8-1	938-41 Leak Detector, Front View	8-3
8-2	938-41 Leak Detector, Rear View (Cover Removed)	8-3
8-3	Electronics Swung Open	8-4
8-4	High-Voltage Enclosure	8-5
8-5	Diffusion Pump Removed	8-6
8-6	Electrical Power Control	8-7
8-7	Spectrometer Tube Assembly	8-8
8-8	Spectrometer Tube and Magnet Assembly	8-9
8-9	Cold Cathode Gauge	8-10

LIST OF ILLUSTRATIONS (cont.)

Figure	Title	Page
8-10	Diffusion Pump	8-11
8-11	Valve Block Assembly	8-13
8-12	Cart Model, Front View	8-14
8-13	Cart Model, Rear View	8-14
9-1	938-41 Porta-Test Leak Detector, Schematic (Less D.P. Control Board)	9-2
9-2	Diffusion Pump Constant-Power Control Board, Schematic	9-3

LIST OF TABLES

Table	Title	Page
1-1	Varian 938-41 Porta-Test Leak Detector, Detailed Specifications	1-9
1-2	Varian SD-200 and SD-300 Mechanical Vacuum Pumps, Detailed Specifications	1-10
1-3	Cart-Mounted Leak Detector, Detailed Specifications	1-10
1-4	Accessories for 938-41 Leak Detector	1-11
1-5	Items Included in Spare Parts Kit	1-11
3-1	Primary Operating Controls and Indicators	3-2
3-2	Secondary Operating Controls and Indicators	3-4
3-3	Preferred Initial Setting of RANGE SELECT Switch and D.P. CONTROL Dial for Tuning	3-12
4-1	Scheduled Maintenance	4-1
4-2	As-Required Maintenance	4-1
5-1	Corrective Measures	5-3
5-2	Adjustments	5-5

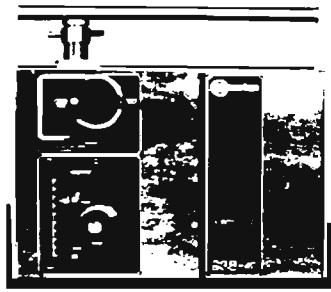

A. Basic Unit

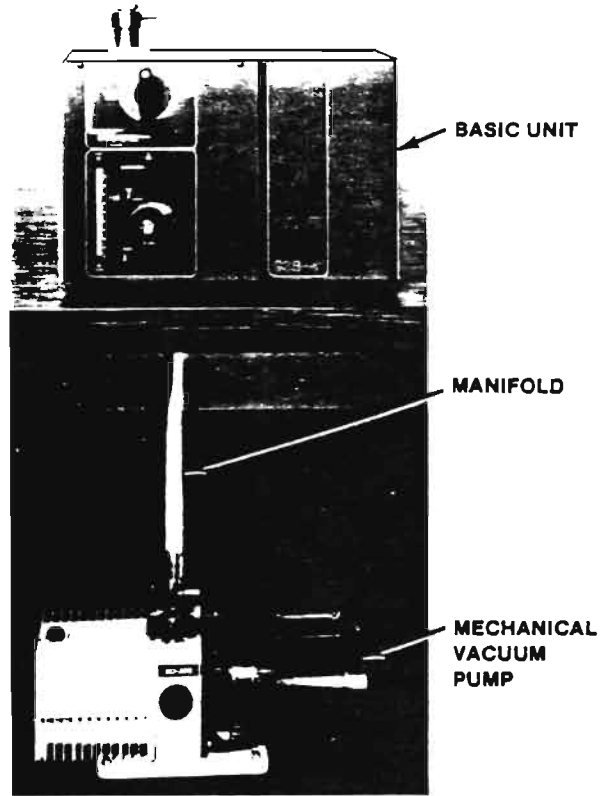

B. Bench Model with SD-200 or SD-300 Mechanical Pump

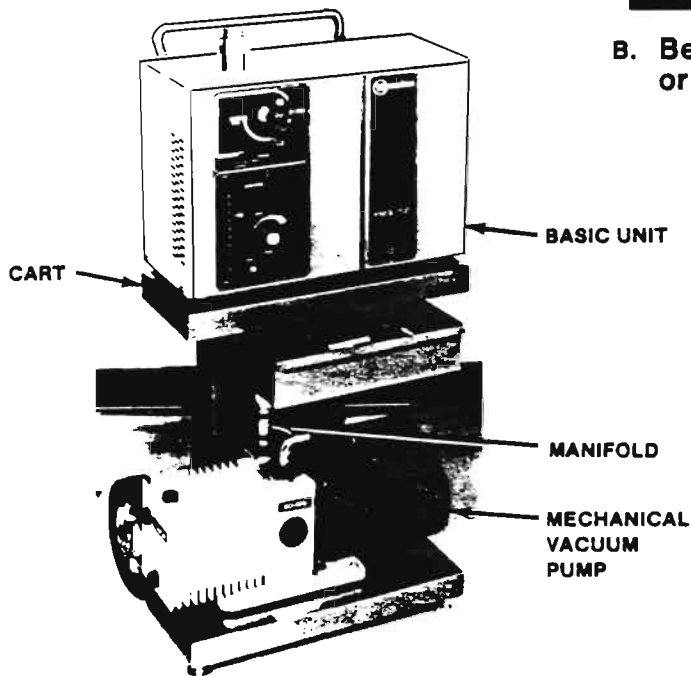

C. Cart-Mounted Version with SD-200 or SD-300 Mechanical Pump

Fig. 1-1. Varian 938-41 Porta-Test Leak Detectors

SECTION I. DESCRIPTION

1.1 SCOPE OF MANUAL

This manual covers the description, installation, operation, theory, and maintenance of the Varian 938-41 Porta-Test Leak Detector at the user level. User maintenance encompasses all of the mechanical assemblies and electronics troubleshooting to the board level. Detailed electronics theory and troubleshooting to the component (integrated circuit) level are provided in a separate service manual (Varian Part No. 6999-09-515).

The Varian 938-41 is a self-contained mass spectrometer leak detector which uses helium as the trace gas. Helium spray probes, system coupling kits, test port adapters and other accessories are available as optional equipment to suit individual requirements.

1.2 MODEL TYPES

There are three types of Varian 938-41 Porta-Test Leak Detectors. They are illustrated in Fig. 1-1 and include: a portable, basic unit which requires a mechanical vacuum pump, such as a Varian SD-200 or SD-300; a bench model, which includes the basic unit with unmounted mechanical vacuum pump and manifold; and a mobile, cart-mounted assembly, complete with basic unit, mechanical vacuum pump, manifold, and interconnecting electrical cabling.

The power requirement for the basic leak detector is 115 vac, 5/60 Hz or 230 vac, 50/60 Hz. The mechanical vacuum pump comes equipped with a single-phase motor. The standard single-phase motor will operate on 115/230 vac, 60 Hz. Mechanical vacuum pumps for 50 Hz operation are also available. Both 7 cfm and 11 cfm mechanical vacuum pumps can be obtained from Varian. The lower-speed model is generally sufficient for leak testing small- to medium-sized objects. Part numbers for the different types of leak detectors are:

Item	Description	Varian Part No.
Basic Unit	Portable enclosure with handle (115 vac or 230 vac, 50/60 Hz)	0938-K9500-301
Bench Model	Basic unit with unmounted mechanical vacuum pump and manifold	
	7 cfm pump (Model SD-200) (115 vac)	0938-K9550-321
	11 cfm pump (Model SD-300) (115 vac)	0938-K9550-322
Cart Model	Basic unit on roll-around cart, complete with mechanical vacuum pump and manifold	
	7 cfm pump (Model SD-200) (115 vac)	0938-K9550-301
	11 cfm pump (Model SD-300) (115 vac)	0938-K9550-302
	Optional drawer in cart	0938-K9597-301

1.3 TEST-CYCLE DESCRIPTION

The Varian 938-41 leak detector is capable of detecting leaks from as large as 1 cc/sec to as small as 2×10^{-10} cc/sec (about 1 cc in 30 years). Major assemblies which comprise the leak detector are illustrated diagrammatically in Fig. 1-2 and include: a mass spectrometer tube; a vacuum diffusion pump; a thermocouple vacuum gauge; a series of valves sequenced by an operating handle; a test port coupling for connecting the object to be tested; and two bar-graph displays, one for use with the thermocouple gauge to indicate test port pressure (in MilliTorr), and one for use with the spectrometer tube to indicate leak rate in the test object.

Initially, both the diffusion pump and the mechanical pump are running and the test port is open (unplugged). With the operating handle in the VENT position, the vent valve is open and the rough valve is closed, so that air and other gases in the inlet manifold are vented to the atmosphere (Fig. 1-2A). At the same time, the test valve is open, so that the diffusion pump evacuates the spectrometer tube and the mechanical pump evacuates the diffusion pump through the foreline. When the diffusion pump is warmed up, the spectrometer tube pressure is low enough ($\leq 2 \times 10^{-4}$ Torr*) to permit the ion-source filament in the spectrometer tube to be energized (there are actually two filaments, but only one is energized at a time).

With the diffusion pump warmed up and the ion-source filament energized, the test object is placed in (or connected to) the test port and secured, establishing a vacuum-tight seal. The operating handle is then turned to the START position, whereupon the vent valve and the test valve are closed, and the rough valve is opened. Under these conditions, the mechanical pump is diverted from its primary function (as forepump to the diffusion pump) long enough to "rough" pump the test object (Fig. 1-2B). This "rough" pumping action may take from several seconds to several minutes, depending on test object volume and mechanical pump capacity.

When the test port pressure is reduced from atmosphere down to a safe level (approximately 100 milliTorr as indicated by the thermocouple gauge and its associated horizontal bar-graph display), the operating handle can be moved to the TEST position (Fig. 1-2C). In this case, the test valve is opened and the mechanical pump is again restored to its primary function as forepump, while continuing to pump the test object. Vacuum communication is now established between the test port and the spectrometer tube.

At this point, helium is applied sparingly to the test object, such as from a spray probe. If there is a leak in the test object, helium entering through the leak will spread to all parts of the evacuated system. Some of this helium will be exhausted through the mechanical pump to atmosphere; the rest of the helium will be diffused through the diffusion pump (against or "contra" the normal flow) and will reach the spectrometer tube. The rate at which helium enters the spectrometer tube is indicated on the associated vertical bar-graph display and can be monitored on an internal or optional external loudspeaker, as desired.

As long as helium from the spray probe enters a leak in the test object, the leak rate will be displayed on the front panel of the leak detector. When the spray probe is removed, the leak rate will drop rapidly as helium is quickly evacuated from the leak detector by action of the diffusion and mechanical pumps.

The end result is a rise and fall of the leak-rate indication on the display, which is directly proportional to the leak rate in the test object.

* 1 Torr = 1000 milliTorr = 1/760 standard atmospheric pressure, hence 10^{-4} Torr is approximately 1/10,000,000 atmosphere. (See Appendix A for other conversions.)

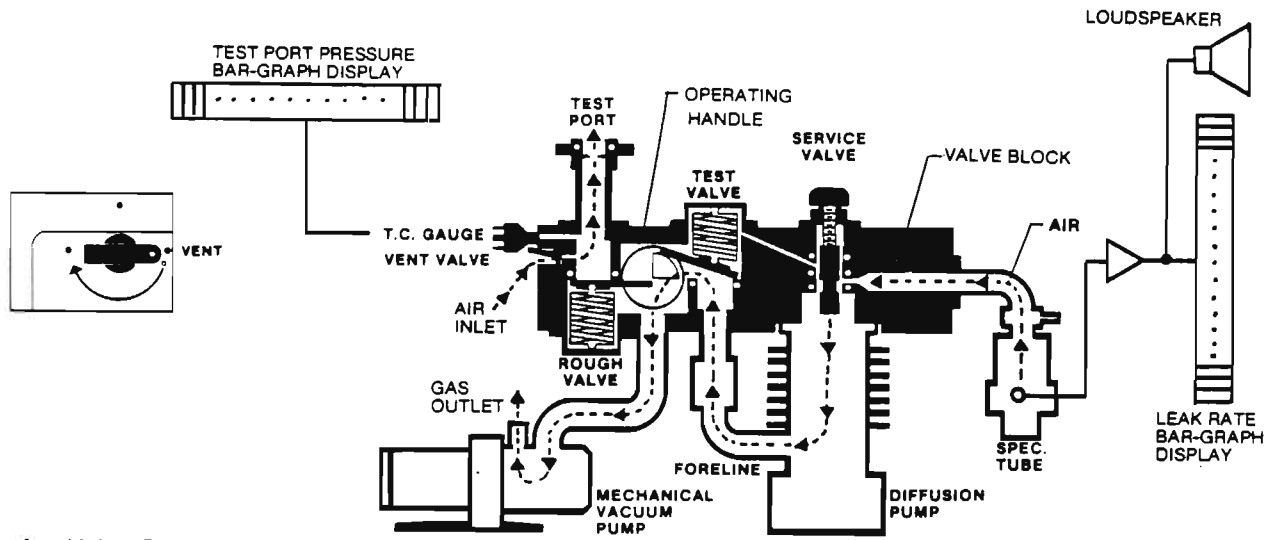

A. Valve Operation - Vent Position

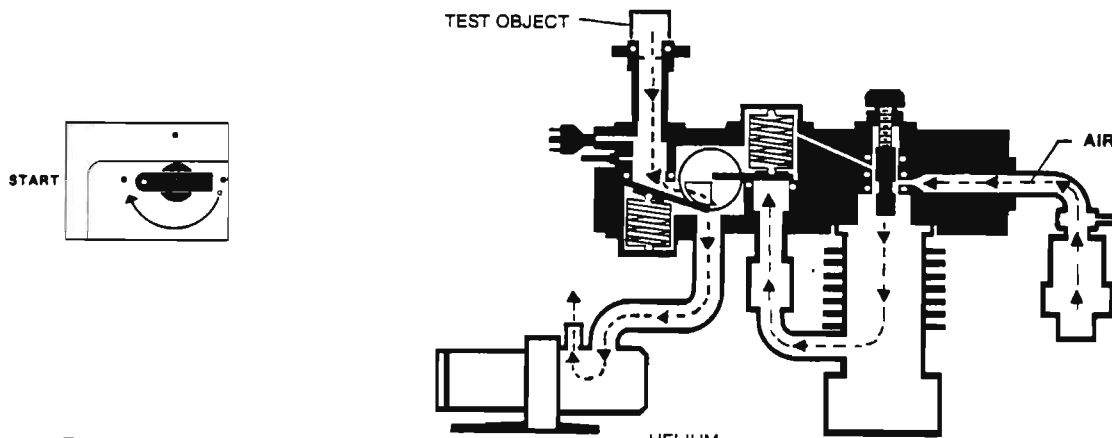

B. Valve Operation - Start Position

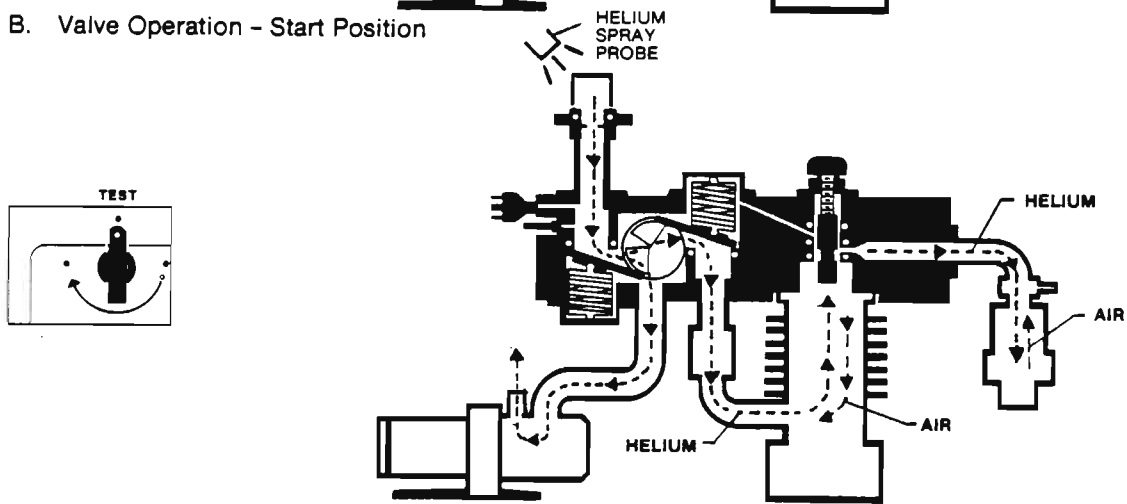

C. Valve Operation - Test Position

Fig. 1-2. Varian 938-41 Leak Detector, Flow Diagram

1.4 PHYSICAL DESCRIPTION

1.4.1 Basic Leak Detector

Figure 1-3 is a front view of the 938-41 Porta-Test Leak Detector with the hinged access door open. The carrying handle and test port coupling are visible at the top of the instrument. (A handle is not furnished with the cart-mounted version.) Condensed operating instructions are provided on a plastic label on the inside of the door.

For convenience, the primary operating controls and indicators are mounted on the front panel of the instrument, to the left of the access door. Secondary controls and indicators, used less frequently, are mounted on panels behind the access door. These secondary controls and indicators are part of the main electronics assembly and the high-voltage enclosure.

The pumpdown and test cycle is controlled by the operating handle, which is a rotatable cam-operated valve. This rotatable valve is used in conjunction with, and linked to, the vent valve, the rough valve, and the test valve to control the normal test cycle. A separate service valve on the back panel is used for isolating the spectrometer tube for routine maintenance procedures. The latter four valves are contained within a single valve block assembly with an opening for the thermocouple gauge.

The rotatable operating handle has separate detents for each of the operating positions (VENT, START, and TEST). A solid white dot at the end of the handle indicates its position. During a test cycle, the handle is always rotated clockwise in the direction of the arrow, from one detent position to the next. There is only one special case (prolonged pump cycle) where the handle is rotated counterclockwise, from the START position to a small open-circle detent beneath the VENT marking.

Test port pressure and roughing pressure are displayed on the log-scale, 20-segment, horizontal bar graph directly beneath the operating handle. This display is calibrated in milliTorr, from zero to atmosphere. A green line above the 100-milliTorr segment informs the operator to wait until this reading is obtained before moving the operating handle from the START position to the TEST position. The bar-graph segments illuminate red.

Directly below the horizontal bar graph is a 50-segment vertical bar graph with an associated digital range exponent which displays helium leak rate from 2×10^{-10} up to 10×10^{-4} cc/sec. These segments are also illuminated red. Associated with the leak rate bar graph are controls for range selection to accommodate different size leaks. Light emitting diodes (LEDs) at the ends of the vertical bar graph indicate over-scale and under-scale conditions.

Other operating controls on the front panel, near the vertical bar graph, are a control for zeroing the leak-rate display, and a green FIL. indicator which lights when the spectrometer tube filament is turned on and emission is present inside the tube. When the FIL. indicator is off, leak testing cannot be accomplished because the spectrometer tube will be unable to detect helium.

In addition to controls for tuning and adjusting the leak rate, the main electronics assembly has controls for calibration, volume adjustment, and filament selection and turn-on. There is a separate switch for checking residual helium (signal background) in the vacuum system after prolonged leak checking. (Very high residual background usually indicates a dirty spectrometer tube and/or vacuum system.)

To the left of the spectrometer tube tuning controls is the high-voltage enclosure. Mounted on this enclosure are the main power on-off switch for the leak detector; a separate on-off switch for the internal electronics, notably for the spectrometer tube; and an analog meter for indicating pressure (in milliTorr) in the spectrometer tube.

The spectrometer tube and its electrical connections are visible in the space below the high-voltage enclosure. A standard KF flange, which connects the spectrometer tube to the valve block assembly above it, enables the spectrometer tube to be vented to the atmosphere for maintenance purposes.

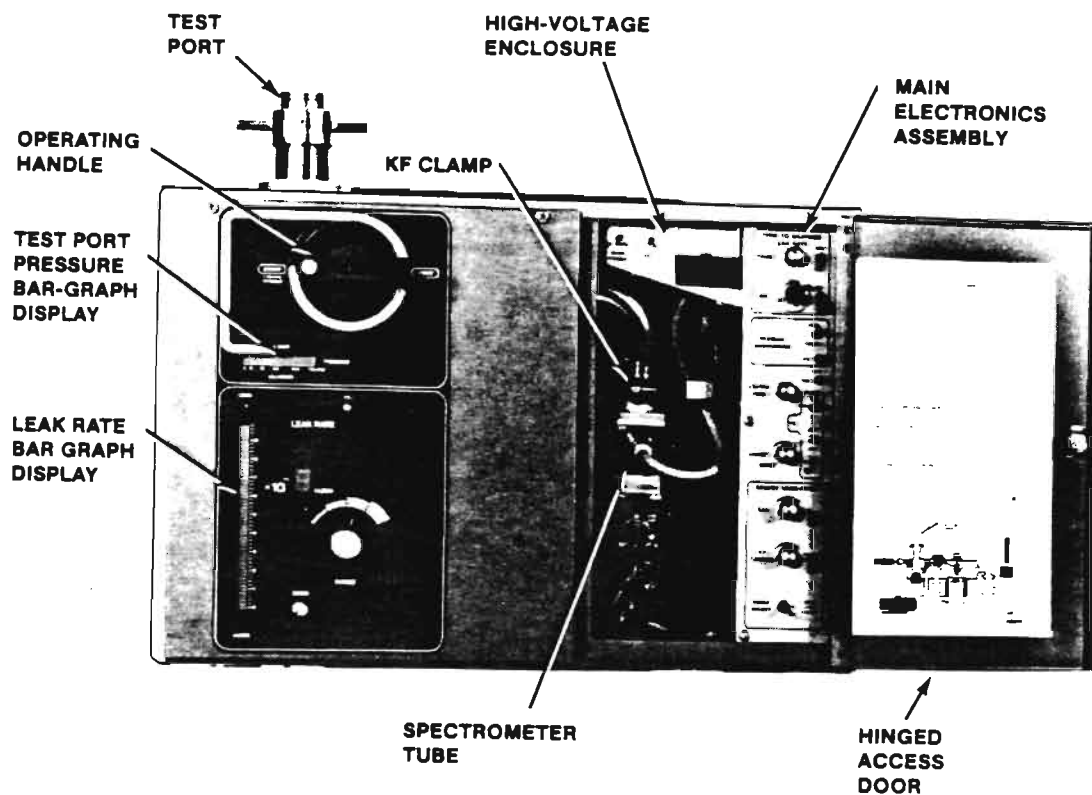

Fig. 1-3. Varian 938-41 Leak Detector, Front View, Access Door Open

A rear view of the 938-41 Leak Detector appears in Fig. 1-4. In this photograph, the top cover of the instrument has been removed to expose the thermocouple gauge and the valve block assembly with its manifold connection to the mechanical pump. The service valve is also identified. This particular valve is closed when its handle is fully out (counterclockwise) and open when its handle is fully in (clockwise).

The thermocouple gauge is connected to the valve block assembly by a simple push-in motion. An O-ring is compressed during the process and not only secures the thermocouple to the block but also effects a good vacuum seal. When primary power is applied, this device senses the test port pressure and provides an electrical signal which drives the horizontal bar-graph display. During test, the test port pressure is at a medium vacuum level provided by the mechanical pump (approximately 10 milliTorr).

The test port coupling above the thermocouple is a 1½ inch diameter quick-connect O-ring sealed compression coupling which enables vacuum-tight connection to the test object, either directly or through an adapter, as required.

Also mounted on the back panel are an exhaust fan for cooling the diffusion pump and the internal electronic assemblies; a pair of push-to-reset circuit breakers (one for the main power and one for the electronics); a grid covering the 4-inch loudspeaker; telephone jack connections for a remote loudspeaker and for a remote meter or recording device (for measuring or recording leak rates); and a heavy-duty power cable.

An internal audio circuit in the 938-41 Leak Detector is connected to the 4-inch loudspeaker and to the remote jack on the back panel of the instrument. It provides an audible signal which can be heard when leak testing is performed at distances near or remote from the 938-41. The frequency, or tone, of the signal varies in direct proportion to the leak-rate measurement: the higher the leak rate, the higher the pitch; the lower the leak rate, the lower the pitch. Loudness is determined by a volume control on the main electronics assembly.

Inside the leak detector cabinet are the spectrometer tube, the diffusion pump, three electronic printed-circuit boards, power and control transformers, interconnecting cabling, and other mechanical and electrical components. The three printed-circuit boards are: the display board, which contains the bar-graph displays and associated drivers; the constant-power control board for the diffusion pump; and the high-voltage power supply board for the spectrometer tube. All three printed-circuit boards, and the main electronics assembly, are replaceable at the user level.

1.4.2 Mechanical Pump

A photograph of the Varian SD-200 Mechanical Pump is shown in Fig. 1-5. The Varian SD-300 is similar in appearance. The pump performs two basic functions:

1. Provides the intermediate vacuum required to operate the diffusion pump (about ten milliTorr). Discharges into the atmosphere.
2. Provides the "rough" pumping capacity required to evacuate the test object to prepare it for testing.

The pump inlet port is equipped with an ISO NW 25 flanged pipe. Connection of the appropriate nipple or fitting is secured by a quick-connect clamp furnished with the pump. Since the pump is airtight, no precaution need be taken on "cold starts", provided the temperature is above 10°C (40°F).

The exhaust port of the pump is equipped with an ISO NW 25 flanged pipe. To pump out the oil mist delivered when the pump is working at high pressure, a hose nipple can be connected to this flanged pipe. A hose can be connected to the outlet if exhaust vapors are undesirable.

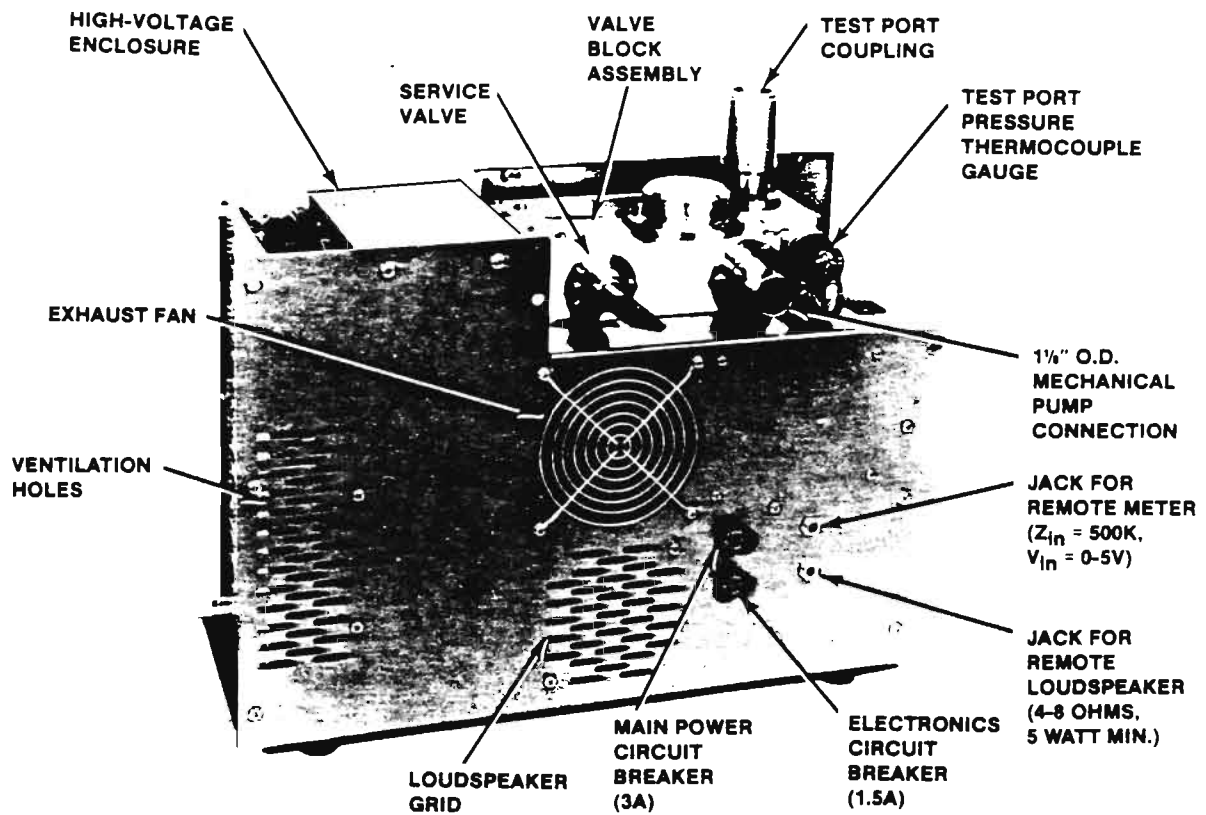

Fig. 1-4. Rear View of Leak Detector, Top Cover Removed

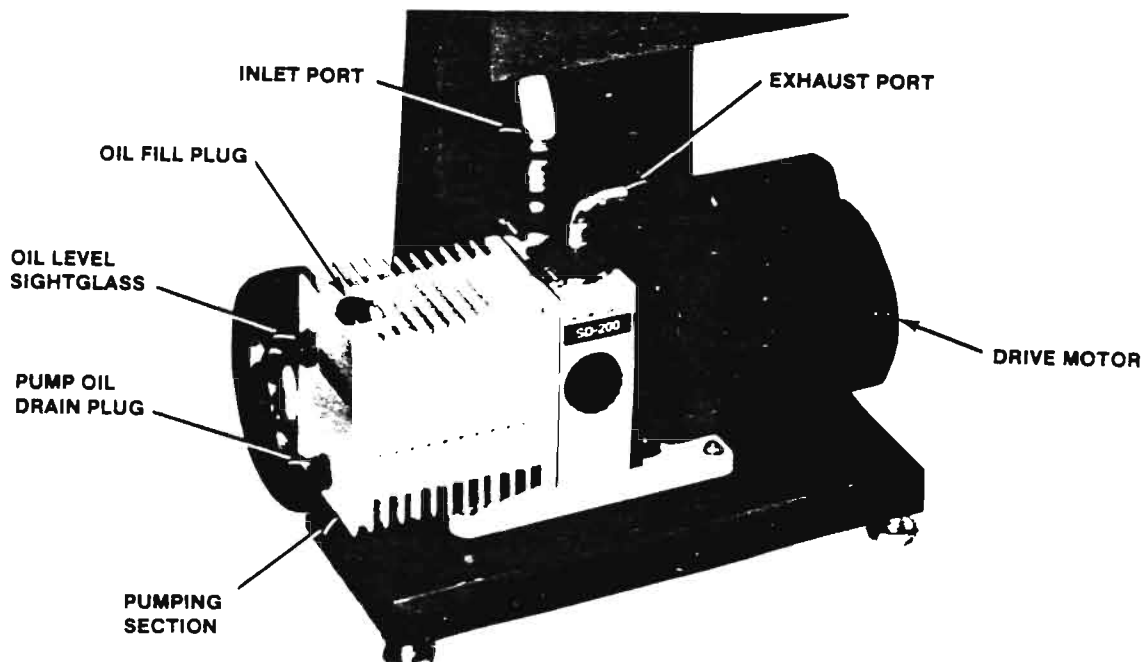

Fig. 1-5. Side View of SD-200 Mechanical Pump

1.4.3 Cart-Mounted Leak Detector

Front and rear views of a mobile, cart-mounted 938-41 Porta-Test Leak Detector with a 7-cfm SD-200 Mechanical Pump are shown in Fig. 1-6. This is a completely self-contained unit, ready for operation. Electrical cables from the leak detector and the pump are plugged into a common power outlet on the back side of the cart. A single circuit breaker on the outlet box controls primary power to both the leak detector and the mechanical pump. When this circuit breaker is closed, the mechanical pump is turned on. However, the leak detector is not turned on until the main power switch on the high-voltage enclosure is placed in the ON position.

The support frame is a sturdy, welded, metal unit with 8" diameter by 1¾" wide semi-pneumatic rubber wheels that do not require air. An optional drawer is convenient for storing probes, tools, calibrated leaks, and other accessories.

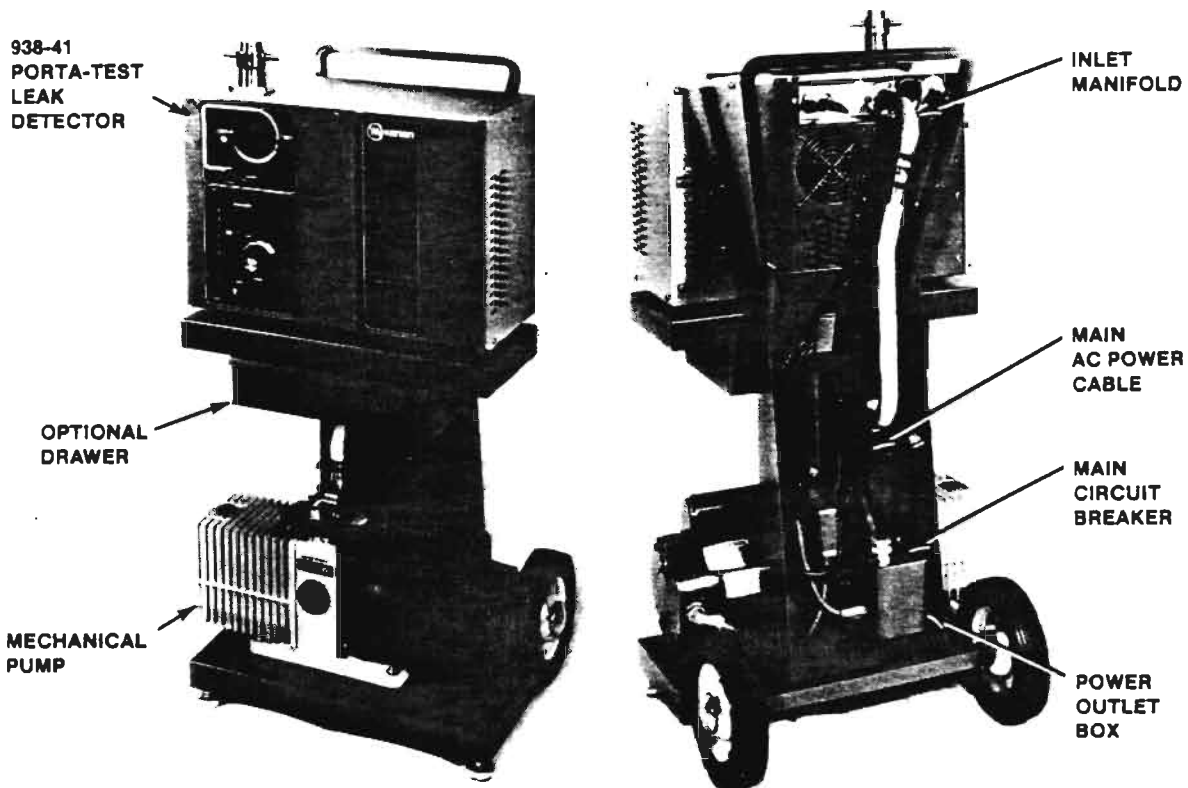

Fig. 1-6. Front and Rear Views of Cart-Mounted Leak Detector

1.5 SPECIFICATIONS

Detailed specifications for the Varian 938-41 Porta-Test Leak Detector are provided in Table 1-1. Specifications for the Varian SD-200 and SD-300 Mechanical Pumps are provided in Table 1-2. Specifications for the cart-mounted unit are provided in Table 1-3.

Table 1-1. Varian 938-41 Porta-Test Leak Detector, Detailed Specifications

MINIMUM DETECTABLE SIGNAL/SENSITIVITY IN ACCORDANCE WITH AVS STANDARD 2.1:

2×10^{-10} atm cc/sec for helium, or
 8×10^{-11} atm cc/sec for air

Note: 938-41 sensitivity is influenced by the speed of the system's mechanical pump. The above specifications are obtained with a normal 7 cfm pump. Minimum detectable signal is registered as one segment when tuned for direct readout on the lowest leak rate range.

RESPONSE TIME

2 seconds for helium in accordance with AVS Standard 2.1

AMPLIFIER DRIFT

Less than 2% of most sensitive scale in accordance with AVS Standard 2.1

NOISE LEVEL

Less than 2% of full scale, peak-to-peak, in accordance with AVS Standard 2.1

LEAK INDICATOR

50-segment bar graph. Three sets of direct reading sensitivity ranges comprised of four decades in each range:

10^{-9} to 10^{-6}
 10^{-8} to 10^{-5}
 10^{-7} to 10^{-4}

EXTERNAL JACKS

One for external optional loudspeaker (4-8 ohm) and one for external optional meter or recorder (0-5 vdc).

SPECTROMETER TUBE

Programmed heating of the entire spectrometer tube during start-up. Preamplifier is a computer-optimized, temperature-stabilized, solid-state device, and is located in the vacuum enclosure. Demountable pole pieces for quick access to the tube interior. The entire tube can be quickly removed for maintenance by the use of a KF flange. Patented dual-filament, disposable, all-welded ion source. Patented integral cold-cathode gauge keeps the source clean. Removable magnet structure for easy cleaning.

DIFFUSION PUMP

90 l/s stainless steel, air-cooled pump developed for the leak detector application. This pump is designed for stable pressure ratio performance for helium. Uses oxidation resistant polyphenyl fluid and is equipped with an optically dense baffle for maintaining system cleanliness.

MANUAL VALVES

O-ring sealed, spring-loaded (75 lb. force), cam-operated roughing and foreline valves incorporated into a valve block design that ensures their proper sequencing.

VACUUM GAUGES

Cold cathode gauge measures high vacuum in the 1 milli Torr to 10^{-5} range in the spectrometer tube. Thermocouple gauge in port manifold monitors the roughing and test pressure.

TEST PORT

$1\frac{1}{8}$ " ID quick coupling is provided.

POWER REQUIREMENTS

115V (230V) 50/60 Hz single-phase power
5 (2.5) amps without mechanical pump
10 (5) amps with 7 cfm pump
15 (7.5) amps with 11 cfm pump

CABINET

8" x $13\frac{1}{2}$ " x $19\frac{1}{2}$ " cabinet with a hinged door provides easy access to spectrometer tube and electronics.

WEIGHT

50 pounds (approximate)
Shipping weight — 60 pounds (approximate)

Table 1-2. Varian SD-200 and SD-300 Mechanical Vacuum Pumps, Detailed Specifications

	MODEL	
	SD-200	SD-300
Stages	2	2
Pumping speed, cfm (l/min)	7 (195)	11 (310)
Ultimate vacuum (partial pressure measurement), Torr	<10 ⁻⁴	<10 ⁻⁴
Water vapor pumping capacity @ 30°C, grams/hr	150	300
Oil capacity, qt/(l)	1.06 (1.0)	0.85 (0.81)
Motor hp	1/2	3/4
Motor speed, rpm (nom)	1725	1725
Inlet port	ISO-KF flange, NW25; alum tube 1.0" (25.4-mm) OD. (Optional NW32 (1.5" (38.1mm) OD; NW40 (1.75" (44.45-mm) OD)	
Outlet port	ISO-KF flange NW25; alum tube 1.0" (25.4-mm) OD.	
Voltage/frequency	1 phase, 115/230 vac, 50/60 Hz	1 phase, 115/230 vac, 50/60 Hz
Overall dimensions, in./(mm) L x W x H	21.5 (546) by 6.5 (165) by 9.83 (250)	21.2 (539) by 7.5 (190) by 8.0 (203)
Shipping Weight, lbs.	52	60

Table 1-3. Cart-Mounted Leak Detector, Detailed Specifications

Dimensions, Overall	
Cart-mounted unit	21" wide by 40 ³ / ₄ " high by 18" deep
Optional drawer	12 ³ / ₄ " wide by 3" high by 7 ³ / ₄ " deep
Weight (approx.)	
Cart-mounted unit	142 lbs.
Power Requirements	
Cart-mounted unit	Same as for basic unit with mechanical pump.

1.6 ACCESSORIES

Accessories available for use with the Varian 938-41 Porta-Test Leak Detector are listed in Table 1-4 and described in the Appendix. Items included in Spare Parts Kit 0981-K7642-801 are listed separately in Table 1-5.

Table 1-4. Accessories for 938-41 Leak Detector

Description	Varian Part No.
O-ring Kit	0981-K7641-801
Spare Parts Kit	0981-K7642-801
Tuning Leak With Carrying Case	0991-K1608-301
Capillary Leak 10^{-4} cc/sec Range	0981-6595-00-104
Capillary Leak 10^{-5} cc/sec Range	0981-6595-00-105
Test Port Adapter for Capillary Leak	0981-84628-306
Calibrating Leak (Integral Helium Reservoir) 10^{-7} cc/sec Range	0981-F8473-301
Calibrating Leak (Integral Helium Reservoir) 10^{-8} cc/sec Range	0981-F8473-302
Detector to System Coupling Kit (includes one system Coupling Valve Kit)	0991-K7954-301
System Coupling Valve Kit (for multiple system leak detection)	0991-K7953-301
Roughing Manifold With KF Flange	0981-K9535-301
Roughing Manifold With Rotatable Elbow	0981-K9533-301
Powerprobe Sniffer Assembly	0991-K9565-301
Helium Spray Probe Kit	0981-K0167-301
Base Plate, 14" Dia., Stainless Steel	0981-85118-301
Inlet Adapter Kit (12 sizes)	0991-86428-801
Additional 938-41 Operator/Maintenance Manual	0981-6999-09-510
938-41 Service Manual	0981-6999-09-515
Leak Detection Handbook	0981-6999-09-070
Optional Drawer for Cart Model	0981-K9597-301
Traveling Case	0981-6999-09-053
Apiezon "L" Vacuum Grease	5000-6954-00-004

Table 1-5. Items Included in Spare Parts Kit (0981-K7642-801)

Qty.	Description	Varian Part No.
2 Qts.	Mechanical Pump Oil	5027-6954-27-002
65 cc	Diffusion Pump Fluid (Santovac 5)	0981-6954-05-002
2	Ion Source	0981-82850-301
1	O-ring Kit	0981-K7641-801
1	531 TC Gauge	0531-F0472-301
2	Cold Cathode Gauge Liner	0981-82849-008
1	Cold Cathode Gauge Ceramic Shield	0981-6480-45-015
1	Apiezon "L" Grease	5000-6954-00-004

SECTION II. INSTALLATION

2.1 GENERAL

This section contains instructions for unpacking, inspecting, and installing the Varian 938-41 Porta-Test Leak Detector at the customer site. Also included are instructions for setting up the leak detector prior to actual operation. Where applicable, individual instructions are provided below for each model type.

The basic unit is intended for system testing and can either be left at one location or moved about. An optional traveling case (Varian Part No. 0981-6999-09-053) is available for this purpose. The case has a foam-lined interior shaped to the leak detector, a pair of recessed wheels, and a pull handle. It can be used instead of a cart for transporting the leak detector to locations already equipped with a suitable mechanical pump.

The bench model is intended for applications in which the leak detector need not be moved to different locations. Thus, once the instrument is placed on a work bench, wall shelf, or other suitable flat surface and connected by manifold to a mechanical pump, it is expected that both units will remain fixed at that location for an extended period.

The cart-mounted model is completely mobile and is intended for those applications where it can be moved quickly and conveniently around an entire plant or other facility on short notice.

2.2 UNPACKING

2.2.1 Basic Unit

The basic unit is shipped in a heavy duty carton with fitted styrofoam cushions for maximum shock protection. Open the carton from the top and remove the leak detector, together with the end cushions. Separate the cushions and save them with the carton if it is likely that the leak detector will be transported by car or shipped to other sites, or to a Varian Service Center for repair. Other items packed in the carton will include one spare ion source, two spare cold-cathode-gauge liners, and applicable documentation. Accessories will generally be packed in the same carton and should likewise be removed. (A complete list of accessories appears in Table 1-4.)

It should be noted that the basic unit is shipped with a roughing manifold stub that terminates with a straight 1½ inch O.D. tubulation. Two optional roughing manifold terminations are available: one with an NW 25 KF flange assembly (Varian Part No. 0981-K9535-301) and one with a 360° rotating elbow (Varian Part No. 0981-K9533-301). If ordered, the selected stub will be shipped in a polybag inside the same carton as the basic unit.

2.2.2 Bench Model

The bench model includes a basic unit and unmounted mechanical pump, pump fluid, and manifold, packaged in two separate heavy duty cartons with fitted styrofoam cushions. Open these cartons and remove the items, as described above for the basic unit. Spares are the same as those supplied with the basic unit.

2.2.3 Cart-Mounted Version

The cart-mounted 938-41 is shipped in a single rectangular box, completely assembled and ready for operation. When the unit has been removed from the box, the box can be discarded since it is not necessary to use it in the event the leak detector or the pump must be forwarded to a service center for repair. (Both the leak detector and the pump are easily removed from the cart for maintenance purposes.)

2.3 INSPECTION

Factory packing provides maximum protection during shipment. However, the leak detector and related items should be inspected immediately after being removed from the packing carton(s). Any damage should be reported to the carrier without delay.

Be sure that you have received every item ordered. (See the **FACTORY CALIBRATION DATA** sheet at the front of this manual.

2.4 LEAK DETECTOR LOCATION

The cart-mounted leak detector can be placed in a convenient storage area, ready for use, or can be moved directly to a test station and hooked up. For the other two model types, the leak detector should be placed on a bench or other flat surface, close to the intended test site. Maximum bench or table-top height is 36 inches (Fig. 2-1).

Any two-stage mechanical vacuum pump can be used, with appropriate hose and/or metal tubulation, provided the pump is capable of reaching 50 milliTorr or less. Do not use a pump that exhibits helium retention characteristics which cause high background. The helium supply should be welding grade in a standard cylinder with its own pressure regulating valve (and hose).

The best arrangement for joining the leak detector and the mechanical pump is to use a soldered copper, welded stainless-steel, or aluminum vacuum-tight manifold whose ends match and abut the 1½ inch O.D. roughing connection at the back of the leak detector and the inlet connection of the mechanical pump. Then the joints are made by fitting a short length of vacuum hose over each end and clamping. Preferred hose is Tygon because of its relatively low retention of helium. Such an arrangement minimizes the surface area of hose exposed to vacuum. An alternative arrangement to a metal manifold is Tygon heavy-walled hose, provided the length does not exceed approximately two feet. Clamp each end to ensure a vacuum-tight seal. Different roughing manifold terminations are shown in Fig. 2-2.

At this point, open the leak detector access door. Be careful not to disconnect any electrical plugs or wiring in the process. Inspect the interior for any damage or loose parts and proceed accordingly.

It is essential to permit the free flow of air around the leak detector. For this reason, allow enough space in the back of the unit so that the exhaust fan is not blocked. The bar-graph displays on the front panel are sufficiently bright to permit operation in a well- or dimly-lighted area.

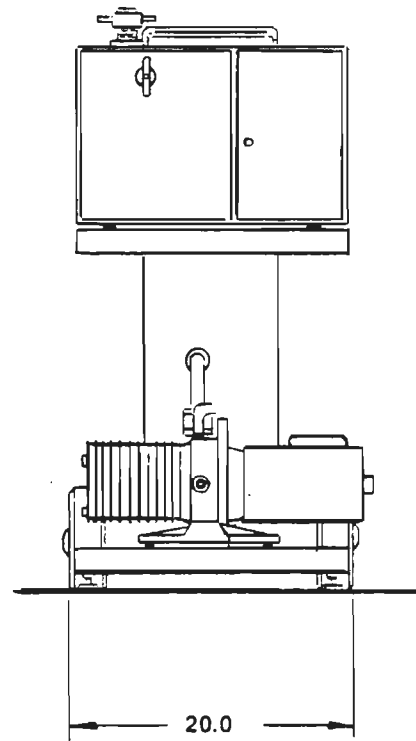
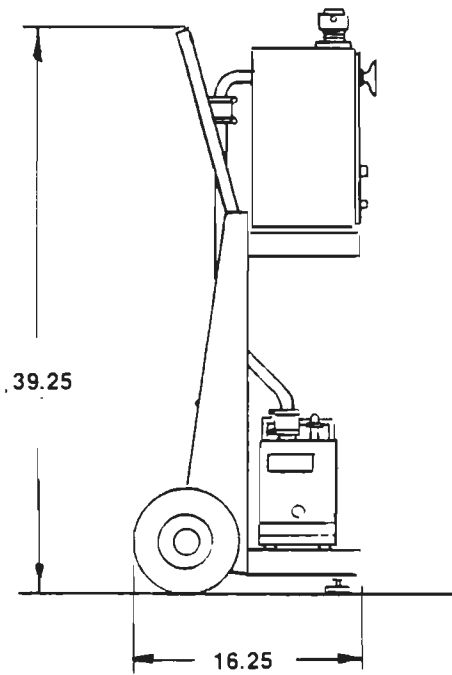

A. Cart Model

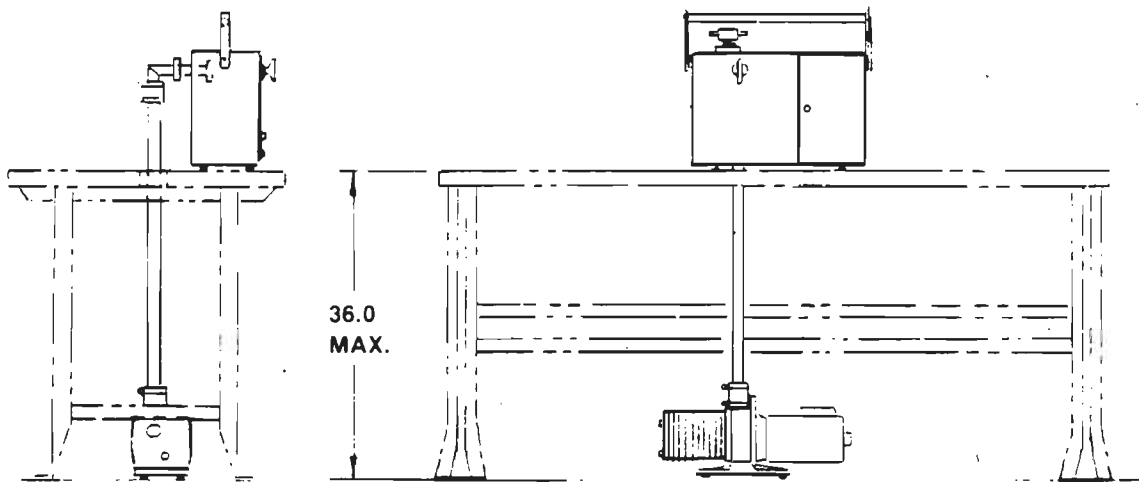

B. Bench Model

Fig. 2-1. Cart and Bench Model Installation

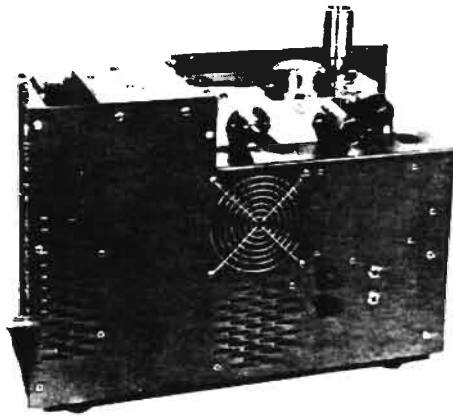

A. Roughing Manifold Stub with Straight 1 1/2 O.D. Tubulation

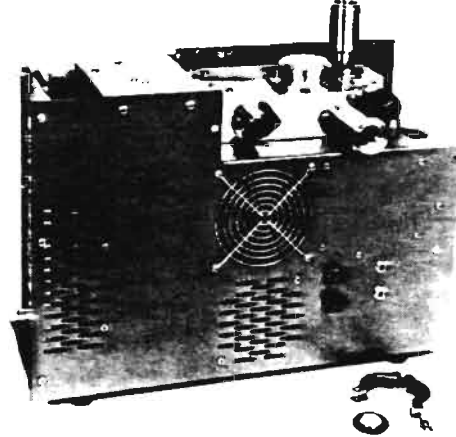

B. Optional Roughing Manifold Stub with NW25 KF Flange

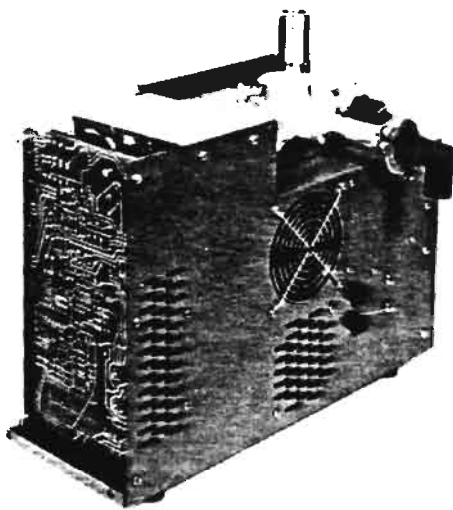

C. Optional Roughing Manifold Stub with 360 Rotating Elbow

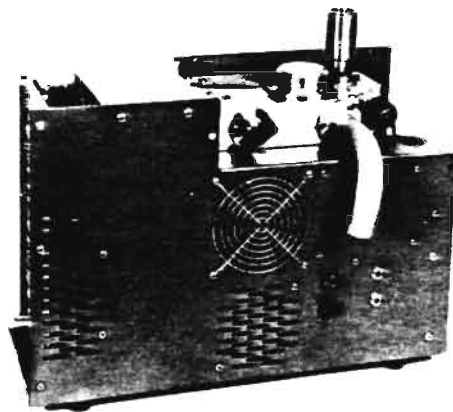

D. Roughing Manifold Stub for Use with Cart Model

Fig. 2-2. Roughing Manifold Termination

2.5 ELECTRICAL CONNECTIONS

Electrical connections include connecting the power cable(s) to an appropriate power line, as well as making connections to a remote loudspeaker or a remote meter or recorder. Before making these connections, there are a few control settings that should be checked on the leak detector.

1. Verify that the MAIN POWER switch on the leak detector is in the off (down) position. In the case of the cart model, verify that the power circuit breaker at the bottom of the cart is also in the off position. The electronics switch (ELECT.) should also be off.
2. Verify that the voltage select switch on the Diffusion Pump Control Board (Fig. 4-18) is in the correct position (115 or 230 vac).

2.5.1 Primary AC Power Connections

The basic unit and the bench model have separate three-prong ac power cables for the leak detector and the mechanical pump. The mechanical pump does not have its own power on-off switch; the leak detector does. In addition, the leak detector has two circuit breakers on its back panel: a 3-amp breaker for the main power and a 1.5-amp breaker for the electronics. The cart-mounted unit, on the other hand, is furnished with a single 3-prong ac power cable and a separate circuit breaker for controlling ac power simultaneously to both the leak detector and the pump. Ratings of the cart circuit breaker are as follows:

With 7 and 11 cfm pumps, 115 vac	single-pole, 12.5 A
With 7 and 11 cfm pumps, 230 vac	double-pole, 6 A

Individual ac power requirements for the leak detector and the mechanical pump are listed below for single-phase power lines:

Basic unit (alone)	115 vac, 50/60 Hz,	5 amps
	230 vac, 50/60 Hz,	2.5 amps
With 7 cfm pump	115 vac, 50/60 Hz,	10 amps
	230 vac, 50/60 Hz,	5 amps
With 11 cfm pump	115 vac, 50/60 Hz,	15 amps
	230 vac, 50/60 Hz,	7.5 amps

Connect the power cables to the appropriate power source.

2.5.2 Remote Speaker Connection

A connector at the back of the leak detector is labelled REMOTE SPEAKER. It enables a loudspeaker (not supplied) to be located up to about 50 feet away. The loudspeaker should have an internal impedance between 4 and 8 ohms, and a 5-watt minimum power capability. The mating plug (not supplied) should be a Switchcraft 237 or equivalent. Both the internal and remote loudspeakers cannot be operated at the same time; when the remote loudspeaker plug is connected to the jack on the back panel, it automatically disengages the internal loudspeaker. The volume control on the main electronics assembly works with either the internal or remote loudspeaker.

2.5.3 Remote Meter Connection

A second connector at the back of the leak detector is labelled REMOTE METER. It enables a remote leak-rate meter or recorder to monitor the results of the leak tests. The remote device should have a minimum input impedance of 500 kilohms and a voltage input range from 0 to 5 vdc. The mating plug (not supplied) should be a Switchcraft 237 or equivalent. This plug is identical to the telephone plug recommended for the remote speaker; pin connection and wire size differ.

2.6 TEST PORT CONNECTIONS*

There are at least four different ways in which an object can be tested with the 938-41 Porta-Test Leak Detector. These approaches are illustrated in Figs. 2-3 and 2-4. In Fig. 2-3, leak location and total leak rate are determined with an evacuated test object. In Fig. 2-4, leak location and total leak rate are determined with a helium filled object. Each approach requires a different test setup and connection to the inlet test port of the leak detector. This problem is circumvented by using special test fixtures and test port adapters.

⚠ WARNING

Do not pressurize any part
of the leak detector
above atmospheric pressure.

2.6.1 Evacuated Test Object

If the object will withstand the one-atmosphere differential pressure caused by internal evacuation, this method is usually easier to carry out and the ability to find small leaks is usually greater. For leak detection, a spray jet is used to direct a fine spray of helium at suspect areas (welds, joints, feedthroughs, etc.). This makes it possible to locate leaks quite accurately and is desirable for products whose value and construction permits repair.

By enclosing the object in 100% helium at normal atmospheric pressure, one can observe the total leak rate and thereby determine whether it is above or below an acceptable level. (If below, the need for leak location testing is eliminated.)

2.6.2 Helium-Filled Test Object

If the object cannot be evacuated and/or it will be sealed, then this method is used. For leak location, a sampling probe (which is essentially a controlled orifice at the end of a length of vacuum hose) is placed near the helium-filled test object. Leaks are located when escaping helium enters the leak detector via the probe. Detection of small leaks requires careful probing techniques, since position and rate of motion are critical.

If the helium-filled object can withstand the one-atmosphere differential pressure caused by external evacuation (in addition to any differential that may already exist from internal pressure), then the vacuum envelope method (typically a bell jar) will permit full sensitivity in determining total leak rate.

* Refer to Section VII for additional information.

**A. LEAK LOCATION
(HELIUM TRACER
PROBE)**

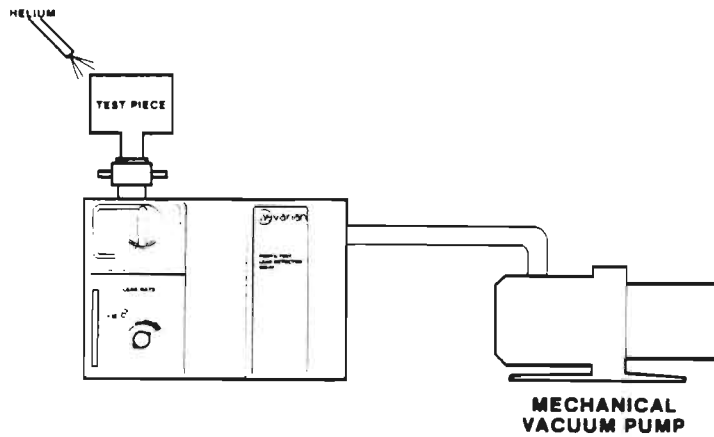

**B. TOTAL LEAK RATE
(HELIUM
ENVELOPE)**

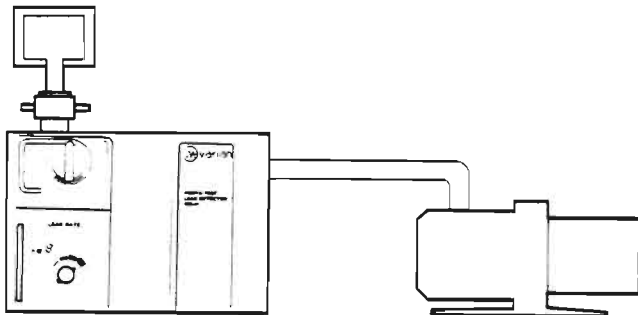
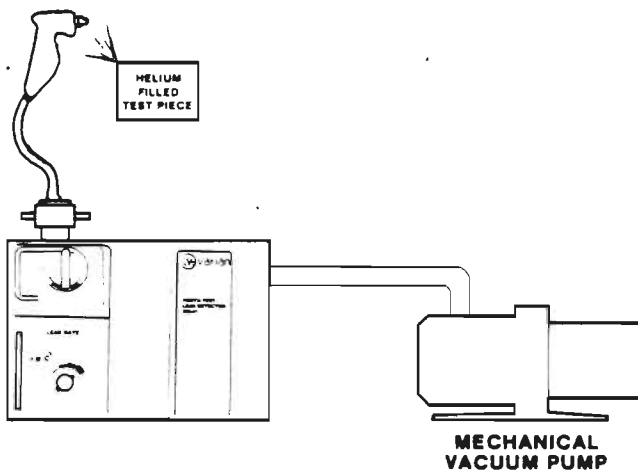

Fig. 2-3. Evacuated Test Object

**A. LEAK LOCATION
(SAMPLING PROBE)**



**B. TOTAL LEAK RATE
(VACUUM
ENVELOPE)**

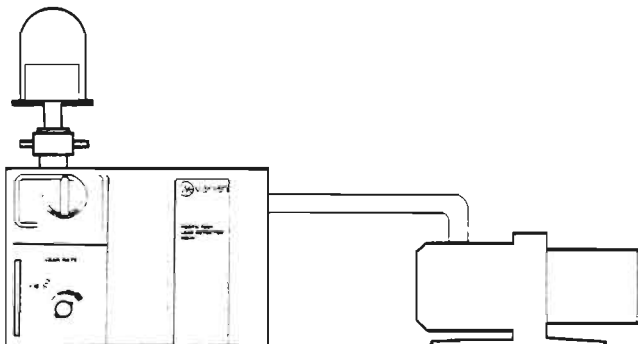

Fig. 2-4. Helium Filled Object

If the presence of helium in the finished object is undesirable, units already sealed may first be placed in a container that is then pressurized with helium for a specific time at a known pressure. Helium will enter the object through any leaks and may be detected later, as in the previous paragraph. Gross leaks may sometimes not be detected, since all helium entering through a large leak may be lost prior to testing. Also, spurious signals may be given by helium not entering the object, but entering surface fissures and remaining long enough to be detected.

Tables are available from Varian showing the relationship between actual leak rates and indicated leak rates for various internal volumes and pressurizing times. This method is commonly used to detect leaks in small electronic packages.

In addition to small- and medium-sized objects, the 938-41 can also be used to test complete vacuum systems, similar to those illustrated in Figs. 2-5 and 2-6. Here again, different fixtures, components, and test adapters may be required for interfacing with the leak detector.

2.6.3 Typical High Vacuum Systems

Many high vacuum systems, such as electron-beam welders, vacuum furnaces, vapor deposition systems, etc., utilize diffusion pumps and mechanical pumps, with appropriate valves for carrying out a process cycle. The 938-41 Porta-Test, complete with associated mechanical pump, is connected to the foreline between the diffusion pump and mechanical pump. Helium is sprayed in a fine jet on suspect areas. If a leak is present, helium enters the system and diffuses rapidly to all parts of the system, including the Porta-Test. When helium is removed from the leak, the residual helium is rapidly pumped out. Response times range from less than one second to several seconds, depending upon volume of the system and pumping capacity of the diffusion pump.

Should more than one system require checking, a quick-disconnect coupling is available that allows the Porta-Test to be transferred from one system to the next without "breaking" vacuum.

The 938-41 Porta-Test may also be connected to the system without its auxiliary mechanical pump (Fig. 2-5). In this case, the mechanical pump in the system also serves as backup for the Porta-Test. However, time must be allowed for the Porta-Test to warm up (as it cannot have been previously operated without a mechanical pump).

2.6.4 Typical Intermediate Vacuum Systems

Reference is now made to systems operating at mechanical pump pressures below 300 milliTorr. A good example is the vacuum insulating jacket of a cryogenic liquid gas storage or transport vessel (Fig. 2-6). Here the 938-41 Porta-Test is connected to the main pumping line, preferably above the isolation valve (if present). Then, when the pressure is low enough, this valve can be closed to permit all of the helium entering a leak to reach the Porta-Test (maximum sensitivity).

Should the operating pressure of the system be higher than 350 milliTorr, a throttling valve may be used. The degree of throttling depends upon the system pressure. The objective is to maintain approximately 100 milliTorr operating pressure in the leak detector.

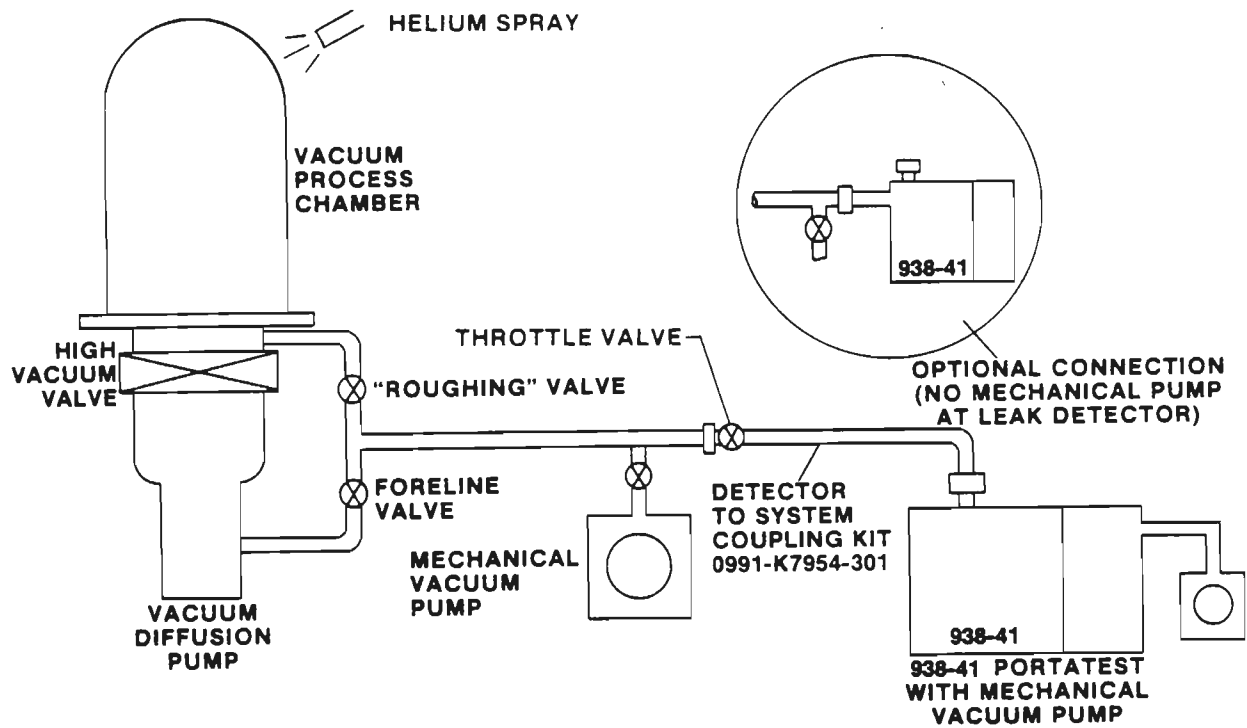

Fig. 2-5. Using the 938-41 to Test Vacuum Systems

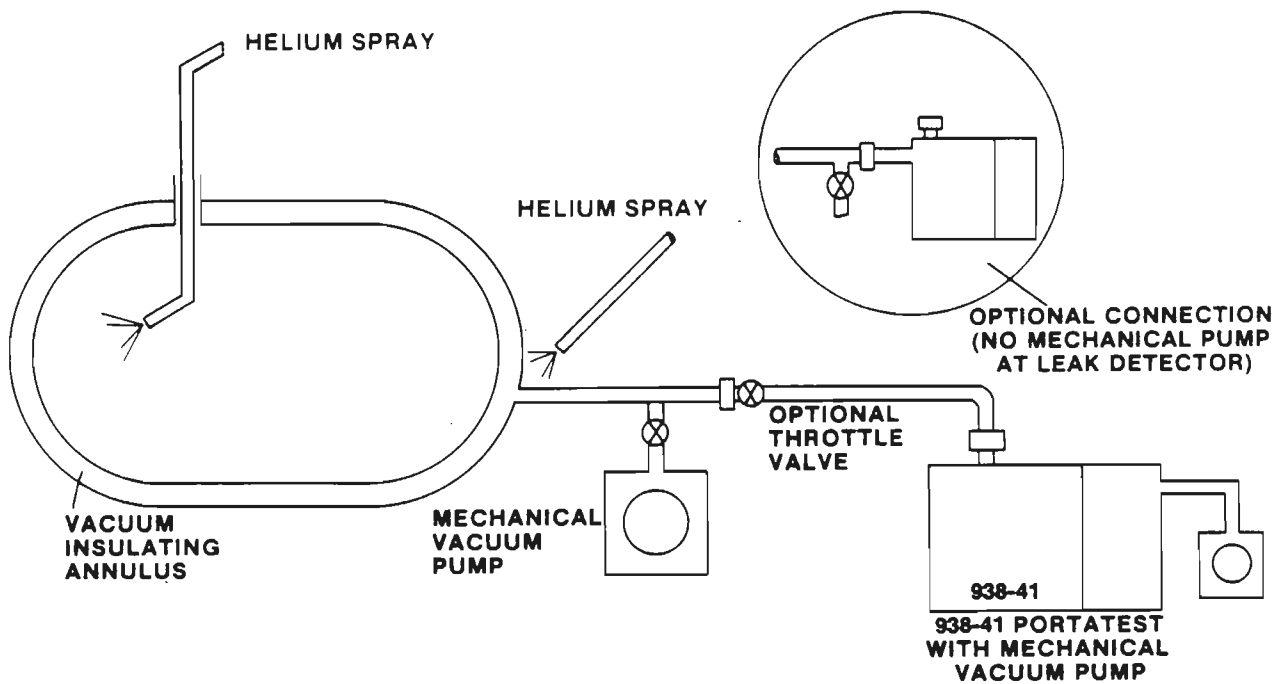

Fig. 2-6. Typical Intermediate Vacuum System

2.6.5 Test Port Adapters

For a general-purpose system, it is convenient to have adapters for a number of tubulation sizes that fit the test port. An Inlet Adapter Kit (Varian Part No. 0991-86428-801) is available for this purpose and accommodates tubulations ranging from $\frac{1}{16}$ inch to 1 inch in diameter. The kit contains 12 different size adapters and is shown in Fig. 2-7.

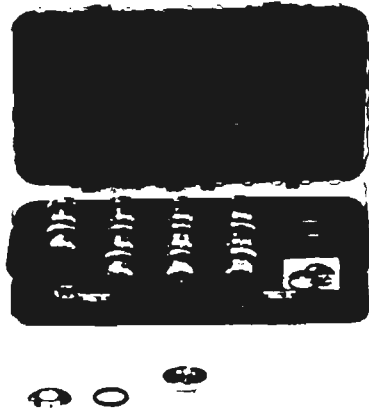

Fig. 2-7. Test Port Adapter Kit

2.6.6 System-To-Detector Coupling Kit (Varian Part No. 0991-K7954-301)

A system-to-detector coupling kit (Fig. 2-8) allows simple connection of the leak detector to a vacuum system. It consists of a valve and adapter that remain on the system. A quick disconnect allows attachment of the leak detector. When vacuum is reached on both sides of the valve, it is opened and the test can commence. It is typically placed on the foreline of the system diffusion pump.

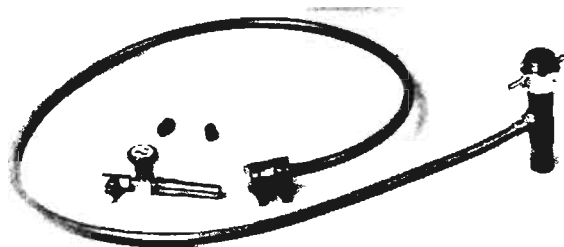
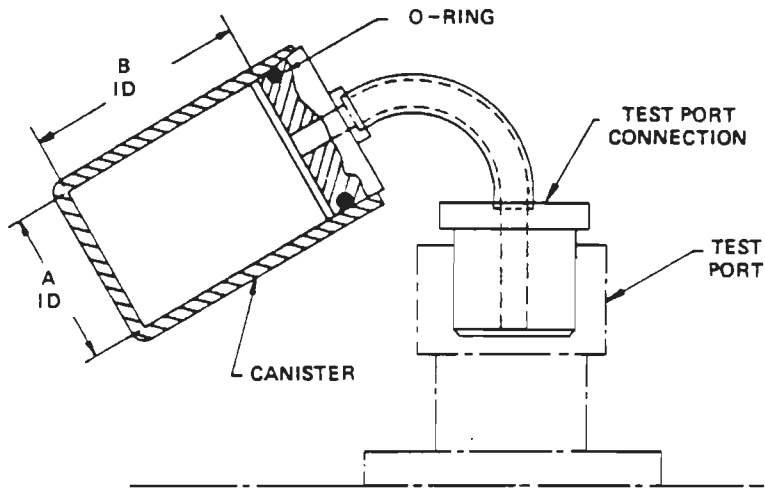

Fig. 2-8. System-to-Detector Coupling Kit

2.6.7 Fixtures for Testing Hermetically-Sealed Parts

Special fixtures are manufactured to test hermetically-sealed parts. Three such fixtures manufactured by Varian are a canister fixture, a cup fixture, and a fixture to test larger components, all used for inside-out testing.

The canister fixture, available in two sizes, is an assembly consisting of two canisters and one test port connector (Fig. 2-9). The use of two canisters promotes faster production in that one can be loaded while the other is in test.



DIMENSIONAL DATA			
	A	B	VARIAN PART NO.
IN	1.50	3.00	0991-K7524-303
CM	3.81	7.62	
IN	2.00	2.00	0991-K7524-304
CM	5.08	5.08	

Fig. 2-9. Canister Fixture

Another fixture, designed for use with larger components, consists of a cylindrical chamber with a cover. Both opening and closing of the fixture cover are performed manually (Fig. 2-10).

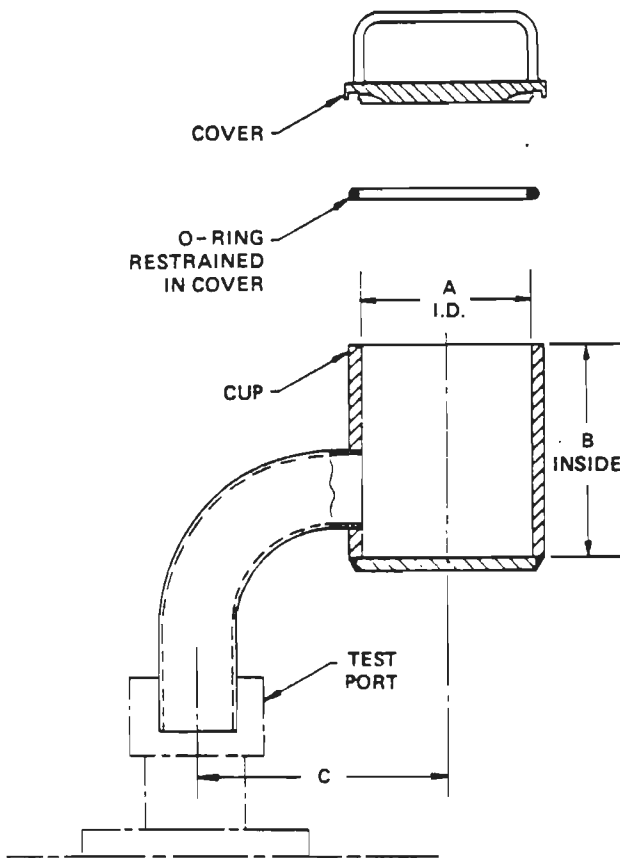

DIMENSIONAL DATA				
	A	B	C	VARIAN PART NO.
IN	3.10	3.10	3.90	0991-K0368-303
CM	7.87	7.87	9.91	
IN	4.05	6.10	4.40	0991-K0368-304
CM	10.29	15.49	11.18	

Fig. 2-10. Large Component Fixture

2.7 INSTALLATION SERVICE

Some of the many different types of fixtures, adapters, tubulation, valves, and other components that could be used in a particular leak detection system are illustrated in Figs. 2-3 through 2-10. In some cases, installation is very simple, requiring a single hose connection to the test port coupling. In other cases, installation is more complex. To ensure that each system is installed properly, start-up assistance by a Varian Marketing Engineer is available on request. Just contact the nearest Varian District Office when your 938-41 is unpacked and ready to be installed and/or operated.

Detailed instruction by a Varian Field Service Engineer in leak detection and operation and maintenance for the 938-41 is available on a per-diem basis.

Courses in leak detection are given several times each year at Woburn, Massachusetts, and Palo Alto, California. These run for three days and include in-depth operational and maintenance instruction for the 938-41. Further information and schedules may be obtained through the Varian IPO Service Center.

Mountain View, Calif.
Toll Free Numbers

Tel. (415) 964-2790
National 800-227-9722
California 800-982-6185

2.8 STORAGE OF LEAK DETECTOR (if not used immediately)

If the leak detector will not be used immediately, it can be stored as received without special precautions. A dry, dust-free area is preferable.

SECTION III. OPERATION

3.1 INTRODUCTION

This section contains instructions for operating the 938-41 Porta-Test Leak Detector by a procedure known as the "test cycle". The purpose of the test cycle is to establish a connection between the test object and the leak detector, so that helium passing through a leak will reach the spectrometer tube and be detected. Instructions are also provided for tuning the spectrometer tube and for calibrating the leak detector prior to operation. It is general practice to tune the spectrometer tube and to calibrate the leak detector at the beginning of each day's testing and at other schedules as may be warranted by the test load.

▲ CAUTION

DAMAGE TO DIFFUSION PUMP

- Do not turn on the main power switch without fluid in the pump. This may ruin the heaters and damage the pump. The 938-41 diffusion pump is charged with the proper amount of fluid when shipped.

DAMAGE TO DIFFUSION PUMP FLUID

- Do not operate the diffusion pump if the mechanical pump is not operating.
- Do not air release the pump while the boiler is hot.
- Do not exceed tolerable foreline pressure in the test port or backstreaming may result. An indication that the pressure has been exceeded occurs when the FIL. indicator goes out.

▲ WARNING

HOT SURFACES

Diffusion pump temperatures can cause burns when touched. Always ensure surfaces have cooled near room temperature before touching them.

3.2 CONTROLS AND INDICATORS

Before operating your 938-41, study the functions of the controls and indicators listed in Tables 3-1 and 3-2. The physical location of the controls and indicators is indicated in Figs. 3-1 and 3-2, respectively.

Table 3-1. Primary Operating Controls and Indicators (Fig. 3-1)

Item	Control/Indicator	Function
1	Operating Handle	Controls the test cycle. Has three basic detent positions: VENT, START, and TEST. Normally turned in clockwise direction. (During prolonged pump cycle, handle can be rotated counter-clockwise, from START position to small open-circle detent beneath the VENT marking in order to restore spectrometer tube pressure without venting the test object.)
2	Test Port PRESSURE Indicator	Bar-graph display to indicate test port pressure in milliTorr.
3	LEAK RATE Display	Vertical bar-graph display. Indicates leak rate in test object in std cc/sec. Over-scale and under-scale conditions are indicated by LEDs at the top and bottom of this display, respectively. Exponent in window next to $X10^{\quad}$ marking will be 4, 5, 6, 7, 8, or 9, depending on settings of RANGE and RANGE SELECT switches.
4	RANGE Switch	Four-position rotary switch to select range scale. Arcs over switch, from left to right, go from small leak (most sensitive) to large leak (least sensitive) range.
5	ZERO Adjustment	Potentiometer used for fine zero adjustment of leak-rate display.
6	FIL. Indicator	Green LED which lights when spectrometer tube filament is turned on and emission is present. This indicates that the leak detector is ready for testing.

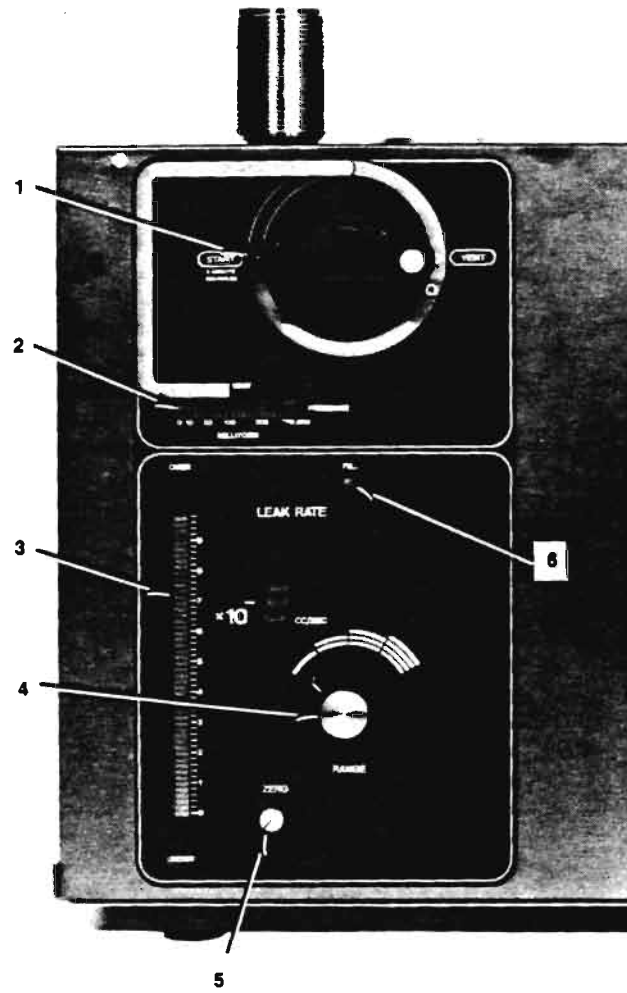

Fig. 3-1. Primary Operating Controls and Indicators

Table 3-2. Secondary Operating Controls and Indicators (Fig. 3-2)*

Item	Control/Indicator	Function
1	MAIN POWER Switch	Main power control for leak detector. Controls power to bar-graph displays, diffusion pump, test port pressure circuits, and spectrometer tube heater.
2	ELECT. Switch	Controls application of high voltage to spectrometer tube and standard voltages to associated electronics. When switch is on, the spectrometer tube heater is off.
3	SPECTROMETER TUBE Meter	Indicates pressure in spectrometer tube, in units of milli Torr. Green band at low end of scale indicates safe region for operation. If pressure rises above 0.2 milli Torr, the filament will shut off.
4	FOCUS Control	Potentiometer for adjusting the focus plate-to-chamber voltage in the spectrometer tube. Normally used for tuning the spectrometer tube.
5	ION Control	A 10-turn potentiometer for adjusting the ion source chamber voltage. Normally used for tuning the spectrometer tube.
6	RESIDUAL BACKGROUND switch	Two-position toggle switch. Used in conjunction with leak-rate display to check amount of residual background in vacuum system. Normally left in RUN position, except when moved to CHECK position to determine amount of background helium.
7	COARSE ZERO Adjustment	Potentiometer used for coarse zero adjustment of leak-rate display.
8	FIL. Selector Switch	Toggle switch selects filament No. 1 or No. 2.
9	FIL. Power ON-OFF Switch	Momentary toggle switch for energizing or deenergizing tube filament.
10	EMIS Control	Screwdriver adjustment for spectrometer tube emission by varying filament current (tuning).
11	AUDIO Control	Volume control for internal or optional external loudspeaker (audible alarm).
12	CAL. Control	Calibration potentiometer. Adjusts amplifier gain to make leak-rate reading agree with calibration leak.
13	D.P. CONTROL	Controls heater power to diffusion pump and thus sensitivity of leak detector. Permits variation of maximum pressure ratio of helium. Used to make leak-rate readings agree with the calibration leak.
14	RANGE SELECT Switch	Three-position toggle switch for selecting minimum leak rate. Used in conjunction with RANGE switch. In position 7, single arc over RANGE switch represents 10^{-7} range; two arcs represent 10^{-6} range; three arcs represent 10^{-5} range; and four arcs represent 10^{-4} range. Similar function for positions 8 and 9 to represent ranges of: <div style="display: flex; justify-content: space-between; margin-left: 100px;"> <div>Position 8</div> <div>10^{-8} to 10^{-5} cc/sec</div> </div> <div style="display: flex; justify-content: space-between; margin-left: 100px;"> <div>Position 9</div> <div>10^{-9} to 10^{-6} cc/sec</div> </div>

* Used mainly for tuning and calibrating purposes.

- 15 Rotatable Magnetic Pole Pieces (Large Black Knobs) Permit adjustment of ion source electron beam direction for maximum ionization and sensitivity. Used only for tuning a new ion source.
- 16 Service Valve Isolates spectrometer tube for service and shipping. Also used when evacuating the spectrometer tube after service.

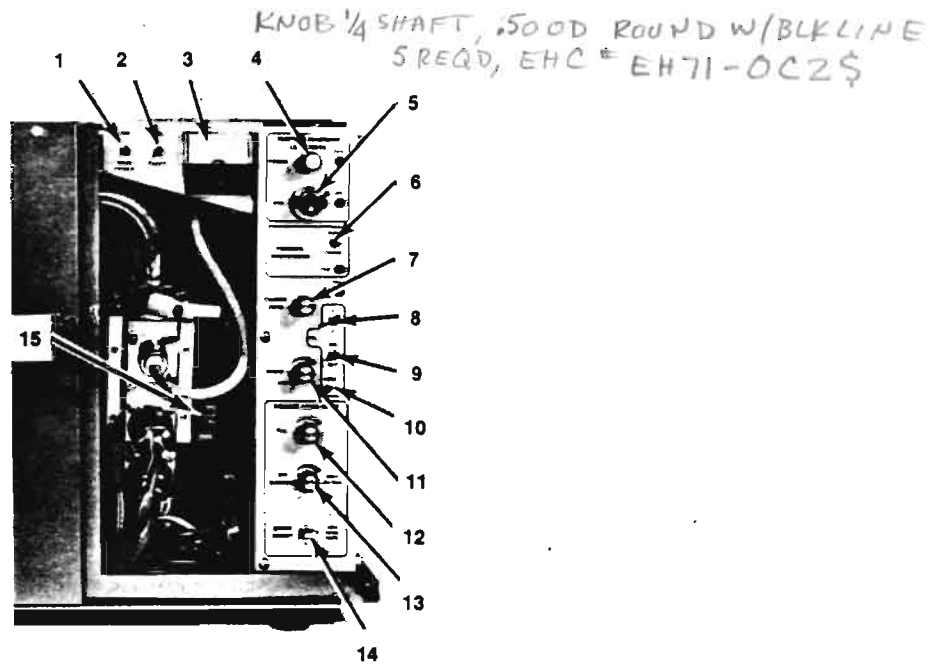

Clockwise to Open;
Counterclockwise to Close

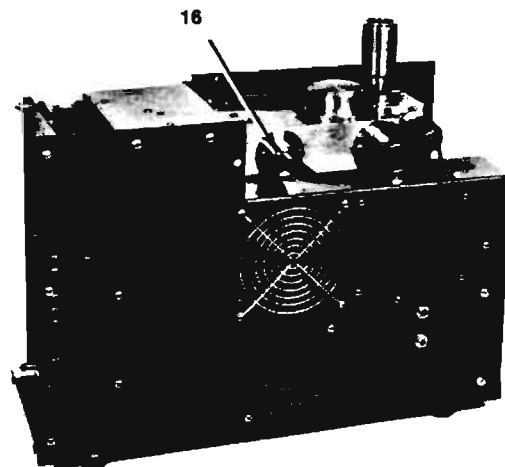

Fig. 3-2. Secondary Operating Controls and Indicators

The location of the primary power circuit breaker on the cart-mounted 938-41 Porta-Test Leak Detector is shown in Fig. 1-6. This circuit breaker controls main ac power to both the leak detector and the mechanical pump. It is used as a supplement to the MAIN POWER switch under the access door on the front panel of the leak detector.

The leak detector is tuned and calibrated at the factory prior to shipment. All of the controls have been preset so that the initial step for the user is to follow the start-up procedure.

3.3 START-UP PROCEDURE

This procedure should be followed when first starting up the leak detector (after installation or transporting).

1. Check the mechanical pump connection to the leak detector. Be sure there is a vacuum-tight seal at both ends.
2. Place a plug in the test port or "valve off" the input so that no air or other gas can enter the inlet manifold.
3. Verify that the operating handle is in the START position, the MAIN POWER switch and the ELECT. switch are both in the off position (down), the D.P. CONTROL knob is full counterclockwise (high power setting), the No. 1 filament is selected, and the service valve at the back of the cabinet is closed (full counterclockwise). Also verify that the RESIDUAL BACKGROUND switch is in the RUN position. (**This is the "as-shipped" condition.**)
4. Turn on the mechanical pump by closing its associated power switch or circuit breaker. (In the case of the cart-mounted unit, close the circuit breaker at the bottom of the cart.) The mechanical pump will gurgle momentarily.
5. Place the MAIN POWER switch on the leak detector in the ON position.
6. With main power applied to the leak detector, all of the segments on the bar-graph displays should light for approximately 3 seconds and then go out, indicating that they are operational. Random readings will appear on the leak-rate bar graph and can be ignored. At this time, the diffusion pump will start to warm up.
7. With the operating handle still in the START position, observe the test port pressure. When the pressure drops down from atmosphere to within 5 to 10 milliTorr (in about 5 seconds), move the operating handle to the TEST position.

NOTE

Never leave operating handle in START position longer than 5 minutes.

8. Carefully turn the service valve (at the back of the cabinet) all the way in (clockwise about 7 full turns), then back off $\frac{1}{8}$ turn (about 45°). This allows the valve shaft to "float" inside the O-rings for optimum sealing.

9. Wait 30 minutes for the diffusion pump to heat up and reach operating temperature, and then place the ELECT. switch in the ON position. If the diffusion pump is ready for operation, the pointer on the SPECTROMETER TUBE pressure meter will be less than 0.2 milliTorr (in green band). (If not less than 0.2 milliTorr or not within the green band, place the ELECT. switch in the off position, wait 10 more minutes, then try again. If the pressure indication is still well above the green band, see Section V, Troubleshooting.)
10. Flip the FIL. switch to the ON position and release it. The green FIL. indicator on the front panel should light, indicating that the filament is energized and emitting electrons. (If the SPECTROMETER TUBE meter pointer goes out of the green band and the FIL. indicator goes out, because of filament outgassing, wait 2 to 5 minutes, then try again. It may be necessary to repeat this step several times.)
11. With the SPECTROMETER TUBE meter pointer within the green band and with the FIL. indicator illuminated, the instrument is ready to be tuned and calibrated prior to leak testing.

3.4 TUNING ADJUSTMENTS AND CALIBRATION CHECK

Before beginning the day's testing, and as otherwise scheduled, the spectrometer tube should be properly tuned so that it is sensitive to helium. This is generally done by using a standard reference leak of known value, called a **calibration leak**. Two types of calibration leaks are available: those with a helium reservoir* and those that operate on the capillary principle and require a helium source from the user. An alternative to the calibration leak is the tuning leak, which uses the helium present in the surrounding air. (The helium in ambient air is normally present at a concentration of about 5 parts per million. This is sufficient to provide a large enough signal to tune the spectrometer tube. It should be noted, however, that the tuning leak, unlike the calibration leak, is an uncalibrated source of helium and therefore can only provide relative rather than precise values.)

*The calibration leak contains a reservoir of helium which permeates through an internal glass barrier at a very low and constant rate, regardless of whether the built-in valve is open or closed. The valve should be left open. This prevents helium build-up behind it (with resulting "burst" of high indication on the LEAK RATE displays and subsequently slightly higher-than-normal reading until helium is desorbed from the valve seals). The purpose of the valve is to permit a zero check when using the calibration leak and to verify the helium peak (but not adjacent peaks).

Varian calibration leaks with a helium reservoir are designed with leak rates in the range of 10^{-7} and 10^{-8} std cc/sec. Varian calibration leaks operating on the capillary principle are designed with leak rates in the range of 10^{-4} and 10^{-5} std cc/sec. Varian tuning leaks are generally designed for approximately a 10^{-6} std cc/sec leak-rate signal at 100 milliTorr test port pressure. Typical Varian calibration leaks are shown below; a typical tuning leak is also shown below. (Details on Varian calibration and tuning leaks are provided in the Appendix.)

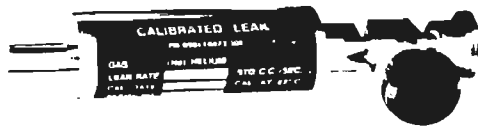

10^{-7} std cc/sec. range -
0981-F8473-301

10^{-8} std cc/sec. range -
0981-F8473-302

A. Calibration Leak with Helium Reservoir



10^{-4} std cc/sec. range -
0981-6595-00-104

10^{-5} std cc/sec. range -
0981-6595-00-105

Inlet adapter for capillary leak:

order number: 0991-86438-306

B. Capillary Type of Calibration Leak

Varian Calibration Leaks

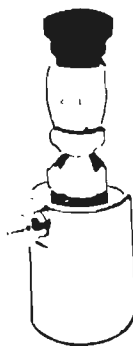

order number
0991-K-1608-301

Varian Tuning Leak

3.4.1 Range Selection

Directly below the horizontal bar graph is a vertical bar graph (with a digital range exponent) which displays helium leak rate from 2×10^{-10} up to 10×10^{-4} cc/sec. These segments are illuminated red. Associated with the leak-rate bar graph are three sets of direct reading sensitivity ranges comprised of four decades in each range:

10^{-9} to 10^{-6}
 10^{-8} to 10^{-5}
 10^{-7} to 10^{-4}

Range selection is determined by the RANGE SELECT switch on the control panel behind the access door. Decade selection is determined by the rotary RANGE switch next to the vertical bar graph. Arcs over the RANGE switch are interpreted as follows:

One arc indicates a small leak rate
Two arcs indicate a leak rate larger by a factor of 10
Three arcs indicate a leak rate larger by a factor of 100
Four arcs indicate a leak rate larger by a factor of 1000

To illustrate: Assume the RANGE SELECT switch is set at the number 9 (Fig. 3-3). When the RANGE switch points to one arc, the full-scale reading on the vertical bar graph is 10×10^{-9} . When the RANGE switch is moved to the two-arc position, the full-scale reading is 10×10^{-8} . (Thus, a reading of 10×10^{-9} in the one-arc position is the same as 1×10^{-8} in the two-arc position.) When the RANGE switch is moved to the three-arc position, the full-scale reading is 10×10^{-7} , and when the RANGE switch is moved to the four-arc position, the full-scale reading is 10×10^{-6} .

In a similar fashion, if the RANGE SELECT switch is set at the number 8, then the full-scale arc readings are 10×10^{-8} , 10×10^{-7} , 10×10^{-6} , and 10×10^{-5} , respectively. When the RANGE SELECT switch is at number 7, then the full-scale arc readings are 10×10^{-7} , 10×10^{-6} , 10×10^{-5} , and 10×10^{-4} , respectively.

Under scale and over scale LEDs (light emitting diodes) are located at the ends of the vertical bar graph. If the bar-graph ZERO control is such that no segments on the vertical bar graph are illuminated, the corresponding UNDER scale LED at the bottom of the bar graph will be illuminated, indicating that the ZERO control should be adjusted so that one segment is lit (with no helium or leak present). If the OVER scale LED at the top of the vertical bar graph is illuminated (along with the 50 bar-graph segments), a larger leak range should be selected.

The effect of selecting the wrong range is illustrated in Fig. 3-4. In this case, the actual leak rate is 5×10^{-7} cc/sec. If the RANGE SELECT switch is at number 8 and the RANGE switch points to three arcs, the leak is too small for this range, and the RANGE switch must be moved to a smaller leak-rate range, as depicted in Fig. 3-4B. Illuminating the bar graph at mid- or near-mid range is generally satisfactory for a series of similar leak tests. Selecting a range for which the leak is too large results in an over-scale condition, as illustrated in Fig. 3-4C.

Initial positioning of the RANGE SELECT switch and the D.P. CONTROL on the main electronics assembly, when tuning the spectrometer tube, depends on the test object leak size specification and the operating range of the device being used for tuning. Table 3-3 indicates the preferred positions of the RANGE SELECT switch and the D.P. CONTROL under these conditions. For example, if the anticipated test object leak rate specification is in the 10^{-4} cc/sec range, then a calibration leak in the 10^{-4} , 10^{-5} , 10^{-6} or 10^{-7} range, or a tuning leak, is acceptable and No. 7 is the preferred position of the RANGE SELECT switch. On the other hand, if the anticipated test object leak rate specification is in the 10^{-9} range, then a calibration leak with a range of 10^{-7} or 10^{-8} would be required, and No. 9 would be the preferred setting of the RANGE SELECT switch.

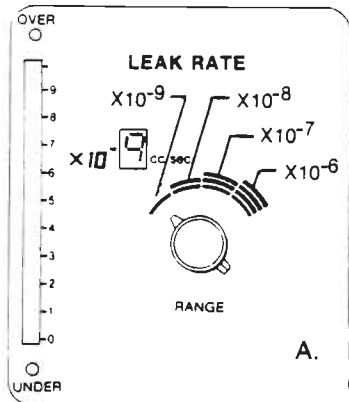

A. Most Sensitive Range
(Very small leaks)

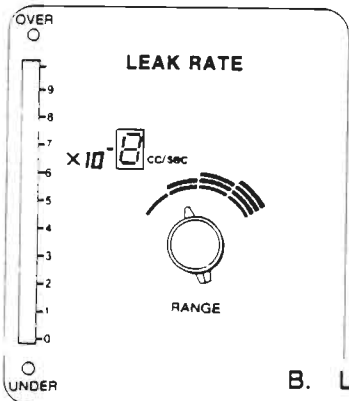

B. Less Sensitive Range

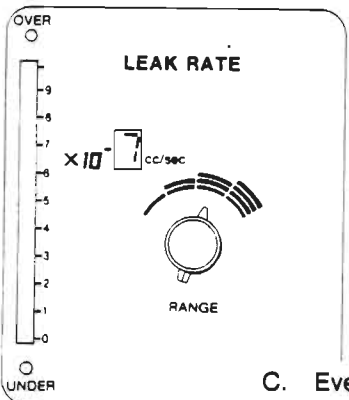

C. Even Less Sensitive Range

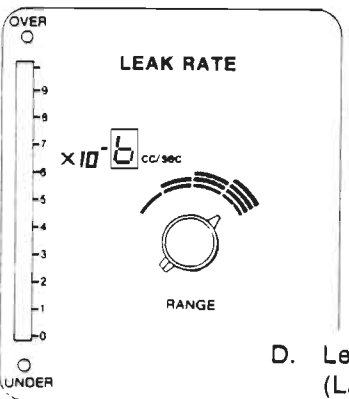

D. Least Sensitive Range
(Large leaks)



Fig. 3-5. Example of How Range is Selected

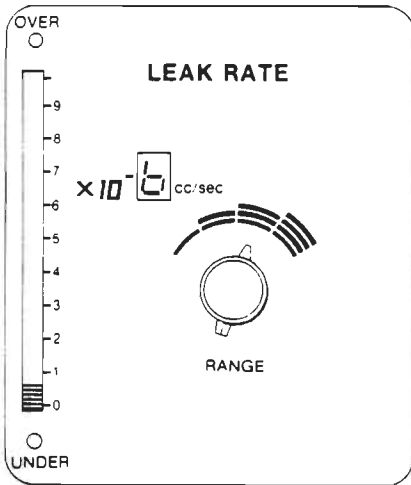

A. Leak too small for this range

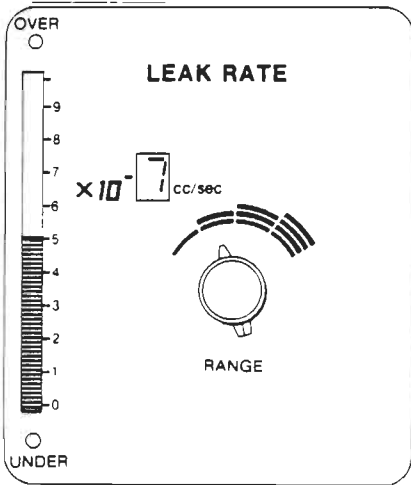
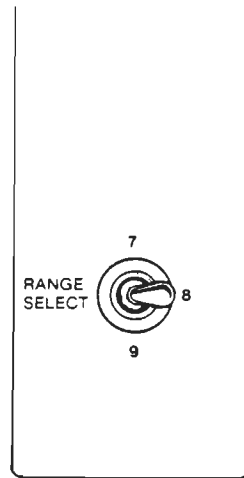

B. Correct Range Selection - Mid-Scale Display

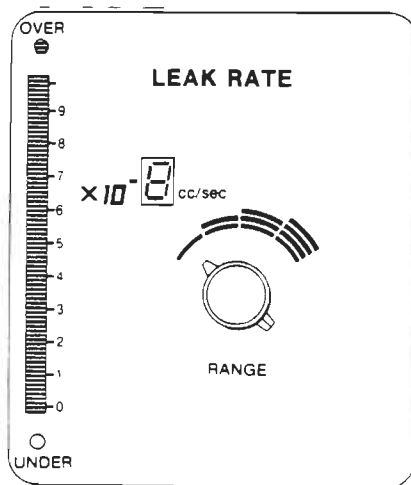
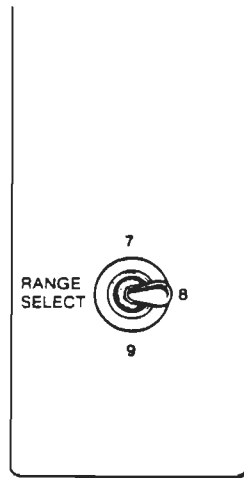

C. Over-Scale Condition - (Leak too large for this range)

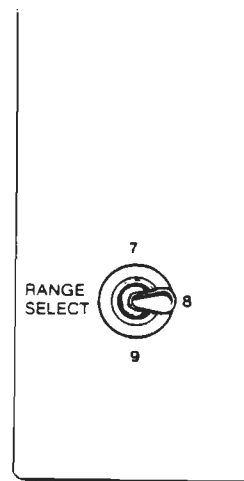

Fig. 3-6. Example of Range Selection for Leak Rate of 5×10^{-7} cc/sec

Table 3-3. Preferred Initial Setting of RANGE SELECT Switch and D.P. CONTROL Dial for Tuning

Range of Test Object Leak Specification (cc/sec)	Calibration Leak Selection				Tuning Leak	Preferred Initial Position of RANGE SELECT Switch	Preferred Initial Position of D.P. CONTROL
	Helium Reservoir Leak		Capillary Leak				
	10 ⁻⁸	10 ⁻⁷	10 ⁻⁵	10 ⁻⁴			
10 ⁻⁴		x	x	x	x	7*	Full ccw
10 ⁻⁵	x	x	x	x	x	7*	Full ccw
10 ⁻⁶	x	x	x	x	x	8	12 o'clock
10 ⁻⁷	x	x	x	x	x	8	12 o'clock
10 ⁻⁸	x	x				9	3 o'clock
10 ⁻⁹	x	x				9	3 o'clock
10 ⁻¹⁰	x	x				9	3 o'clock

*This is the position for finding relatively large leaks. Emission adjustment will be required for direct readout during calibration (see paragraph 3.4.3).

3.4.2 Using Calibration Leak for Tuning

The calibration leak can be used for two functions: (1) tuning the spectrometer tube; and (2) calibrating the leak detector. These two functions are normally performed at the same time, in the sequence indicated.

To tune the spectrometer tube, using a helium reservoir calibration leak, proceed as follows:

1. Turn the operating handle clockwise from the TEST position to the VENT position.
2. Unplug the test port, then install the calibration leak and tighten. Open the valve in the leak (one full turn). (Note: Reasonable hand-tightness is sufficient to compress the O-ring and establish a vacuum-tight seal in the test port.)
3. Turn the operating handle clockwise to the START position. The mechanical pump will sound louder for a brief interval. (This is the "rough" pumping stage.)
4. When the test port pressure reaches 100 milliTorr, turn the operating handle to the TEST position. Vacuum communication is now established between the test port and the spectrometer tube.
5. Observe the leak-rate indication on the vertical bar graph. It will probably be less than that of the calibration leak. If necessary, move the RANGE switch for an "on-scale" reading.
6. Close the valve on the calibration leak. There will be a decrease in the leak-rate when the valve is closed.
7. If required, carefully rotate the fine zero adjustment, labelled ZERO, to obtain a zero reading on the leak-rate display.* If necessary, open the access door and also rotate the coarse zero adjustment, labelled COARSE ZERO, to obtain a zero reading on the leak-rate display.
8. Reopen the valve on the calibration leak and observe the leak-rate display. If some value is displayed, turn the RANGE switch and attempt to position the reading between 1 and 9 on the bar graph.

*When adjusting the leak-rate fine zero control, it should be noted that a zero band covering between +2% and -4% of full-scale deflection relative to zero has been incorporated into the design of the instrument in order to eliminate possible ambiguous interpretation. When the signal falls within this zero band, the first segment LED (zero) will be lit. Signals below -4% will cause the under-scale LED to be lit, while those greater than +2% will cause the appropriate number of segment LEDs to be lit (2% of full scale per LED).

9. Gently adjust the FOCUS control (in both directions) for a maximum peak on the leak-rate display. Then gently adjust the ION control for a maximum peak on the leak-rate display. (Note: The ION control is a 10-turn potentiometer and normally should only have to be adjusted slightly for maximum peaking on the display.)
10. Slowly rotate the large black knobs on the spectrometer tube through 360° to find the respective points at which the leak-rate reading is the greatest. Leave each knob at the position of greatest indication. (NOTE: It is possible to rotate each knob beyond 360° and thus repeat the high-low readings. This is not recommended, since the knobs are preset at maximum at the factory prior to shipment and may only require very minor adjustment at the user facility. This adjustment is normally needed only after a new ion source has been installed.)
11. A change in one adjustment may effect the others. Therefore, it may be necessary to repeat steps 6 through 9 until no significant change occurs in the leak-rate reading. The 938-41 is now tuned to helium. (When this is done carefully, the day-to-day changes will be very small, and subsequent tuning may only require slight adjustment of the CAL control. If slight adjustment of the CAL control cannot achieve the desired results, then it will be necessary to repeat steps 6 through 9 above.)

To tune the spectrometer tube, using a capillary type of calibration leak, follow the same procedure as for a helium reservoir calibration leak, except apply helium (from a source) as a substitute for opening the valve on the leak and remove helium as a substitute for closing the valve on the leak.

3.4.3 Using Calibration Leak for Calibration

1. To calibrate the leak detector, or to make the instrument more sensitive to find smaller leaks or less sensitive to find larger leaks, further adjustments may be made to increase or decrease the leak-rate indication. In this case, adjust the calibration control, labelled CAL, with the valve on the calibration leak open (helium applied), until the value associated with the calibration leak is read. If the value of the leak cannot be met (reading too low), then adjust the D.P. CONTROL clockwise 45°; if it cannot be met because the reading is too high (too sensitive), adjust the D.P. CONTROL counterclockwise 45°.
2. Wait approximately 20 minutes and then try to adjust the reading to the desired value using the CAL control (If necessary, turn the D.P. CONTROL another 45°, wait 20 more minutes, and then readjust, using the CAL control.)

NOTE

For those cases where the RANGE SELECT switch was initially set in position 7 (Table 3-3), it will be necessary to first set the CAL control to 9 o'clock, then adjust the EMIS control until the leak-rate display agrees with the standard calibration leak. Thereafter, if the RANGE SELECT switch is moved to position 8 or 9, readjust the EMIS control for a peak on the display, whereas in the 7 range it is less.

3. Turn the operating handle clockwise to the VENT position and remove the calibration leak. Always store the calibration leak with its valve open.

3.4.4 Using Tuning Leak for Tuning

The tuning leak is a specially designed adjustable needle valve in an adapter to fit the test port. When the valve is opened such that test-port pressure is 100 milliTorr, helium naturally present in the atmosphere (5 parts per million) will enter the leak detector, giving a leak rate reading of approximately 10^{-6} std cc/sec. Since this reading is about 10 times as large as with the reservoir type of calibration leak, it makes tuning of the spectrometer tube easier.

Proceed as follows:

1. Turn the operating handle clockwise from the TEST position to the VENT position.
2. Unplug the test port, then install the tuning leak and tighten. Close the valve in the tuning leak. (Note: Reasonable hand-tightness is sufficient to compress the O-ring and establish a vacuum-tight seal in the test port.)
3. Turn the operating handle clockwise to the START position. The mechanical pump will sound louder for a brief interval. (This is the "rough" pumping stage.)
4. When the test port pressure reaches 100 milliTorr, turn the operating handle to the TEST position. Vacuum communication is now established between the test port and the spectrometer tube. The test port pressure will continue to drop when vacuum communication is established.
5. Observe the leak-rate display. If necessary, carefully rotate the fine zero adjustment, labelled ZERO, to obtain a zero reading on the display. If zeroing cannot be accomplished with the fine adjustment, open the access door and rotate the coarse zero adjustment, labelled COARSE ZERO.
6. Very slowly open the valve in the tuning leak, by turning the micrometer handle counterclockwise, until the test port pressure rises to 100 milliTorr. Note the corresponding rise in the leak-rate indication. (If the SPECTROMETER TUBE pressure indication rises above the green band, which means that 100 milliTorr has been exceeded, the green FIL. indicator on the front panel will go out. In this case, close the tuning leak valve until the pressure indication returns to the green band. Then flip the FIL. switch momentarily to the ON position and readjust the valve in the tuning leak for a test port pressure reading of 100 milliTorr.
7. Observe the reading on the leak-rate display. Move the RANGE switch if necessary to position the reading between 1 and 9 on the bar graph.
8. Gently adjust the FOCUS control (in both directions) for a maximum peak on the leak-rate display. Then gently adjust the ION control for a maximum peak on the leak-rate display. (Note: The ION control is a 10-turn potentiometer and normally should only have to be adjusted slightly for maximum peaking on the display.)
9. A change in one adjustment may effect the others. Therefore, it may be necessary to repeat step 8 until no significant change occurs in the leak-rate reading. The 938-41 is now tuned to helium. (When this is done carefully, the day-to-day changes will be very small and daily adjustment may not be necessary. It may prove helpful to record the micrometer reading used during the tuning procedure.)
10. Turn the operating handle clockwise to the VENT position and remove the tuning leak.

A. Valve Operation - Vent Position

VENT

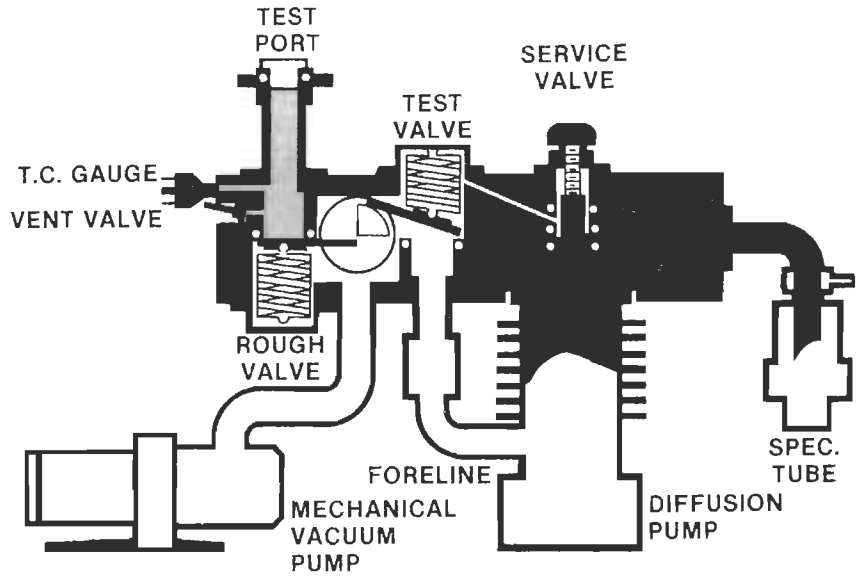
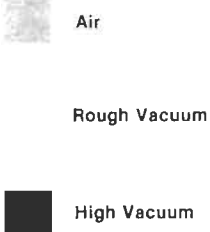
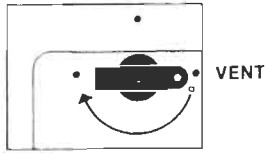

B. Valve Operation - Start Position

START

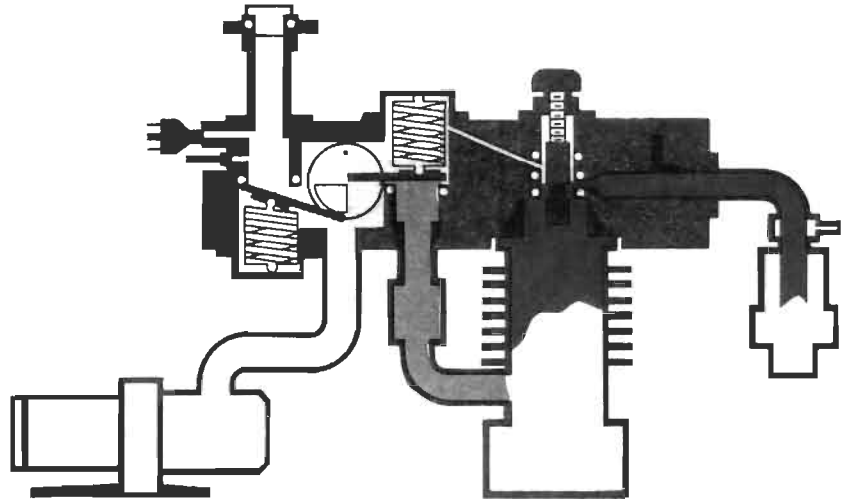
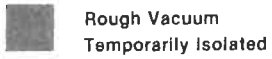
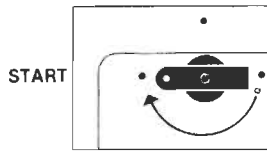

C. Valve Operation - Test Position

TEST

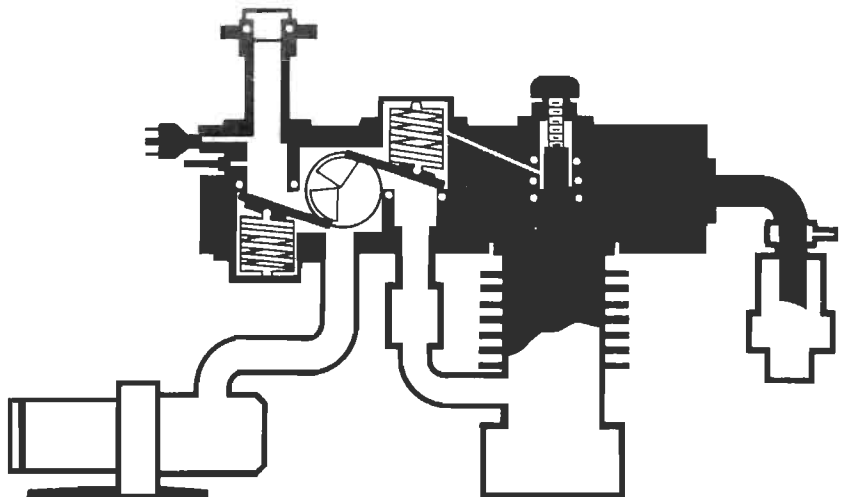
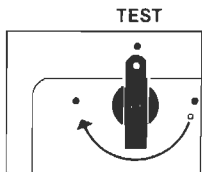

Fig 3-5. Valve Operation During Test Cycle
3-15

3.5 OPERATING PROCEDURES

3.5.1 Normal Test Cycle (100 milliTorr or less)

The test cycle is controlled by turning the operating handle clockwise to successive positions shown on the front panel (see Fig. 3-5). This automatically opens and closes valves in the right sequence in the valve block to enable the mechanical pump to be diverted from its usual job (as forepump to the diffusion pump) long enough to "rough" pump the test object. When the test port pressure is reduced to a safe level, the mechanical pump is again restored to its usual job as forepump, while continuing to pump the test object. Thus, a connection is now established between test object and spectrometer tube to enable the detection of leaks. Proceed as follows:

1. Verify that the operating handle is in the VENT position.
2. Secure the test object to the test port and make a vacuum-tight seal. (Note: Reasonable hand-tightness is sufficient to compress the O-ring and establish a vacuum-tight seal in the test port.)
3. Turn the operating handle clockwise to the START position. The mechanical pump will sound louder for a brief interval. This is the "rough" pumping stage, which takes several seconds to several minutes, depending on test object volume and mechanical pump capacity.

NOTE

Never leave operating handle in START position longer than 5 minutes.

4. When the test port pressure reaches 100 milliTorr, turn the operating handle clockwise to TEST position. (Vacuum communication is now established between test port and spectrometer tube.) If the pressure does not reach 100 milliTorr, see paragraph 3.5.3 or 3.5.4.
5. Apply helium sparingly to the test object.
6. Observe the indication on the leak-rate display, caused by helium entering any leaks that may be present. If no indication is observed, terminate the test. If desired, turn the RANGE switch to a smaller leak-rate range (counterclockwise) before concluding that the object is free of all leaks.
7. If desired, adjust the AUDIO control for an audible indication of any leaks.
8. When the leak test is complete, and the helium source is removed, the leak-rate display should drop to zero if a leak is present, and the audible alarm should be unnoticeable. At this point, turn the operating handle clockwise to the VENT position, then disconnect the test object.

3.5.2 Prolonged Pumpdown Cycle (Large Volume)

If, during the normal test cycle, the FIL. indicator goes out because of spectrometer tube overpressure while the operating handle is in the START (pumpdown) position (step 3 above), proceed as follows:

1. Turn the operating handle slowly counterclockwise to the detent position marked by a small white circle, just before VENT. This position connects the mechanical pump to the diffusion pump, without venting the test object, for restoration of high vacuum in the spectrometer tube.
2. Flip the FIL. switch momentarily to the ON position and release it. (The FIL. indicator will relight.)
3. Turn the operating handle clockwise to the START position to resume rough pumping.

Sometimes it will be necessary to repeat these steps before the test port pressure reaches 100 milliTorr. When it does reach 100 milliTorr, complete steps 4 through 6 as in the normal test cycle. If 100 milliTorr cannot be reached and you want to terminate testing, turn the operating handle counterclockwise through to VENT. Then remove the test object.

3.5.3 Testing at Higher Pressures (up to 350 milliTorr)

With the operating handle in the START position, if it is not possible to reach a test port pressure of 100 milliTorr despite the above two procedures, it may still be possible to conduct a helium leak test, provided a pressure of 350 milliTorr or less can be reached. Such a condition indicates a very large leak or excessive gas desorption ("outgassing"), or excessive test-object volume in relation to the mechanical pump capacity. Proceed as follows:

1. Turn the operating handle slowly counterclockwise to the detent position (small white circle) just below VENT.
2. Rotate the D.P. CONTROL fully counterclockwise. (At this point, the leak detector is tuned but not calibrated, and is set for finding larger leaks. Recalibrate the leak detector, if desired.)
3. Wait approximately 20 minutes.
4. Turn the operating handle clockwise to the START position.
5. When the test port pressure reaches 350 milliTorr, turn the operating handle to the TEST position, apply helium and observe the leak-rate indication as in the normal test cycle.

3.5.4 Testing at Higher Pressures (above 350 milliTorr)

With the operating handle in the START position, if it is not possible to reach a test port pressure of 350 milliTorr, turn the operating handle slowly counterclockwise to the VENT position and remove the test object.

Usually the fact that 350 milliTorr cannot be reached is, in itself, sufficient evidence for rejecting the test object as a leaker. However, the 938-41 can be used to detect leaks at higher pressures by using auxiliary equipment. This can be particularly useful when leak checking a vacuum process system operating at pressures well above 350 milliTorr. (See paragraph 2.6.4 for a description of this procedure.)

3.6 SHUTDOWN AND RESTARTING PROCEDURES

3.6.1 General

When leak testing is completed at the end of the day, it is general practice to leave the instrument in a **standby** condition, ready for operation the next day or after the weekend.

If the leak detector is not going to be used for an extended period (one or more weeks), then it is advisable to perform a **complete shutdown** in the interest of saving energy.

If the unit is to be moved to a remote location, and it is anticipated that it may be tipped over, then it is advisable to shutdown the leak detector and ready it for **transportation**.

The following paragraphs describe the procedure for handling each of the above shutdown conditions and for restarting the leak detector. Also included are instructions on how to handle power interruptions.

3.6.2 Shutdown for Overnight or Weekend (Standby)

With the mechanical pump running and the test port plugged (or "valved off"), turn the operating handle to the TEST or VENT position. Make certain that the spectrometer tube filament is turned on (green FIL. indicator should be lit).

3.6.3 Starting after Overnight or Weekend Shutdown (Standby)

No special steps are required for preparing the leak detector for operation. Assuming the green FIL. indicator is lit, indicating that the SPECTROMETER TUBE pressure is still in the green band, it is only necessary to peak tune the spectrometer tube (and calibrate the leak detector, if desired) using the instructions in paragraph 3.4.2, 3.4.3, or 3.4.4 and then running the normal test cycle as described in paragraph 3.5.1.

Should there have been a temporary power loss during the night or weekend, the green FIL. indicator will not be lit. The mechanical pump should be running and the SPECTROMETER TUBE pressure indication should be in the green band. In this case, flip the FIL. switch to the ON position and release. (This may have to be done several times.) The green FIL. indicator should light and remain that way. At this point, it is only necessary to peak tune the spectrometer tube (and calibrate the leak detector, if desired) using the instructions in paragraph 3.4.2, 3.4.3, or 3.4.4 and then running the normal test cycle as described in paragraph 3.5.1.

3.6.4 Complete Shutdown

In general, the leak detector can be left running with the operating handle in the TEST or VENT position, and the spectrometer filament energized. However, if it is desired to completely shut down the leak detector, proceed as follows:

1. Turn the operating handle to the VENT position and open the test port.
2. Move the ELECT. switch to the off position (down).

3. Turn the operating handle to the START position, then quickly remove power from the mechanical pump. Then set the MAIN POWER switch to the off position (down). (In the case of the cart-mounted leak detector, turn the operating handle to the START position, then quickly throw the circuit breaker at the bottom rear of the cart to the off position. When this circuit breaker is off, power will be removed from both the mechanical pump and the leak detector simultaneously. Then set the MAIN POWER switch on the leak detector to the off position.)

NOTE

A slight oil mist will issue from the mechanical pump when it is shut down.

4. Plug the test port.

NOTE

It is very important to maintain the operating handle in the START position. This will preserve vacuum in the system.

3.6.5 Starting after Complete Shutdown

To start the leak detector after a complete shutdown, proceed as follows:

1. Make sure that the test port is plugged.
2. Verify that the service valve on the back panel is in the operating position (backed off about $\frac{1}{8}$ turn from the fully clockwise position).
3. Verify that the mechanical pump is plugged into an ac outlet and that the vacuum connection to the leak detector is secure. Then turn on the mechanical pump and move the MAIN POWER switch to the ON position. (For the cart model, it may only be necessary to activate the circuit breaker at the bottom rear of the cart. Then set the MAIN POWER switch on the leak detector to the ON position.)
4. Turn the operating handle clockwise to the TEST position.
5. Observe the test port pressure indication on the horizontal bar graph. The indication should gradually go down to below 50 milliTorr.
6. After 30 minutes, set the ELECT. switch to the ON position. The SPECTROMETER TUBE pressure indication* should now be in the green band. If not, set the ELECT. switch to off, wait 15 more minutes, and try again. (If the pressure reading is still full-scale, see Section V, Troubleshooting.)

*The spectrometer tube pressure indication is provided by the "cold cathode" vacuum gauge in the spectrometer tube. An electrical discharge occurs (similar to that in a neon sign) whose current is proportional to the amount of gas present. At atmospheric pressure the discharge will not occur, hence the pressure indication is zero. As the pressure drops, the discharge suddenly starts at about 1/3 of atmospheric pressure, creating a full-scale reading which prevails until the pressure drops below 3 milliTorr (less than 1/100,000 atmospheric pressure). It is good practice to operate the gauge (electronics on) only for brief intervals, until the indication is in the green band. This prevents contaminative deposits that would be left by continuous operation at too-high pressures.

7. Flip the FIL. switch momentarily to the ON position, then release it. The green FIL. indicator on the front panel should light, indicating that the filament is energized and emitting electrons. It may be necessary to repeat this step several times before the filament stays on.
8. At this point it is only necessary to tune the spectrometer tube (and calibrate the leak detector, if desired) as described in paragraph 3.4.2, 3.4.3, or 3.4.4 and then run the normal test cycle as described in paragraph 3.5.1.

3.6.6 Shutdown for Transporting

To shut down the leak detector for transporting, proceed as follows:

1. Turn the operating handle to the VENT position and open the test port.
2. Move the ELECT. switch to the off position (down).
3. Turn the service valve on the back panel counterclockwise until it stops (about 7 full turns).
4. Turn the operating handle to the START position, then quickly remove power from the mechanical pump. Set the MAIN POWER switch to the off position. (In the case of the cart-mounted leak detector, turn the operating handle to the START position, then quickly throw the circuit breaker at the bottom rear of the cart to the off position. When this circuit breaker is off, power will be removed from both the mechanical pump and the leak detector simultaneously. Then set the MAIN POWER switch on the leak detector to the off position.)
5. Plug the test port, then disconnect the mechanical pump.

NOTE

It is very important to maintain the operating handle in the START position.

The above steps will preserve the vacuum in the spectrometer tube and the diffusion pump. Also, they prevent loss of pump fluid. The entire unit can now be packaged and transported.

3.6.7 Starting after Transporting

To start the leak detector after transporting, follow the start-up procedure in paragraph 3.3.

3.6.8 Power Interruption

There are three types of power interruptions to contend with: (1) temporary power losses that occur when the leak detector is in the standby condition; (2) power losses that occur while the leak detector is in a normal test cycle; and (3) interruptions that occur because of power surges and transients which result in activating the circuit breaker.

- Handling of a temporary power loss during standby is described in paragraph 3.6.3.

SECTION IV. MAINTENANCE

4.1 INTRODUCTION

Like other quality test equipment, a mass spectrometer leak detector requires periodic maintenance to ensure continued reliable operation. For simplicity, the maintenance functions in this section are grouped by recommended frequency, as shown in Table 4-1, based on assumed everyday use. This table also serves as an index.

Table 4-1. Scheduled Maintenance

Paragraph	Description	Daily	Weekly	6 Mos.	12 Mos.
4.2.1	Calibration check and tuning adjustments	X			
	Auxiliary mechanical vacuum pump				
4.3.1	Check oil level		X		
4.4	Change oil			X	
4.5	Complete overhaul, including:				
	Diffusion pump				X
	Spectrometer tube				
	Valve block assembly				

Most of these functions are self-explanatory. All of them can be carried out at routine intervals, as indicated. The sensitivity should always be checked at least once a day. However, other functions may be carried out either more or less often as shown, depending upon the extent of use of the leak detector.

Some maintenance functions may be required on a demand basis; for example, changing an ion source after filament failure. These are listed in Table 4-2. (They are also included in the complete overhaul.)

Table 4-2. As-Required Maintenance

Paragraph	Function	Most Common Symptom
4.4	Mechanical pump oil change	Unable to pump below 50 milliTorrr because of contaminated oil
4.6.2	Spectrometer tube cleaning	Loss of sensitivity or increase in background or tuning is high on ion dial (near 10)
4.6.3	Ion source replacement	Filament failure (whenever convenient after second filament is in use)
4.6.4	Cold cathode gauge cleaning	Instability in spectrometer tube pressure and leak-rate display (also whenever ion source is replaced)

Maintenance functions related to the mechanical assemblies are covered in paragraphs 4.2 to 4.6. Maintenance functions related to the electrical or electronic assemblies are covered in paragraph 4.7. Paragraph 4.8 tells how to check the leak detector itself for possible leaks.

NOTE

When servicing the leak detector or any vacuum equipment, cleanliness is vital. There are some techniques more important in leak detector servicing than in general vacuum work. They are:

1. Do not use silicone oil or silicone grease. (Although these products are generally excellent for vacuum systems, they cause loss of sensitivity in mass spectrometer leak detectors through build-up of invisible insulating layers in the spectrometer tube.)
2. Wipe all O-rings clean before installation to ensure that no foreign matter is present to impair the seal. Normally it is unnecessary to use vacuum grease. (If vacuum grease or diffusion pump oil is used, avoid silicone types, use sparingly, and wipe the O-rings "shiny" dry.) Apiezon L* (Varian Part No. 5000-6954-00-004) is excellent.

4.2 DAILY MAINTENANCE

4.2.1 Leak Detector Sensitivity Check

1. Perform calibration check and tuning adjustments as described in paragraph 3.4.
2. If specification cannot be met, refer to Section V, Troubleshooting.

4.3 WEEKLY MAINTENANCE

4.3.1 Oil Level (Auxiliary Mechanical Vacuum Pump** Only)

Check sight glass. If oil level is low, add fresh mechanical pump oil until the level is between the marks in the sight glass, when the pump is not running.

4.4 SEMI-ANNUAL MAINTENANCE

4.4.1 Mechanical Pump Oil Change - Quick Way

Change the auxiliary mechanical pump oil every six months or if unable to pump below 50 milli Torr because of oil contamination. Use these instructions only if confident that oil change can be completed within 10 minutes. The leak detector diffusion pump must be hot; otherwise, use the procedure in paragraph 4.4.2.

Tools: Pliers, funnel, drain pan

Parts: Pump oil, Varian Part No. 5027-6954-27-008 (one gallon)

Proceed as follows:

1. Turn operating handle to VENT. Then open the test port (unplugged).
2. Place ELECT switch in off position (down).

*Included in Spare Parts Kit (0981-K7642-801)

**Varian Part No. 5027-6954-27-008

3. Turn operating handle to START, then quickly shut off the mechanical pump (by means of its associated power switch). **Important:** leave operating handle in START position.
4. Drain the mechanical pump oil, as follows:
 - a. Place drain pan under drain plug, then turn on the mechanical pump.
 - b. Remove the drain plug.
 - c. Place palm of hand over mechanical-pump air outlet hole. This will force oil out of the pump.
 - d. When oil has been completely removed, shut off the mechanical pump.
5. Reinstall drain plug and add one cup of fresh oil through fill plug.
6. Repeat steps 4 and 5 above until oil runs clean.
7. With drain plug reinstalled, refill pump with fresh clean oil. Fill until oil level is in middle of sight glass when pump is running. Reinstall fill plug.
8. With mechanical pump running, close test port (plugged). When test port pressure reaches 100 milliTorr, turn operating handle from START to TEST.
9. Place ELECT. switch in ON position.
10. Place FIL. switch in ON position. Associated green FIL. lamp on front panel should light, indicating that the filament is energized and emitting electrons. The 938-41 Leak Detector is now ready to operate (see paragraph 3.4).

4.4.2 Mechanical Pump Oil Change — Complete Shutdown

Use these instructions for the mechanical pump oil change when the leak detector diffusion pump is not hot. It is necessary to change the mechanical pump oil every six months or if unable to pump below 50 milliTorr because of oil contamination.

Tools: Screwdriver, pliers, funnel, drain pan.

Parts: Pump oil, Varian Part No. 5027-6954-27-008 (one gallon).

Proceed as follows:

1. Turn operating handle to VENT. Then open the test port (unplugged).
2. Place ELECT. switch in off position (down). Also place MAIN POWER switch in off position.
3. Turn operating handle to START, then quickly shut off the mechanical pump (by means of its associated power switch). **Important:** Leave operating handle in START position.
4. Drain the mechanical pump oil, as follows:
 - a. Place drain pan under drain plug, then turn on mechanical pump.
 - b. Remove the drain plug.
 - c. Place palm of hand over mechanical-pump air outlet hole. This will force oil out of the pump.
 - d. When oil has been completely removed, shut off the mechanical pump.
5. Reinstall drain plug and add one cup of fresh oil through fill plug.

6. Repeat steps 4 and 5 above until oil runs clean.
7. With drain plug reinstalled, refill pump with fresh clean oil. Fill until oil level is in middle of sight glass when pump is running. Reinstall fill plug.
8. With test port plugged, turn on mechanical pump.
9. With ELECT. switch off, turn operating handle on front panel clockwise to TEST position.
10. Place MAIN POWER switch in ON position.
11. Wait 30 minutes for diffusion pump to reach operating temperature.
12. Place ELECT. switch in ON position. The SPECTROMETER TUBE pressure indication should now be in the green band. If not, place ELECT. switch in off position, wait 15 more minutes, and try again. If the pressure indication is still well above the green band, see Section V, Troubleshooting.
13. Place FIL. switch in ON position. Associated green FIL. lamp on front panel should light, indicating that filament is energized and emitting electrons. The 938-41 Leak Detector is now ready to operate (see paragraph 3.4).

4.5 ANNUAL MAINTENANCE (COMPLETE OVERHAUL)

4.5.1 General

After prolonged use, the leak detector will accumulate contaminants from even the "cleanest" of products tested. These contaminants will eventually impair operation. A thorough dismantling and cleaning of the vacuum system (including the spectrometer tube) will restore normal operation.

The following procedures, if done annually (for a leak detector in daily use) will prevent deterioration and sustain a high level of performance. For heavy production use, more frequent overhauls may be desirable; conversely, lighter use may permit a longer period between overhauls. In most cases, this work is done by user maintenance personnel, but it may also be done by Varian under the terms of a service contract.

The complete overhaul is detailed in the following paragraphs and includes:

Diffusion pump cleaning	Paragraph 4.5.2
Spectrometer tube cleaning	Paragraph 4.5.3
Valve block cleaning	Paragraph 4.5.4

The following tools and parts are required during overhaul:

Tools: Screwdrivers (regular and Phillips), 9/16" open-end wrench, retaining ring pliers.

Parts: O-ring Kit (0981-K7641-801)*
 Santovac 5 diffusion pump fluid, 65cc (0981-6954-05-002)*
 Apiezon L Grease (5000-6954-00-004)*
 Ion Source (0981-82850-301)*
 O-rings, Parker No. 2-025, Buna-N (5 ea) (for spectrometer tube elements)
 Freon, methanol, lint-free cloth
 Fine abrasive paper, emery cloth**

*Included in Spare Parts Kit (0981-K7642-801)

**Do not use crocus cloth

4.5.2 Preparation

1. With operating handle in VENT position, place both ELECT. and MAIN POWER switches in off position (down).
2. Remove test port plug (1, Fig. 4-1).
3. Wait 20 minutes for diffusion pump to cool. If applicable, disconnect remote meter and loudspeaker.
4. On the cart model, shut down mechanical pump by placing the cart rear circuit breaker in the off position. Then disconnect the vacuum tubing (2,3) from valve block. Disconnect the power cord from the main power line. (If it is desired to remove the leak detector from the cart, remove the four screws (5), then lift the leak detector off the cart, as shown.)

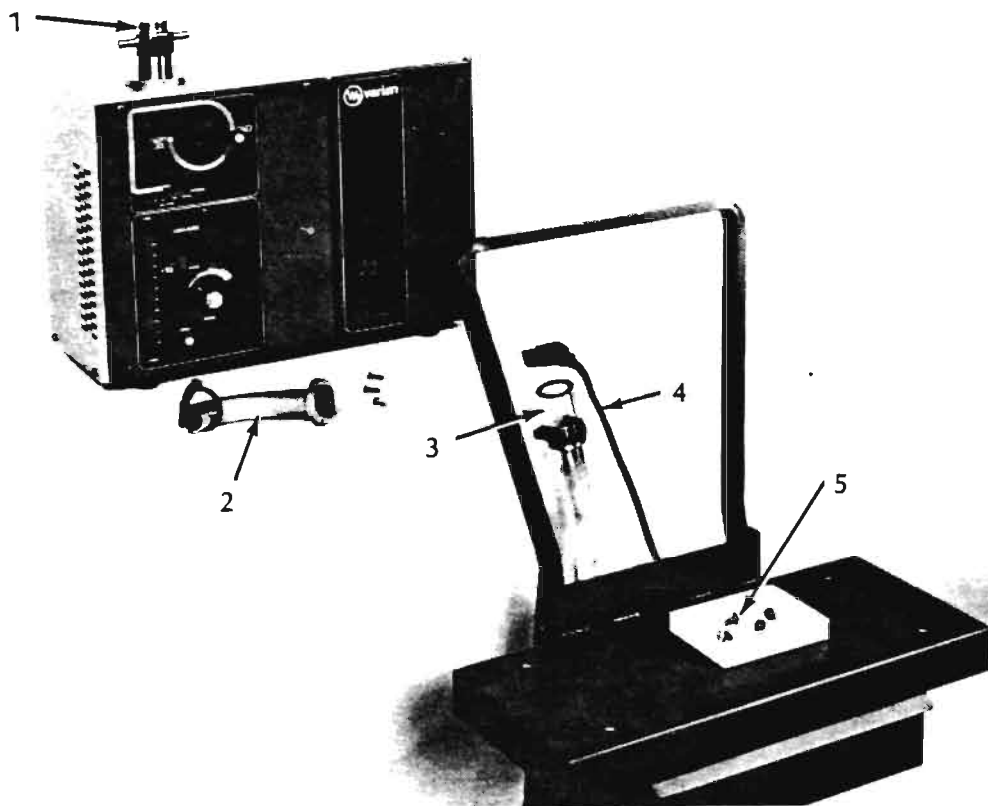

Key

- 1 Test Port Plug
- 2 Roughing Manifold
- 3 Vacuum Tubing
- 4 Power Cord for Leak Detector
- 5 Leak Detector Mounting Screws

Fig. 4-1. Varian 938-41 Leak Detector Removed From Cart

5. On the standard bench-model leak detector, shut down the mechanical pump by means of its associated power control. Then disconnect its power cord from the main power line. Disconnect the vacuum tubing from the valve block, then unplug the leak detector power cord from main power line.
6. Turn operating handle clockwise to TEST position. This will vent the diffusion pump.
7. Turn operating handle clockwise to 6 o'clock position. The rough and test valves will be closed. (This minimizes spring tension on both valves inside valve block for easier disassembly).
8. Remove test port cap (3, Fig. 4-2), O-ring, (5), O-ring follower (14), and test port nut (6).
9. Remove eight screws (1, Fig. 4-2) and (1, Fig. 4-3) that hold cover assembly (7, Fig. 4-2) to chassis and front panel. Slide cover assembly up and off unit.
10. Remove operating handle (5, Fig. 4-4) after first removing screw (4).

Key

- 1 Screw
- 2 Test Port Plug
- 3 Test Port Cap
- 4 O-Ring Follower
- 5 O-Ring
- 6 Test Port Nut
- 7 Cover Assembly

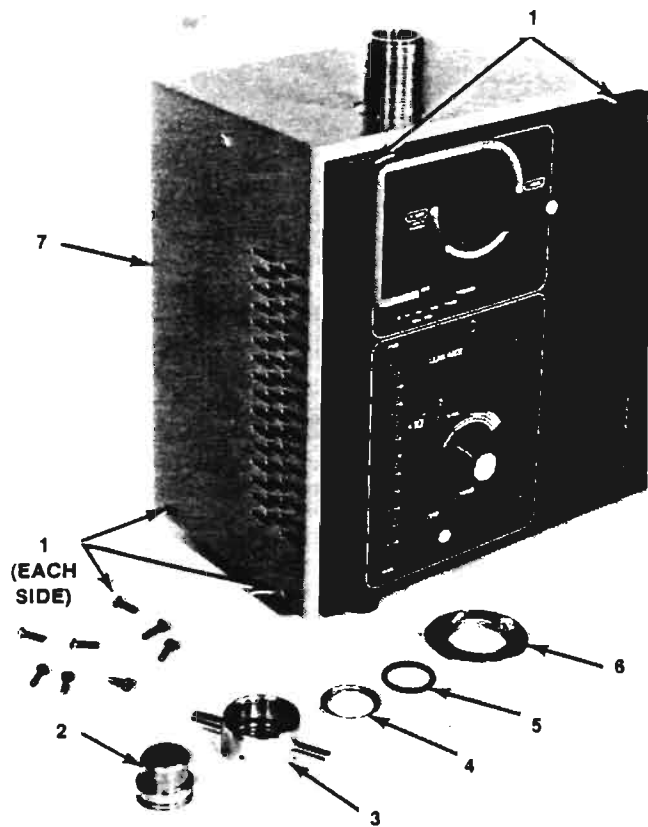

Fig. 4-2. Test Port Components Removed

Key

- 1 Screws for Cover Assembly
- 2 Electrical Cord for Thermocouple
- 3 Screws for Valve Block
- 4 Screws for High-Voltage Enclosure
- 5 Service Valve

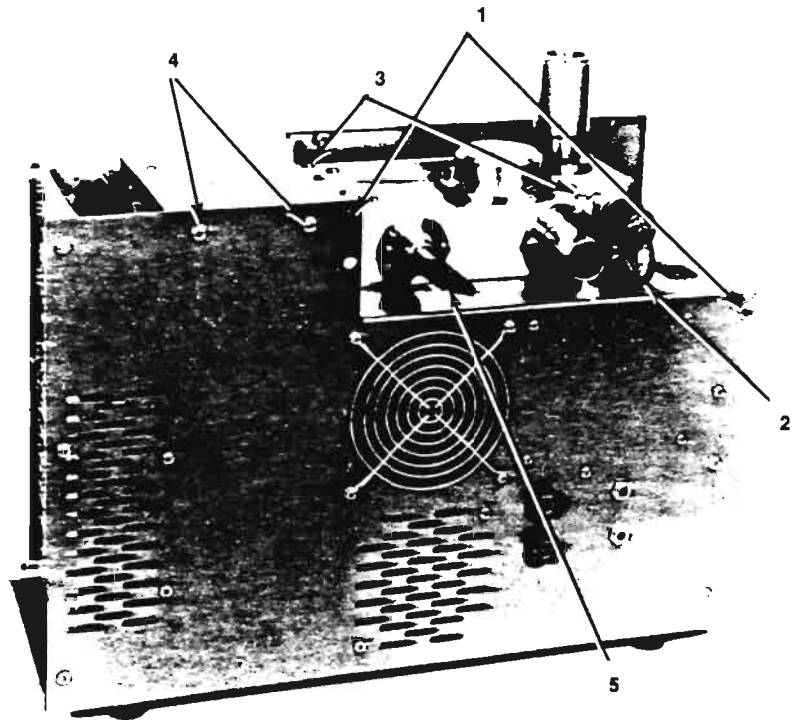

Fig. 4-3. Rear View of Leak Detector, Cover Removed

4.5.3 Removing the Vacuum System

1. Remove two screws (6, Fig. 4-4) and swing main electronics assembly (3) all the way to the right.
2. Remove two screws (4, Fig. 4-3) behind high voltage enclosure (2, Fig. 4-4) and then swing enclosure clockwise (upward) to the 90-degree position.
3. Remove three electrical plugs at top of spectrometer tube (7). Then unplug the spectrometer tube heater.
4. Unplug the diffusion pump power cord.
5. Remove four screws (3, Fig. 4-3) at corners of valve block. (Screws are #10-32 x 2½" long.)
6. Disconnect thermocouple gauge electrical cord (2).
7. With front panel pulled forward, lift valve block assembly out of leak detector, with diffusion pump and spectrometer tube intact (Fig. 4-5). Take care not to hit any electrical components, and be especially careful of the diffusion pump thermostat.
8. Disconnect diffusion pump (3) from valve block assembly (4) by removing three 2-inch long screws (5).
9. Disconnect spectrometer tube by removing KF flange (6). You now have three separate assemblies: valve block, diffusion pump, and spectrometer tube.

Key

- | | |
|--------------------------|------------------------|
| 1 Screw | 6 Screw |
| 2 High-Voltage Enclosure | 7 Spectrometer Tube |
| 3 Main Electronics Assy | 8 Potentiometer (R16) |
| 4 Screw | 9 Potentiometer (R58) |
| 5 Operating Handle | 10 Potentiometer (R65) |

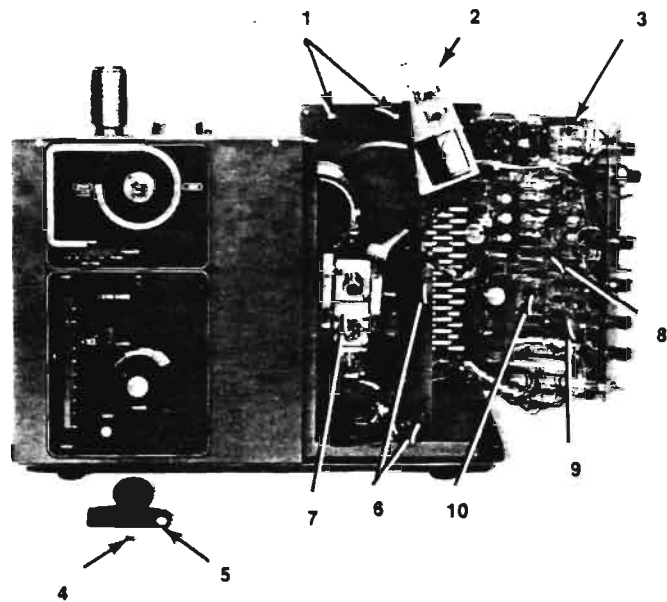

Fig. 4-4. Leak Detector With Cover Removed and Main Electronics Assembly Swung Open

Key

- | | |
|---------------------|------------|
| 1 Screw | 5 Screw |
| 2 Spectrometer Tube | 6 KF Clamp |
| 3 Diffusion Pump | 7 KEPS Nut |
| 4 Valve Block | 8 KEPS Nut |

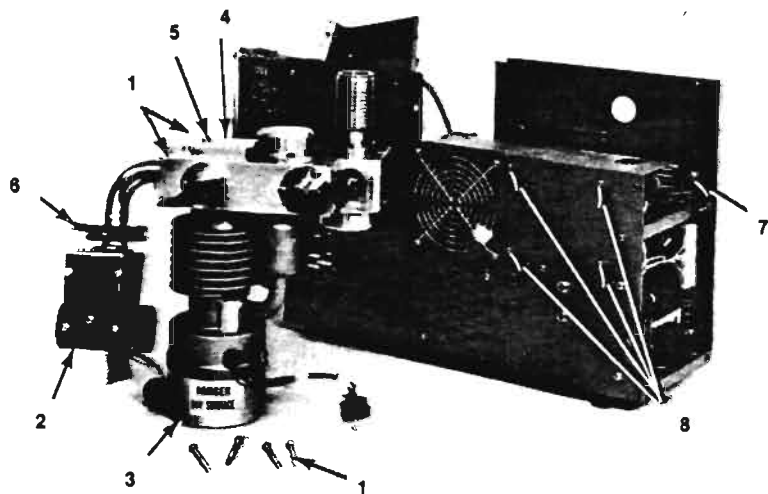

Fig. 4-5. Valve Block, Diffusion Pump, and Spectrometer Tube Removed From Cabinet

⚠ CAUTION

Freon TF and other solvents degrade O-ring materials reducing their ability to hold vacuum. Do not use Freon TF or other solvent on O-rings. If necessary to clean O-rings, wipe with lint-free, clean cloth or use a small amount of diffusion pump fluid just to make O-rings shiny. Do not use Alconox or any strong detergent when cleaning aluminum.

4.5.4 Diffusion Pump Cleaning

1. Remove retaining ring (5, Fig. 4-6), using a small screwdriver or retaining ring pliers.
2. Remove baffle (4), spring (3), and jet assembly (2).
3. Pour out and discard used pump fluid.
4. While pump is warm (heated by plugging in pump for 2-3 minutes), rinse the body and foreline with Freon until there are no visible traces of old pump fluid. Then rinse with methanol and dry.
5. Dismantle jet assembly. Clean and rinse as above. Fine abrasive paper may be used to clean baked-on deposits.
6. Reassemble jet assembly.
7. Clean and rinse baffle.
8. Reassemble diffusion pump, using new O-rings (6, 7).
9. Pour in 65 cc of Santovac 5 diffusion pump fluid.
10. Lightly lubricate (with a drop of pump fluid) and install foreline O-ring.
11. Cover diffusion pump so foreign matter cannot fall into it.

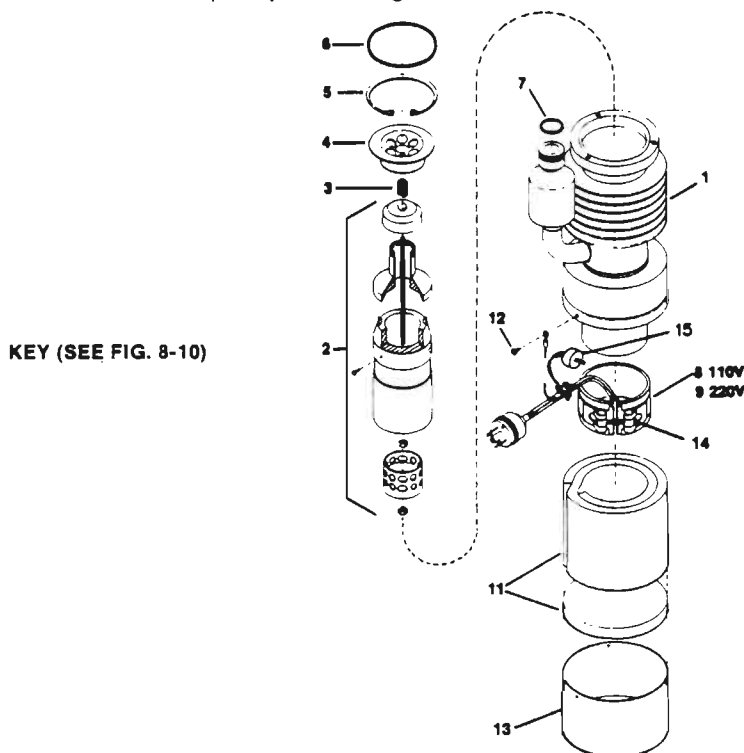

Fig. 4-6. Diffusion Pump, Exploded View

4.5.5 Spectrometer Tube Cleaning

Perform steps 6 through 20 of paragraph 4.6.2 (as-required spectrometer tube service).

4.5.6 Valve Block Cleaning

1. DISASSEMBLY (Discard all O-rings if new ones are available).

- a. Remove roughing manifold (27, Fig. 4-7), spectrometer tube manifold (28), and inlet manifold (26). NOTE: All screws are the same size and length.
- b. Remove thermocouple gauge (31), O-ring (5) and washer (32) by pulling straight out.
- c. Remove service valve assembly with all O-rings and spacers (16, 18, 19, 20).
- d. Remove test valve cap (13). (NOTE: Loosen screws evenly, as the cap is spring-loaded). Take out spring (12), valve seat (9), back-up ring (10), and O-ring (11).
- e. Repeat step d for rough valve.
- f. Remove $\frac{3}{8}$ nut (7) from cam shaft (2).
- g. Remove detent plate (6).
- h. Remove vent valve assembly (22, 23, 24).
- i. Push cam shaft (2) back and out of valve block (1).
- j. Remove two O-rings (5) from cam shaft (2).
- k. Remove two bearings (3) from cam shaft (2).

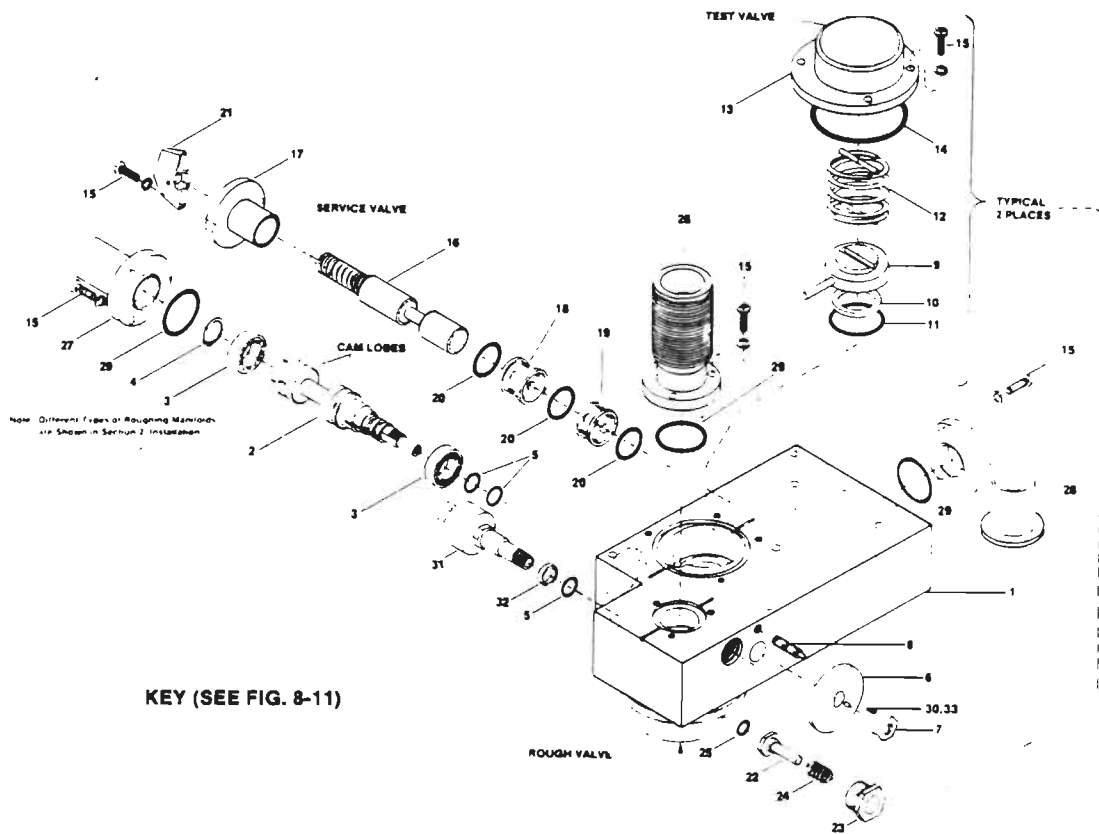

Fig. 4-7. Valve Block Assembly, Exploded View

2. Cleaning Valve Block

- a. Wash all parts, except thermocouple gauge (31, Fig. 4-7) and service valve handle (21), in Freon to remove all foreign matter and residual Apiezon grease. Dry thoroughly.
- b. Lightly coat cam shaft (2), bearings (3) and detent plate (6) with mechanical pump oil for rust protection.

3. Reassembling Valve Block

- a. Moisten all new O-rings with Apiezon L vacuum grease until they are shiny. The service valve O-rings (20) and cam shaft O-rings (5) must be lubricated liberally.
- b. Reassemble vent valve assembly (22, 23, 24).
- c. Assemble bearings (3) onto cam shaft (2) using snap ring (4) on end bearing. Install two O-rings (5) onto cam shaft. (NOTE: Fill O-ring grooves with Apiezon grease before installing O-rings.) Lubricate cam lobes with Apiezon grease (see Fig. 4-8).

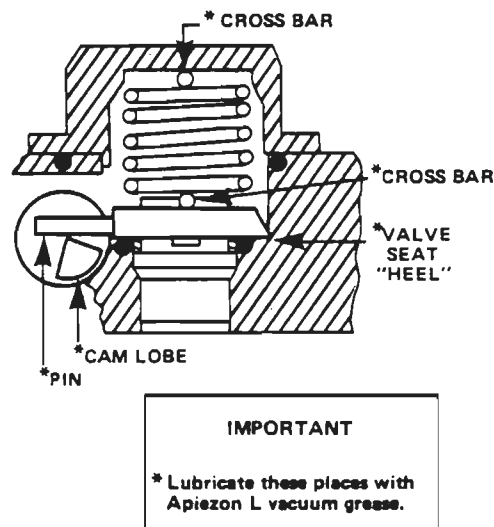

Fig. 4-8. Valve Lubrication

- d. Push cam shaft (2, Fig. 4-7) into valve block (1) through rough pump opening.
- e. Put $\frac{1}{2}$ drop of Apiezon grease into each detent on detent plate (6), then assemble plate onto cam shaft end using $\frac{3}{8}$ hex nut (7).
- f. Assemble rough valve assembly (Fig. 4-8) as follows: Install seat O-ring (11, Fig. 4-7) and backup ring (10). **Important:** Place one drop of Apiezon grease on "heel" of valve seat (9) and lubricate valve seat pin (which wears on cam shaft). Drop valve seat (9, Fig. 4-7) into cavity with pin riding on cam lobe. Lubricate cross bars on valve spring (12) with Apiezon grease. Place spring (12) into slot on valve seat. Place O-ring (14) into groove on valve body (1). Place valve cap (13) over spring (12) and screw down evenly.
- g. Install operating handle (21) temporarily to place cam position at 6 o'clock handle position.
- h. Assemble test valve assembly as in step f above.

- i. Assemble service valve assembly. Lubricate O-rings (20) liberally. Place an O-ring into cavity followed by the short spacer (19), then another O-ring (20) followed by a long spacer (18), then another O-ring. Coat the valve shaft (16) lightly with Apiezon grease and push it into place through the O-rings and spacers. Assemble end cap (17) and valve knob (21). Be sure to tighten screws evenly on end cap (17) with service valve all the way in. (This will line up the shaft properly.)
- j. Assemble thermocouple gauge (31) with washer (32) and O-ring (5).
- k. Assemble the spectrometer tube manifold (28), inlet manifold (26), and the roughing manifold (27).
- l. Temporarily install operating handle and rotate it a few times to test the "feel" of valve block assembly.

4.5.7 Installing the Vacuum System

1. Reconnect diffusion pump to valve block assembly, using three 2½" long screws (5, Fig. 4-5).
2. Place valve block assembly (with diffusion pump) into cabinet.
3. Bolt valve block assembly to cabinet, using four 2½" long screws (3, Fig. 4-3).
4. Install operating handle.
5. Plug in thermocouple gauge electrical cord.
6. Plug in diffusion pump electrical cord.
7. Install spectrometer tube (Fig. 4-9). Hold it at an angle, as shown. Attach the tube, using the KF flange.
8. Reconnect three electrical plugs on spectrometer tube. Then reconnect spectrometer tube heater cord.
9. Swing high-voltage enclosure (2, Fig. 4-4) downward, then secure with two screws (1).
10. Swing the main electronics assembly (3, Fig. 4-4) inward and secure with two screws (6).
11. Attach cover assembly to chassis and front panel, using eight screws (1, Fig. 4-2).
12. Reassemble test port cap (3, Fig. 4-2), O-ring (5), O-ring follower (4), and test port nut (6).
13. Mount leak detector on cart, if applicable.
14. Reconnect all power cords and vacuum tubing.

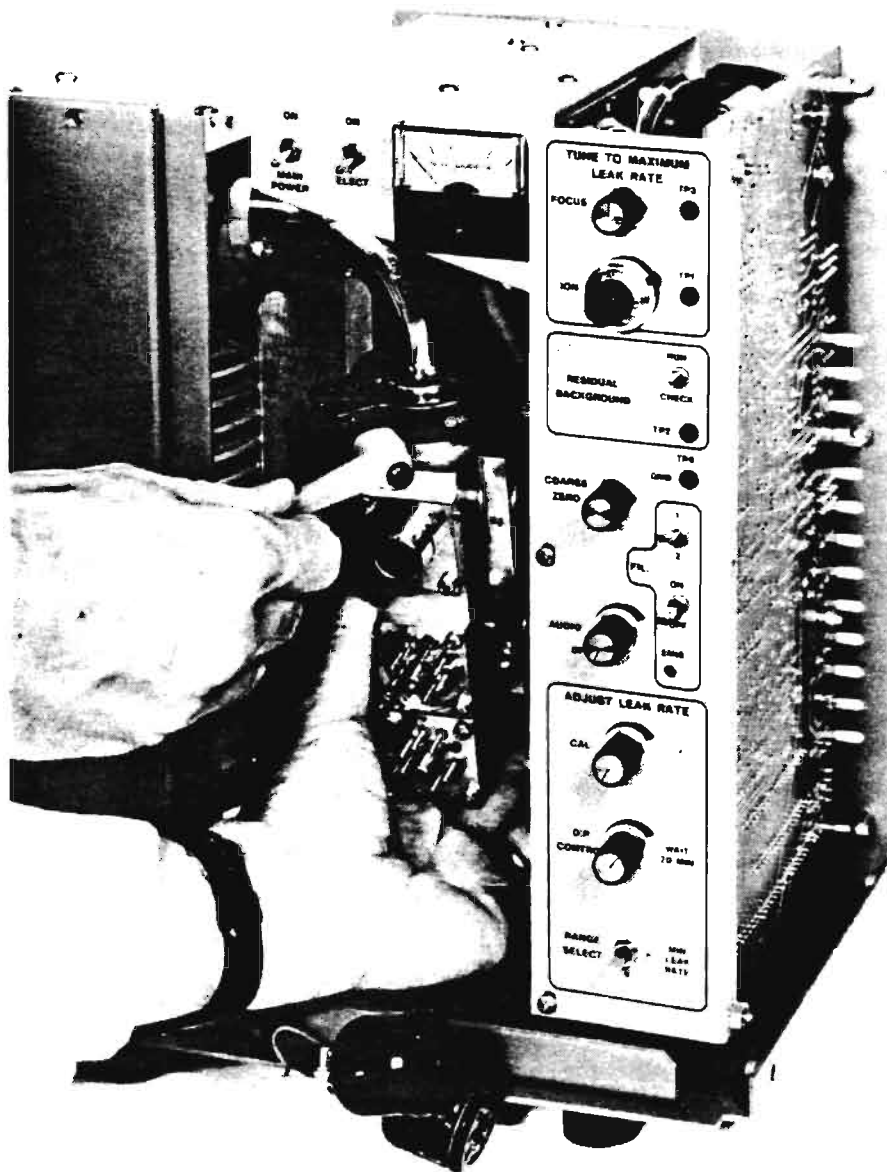

Fig. 4-9. Spectrometer Tube Removal By Releasing KF Clamp

4.5.8 Startup Procedure

1. Place plug in test port.
2. Place ELECT. switch in off position (down).
3. Verify that service valve (5, Fig. 4-3) is in operating position (backed off about $\frac{1}{8}$ turn from fully in clockwise position).
4. Turn operating handle on front panel clockwise to TEST position.
5. Verify the mechanical pump is connected to its associated power line but is not turned on. Also verify that there is a vacuum connection between leak detector and mechanical pump.
6. Turn on mechanical pump. Then place MAIN POWER switch in ON position. The test port pressure should gradually go down to 5-10 milliTorr.
7. Wait 30 minutes for diffusion pump to warm up.
8. Place ELECT. switch in ON position. As the pressure within the vacuum system is reduced, the SPECTROMETER TUBE pressure indication should now be in the green band. If not, place ELECT. switch in off position, wait 15 minutes, and try again. If the pressure indication is still well above the green band, see Section V, Troubleshooting.
9. Place FIL. switch in ON position. Associated green FIL. lamp on front panel should light, indicating that filament is energized and emitting electrons. The 938-41 Leak Detector is now ready to operate (see paragraph 3.4).

4.6 AS-REQUIRED MAINTENANCE

This type of maintenance is generally restricted to two mechanical assemblies: the spectrometer tube and the diffusion pump.

Paragraph 4.6.1 contains a procedure for replacing the diffusion pump heater after removing the pump from the cabinet.

Paragraph 4.6.2 contains a procedure for removing, cleaning, and reinstalling the spectrometer tube.

Paragraph 4.6.3 contains instructions for replacing the ion source while the spectrometer tube is removed from the cabinet.

Paragraph 4.6.4 contains instructions for cleaning the cold cathode gauge while the spectrometer tube is removed from the cabinet.

4.6.1 Diffusion Pump Heater or Thermostat Replacement

Tools: Screwdriver

Parts: Heater element, Part No. 0981-6473-09-150 (115 VAC)
Heater element, Part No. 0981-6473-09-155 (230 VAC)
Thermostat, Part No. 0981-6475-06-278

1. Remove screws (12, Fig. 4-6), then carefully pull off bottom cover (13) and insulation (11) from diffusion pump (mark hole line-up for reassembly).
2. Loosen screws (14), then remove band heating element and thermostat (8 or 9), noting position of wire leads and strain relief.
3. Install new heating element. Be sure there is no foreign matter between heating element and pump body. A good metal-to-metal contact is required. Tighten screw (14) securely.
4. Install new thermostat.
5. Reassemble insulation (11) exactly as it came off.
6. Slide bottom cover (13) over insulation (11) and secure with screws (12). Be sure tab on strain relief is inside bottom cover.

4.6.2 Removing, Cleaning, and Reinstalling Spectrometer Tube*

The spectrometer tube operates at a very high vacuum produced by the diffusion pump. Service of the spectrometer tube requires that this vacuum be vented to the atmosphere. However, the diffusion pump must be protected and this is accomplished by the service valve.

Tools: Phillips-head screwdriver.

Parts: Emery cloth, Freon TF, methanol, lint-free cloth, ion source (0981-82850-301), four O-rings (Parker No. 2-025, Buna-N)

1. With plug secured in test port and operating handle in VENT position, place ELECT. switch in off position (down).
2. Turn service valve counterclockwise (Fig. 4-10) until it stops in fully out position.

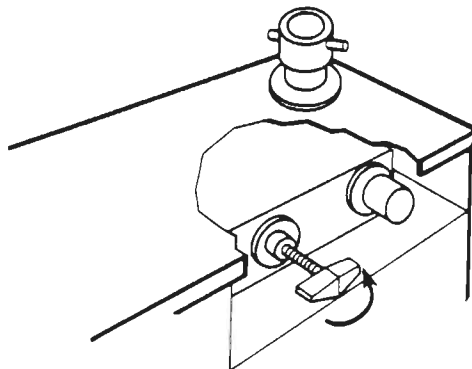

Fig. 4-10. Closing Service Valve (CCW Rotation)

3. Remove three electrical plugs at top of spectrometer tube (Fig. 4-4). Unplug spectrometer tube heater.
4. Remove KF flange (Fig. 4-9) on spectrometer tube and break vacuum connection. This is the SERVICE VENT position (Fig. 4-11A).
5. Remove spectrometer tube from cabinet (Fig. 4-12).
6. Remove three mounting screws (1, Fig. 4-12) and take off magnet assembly (Fig. 4-13).

▲ CAUTION

Do not disassemble the magnet assembly. Also, avoid placing the magnet on a steel or iron surface to prevent weakening the magnetic field.

*Rebuilt spectrometer tubes are available from Varian Lexington Vacuum Division on an exchange basis. Contact Varian Service Center for details.

7. Slide heater (5) out of its recess in tube body (2).
8. Remove cold cathode gauge (4, Fig. 4-14), ion source (5) and preamplifier (8). Discard ion source, but handle other two parts by flanged-pin end only, to prevent contamination by skin contact.
9. Slip out baffle (11) between cold cathode gauge and ion source cavities. Carefully remove ground slip plate (10) from ion source cavity, using "shoe hook" or thin screwdriver.
10. Remove four Phillips-head screws on each side of spectrometer tube body (2, Fig. 4-13) and slip out both pole pieces (4). Discard O-rings (3).
11. Using fine emery cloth, remove heavy deposits from all surfaces of baffle, ground slit plate, cold cathode gauge liner and anode loop, until bare metal surfaces are exposed. (NOTE: Do not use crocus cloth, as it leaves a residue.)

⚠ CAUTION



Under no circumstances should a chemical cleaner be used, especially strong detergents or alkaline cleaners. **Do Not Use Alconox or a similar type detergent.**

12. Rinse spectrometer tube body, pole pieces, baffle, ground slit plate, and cold cathode gauge parts in a Freon-type solvent (DuPont Freon TF or equivalent).
13. If foreign matter or stubborn stains remain, rub them with a plastic scouring pad such as "Bear-Tex" or "Scotchbrite" (very fine grade).
14. Rinse again in Freon-type solvent.
15. Use warm air to dry all parts.
16. Reassemble tube heater, pole pieces (using new O-rings), and magnet assembly. Pole pieces are interchangeable.
17. Install ground slip plate. (When installing ground slip plate, be sure that the prongs are facing up. Align slits at 90° with sidewalls of spectrometer tube and/or concentrically align circular hole in plate with smaller guide hole in bottom of ion source cavity.)
18. Install baffle.
19. Wipe new O-ring and mating surfaces with clean lint-free cloth and place new ion source in cavity. Locating pin should be approximately in center of guide hole. Be sure pins 1 and 8 are parallel to the sidewall of the spectrometer tube (Fig. 4-15). Tighten hold-down flange evenly and firmly. (A straight edge held against pins 1 and 8 of both octal arrays is a convenient way to assure parallelity.)
20. Install preamplifier and cold cathode gauge, using new O-rings. Tighten clamps evenly and securely.
21. Install spectrometer tube in cabinet, using KF flange and O-ring.
22. Reconnect three electrical plugs at top of spectrometer tube and reconnect spectrometer tube heater.
23. To evacuate spectrometer tube heater, turn operating handle to START.

A. Valve Operation - Service Vent

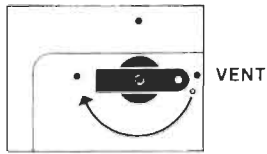
SERVICE VENT



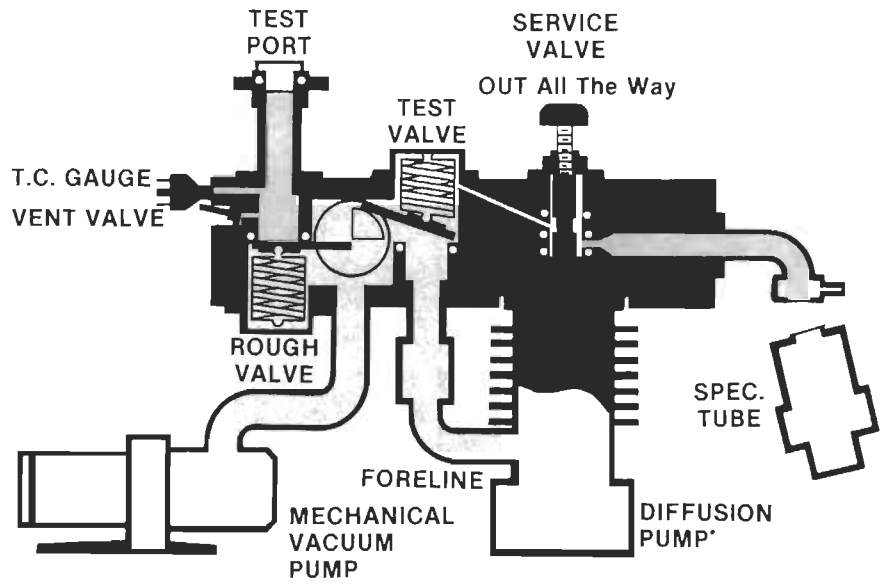

-  Air
-  Rough Vacuum
-  High Vacuum

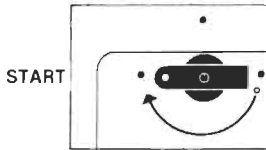

B. Valve Operation - Service Pump

SERVICE PUMP



-  Rough Vacuum Temporarily Isolated

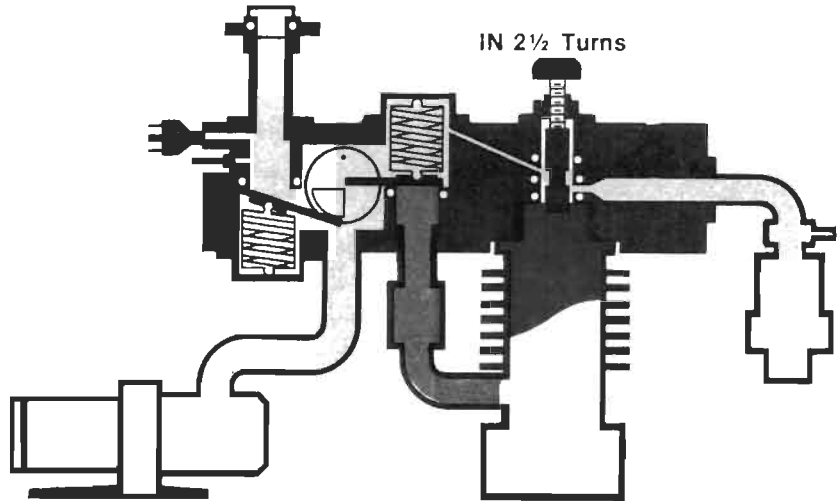

C. Valve Operation - Operate

OPERATE

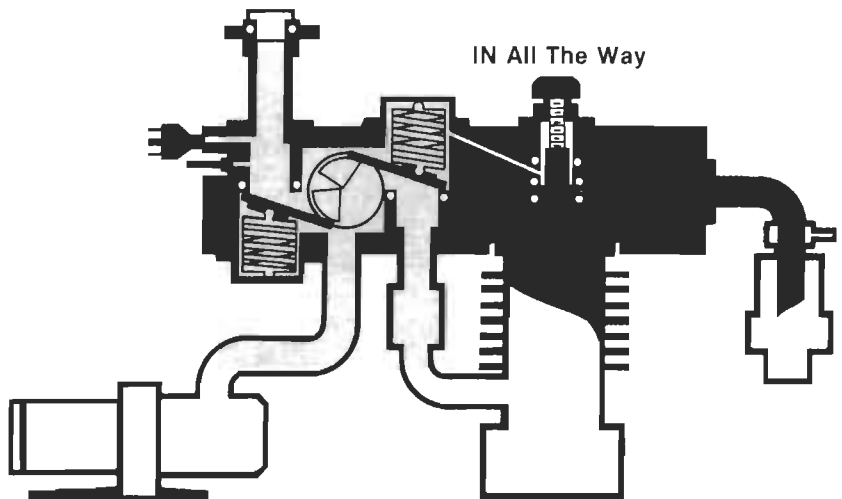
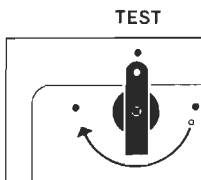

Fig. 4-11. Valve Operation During Service

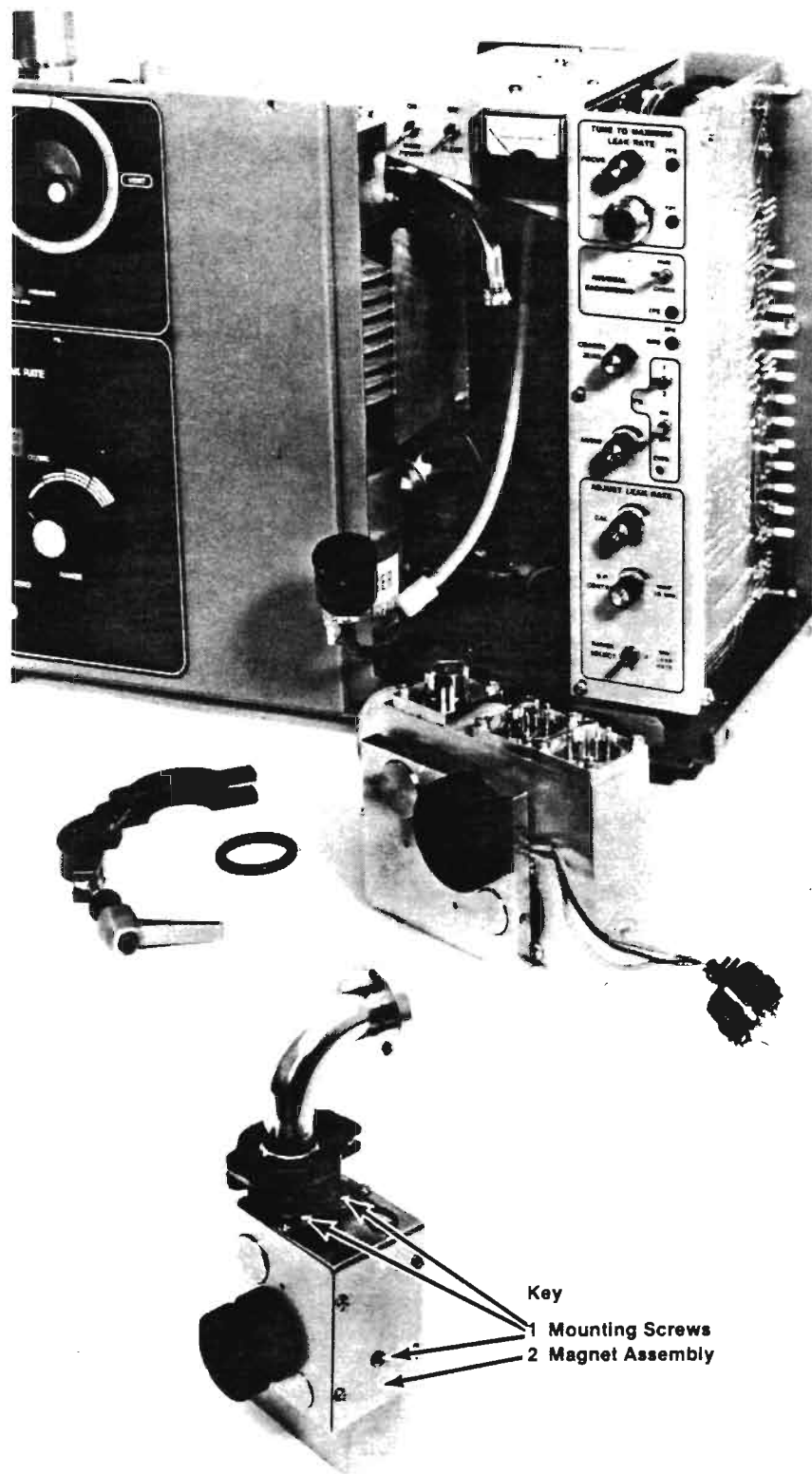

Fig. 4-12. Spectrometer Tube Removed From Cabinet

KEY (SEE FIG. 8-8)

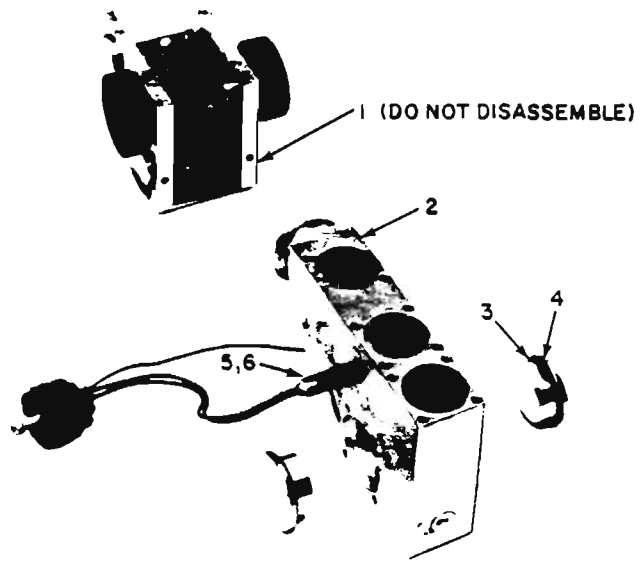

Fig. 4-13. Spectrometer Tube and Magnet Assembly

KEY (SEE FIG. 8-7)

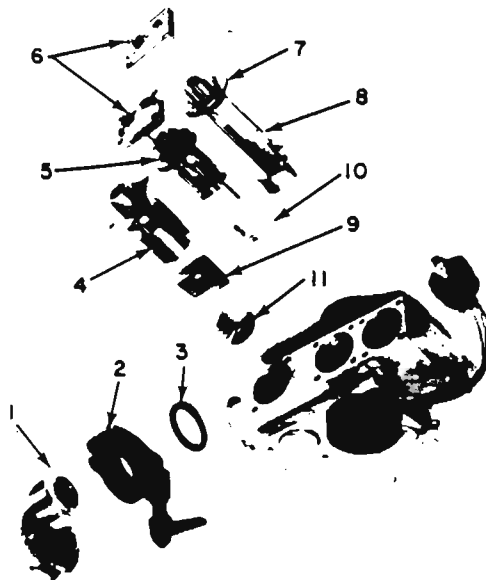

Fig. 4-14. Spectrometer Tube, Exploded View

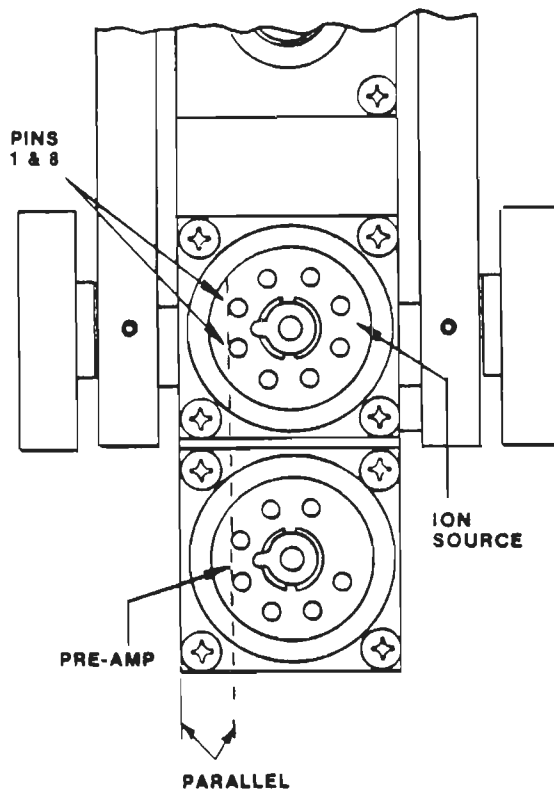

Fig. 4-15. Ion Source Alignment

24. Turn service valve clockwise $2\frac{1}{2}$ turns (Fig. 4-16). This is SERVICE PUMP position (Fig. 4-11B). When test port pressure reaches 20 milliTorr, turn service valve all the way in. Then back off $\frac{1}{8}$ turn.
25. Turn operating handle to TEST. This is the OPERATE position (Fig. 4-11C).
26. After two minutes, place ELECT. switch in ON position. If spectrometer tube pressure is in the green band, proceed to retune the leak detector as described in Section III.
27. For optimum operation, it is recommended that the leak detector be allowed to stabilize for two hours after cleaning the spectrometer tube. (Leave the ELECT. switch off to avoid possible contamination of the cold cathode gauge during this period.) Turn the diffusion pump control (D.P. Control) fully counterclockwise to condition the system more rapidly.

4.6.3 Ion Source Replacement

The ion source has two filaments. The spare is turned on by the filament selector switch (FIL. 1, 2) behind the access door. Slight retuning may be necessary to obtain maximum sensitivity. It is recommended that the ion source be replaced as soon as convenient after the spare has been put into use. (Replacement takes about 10 minutes.)

Tools: Phillips-head screwdriver.

Parts: Ion Source (Varian Part No. 0981-82850-301), emery cloth.

1. Perform steps 1-5 in paragraph 4.6.2.
2. Remove four screws that secure clamp (6, Fig. 4-14), then gently slide ion source (5) out of spectrometer tube body. Discard ion source.

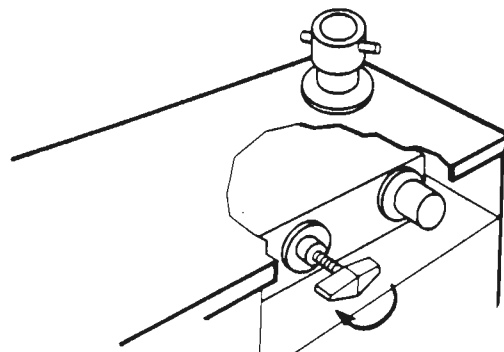

Fig. 4-16. Opening Service Valve

3. Inspect ground slip plate (10) and ion source cavity to verify that they are clean. If not, follow applicable instructions in steps 6 through 16 in paragraph 4.6.2 to clean the spectrometer body and the ground slit plate.
4. Perform applicable steps 17 through 26 in paragraph 4.6.2 to install ground slit plate and ion source, and to ready the leak detector for operation.

4.6.4 Cold Cathode Gauge Cleaning

This procedure is usually performed whenever the ion source is changed, but if it needs to be done independently, proceed as described below.

Tools: Phillips-head screwdriver.

Parts: Emery cloth.

1. Perform steps 1-5 in paragraph 4.6.2.
2. Remove four screws that secure clamp (6, Fig. 4-14), then gently slide cold cathode gauge out of spectrometer tube body.
3. Slip out cathode liner (2, Fig. 4-17). If liner is dirty, clean it with emery cloth, or replace it. If anode (4) must be removed, first remove side pole pieces, then very carefully twist the anode clockwise to loosen, while pulling to prevent cracking the ceramic feedthrough (3). This will appear to be screwing loop onto the pin. (This in fact loosens the grip of the anode onto the feedthrough.)
4. Install cold cathode gauge, preferably using new O-ring. Wipe O-ring and mating surface with clean lint-free cloth.
5. Follow steps 21 through 26 in paragraph 4.6.2 to restart and retune the leak detector.

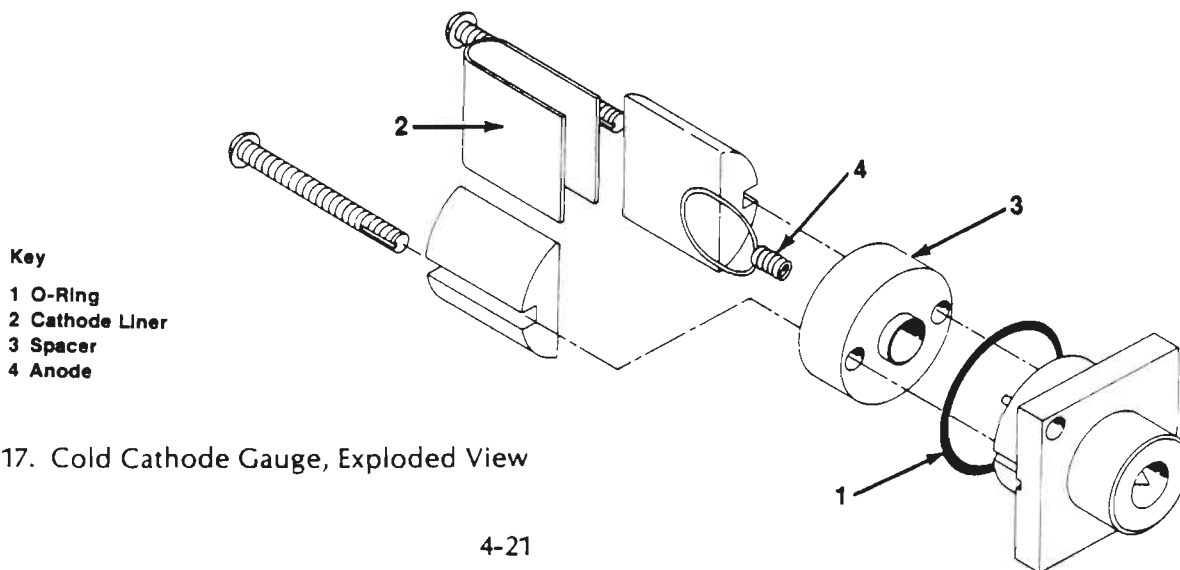

Fig. 4-17. Cold Cathode Gauge, Exploded View

4.7 ELECTRONICS SYSTEM

4.7.1 General

This manual is intended for user operation and maintenance and, as such, is limited to electronic adjustments and replacement at the printed-circuit (PC) board level. Fault isolation to a specific electronic component, such as a resistor or an integrated circuit, is covered in a separate service manual.* The service manual also contains detailed instructions for adjustments that must be made after one or more components is replaced.

The following adjustments are associated with the electronics in the 938-41 Porta-Test Leak Detector and should be made by the user when necessary:

1. Emission control adjustment
2. Adjustment of ion source voltages
3. Adjustment of thermocouple gauge
4. Overpressure protection adjustment
5. Display amplifier adjustment (leak rate)
6. Diffusion pump power adjustment
7. Residual background check

For all of the adjustments below, it is assumed that the leak detector has been previously started up as described in paragraph 3.3 and that the operating handle is in the TEST position. It is also assumed that there is a calibration or tuning leak in the test port.

4.7.2 Emission Control Adjustment

This front-panel screwdriver adjustment should be made after ion source replacement or whenever the user cannot achieve maximum sensitivity previously attainable. It may also be used to lower sensitivity significantly.

1. Follow the same tuning procedure as in paragraph 3.4.2 or 3.4.3 to adjust the FOCUS and ION controls.
2. Adjust the EMIS. control for a maximum peak on the leak-rate display.
3. Complete the rest of the tuning procedure.

4.7.3 Adjustment of Ion Source Voltages

It is sometimes important to know if the ion source tuning voltages have sufficient span or are in the correct range. This is especially true after ion source replacement or when it is not possible to tune the spectrometer tube so that it is sensitive to helium. Comparison with the table below will indicate if the voltages are in the correct range. Proceed as follows:

1. Set the ION and FOCUS controls fully counterclockwise (ccw).
2. Set the RESIDUAL BACKGROUND switch to the CHECK position.
3. Using a voltmeter with an input impedance of at least 100,000 ohms/volt, measure the ion voltage between test points TP1(+) and TP4(-) on the front panel. Then rotate the ION control fully clockwise and measure the voltage. The following readings should be obtained (± 10 percent):

TP1	Ion Voltage	ccw = 160 vdc
		cw = 330 vdc

Leave the ION control in the fully clockwise position.

4. Measure the repeller voltage between TP2(+) and TP4(-). Then move the RESIDUAL BACKGROUND switch to the RUN position. The following readings should be obtained (± 10 percent):

TP2	Repeller Voltage	CHECK = 330 vdc
		RUN = 430 vdc

Leave the switch in RUN position.

5. Measure the focus voltage between TP3(+) and TP4(-). Then rotate the FOCUS control fully clockwise and measure the voltage. The following readings should be obtained (± 10 percent):

TP3	Focus Voltage	ccw = 310 vdc
		cw = 250 vdc

If all the voltages are within the designated ranges, the ion source should be working properly. It may then be necessary to readjust the ION and FOCUS controls in order to properly tune the spectrometer tube. If one or more of these voltages remains out of range, see Section V, Troubleshooting.

4.7.4 Adjustment of Thermocouple Gauge

This procedure should be followed if a new 531 thermocouple gauge is installed or if the thermocouple calibration has drifted. The leak detector should be operating with the diffusion pump running, the ELECT. switch in the ON position, and the thermocouple gauge installed.

1. Remove the cabinet cover and access the main electronics assembly. To access the main electronics assembly, remove the two Phillips-head screws located at the center partition (Fig. 4-4). Then swing the assembly out and locate potentiometer R16.
2. With the operating handle in the TEST position, adjust R16 until the second segment on the test port pressure display is illuminated. (This will be the second segment on the left of the horizontal display.) The first segment is on all the time and will not go out.
3. If other adjustments are to be made, leave the main electronics assembly in the out position. Otherwise, swing the assembly inward and install the cabinet cover.

4.7.5 Overpressure Protection Adjustment

This adjustment is made with the main electronics assembly in the out position, as described in paragraph 4.7.4. Proceed as follows:

1. With the operating handle in the TEST or VENT position, set the ELECT. switch to the off position.
2. Remove the red high-voltage lead from the spectrometer tube and connect a 10-megohm $\frac{1}{2}$ watt resistor between the high-voltage lead and ground (TP4).

⚠ WARNING

The high-voltage lead has a potential of 2000 volts when the ELECT. switch is ON. Be sure the switch is off before making this connection. A quick voltmeter check is advisable.

3. When the resistor is properly connected, set the ELECT. switch to the ON position. Then flip the FIL. switch to the ON position to energize the spectrometer tube filament. The green FIL. indicator should light.
4. Observe the SPECTROMETER TUBE meter. It should read about 0.25 milliTorr or just above the green band.
5. Locate R58 on the main electronics assembly (9, Fig. 4-4) and adjust so as to just shut off the filament (FIL. indicator off) with a 0.25 milliTorr (green band threshold) indication on the SPECTROMETER TUBE meter.
6. If other adjustments are to be made, leave the main electronics assembly in the out position. Otherwise, swing the assembly inward and install the cabinet cover.

4.7.6 Display Amplifier Adjustment (Leak Rate)

There are two amplifiers associated with the spectrometer tube and the vertical leak-rate display: a preamplifier module in the spectrometer tube body and a 2-stage operational amplifier (U8, U10) on the main electronics assembly. If the second-stage amplifier needs rezeroing (because of preamplifier replacement), proceed as follows:

1. With the operating handle in the TEST or VENT position, set the ELECT. switch to the off position.
2. Set the RANGE switch to the leftmost position, then rotate the CAL. control fully clockwise.
3. Unplug the preamplifier connector (P/J310) and place a cliplead or other short across pins 7 and 8, thereby shorting input of U8 (Fig. 4-18).
4. Set the ELECT. switch to the ON position.
5. Locate R65 on the main electronics assembly (Fig. 4-4). Adjust R65 for a value as close as possible to zero (first bar segment) on the leak-rate display.
6. Set the ELECT. switch to the off position. Remove the cliplead and reconnect P310 to the preamplifier.
7. Set the ELECT. switch to the ON position and cycle the leak detector to TEST.
8. Adjust the ZERO control on the front panel approximately five turns from either end.
9. Re-zero the leak-rate display using the COARSE ZERO control. The pointer on this control should now lie between the "9 o'clock" and "4 o'clock" positions. If it does not, readjust R65.
10. If other adjustments are to be made, leave the main electronics assembly in the out position. Otherwise, swing the assembly inward and install the cabinet cover.

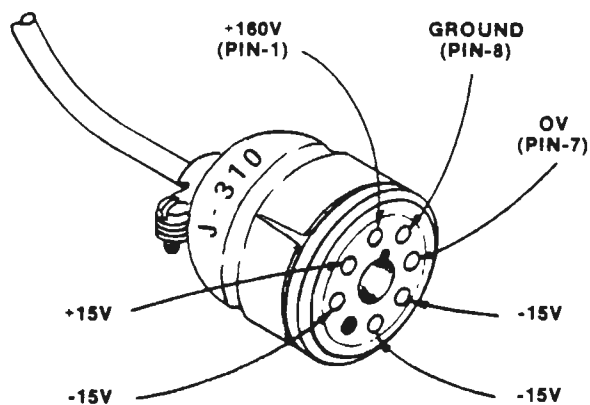

Fig. 4-18. Preamp Connector

4.7.7 Diffusion Pump Power Adjustment

This adjustment of diffusion pump minimum power may be required when testing for small leaks, if normal sensitivity cannot be attained (probably after cleaning and recharging the diffusion pump). This is despite full use of the CAL. control and the D.P. CONTROL, and a continuous test port pressure of 150 milliTorr or higher does not cause the spectrometer tube pressure indication to rise above the green band.

1. Check that the MAIN POWER and ELECT. switches are in the ON position, the operating handle is in the TEST position, and the diffusion pump has been turned on.
2. Install an ac voltmeter (on a scale above 120 volts) between test block terminal TB601, pin 41 and J416, pin 4 (Fig. 4-19).

⚠ WARNING

Exercise care when connecting the meter to the source of ac power. Use of long, sharp test probes is recommended because they must be inserted over wires.

3. Warm up the diffusion pump as usual (high heat), then turn the D.P. CONTROL fully clockwise to allow the instrument to stabilize (about 20 minutes).

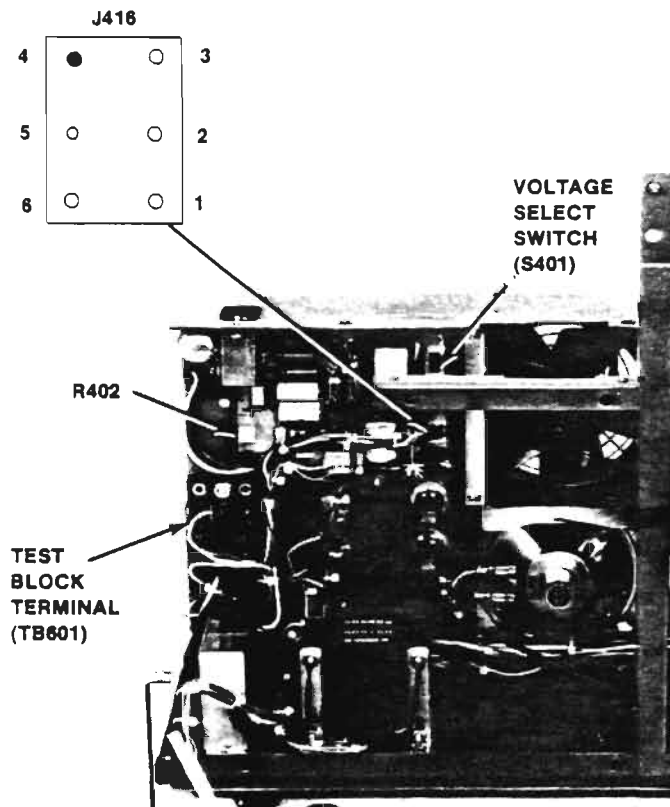

Fig. 4-19. Connections for Diffusion Pump Power Adjustment

4. Measure the Maximum Tolerable Test Pressure (MTTP), using a tuning leak or equivalent adjustable air inlet valve in the test port. Slowly open the valve until the SPECTROMETER TUBE pressure meter is at the top of the green band (about 0.2 milliTorr). Note the test port pressure reading.
5. If the MTTP is below 80 milliTorr, adjust potentiometer R402 (Fig. 4-19) to increase the voltage by 5 volts. (See step 7 for MTTP above 100 milliTorr and step 9 for MTTP between 80 and 100.)

NOTE

Turn R402 slowly and in small increments. Turn only enough to make the necessary change.

6. Let the instrument run at the new setting for 10 minutes, then go back to step 4 and continue.
7. If the MTTP is above 100 milliTorr, slowly readjust R402 to decrease the voltage by 5 volts.
8. Let the instrument run at the new setting for 10 minutes, then go back to step 4 and continue.
9. When the MTTP is between 80 and 100 milliTorr, the diffusion pump is performing correctly. At this setting, the sensitivity for one minor division should be 2×10^{-10} std cc/sec. If the sensitivity is less than 2×10^{-10} std cc/sec (e.g., 6 or 8×10^{-10} std cc/sec), refer to Section V, Troubleshooting.

4.7.8 Residual Background Check

Install an ac voltmeter (on a scale above 120 volts) between test block terminal TB601, pin 41 and J416, pin 4 (Fig. 4-19).

Once testing is complete and helium is no longer entering the leak detector through a leak, the vacuum system rapidly removes the remaining helium. However, a small residual amount is usually present, called background. Normally, this background is steady and can be cancelled by zeroing the leak-rate display. It is sometimes useful to measure background as an indication of a dirty system which needs cleaning or overhaul. Proceed as follows:

1. Verify that the leak detector is tuned and calibrated.
2. Install the test port plug or "valve-off" the inlet manifold.
3. Proceed with normal cycle to TEST status.
4. Place the RESIDUAL BACKGROUND switch in the CHECK position. (This makes the leak detector almost completely insensitive to all gases, including helium.)
5. Turn the RANGE switch to the leftmost position.
6. Adjust the ZERO control* until the leak-rate display indicates zero, then set the RESIDUAL BACKGROUND switch to the RUN position. The resulting reading is background.
7. Re-zero the leak-rate display before using the leak detector. At the time of shipment, background is about 5×10^{-9} cc/sec or less. If the background rises above 5×10^{-8} cc/sec, the vacuum system may be contaminated or it may have a leak. In this case, refer to Section V, Troubleshooting.

4.7.9 Circuit Board Replacement

If a problem is isolated to a PC board assembly, the assembly should be replaced in its entirety so that leak testing can continue without prolonged interruption. The assembly can then be fault isolated to the piece-part level, using the troubleshooting information in the 938-41 service manual (Varian Part No. 0981-6999-09-515).

There are four PC board assemblies: the main electronics assembly, the display board, the diffusion pump constant-power control, and the spectrometer tube high-voltage power supply board.

Main Electronics Assembly

To replace this assembly, proceed as follows:

1. Remove power from the leak detector and the mechanical pump.
2. Remove the test port plug (2, Fig. 4-2). Then remove the test port cap (3), O-ring (5), O-ring follower (4), and test port nut (6).
3. Remove the cover assembly (7, Fig. 4-2).
4. Remove the two screws (6, Fig. 4-4) and swing the main electronics assembly (3) outward on its hinges.
5. Disconnect the electrical plugs (P1, P2, P3, P4, P5) from the main electronics assembly.

*See note in paragraph 3.4.2 regarding the zero adjustment.

6. Remove the three screws on the right rear of the cabinet that secure the main electronics assembly hinges to the base cabinet. Then remove the assembly (with the hinges) from the cabinet.
7. Replace the main electronics assembly, reversing the above procedure. Be sure that the wiring harness folds properly and does not get caught in the access door.
8. Retune (and recalibrate) the leak detector, as described in paragraph 3.4.

Display Board

To replace this assembly, proceed as follows:

1. Remove power from the leak detector and the mechanical pump.
2. If desired, remove the leak detector from the cart (Fig. 4-1).
3. Remove the test port plug (2, Fig. 4-2). Then remove the test port cap (3), O-ring (5), O-ring follower (4), and test port nut (6).
4. Remove the cover assembly (7, Fig. 4-2).
5. Remove the operating handle.
6. Remove the two front screws (#10-32 x 2½" long) that hold the valve block in position.
7. Remove the two front mounting feet and the center screw (¼-20) from the brace. Then disconnect the electrical plug and remove the front panel and display board assembly.
8. After removing the RANGE and ZERO control knobs, remove the four nuts that secure the display board to the front panel. Then replace the display board.
9. Reverse the above procedure to reassemble the leak detector components.
10. Apply power to the leak detector and the mechanical pump. Then retune (and recalibrate) the leak detector, as described in paragraph 3.4.

Diffusion Pump Constant-Power Control

To replace this assembly, proceed as follows:

1. Perform steps 1 to 4 of the procedure for replacing the display board.
2. Disconnect the three electrical plugs (P406, P416, P426) from the diffusion pump constant-power control board.
3. Remove the four screws (9, Fig. 4-5) that secure the control board to the cabinet.
4. Replace the control board. Then reverse the above procedure to reassemble the leak detector components.
5. Apply power to the leak detector and the mechanical pump. Then retune (and recalibrate) the leak detector, as described in paragraph 3.4.

High-Voltage Power Supply Board

To replace this assembly, proceed as follows:

1. Perform steps 1 to 4 of the procedure for replacing the main electronics assembly.
2. Remove the two screws (4, Fig. 4-3) that secure the high-voltage enclosure (2, Fig. 4-4) to the cabinet back panel. Then swing the enclosure clockwise, as shown in Fig. 4-4.
3. Remove the two screws that secure the bottom plate to the enclosure (Fig. 8-4). Move the bottom plate out of the way.

4. If a faulty electrical part is observed, try to replace the part directly. Otherwise, it is necessary to unsolder all of the leads before the board can be removed from the enclosure and replaced.
5. Reverse the above procedure to reassemble the leak detector components.
6. Apply power to the leak detector and the mechanical pump. Then retune (and recalibrate) the leak detector, as described in paragraph 3.4.

4.8 LEAK DETECTOR SELF-TEST

Accuracy, reliability, and stability of any mass spectrometer leak detector depends upon the leak-free integrity of its own vacuum system. Inherent helium background and its effect on sensitivity demands elimination of all detectable leaks. If performance degrades during operation or after some part of the vacuum system is opened for service, a methodical leak check will eliminate the possibility of a leak as the cause.

4.8.1 General Suggestions

The following suggestions apply whether leak checking components, systems, or the leak detector itself:

1. When spraying suspected leak locations, always apply helium sparingly, starting at the highest points first, since helium rises. If drafts, such as from a cooling blower, exist in the area, apply helium downstream from source first, or deflect draft until leak checks are completed.
2. If vent grooves exist at flanges or other assembled seals, apply helium to these points (rather than a general spray) to obtain the most positive response, minimize use of helium, and save time in checking.
3. Locate and repair large leaks (paragraph 4.8.2) before attempting to locate extremely small leaks.
4. Limit search to a general area of the test piece by isolation methods. Bagging, masking, or shielding with tape, plastic film or duct seal (if applied properly) will shorten the time required to locate both large and small leaks.
5. Use only enough helium to reach the leaks. Do not flood the area.

4.8.2 Test Port Pressure Greater Than 500 Milli Torr

Large leaks that will prevent the test port pressure from going below 500 milli Torr may be located by spraying with helium and listening for a rise in the frequency or tone of the mechanical pump noise, as helium enters the pumps in large quantities. Also watch the response to helium on the thermocouple gauge which may read higher or lower in a helium enriched atmosphere; e.g., helium coming into the system through a rather large leak.

4.8.3 Test Port Pressure Less Than 300 Milli Torr

1. Place leak detector in TEST mode and spray helium at suspected leak areas, such as test port thermocouple connection and vent valve. Watch for response on LEAK RATE bar-graph display.
2. Place leak detector in VENT position and spray helium at suspected leak areas, such as diffusion pump flange and foreline, spectrometer tube connections, service valve, rough pump connections, and cam shaft seal. Watch for response on LEAK RATE bar-graph display.

SECTION V. TROUBLESHOOTING

Careful maintenance will ensure proper operation of your Varian 938-41 Porta-Test Leak Detector, but occasionally a problem will arise. The following table lists the symptoms with appropriate corrective measures by number. See Table 5-1 for the actual corrective measures.

First verify that the 938-41 is plugged into an appropriate AC power receptacle which is properly earth grounded (to water pipe). Verify that all plugs and connectors within the leak detector are firmly seated (spectrometer tube, cables, diffusion pumps, etc.).

Locate the symptom below and execute the associated corrective measure. If the symptom persists despite attempts to correct it, call your Varian service center for advice or service, as appropriate. Describe symptoms clearly to facilitate prompt solution.

Potentiometer adjustments that may be necessary when troubleshooting the leak detector, or after board replacement, are listed in Table 5-2.

Symptom	Corrective Measure No. (See Table 5-1)
SWITCHES	
1. MAIN POWER switch is ON; fan does not run, test port pressure indicator does not respond.	1, 2, 3
2. ELECT. switch is ON, but no action is observed in SPECTROMETER TUBE pressure meter.	4
PUMPS	
1. Mechanical pump emits gurgling sound after pumping for a full minute or longer.	5, 6, 7
2. Diffusion pump is not hot 20 minutes or more after being turned on.	3, 8
TEST PORT PRESSURE INDICATOR	
1. No display; MAIN POWER switch is ON and mechanical pump is operating.	2, 9, 10
2. Pressure drops slowly and/or does not reach normal transfer point.	11, 12, 13
3. Pressure does not rise to "ATM" when operating handle is turned to VENT.	14

FILAMENT INDICATOR

1. Will not light when FIL. power switch is flipped to ON. 15, 16
2. Will not stay lit when FIL. power switch is released. 17, 18, 19, 20, 21, 16
3. Stays lit when spectrometer tube pressure rises above green band. 17, 22
4. Stays lit when FIL. power switch is flipped to OFF. 23, 24
5. Suddenly goes out. 18, 20, 15, 21, 16

LEAK RATE DISPLAY

1. Low or no sensitivity to helium. (Operating handle is in TEST; display responds to ZERO adjustment.) 25, 26, 27, 28, 29, 30
2. Unusually high sensitivity to helium. 31, 26
3. High helium background. 32, 33, 34
4. Display insensitive to ZERO control. 10, 37, 35, 36, 38
5. Display remains below zero point (despite ZERO and COARSE ZERO adjustments). 10, 37, 38
6. Display reads full scale when it should not. 37, 39, 36
7. Display very unstable. 40, 41, 39, 36
8. Display fluctuates slightly. 40, 41, 39
9. Display drifts upscale. 40, 39, 41, 34
10. Leak rate indication does not agree between range scales. 42

AUDIBLE ALARM

1. No audible signal (LEAK RATE display indicating). 44, 45
2. Audio threshold cannot be set. 46, 47

SPECTROMETER TUBE PRESSURE METER (access door open)

1. Pointer does not drop into green band. 48, 49, 32, 33, 31, 50
2. Meter does not indicate. 51, 52, 53, 33, 10, 50
3. Meter fluctuates. 48, 33, 41
4. When pressure rises above green band, FIL. lamp remains lit. 17, 22
5. Pressure rises when operating handle is turned to START. 54, 55
6. Pressure rises above green band when operating handle is turned to TEST. 56, 55
7. Pressure rises above green band when operating handle is turned to VENT. 57

TUNING

- | | |
|---|--------------------|
| 1. Helium peak at or near 10 on ION tuning control. | 60 |
| 2. Low or no voltage at TP1, TP2, or TP3. | 58, 27, 59 |
| 3. No COARSE ZERO or ZERO control. | 10, 37, 35, 36, 38 |

Table 5-1. Corrective Measures

No.	Corrective Measures
1.	Check that blower is plugged in and operating.
2.	Check circuit breaker CB602.
3.	Check for shorted or overloaded power circuit and correct.
4.	Check that power switch and CB602 are ok. Check CB603. If it is off, disconnect P36 and P46 from main electronics assembly. Try again; if CB603 remains on, replace main electronics assembly. If CB603 remains off, check fan, diffusion pump control, and T603 for short circuits.
5.	Check for large leak in system. See paragraph 4.8.
6.	Check oil level in pump. Fill pump to level between two lines on sight glass.
7.	Check that all ports are plugged.
8.	Check for poor connection in wiring to diffusion pump heater or defective diffusion pump heater. Repair or replace as necessary.
9.	Thermocouple vacuum gauge defective.
10.	Check for faulty display; if necessary, replace display board.
11.	Roughing pump oil low or contaminated.
12.	Check for leak in roughing system or test port assembly. See paragraph 4.8.
13.	Check for defective mechanical pump or for a broken belt. Repair or replace as necessary.
14.	Defective vent valve.
15.	Check for faulty FIL. indicator; if necessary, replace display board.
16.	Check emission circuit.
17.	Check adjustment of overpressure set-point circuit (R58). See paragraph 4.7.5.
18.	Check for burned out filament. Switch to other filament. If both filaments are burned out, replace ion source (see paragraph 4.6.3).
19.	Check that EMIS. control is clockwise to at least mid-position.
20.	Check that spectrometer tube pressure is in green band.
21.	Check TP12 and TP13 for presence of between 2 and 4 volts, indicating that the filament is energized.
22.	Check for failure of overpressure set-point circuit.

No.

Corrective Measures

23. Check relay K2 (should be de-energized).
24. If K2 is energized, replace main electronics assembly.
25. Verify that the filament is on and emission is present (voltage between TP12 and TP13).
26. Try retuning leak detector; readjust calibration to match standard leak.
27. Check for a shorted ion source: While monitoring test point voltages per paragraph 4.7.3, unplug the ion source. If voltage changes, replace ion source.
28. Check for misalignment of ion source in spectrometer tube. See Fig. 4-15.
29. Replace ion source.
30. Standard leak void of helium (extremely rare). Remove leak, install port plug with human hair across O-ring to keep test port pressure high and utilize helium naturally present in the air.*
31. Diffusion pump control set too high; turn to lower dial number.
32. Check for leak in vacuum system. Refer to paragraph 4.8.
33. Dirty or defective cold cathode gauge. Check Fig. 4-17.
34. Standard leak does not shut off completely. Recheck with plug in test port.
35. Check for open circuit.
36. Check leak rate meter amplifier offset adjustment procedure. See paragraph 4.7.6.
37. Check that preamplifier is plugged in; check voltages at preamplifier plug (see Fig. 5-1). If problem persists, replace preamplifier. **CAUTION: TURN ELECTRONICS OFF BEFORE DISCONNECTING PRE-AMP PLUG.**
38. Check for defective ZERO or COARSE ZERO potentiometer.
39. Check for loose or poor connector at preamplifier and associated cabling. Try pressing lightly on each of these to see if better contact can be made.
40. Move RESIDUAL BACKGROUND switch to RUN position. If instability or drift decreases, trouble is contamination or leaking in the vacuum system. If instability or drift remains the same, trouble is in the electronics.
41. Check for leak in or near spectrometer tube.
42. Check ZERO setting of meter amplifier (see paragraph 4.7.6).
43. Check for open speaker.

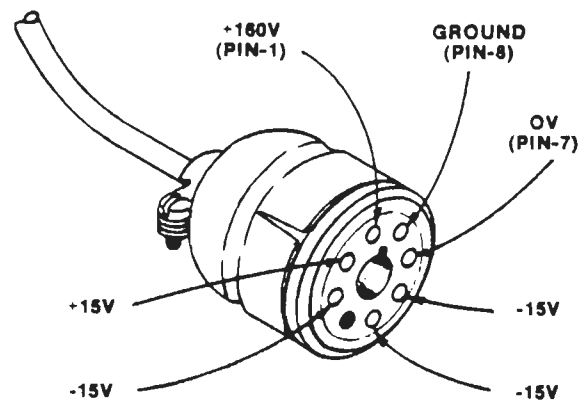

Fig. 5-1. Voltages at Pre-amp Plug

*Equivalent leak rate reading of 10^{-4} std cc/sec is produced at 100 millitorr.

No.	Corrective Measures
45.	Check loudspeaker and audio circuit. If necessary, replace loudspeaker or main electronics assembly.
46.	Check AUDIO control. If necessary, replace main electronics assembly.
47.	Replace main electronics assembly.
48.	Leak in service valve.
49.	Operating handle in START too long. Turn to TEST or VENT.
50.	Service valve in wrong position.
51.	Spectrometer tube is at atmospheric pressure. Recheck start-up procedure (paragraph 3.3).
52.	Cold cathode gauge discharge not started. Disconnect and reconnect red high voltage lead.
53.	Check for defective high voltage power supply. Check for approximately 2000 vdc with proper meter. (Red cable to ground.)
54.	Leak across test valve seat.
55.	Leak in operating valve shaft seal (valve block).
56.	Test port pressure is too high.
57.	Leak across rough valve seat.
58.	Check zeners in ion source power supply on main electronics assembly. If necessary, replace main electronics assembly.
59.	Check for defective potentiometer.
60.	Clean spectrometer tube (paragraph 4.6.2) with special emphasis on area at bottom of deflection chamber. (Contaminants here can pick up positive charges from heavy ion bombardment. These charges deflect the helium ion beam, requiring higher ion voltages and a higher number on the ion dial.)

Table 5-2. Adjustments

These adjustments are generally made after initial startup, with the MAIN POWER switch in the ON position:

1. In the thermocouple circuit, measure the voltage between J2, pin 9 (-) and test point TP8. Adjust R4 for a reading of +350 mvdc.
2. With the test port vented to the atmosphere, measure the voltage at J5, pin 14 (+) referenced to ground (-). Adjust R40 for a reading of +2.5 vdc. R16 may also have to be adjusted to achieve this reading.
3. With RANGE SELECT switch on number 8 and RANGE switch on least sensitive range, connect voltmeter between J4, pin 1 and ground. Adjust the COARSE ZERO control for 0.0 ± 5 mv.
4. With RANGE SELECT switch on number 7, measure the output of U8, pin 6. Adjust R65 for a reading of 0.0 ± 5 mv.

5. With RANGE SELECT switch on number 7, turn CAL potentiometer fully counterclockwise. Measure the voltage at U10, pin 6. Adjust R68 for 0.0 ± 5 mv.
6. Using a 12-megohm resistor to shut off the filament, adjust R58 counterclockwise for a lower trip pressure.

These adjustments are made with the diffusion pump turned on and pumped down:

1. With the RANGE SELECT switch on number 7, connect a voltmeter between J5, pin 13 and ground. Adjust the ZERO controls for a reading of -100 mv. Adjust R48 so that the second segment is just lit. Observe the voltage at J5-13 and adjust the fine ZERO control for a reading of -95 mv. The second segment should just go off. The threshold of on to off should be between -95 mv and -100 mv.
2. With the RANGE SELECT switch on number 8, adjust the ZERO controls for a reading of -4.00 volts at J5, pin 13. Adjust R13 for a leak rate of 8.0. Adjust the fine ZERO control for a reading of -3.98 volts. The 8 segment should just go off. The threshold of on to off is between -4.00 and -3.98 volts.
3. With the RANGE SELECT switch on number 8, make the following adjustment for the under-scale LED. Adjust the ZERO controls for a reading of +200 mv at J5, pin 13. Adjust R25 so that the under-scale LED is just lit. Adjust the fine ZERO control for a reading of +150 mv. The under-scale LED should just be off. The threshold of on to off is between +200 mv and +150 mv.
4. With the RANGE SELECT switch on number 8, make the following adjustment for the over-scale LED. Adjust the COARSE ZERO and fine ZERO controls for a reading of -5.00 volts. Adjust R16 so that the over-scale LED is just lit. Then adjust the fine ZERO control so that the over-scale LED is just off. The threshold of on to off should be between -5.00 volts (on) and -4.98 volts (off).
5. For the thermocouple gauge circuit, pump down the test port and move the operating handle to the TEST position. Adjust R16 so that the first segment on the left of the test port pressure bar graph is lit. Vent the test port and adjust R40 so that the last segment on the right is lit.

SECTION VI. THEORY OF OPERATION

6.1 GENERAL

This section describes the basic theory of operation of the vacuum diffusion pump and the spectrometer tube. Detailed theory of operation of the electronics is contained in the 938-41 service manual (Varian Part No. 0981-6999-09-515).

As shown in Fig. 6-1, the electronics subsystem includes the main electronics assembly, a display board, a diffusion-pump constant-power control board, and a high-voltage enclosure. The display board contains the RANGE switch and the bar graphs for the test port pressure and leak-rate displays. It also contains the LEDs and circuitry for the under-scale and over-scale indications, as well as the LED for the filament-on indication. The fine ZERO control on this board is connected across the COARSE ZERO control on the main electronics assembly; the COARSE ZERO control, in turn, is connected to the preamplifier in the spectrometer tube. The 3-second timer, which lights all segments of the bar-graph displays when main power is first applied, is also located on the display board. The diffusion pump control board provides a constant-power source to the diffusion pump heater when main power is applied. When the MAIN POWER switch is turned off, power for the diffusion pump heater and control is removed. The high-voltage enclosure contains the MAIN POWER and ELECT. switches, the SPECTROMETER TUBE pressure meter, and a printed-circuit board which provides the high-voltage for the spectrometer tube. All of the remaining circuitry is located on the main electronics assembly, with the exception of the circuit breakers, transformers, line filter, loudspeaker, and ac junction box, which are mounted on the cabinet.

6.2 DIFFUSION PUMP

The diffusion pump in the 938-41 Porta-Test Leak Detector is a baffled air-cooled pump (Fig. 6-2). The leak detector implements the diffusion pump in the "CONTRA-FLOW™ mode" by introducing helium from a leak into the pump foreline (outlet) rather than into the pump inlet as in conventional leak detectors. Helium, having a much lower maximum ratio* than other gases contained in air, diffuses backwards through the pump to reach the spectrometer tube where it is detected as a leak in the normal manner. The diffusion pump can thus be considered as a selective filter which allows only helium through to the spectrometer tube. Although the mechanical pump is also attached to the diffusion pump foreline and removes all inlet gases, including helium, there is no appreciable loss of sensitivity in the leak detector.

The maximum pressure ratio of helium may be 10 or 100, while for oxygen, nitrogen, and other gases contained in air, the ratios are normally in excess of 1 million. In the 938-41, the maximum pressure ratio of helium can be varied by changing the pumping action of the diffusion pump. This is accomplished by using a control to change the heat input. Changing the heat input not only changes the compression ratio, but also increases or decreases the sensitivity of the leak detector as required by the application.

*Diffusion pump pressure ratio is foreline (outlet) pressure divided by inlet pressure.

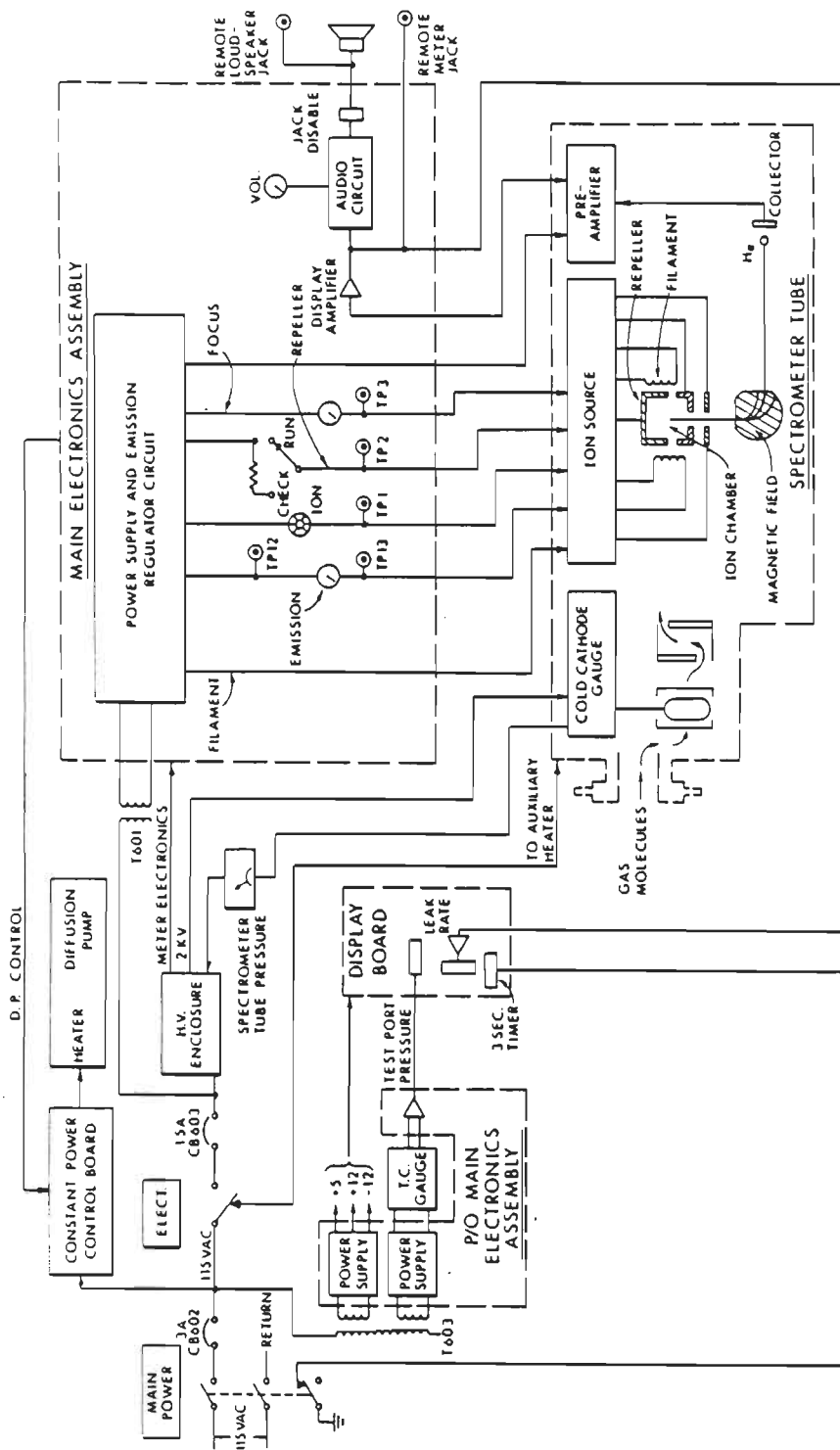

Fig. 6-1. Simplified Block Diagram of 938-41 Leak Detector

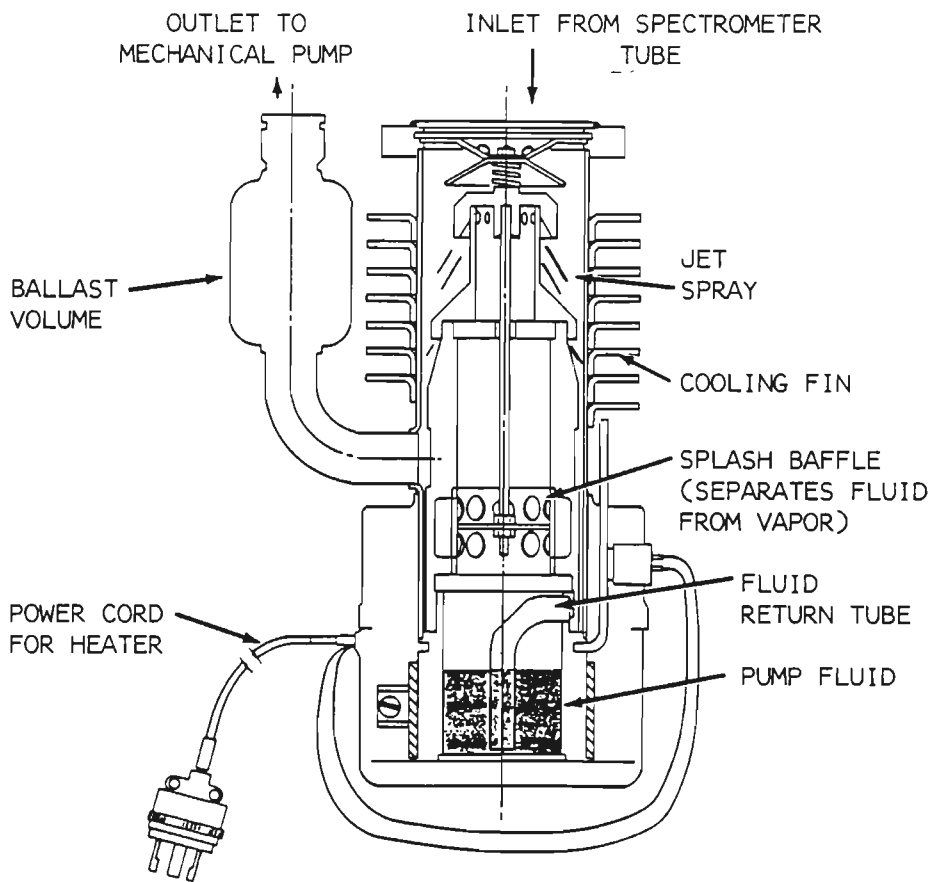

Fig. 6-2. Cutaway View of Vacuum Diffusion Pump

Basic components in the diffusion pump in the 938-41 are shown in Fig. 6-3 and include: a body assembly, with copper cooling fins; a jet assembly; a baffle; a heater assembly with associated thermostat and ac power cord; and a snap ring that secures the baffle and jet assembly in the opening at the top of the pump. Approximately 65 cc of pump fluid are contained in the boiler at the bottom of the pump. This pump fluid must be warmed by the heater assembly before the diffusion pump can be effective to evacuate the spectrometer tube to a pressure below 2×10^{-4} Torr.

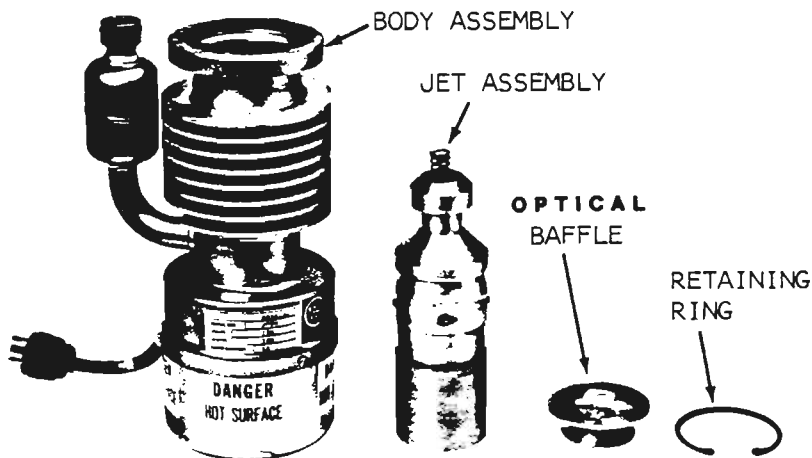

Fig. 6-3. Diffusion Pump With Jet Assembly Removed

During normal operation, when main power is applied, the electric heater heats the pump fluid in the boiler. When the temperature of the fluid rises to the boiling point, the vapor pressure above it increases. Vapor is forced up the center of the jet assembly and driven out through nozzles at each stage in the jet assembly. The result: supersonic, expanding streams of vapor molecules directed outward and downward across the space between the jets and the inner wall of the pump. These vapor streams hit the wall (which is fitted with cooling fins), the vapor condenses and runs back down the wall to the boiler reservoir where it is recirculated. Gas molecules, present at the inlet of the pump, are pushed downward into the pump by action of the vapor jets, creating a vacuum in the spectrometer tube. Helium atoms, entering at the foreline of the pump, tend to collide with the heavier downward gas atoms and molecules. However, many diffuse back through the jet assembly and work their way up to the spectrometer tube. These are the helium atoms that pass through the cold cathode gauge to the ion chamber in the spectrometer tube and are indicative of the extent of leakage in the test object. The larger the leak, the more helium atoms diffuse into the spectrometer tube. The smaller the leak, the less helium atoms diffuse into the spectrometer tube. The rate at which helium atoms diffuse into the spectrometer tube is proportional to the leak rate* into the test object and is read directly on the leak-rate bar graph.

It takes approximately 30 minutes for the pump to reach fully operating temperature. Once stabilized, it is better to leave the diffusion pump on, rather than shutting it off, especially if operation is to be resumed the next day. Conversely, when performing routine maintenance on the diffusion pump, enough time should be allowed for the boiler to cool down to a reasonable handling temperature after main power has been removed.

6.3 SPECTROMETER TUBE

6.3.1 Principle of Operation

An exploded view of the spectrometer tube is shown in Fig. 8-7. This tube is the heart of the 938-41 Porta-Test Leak Detector. Operating at less than 10^{-5} Torr, it identifies helium in the presence of other gases by ionization and magnetic separation. It produces an output current proportional to the amount of helium present at any time within the tube. This current is amplified and used to drive the vertical bar-graph display on the front panel of the instrument. This display indicates leak rate in cc/sec.

Internal electronic circuits operate the spectrometer tube and the leak-rate bar graph, and also provide an audible tone (if desired) that fluctuates with the leak rate. The vacuum system provides the necessary vacuum, 0.2 milliTorr or less. The valve system and roughing pump evacuate the object to be tested and properly sequence the testing operation.

The spectrometer tube is attached by means of a KF flange with an integral O-ring. Subassemblies include collector/preamplifier, a cold cathode vacuum gauge, an ion source, and an internal electric heater. The tube is surrounded by a magnetic field provided by two large pole pieces fastened to a block of Alnico V Magnet. Placing rotatable external eccentric magnetic pole pieces on each side of the ion source enclosure allows adjustment of the electron beam direction for maximum ionization and sensitivity.

*Leak rate can be expressed in terms of "std cc/sec" or "atm cc/sec". The first term is an abbreviated form of "cubic centimeters per second at standard temperature and pressure". The term "atm cc/sec" describes the same volume flow rate, but defines it at whatever atmospheric pressure and ambient temperature prevail at the time. In leak detection, atm cc/sec is considered to be virtually interchangeable with std cc/sec, except at locations substantially above sea level.

The block of Alnico V is mounted permanently between two large rectangular, soft iron plates. Inserts in these plates direct the magnetic flux into two pole pieces that define the magnetic field which separates the helium from other ions. Made of nickel-plated mild steel, the two pieces are identical, keyed for proper insertion, and O-ring sealed to the spectrometer tube to facilitate service. Other inserts provide fields for the cold cathode vacuum gauge fan for the ion source.

Helium reaching the spectrometer tube first passes through the cold cathode gauge (Fig. 6-4). The cold cathode gauge monitors the vacuum (absolute pressure) within the tube and triggers a protective system which shuts the filament off if the pressure exceeds 0.2 milli Torr.* The gauge consists of two pole pieces, a liner that forms the cathode, and a nichrome loop mounted on a single ceramic insulator for an anode. The assembly seals in place with an O-ring. The magnetic field is provided by the common magnet. Helium passes through the cold cathode gauge and baffle to the ion source.

The ion source emits electrons when one of its two filaments is heated. As these electrons collide with the helium atoms, positive helium ions are generated. Other gas atoms and molecules present in the ion chamber are also ionized, creating additional positive ions in the chamber. All of the positive ions are forced out through a slit in the ion chamber by the repelling action of a high-voltage electrode. These streams of ions are then passed through a magnetic field in the spectrometer tube, where they are deflected in proportion to their mass-to-charge ratio.

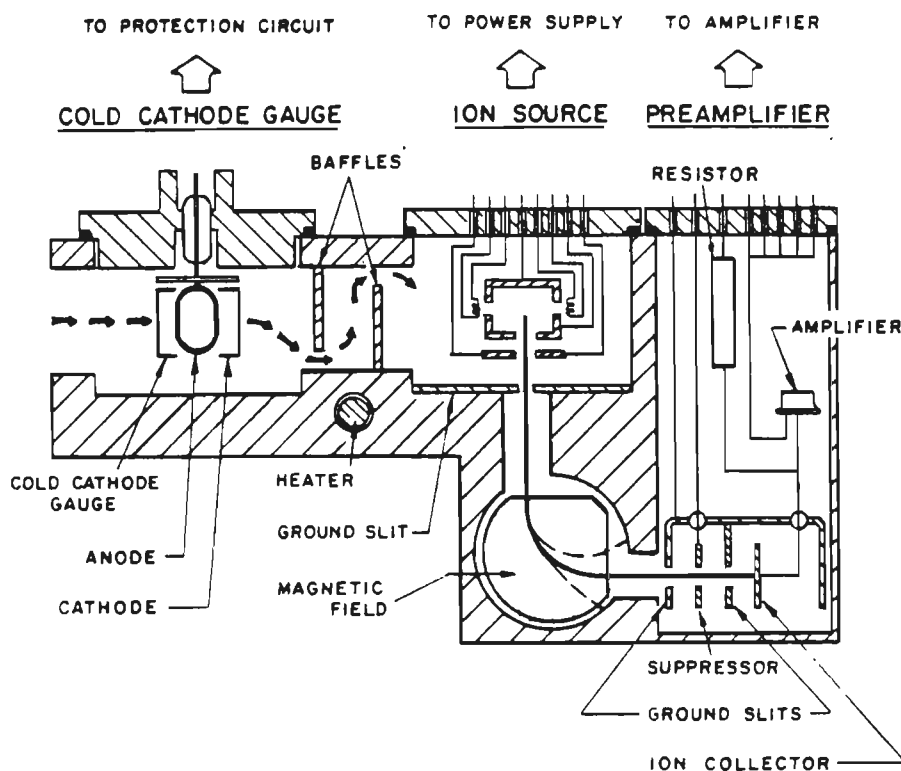

Fig. 6-4. Cutaway View of Spectrometer Tube

*This is for tungsten filaments. Higher pressure (up to 1 milli Torr) is possible, but filament life may be reduced.

The spectrometer tube is designed and adjusted so that hydrogen ions are deflected approximately 135°, helium ions exactly 90°, and all heavier species less than 90°. Consequently, only helium ions are allowed to pass through right-angle ground-potential slits and arrive at the ion collector in the preamplifier section of the spectrometer tube. The ion collector current varies with the number of helium ions and is proportional to the partial pressure of the helium in the tube. The solid-state preamplifier amplifies the electrical output of the spectrometer tube. This amplified output is further amplified and used to drive the leak-rate bar graph (calibrated in cc/sec) and an audio circuit.

The ion source is a one-piece expendable unit, consisting of the following parts:

- a. Two permanently-aligned tungsten or iridium filaments (one used as a spare) that provide a source of electrons.
- b. An ionization chamber into which electrons are "beamed" in order to strike gas atoms or molecules to create positive ions.
- c. A repeller electrode that repels these positive ions, forcing them out through a slit in the ion chamber.
- d. Two focus plates that direct the ion beam toward a slit in a ground-potential plate.

The parts are welded to eight rods that extend through individual glass seals in a round flange to form the male portion of a standard octal connector. A special clamp and O-ring are used to seal the assembly into the spectrometer tube. This construction permits easy servicing of the tube. The spare filament allows leak testing to continue after one filament burns out until it is convenient to discard the entire source assembly. In addition, no cleaning or disassembly of the source is necessary. It is inexpensively and easily replaced as a unit. All parts of the unit are prealigned, and the unit itself is keyed to the spectrometer tube so that no special skill is required to replace it.

The preamplifier assembly contains an ion collector assembly and a preamplifier stage with a temperature compensation circuit. The ion collector assembly includes ground-potential electrodes to guide the beam of helium ions, a suppressor electrode to exclude any other ions, and an ion collector electrode to translate helium ions into an electrical signal. The preamplifier stage includes a solid-state temperature-compensated, computer-optimized operational amplifier and a feedback resistor. Having the preamplifier in vacuum protects the electrical signal from external interference and stabilizes the leak-rate display. Like the ion source, the entire assembly is mounted as a unit on eight rods that extend through individual glass seals in a round flange to form the male portion of the preamplifier section connector.

The preamplifier assembly is factory prealigned and is of all-welded construction. It is sealed in place with a clamp and O-ring. Removal and replacement require no special skill.

Electrical connections are made to the ion source and preamplifier modules by means of removable, female octal plugs. A flexible high-voltage cable with a center wire brings power to the connector at the base of the cold cathode vacuum gauge. Removal of any one of these three modules from the spectrometer tube body is accomplished by simply removing the screws from the rectangular clamps at the base of each module (after properly isolating and venting the spectrometer tube) and then gently sliding the module out of the tube body. Special alignment instructions must be followed when reinstalling the modules.

One of the two filaments in the ion source is sufficient to keep the spectrometer tube at normal elevated temperature during the leak test. When power for the electronics is removed, a separate 15-watt cartridge heater in the spectrometer tube is automatically energized to keep the tube at the same elevated temperature. Maintaining a continuous elevated temperature in the spectrometer tube helps prevent condensation of contaminants in the tube.

6.3.2 Explanation of Tuning Controls

As will be seen in Fig. 6-5, electrons “boiling” out of the hot filament are driven through the slit into the ion chamber. Inside the chamber, they create positive ions by bombarding neutral molecules. Positive ions of many different gases are ejected through a slit in the bottom of the ion chamber. They are then accelerated and passed through a ground potential slit. After this they travel at constant velocity through a magnetic field which is at right angles to their path. This causes the ions to follow different paths according to their mass, heavier ions being deflected less and lighter ions more.

Helium ions are deflected 90° so that they alone enter the collector (where they cause an electrical current to flow in proportion to the number of ions collected per second).

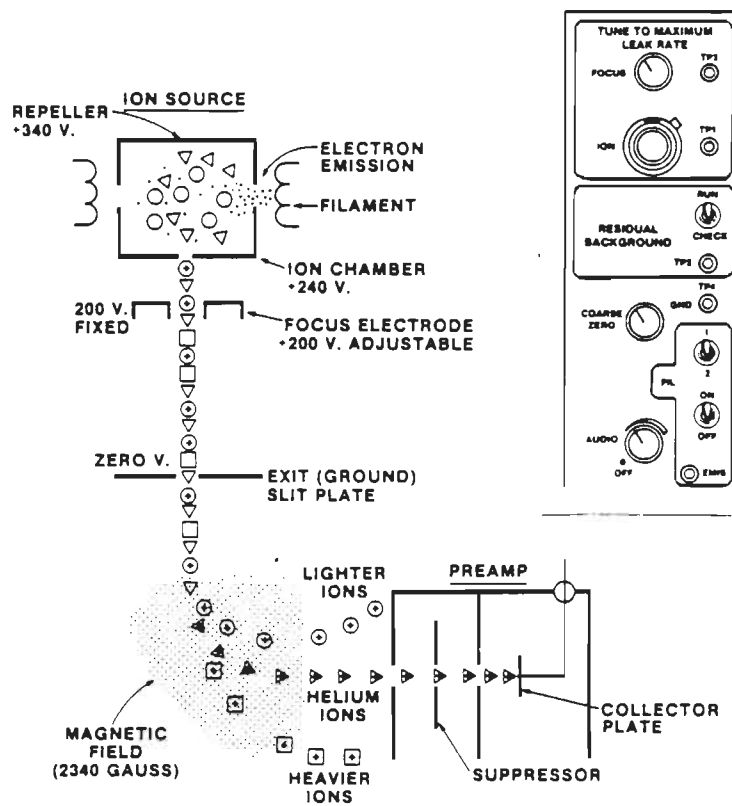

Fig. 6-5. Mass Separation

This is what happens when the 938-41 is properly tuned to helium. To understand the tuning procedure, it is helpful to understand how the formation, acceleration and separation of ions is actually brought about. It is done with DC voltages which affect ions in much the same way as gravity affects a ball in a pinball machine — with an important difference. Gravity exhibits attraction only, whereas DC voltages can attract **or** repel ions. Some of these voltages are fixed, while others are adjustable to permit external control.

The table below shows the adjustments available to the user and the typical range of DC voltages in these adjustments:

<u>Parameter</u>	<u>Adjustment Control</u>	<u>Adjustment Range</u>
1. ELECTRONS ENTERING ION CHAMBER		
a. Quantity per unit time	EMIS. Control	
b. Direction	Black knobs on the spectrometer tube	
2. IONS LEAVING ION CHAMBER		
a. Energy	ION Control	160-330 VDC
b. Quantity per unit time	Repeller Control*	330 or 430 VDC
c. Direction	FOCUS Control	250-310 VDC

The following pages explain the various controls by individual diagrams similar to the one in Fig. 6-5. Voltages shown are typical.

*Repeller control is achieved with the RESIDUAL BACKGROUND switch (see paragraph 4.7.3).

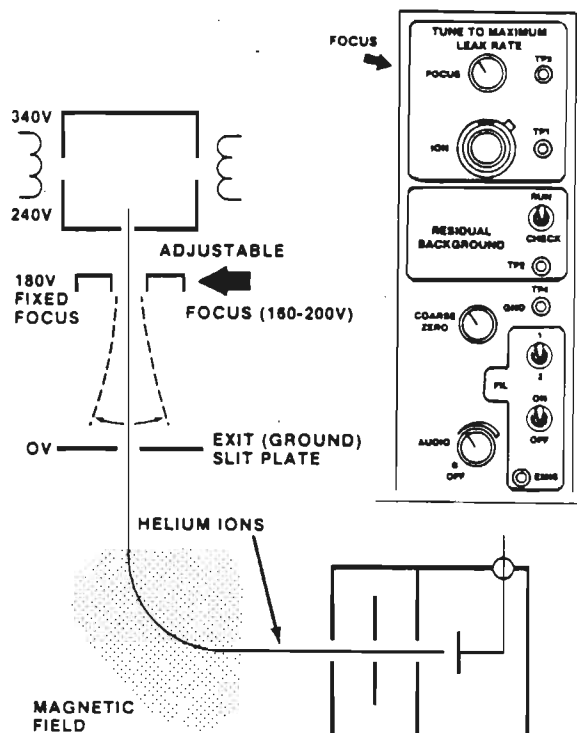

Fig. 6-6. Focus Control

FOCUS CONTROL

The focus control determines the direction taken by the beam of ions emerging from the ion chamber. In the correct position, the ions pass through the exit slit into the magnetic field.

The focus control is the most critical tuning adjustment. Unless all of the ions pass through the exit slit, no indication will appear on the LEAK RATE display regardless of the other adjustments.

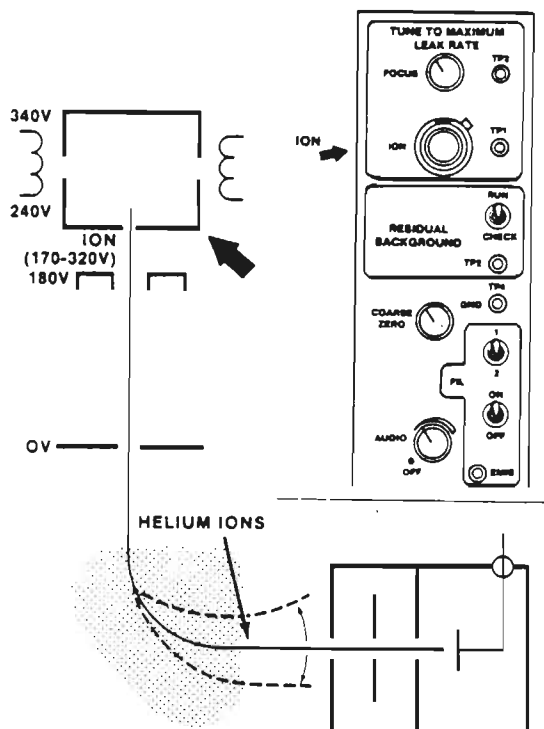

Fig. 6-7. Ion Control

ION CONTROL

By adjusting voltage between ion chamber and ground slit plate, the ion control determines the rate of acceleration of the ions. In the correct position, helium ions enter the collector because they have entered the magnetic field at the right velocity to be deflected 90°.

It should be noted that ions other than helium (mass 4) can also be collected. By deliberately adjusting ion voltage to 4/6 of the value for helium, one can tune the leak detector to mass 6 (probably a doubly ionized carbon molecule). Similarly, at 4/3 of the helium voltage, one can tune to mass 3 (most likely hydrogen).

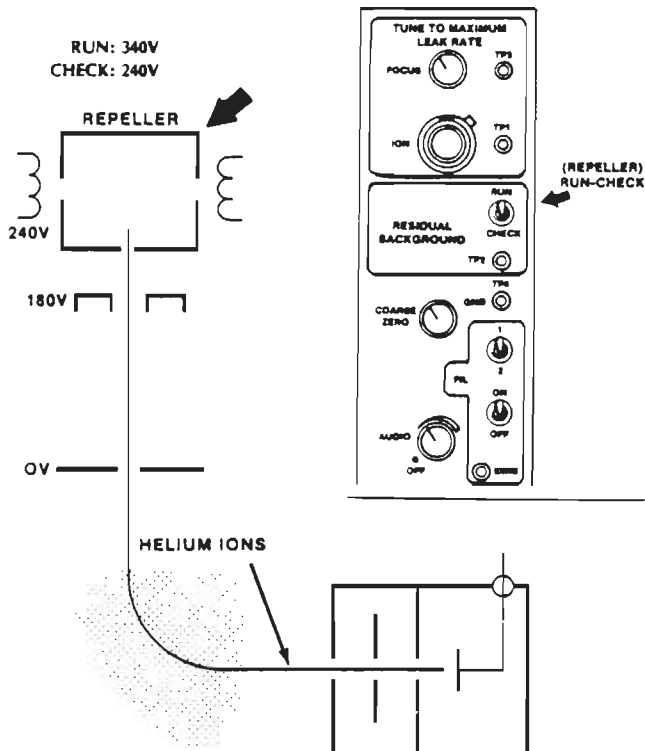

Fig. 6-8. Repeller Control

REPELLER CONTROL (RESIDUAL BACKGROUND)

Causes the ejection of ions from the ion chamber. Normally it is in the RUN position. This puts an extra 100 volts positive DC potential on the repeller electrode and repels the positive ions out through the exit slit at the bottom of the ion chamber.

In the CHECK position, the repeller control removes the extra 100 volts and restores the repeller electrode to exactly the same DC voltage as the ion chamber. Virtually no ions emerge. This is useful for determining residual helium (background) in the leak detector (see paragraph 4.7.8)

EMISSION CONTROL

Controls leak detector sensitivity by controlling the rate of electron emission from the filament. In general, when the emission is increased, more ions are formed, hence a greater leak rate reading results.

Sometimes, when the emission is increased still further, a "peak" is reached, beyond which the rate of ion formation is reduced.

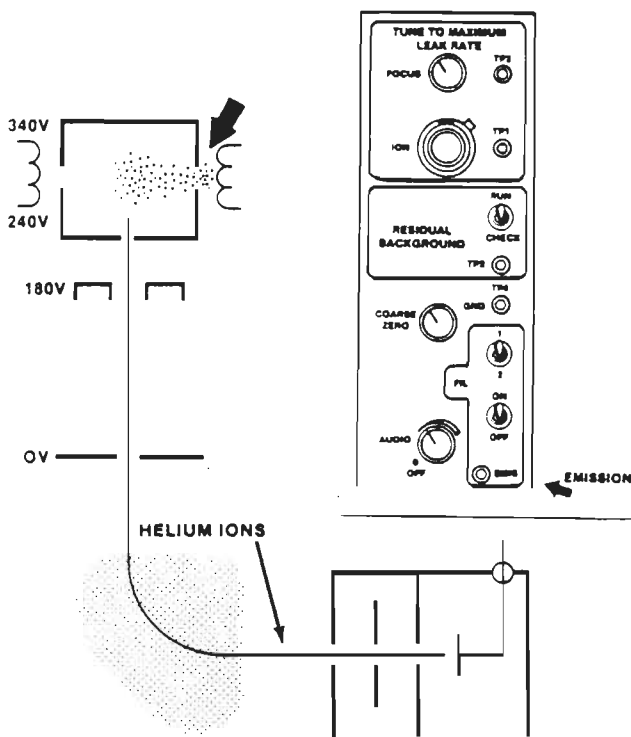

Fig. 6-9. Emission Control

ION SOURCE MAGNET CONTROL

The knobs on the spectrometer tube turn through 360° and maximize the production of helium ions by magnetically optimizing the electron flow into the ionization chamber.

SECTION VII. FUNDAMENTALS OF LEAK DETECTION

7.1 LEAK TESTING — WHY IS IT NEEDED?

Even with today's complex technology it is, for all practical purposes, impossible to manufacture a sealed enclosure or system that can be guaranteed leak proof without first being tested. Through the use of modern leak testing techniques, as implemented by the Varian 938-41 Porta-Test Leak Detector, leak rates in the 10^{-10} std cc/sec range can be reliably detected. The discussion that follows provides a brief summary of specific information pertinent to the overall subject of leak detection. First, the reasons for leak testing can be grouped as follows.

1. Hermetic Enclosures (or parts thereof)

These are tested to prevent entrance of contaminants or loss of fluid that would affect performance of the enclosed unit. Examples: electronic devices, integrated circuits, sealed relays, motors, ring pull-tab can ends, and multipin feedthroughs.

2. Hermetic Systems

These are tested to prevent loss of fluid or gas within. Examples: hydraulic systems and refrigeration systems.

3. Evacuated Enclosures (or parts thereof)

These are tested to prevent too-rapid deterioration of vacuum with age. Examples: electron tubes, TV picture tubes, bellows sensing elements, full-panel-opening can ends, etc.

4. Vacuum Systems

These are tested to minimize inleakage and allow attainment of better vacuum or higher gas removal ability at any given vacuum (absolute pressure).

7.2 TERMINOLOGY

The following terminology has application throughout this manual:

1. Flow

std cc/sec — one cubic centimeter of gas per second at a pressure of one standard atmosphere (760 torr at 0°C).

atm cc/sec — one cubic centimeter of gas per second at ambient atmospheric pressure and temperature (used interchangeably with "std cc/sec" because the difference is insignificant for leak testing purposes).

2. Rate-of-Rise (Vacuum Systems)

This is defined as the rate of increase of absolute pressure per unit time, with the vacuum pump isolated from the system and is the sum of actual inleakage and internal outgassing. Rate of rise is usually expressed in torr or microns (millitorr) per hour.

3. Conversions

1 std cc/sec	= 0.76 torr-liter/sec	} for practical purposes, equal
1 torr-liter sec	= 1.3 std cc/sec	
1 std cc/sec	= 9.7×10^4 micron cubic feet per hour or practically 10^5 micron CFH (μ CFH)	
1 μ CFH	= practically 10^{-5} std cc/sec	
1 std cc/sec	= 0.1 Pascal cubic meters/sec	

4. Numerical notation-exponential system

Most leak rates of commercial significance are very small fractions of a std cc/sec. Therefore minus powers of ten are used as a convenient system of numerical shorthand:

1×10^{-1}	=	$1 \times 1/10$	=	.1
1×10^{-2}	=	$1 \times 1/10 \times 1/10$	=	.01
5×10^{-3}	=	$5 \times 1/10 \times 1/10 \times 1/10$	=	.005
1×10^{-3}	=	$1 \times 1/10 \times 1/10 \times 1/10$	=	.001
1×10^{-6}	=	$1 \times 1/10 \times 1/10 \times 1/10 \times 1/10 \times 1/10 \times 1/10$	=	.000001

7.2.1 FACTS ABOUT LEAK RATES

1. Visualizing Leaks in Everyday Terms

10^{-5} std cc/sec: approximately 1 cc/day
 10^{-7} std cc/sec: approximately 3 cc/year

2. Audible or Visual Detection by Observer

- Bubbles rising in water: 10^{-4} std cc/sec or larger
- Audible Leaks: 10^{-1} std cc/sec or larger

3. Sizes of Leaks in Man-Made Joints

Studies indicate that almost all leaks at joints are about 5×10^{-7} std cc/sec (about 1 cc/month) or larger. This is true of ceramic-to-metal, plastic-to-metal seals, welded, soldered and brazed joints. Some long-path leaks may be slightly smaller. Diffusion of helium through glass may be as high as 10^{-8} std cc/sec per square centimeter of surface area.

4. Variation in Leak Sizes

Leaks unintentionally "built-in" at joints during manufacture may vary from hour to hour and day to day. Breathing on a 10^{-6} std cc/sec leak provides enough moisture to close it temporarily, perhaps for several days. Atmospheric particles can close a leak of this size. Never depend on an "accidentally made" leak to remain constant. Manufacturing standard leaks for calibration purposes requires special techniques.

7.3 VARIOUS METHODS OF TESTING FOR LEAKS

There are many methods of testing for leaks in enclosures — either systems or containers. The more commonly used methods along with the range of accuracy provided are listed below:

1. Water Immersion (Air Bubble Observation)

Probably the oldest method, water immersion is good to approximately 10^{-3} std cc/sec, and can be more sensitive if internal pressure is increased or vacuum is created above water pressure. This method is limited because of difficulty in differentiating between leakage bubbles and surface desorption bubbles. It is used to test industrial items such as valves, hydraulic components, castings, automotive and air conditioning components because of its low cost.

2. Dye Penetrant

A special dye, applied to one side of a surface suspected to contain a leak, seeps through the leak and appears on the other side. This method can take an hour or more for a 10^{-4} std cc/sec leak to show up. This test is inexpensive but destructive in some applications, as well as slow and messy.

3. Ultrasonic

This method is good to approximately 10^{-3} std cc/sec. This method tests for ultrasonic sounds coming from a gas leak and is used for testing of high pressure lines.

Halogen (sensitive to halogen elements or compounds, especially refrigerant gases)

This method is good to approximately 10^{-5} std cc/sec in most current applications, but extendable to 10^{-9} std cc/sec under some limited situations. It is critically dependent on operator judgement if leaks are below 10^{-5} std cc/sec and requires constant flow of fresh air in the test area because of the tendency of trace gas to "hang" in the area. The detector used in this method is sensitive to a variety of gases from external sources such as cigarette smoke and solvent fumes.

5. Radioisotope

This method is useful only for testing hermetically sealed cavities. It has approximately same range as the helium method but it involves an expensive installation (from four to ten times the cost of a helium installation depending on degree of isolation of radiation required.) It also requires a radiation safety officer.

6. Helium Method

This method is good to 10^{-11} * std cc/sec, and is capable of finding leaks of any larger size. This method is useful for testing hermetic seals, vacuum enclosures, and vacuum systems, and is the most versatile of industrial and laboratory leak detection testing methods.

7.4 HELIUM MASS SPECTROMETER LEAK DETECTION (MSLD)

1. Helium as an Ideal Tracer Gas

Helium is an excellent trace gas because it is the lightest of the inert gases and readily penetrates small leaks. In addition, its presence in the atmosphere is minute (5PPM or 4 millitorr absolute). Helium is easily detected by a simple mass spectrometer. Also, helium is readily available at reasonable cost, and is completely non-toxic and non-reactive. The basic principles of the helium MSLD technique are discussed below.

2. Principles of Mass Spectrometry

A mass spectrometer sorts gases by their molecular weights (mass number) to determine the quantity of each gas present. With the helium MSLD, the point of interest is primarily in helium (although such a device can be adjusted to indicate hydrogen). The mass spectrometer tube is relatively simple. The principle is to ionize the gases in vacuum, accelerate the various ions through a fixed voltage, and then separate the ions by passing them through a magnetic field. A slit, properly placed, allows only helium ions to pass through and be collected. The resulting current is amplified and a meter indicates the presence and amount of helium.

3. Application as a Leak Detector

A mass spectrometer leak detector consists of a spectrometer tube, the electronics to operate it and interpret its output and a high vacuum system to maintain proper vacuum. In addition, means are provided for connecting a test object, and a "rough vacuum" pump and a system of valves is provided to evacuate the test object for connection to the spectrometer tube; or, if it is a sealed object containing helium, to evacuate a chamber containing the test object.

*Using Varian 936-65 or other equivalent system.

4. The Reason for Vacuum

It should be noted that the purpose of the vacuum system is to support operation of the spectrometer tube. Helium molecules entering through a leak individually reach the spectrometer tube in a few milliseconds. Helium molecules, as well as molecules of other gases, are continuously removed by the vacuum system diffusion pump. If helium is continuously applied to a leak, the concentration in the spectrometer tube will rise sharply at first, then it will reach equilibrium when it is being pumped out at the same rate as it is entering. When helium is completely removed from the leak, the input will drop to zero while the residual helium is pumped out of the system. Thus, a leak is indicated by a rise in output signal of the spectrometer tube.

5. Spectrometer Tube — What It Does, in brief

In the spectrometer tube, gas molecules are ionized (given a positive electrical charge) by bombarding them with electrons from a hot tungsten filament. Ions, thus formed, are accelerated into a magnetic field where the mass 4 (helium) ions are deflected 90° (see Figure 7-1). Only helium ions reach the collector. Heavier ions (mass 6 and up) are deflected too little to be collected. Lighter ions (masses 3 and 2) are deflected too much to be collected.

An extremely stable electrometer provides an electron current to the collector which measures the current produced by the collection of helium ions. This current is presented on the leak rate meter. Since this current is directly proportional to the number of helium ions striking the collector per unit time, the leak rate meter indicates the concentration of helium in the vacuum system at any time. Any helium entering the system causes an increased concentration of helium within the spectrometer tube and therefore an increased deflection of the leak rate meter. In addition to the electrometer, the electronics also provides suitable voltages to operate the spectrometer tube and controls and instrumentation for the vacuum system.

Test pieces are generally "rough" pumped (or, if pressurized, the chamber in which they are to be tested is "rough" pumped) by a separate mechanical vacuum pump before they are connected to the spectrometer tube. This prevents overloading the vacuum pumping system.

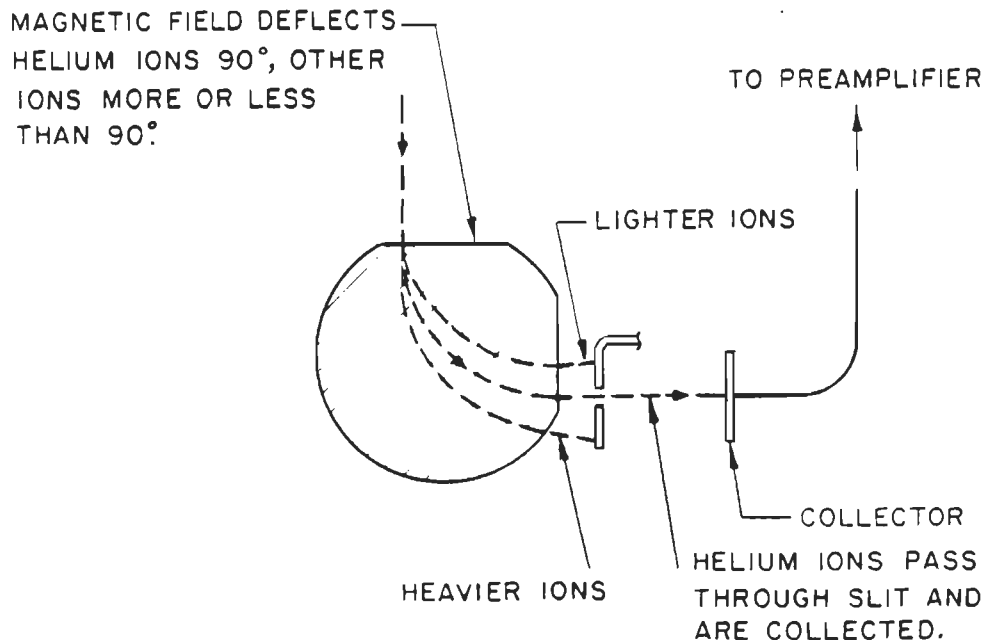

Figure 7-1. Magnetic Separation Principle

SECTION VIII

PARTS LIST

This section includes lists of replacement parts keyed to photographs and drawings. The Varian numbers of all parts are listed, with the exception of O-rings, which are available only in kit form, and items available in hardware stores.

ASSOCIATED WITH FRONT AND REAR VIEWS (Figs. 8-1, 8-2)

Item	Description	Varian Ordering Number
1	Handle Assembly	0981-K6143-301
2	Cover Assembly	0981-K9536-301
3	Screws for Cover and Operating Handle #10-32x $\frac{3}{8}$ " lg. Pan. Hd. Phil. s/s	0981-6144-20-462
4	Door Latch	0981-6413-23-069
5	Range Knob $\frac{1}{4}$ SHAFT, 90 D.D. EHC EH71-2GG2S	0981-6602-51-095
6	Zero Knob $\frac{1}{4}$ " " 500 D.D. EHC EH71-0N2S	0981-6602-51-325
7	Display Board	0981-K9519-301
8	Spacers (Display Board)	0981-6991-01-200
9	Operating Valve Handle	0981-K6134-301
10	Port Nut	0981-83488-001
11	Cap Assembly	0981-82847-301
12	Ring Follower	0981-82848-001
13	O-ring, Parker 2-216, Buna-N	*
14	Port Screen	0981-87626-302
15	Port Plug	0981-83489-001
16	Screws #10-32x2 $\frac{1}{2}$ " Long Pan Head Phillips Nickel Plated Mild Steel (4 REQUIRED)	0981-6144-12
17	Valve Block Assembly	0981-K9529-301
18	Remote Meter Jack	0981-6480-73-094
19	Remote Speaker Jack	0981-6480-73-087
20	Circuit Breaker, 115V, 3A (CB602)	0981-6431-09-013
21	Circuit Breaker, 115V, 0.5A (CB603)	0981-6431-09-009
22	Circuit Breaker, 230V, 1.5A	0981-6431-09-014
23	Fan (115V)	0981-6613-00-047
24	Fan (230V)	0981-6613-00-056

*Furnished in O-ring Kit, 0981-K7641-801

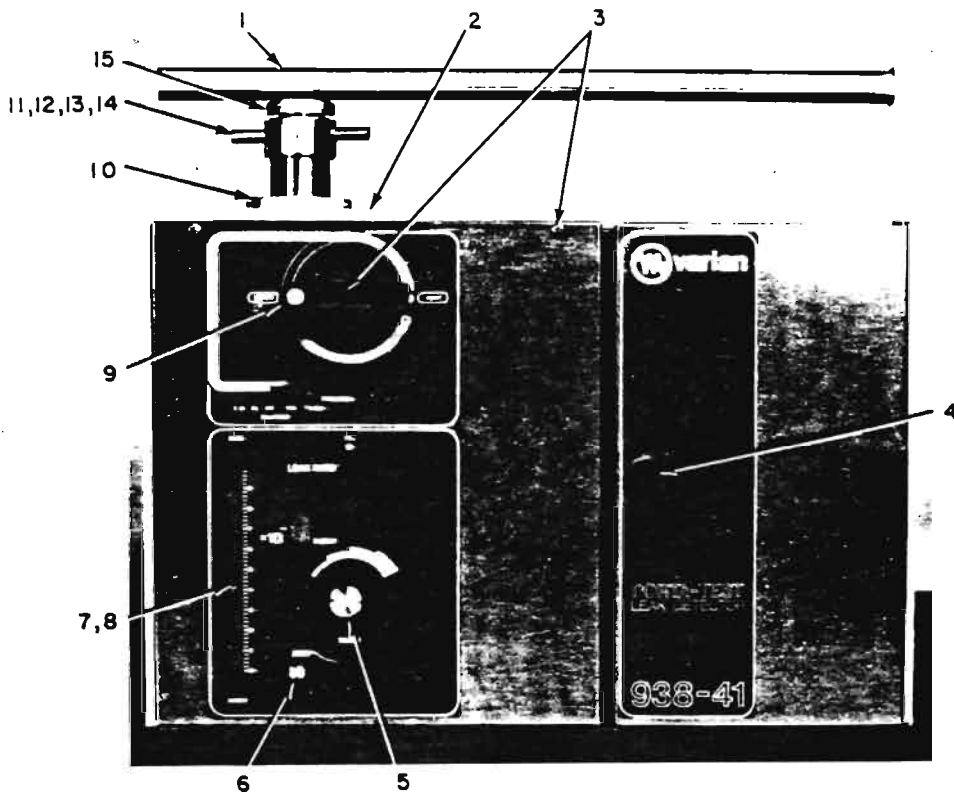

Fig. 8-1. 938-41 Leak Detector, Front View

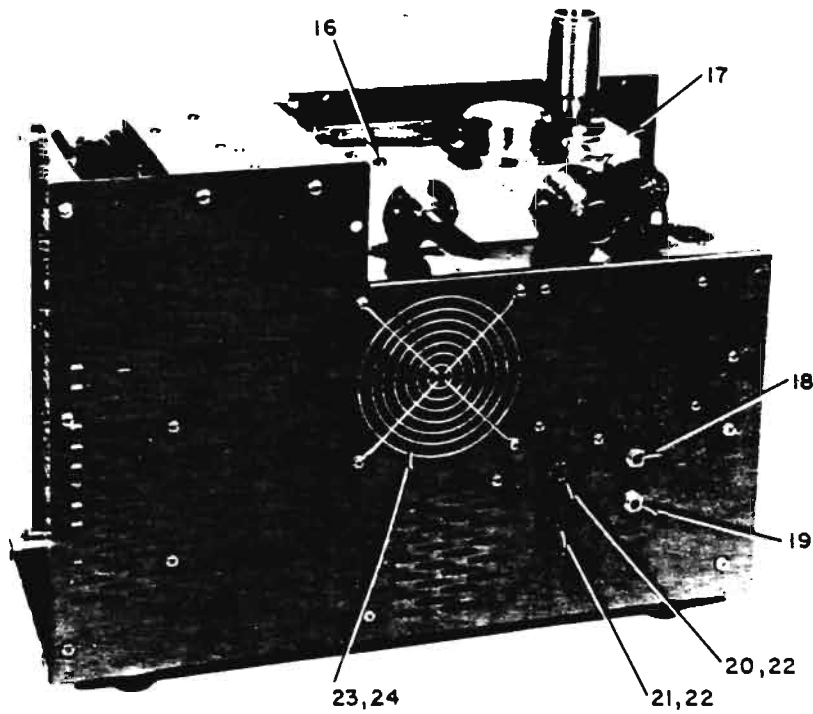

Fig. 8-2. 938-41 Leak Detector, Rear View (Cover Removed)

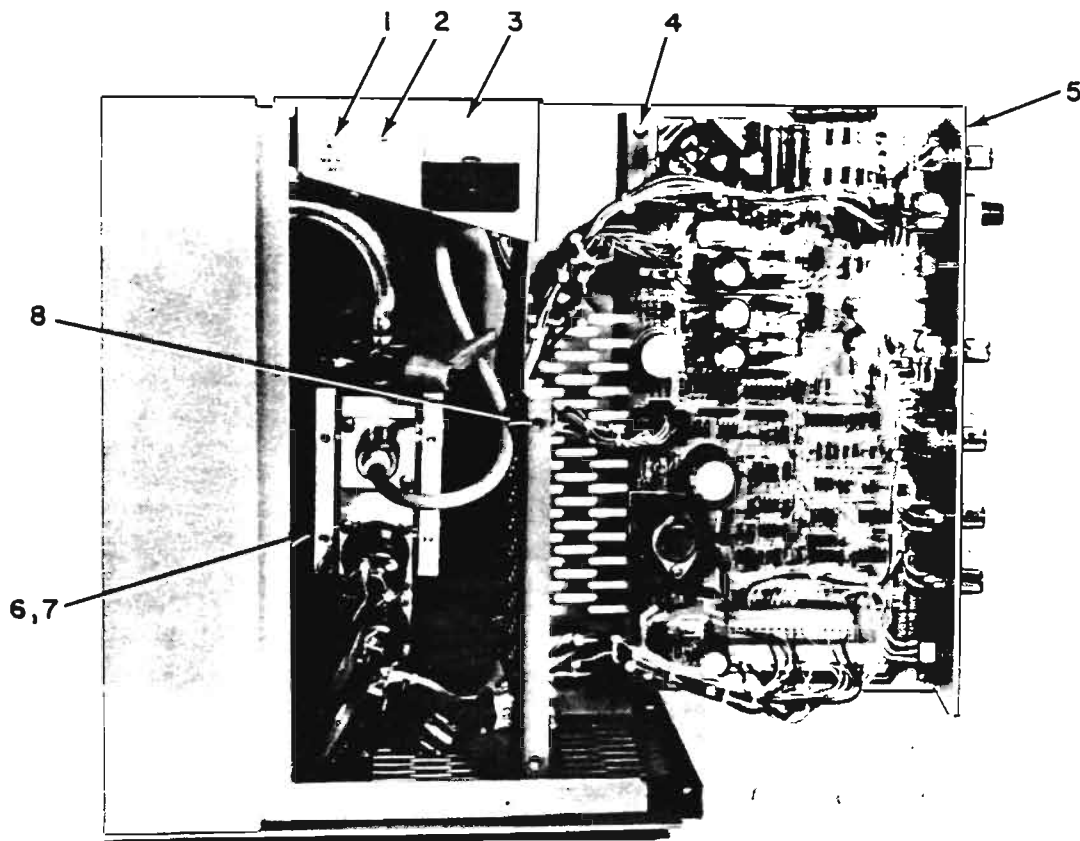

Fig. 8-3. Electronics Swung Open

ELECTRONICS SWUNG OPEN (Fig. 8-3)

Item	Description	Varian Ordering Number
1	Main Power Switch (S602)	0981-6421-02-049
2	Electronics Switch (S603)	0981-6421-02-036
3	Spectrometer Tube Pressure Meter (M603)	0981-K9546-001
4	Hinge for Main Electronics Assembly	0981-6990-06-255
5	Main Electronics Assembly	0981-K9518-301
6	Spectrometer Tube Assembly (115V)	0981-K6356-301
7	Spectrometer Tube Assembly (230V)	0981-K6356-302
8	Screw, #6-32x½ lg., Phillips Pan Hd.	0981-6144-20-236

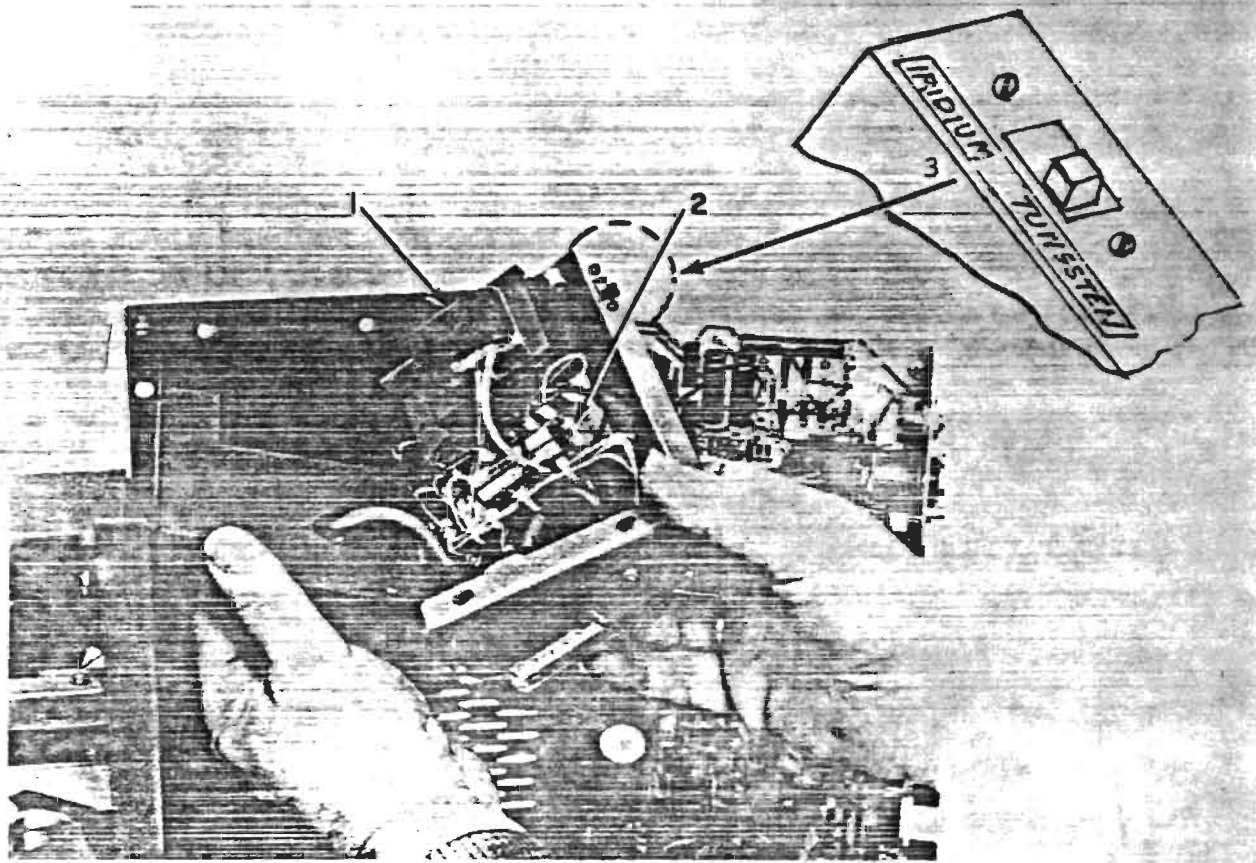
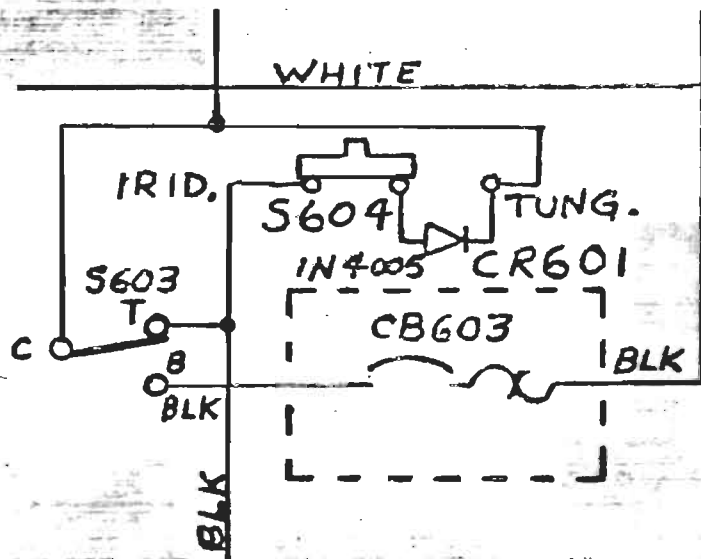

Fig. 8-4. High-Voltage Enclosure

HIGH-VOLTAGE ENCLOSURE (Fig. 8-4)

Item	Description	Varian Ordering Number
1	High-Voltage Transformer	0981-6581-00-244
2	High-Voltage Circuit Card Assembly	0981-K3053-301
3	Spec tube heater select switch assy (S 604)	0981-L5193301



See Fig. 9-1
for complete
schematic.

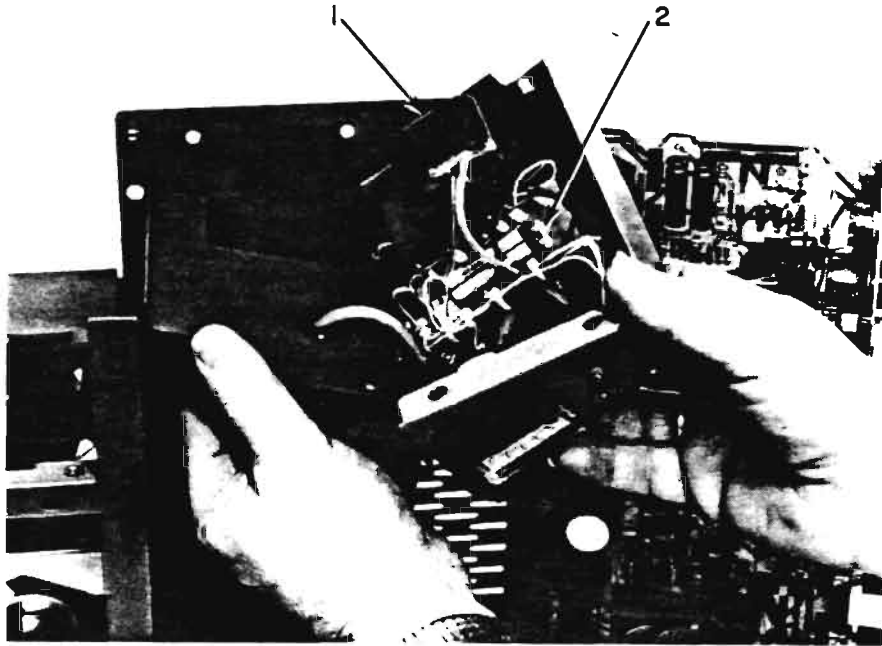

Fig. 8-4. High-Voltage Enclosure

HIGH-VOLTAGE ENCLOSURE (Fig. 8-4)

Item	Description	Varian Ordering Number
1	High-Voltage Transformer	0981-6581-00-244
2	High-Voltage Circuit Card Assembly	0981-K3053-301

1.04.00

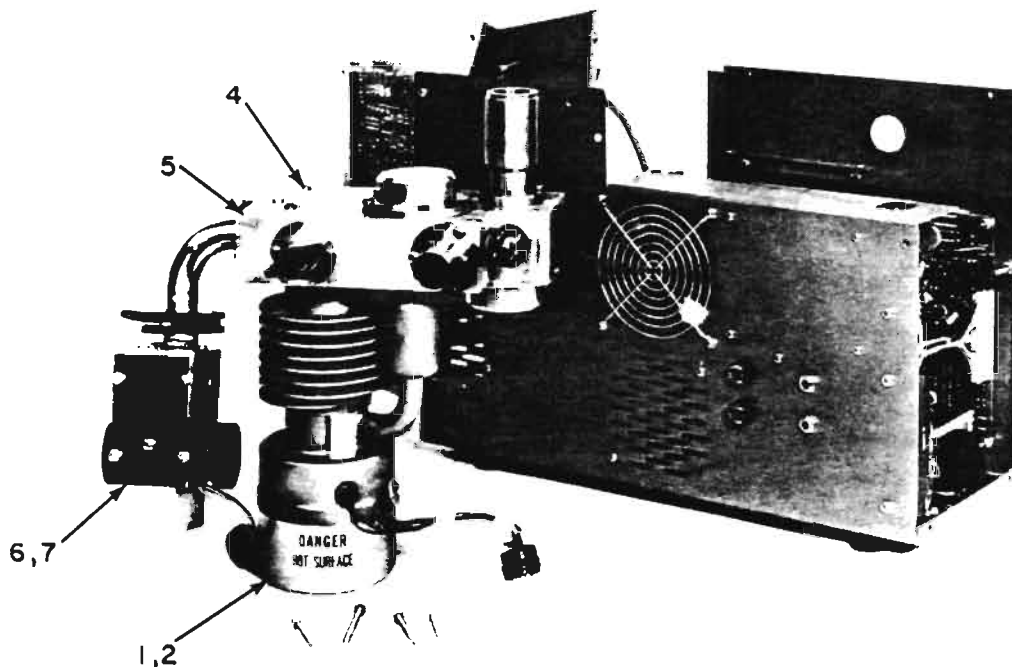

Fig. 8-5. Diffusion Pump Removed

DIFFUSION PUMP REMOVED (Fig. 8-5)

Item	Description	Varian Ordering Number
1	Diffusion Pump Assembly (115V)	0981-K9561-301
2	Diffusion Pump Assembly (230V)	0981-K9561-302
3	Santovac 5 Diffusion Pump Oil 65cc Bottle (not shown)	0981-6954-05-002
4	Screw, #10-32x2" lg., Phillips Pan Hd. MILD STL, NI PLTD, 3 REQ	0981-6144-20-478
5	Valve Block Assembly	0981-K9529-301
6	Spectrometer Tube Assembly (115V)	0981-K6356-301
7	Spectrometer Tube Assembly (230V)	0981-K6356-302

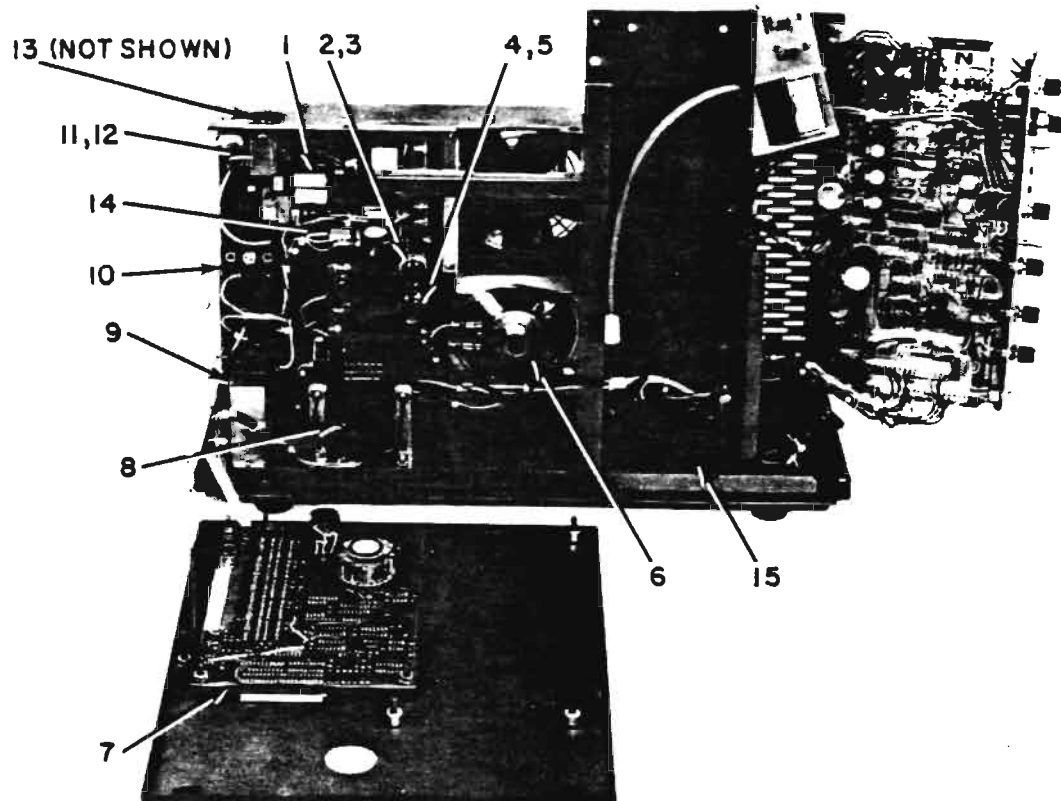

Fig. 8-6. Electrical Power Control

ELECTRICAL POWER CONTROL (Fig. 8-6)

Item	Description	Varian Ordering Number
1	Constant Power D.P. Control Board	0981-K7373-301
2	Circuit Breaker, 115V, 3A (CB602)	0981-6431-09-013
3	Circuit Breaker, 230V, 1.5A (CB602)	0981-6431-09-014
4	Circuit Breaker, 115V, 0.5A (CB603)	0981-6431-09-009
5	Circuit Breaker, 230V, 1.5A (CB603)	0981-6431-09-014
6	Loudspeaker, 4-inch (LSI)	0981-6700-09-910
7	Display Board	0981-K9519-301
8	Power Transformer (T601)	0981-K9555-301
9	Control Transformer (T603)	0981-K9552-301
10	115/230V Junction Block (TB601)	0981-K6058-001
11	Line Filter and Wiring (115V)	0981-K9549-301
12	Line Filter and Wiring (230V)	0981-K9549-302
13	Power Cord (115V)	0981-6564-59-166
14	AC Harness	0981-K9557-301
15	Signal Harness	0981-K9558-301

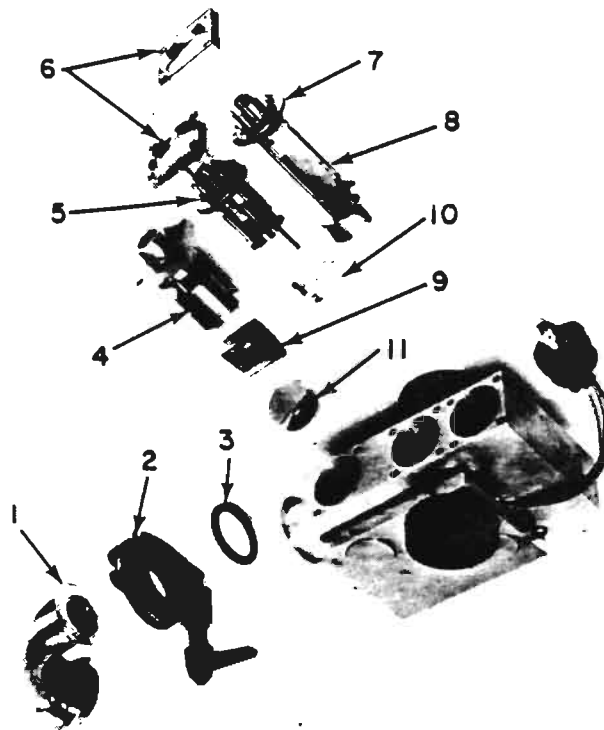

Fig. 8-7. Spectrometer Tube Assembly

SPECTROMETER TUBE ASSEMBLY (Fig. 8-7)
Includes Magnet Assembly Shown on Next Page)

Item	Description	Varian Ordering Number
1	Spectrometer Tube Manifold	0981-K9531-301
2	"KF" Clamp	0981-6354-80-025
3	O-ring, Parker 2-320, Buna-N	*
4	Cold Cathode Gauge (see Figure 8-9)	0981-82849-301
5	Ion Source	0981-82850-301
6	Flange Cap	0981-82852-001
7	O-ring, Parker 2-025, Buna-N (3)	*
8	Pre-amplifier	0981-K3333-301
9	Cathode Liner	0981-82849-008
10	Ground Plate	0981-K3088-001
11	Baffle	0981-83834-301

Screws (not shown) #8-32x $\frac{1}{2}$ " long, fillister head s/s 10 req'd.

0981-6132-20-158

*Furnished in O-ring Kit, 0981-K7641-801

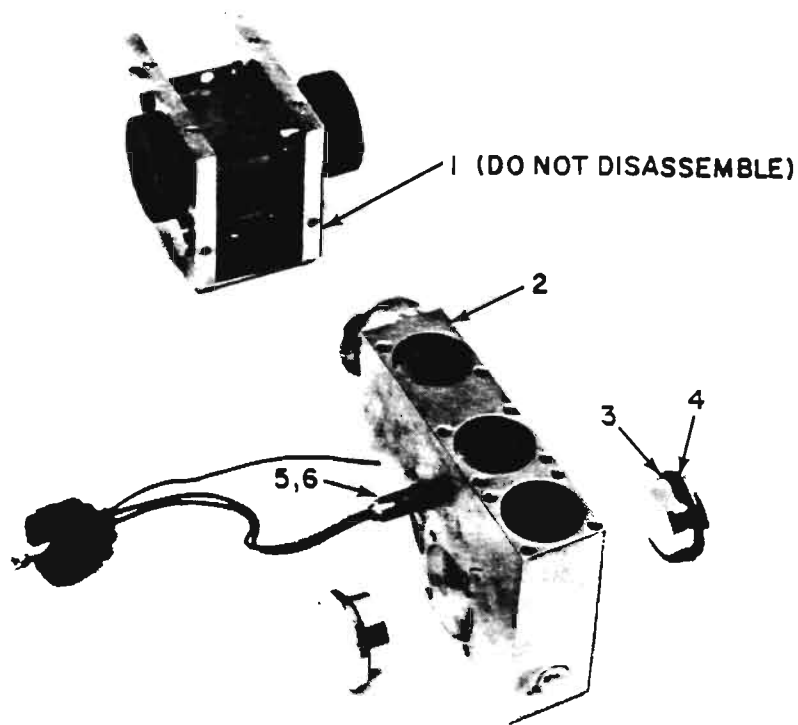

Fig. 8-8. Spectrometer Tube and Magnet Assembly

SPECTROMETER TUBE AND MAGNET ASSEMBLY (Fig. 8-8)

Item	Description	Varian Ordering Number
1	Magnet Assembly	0981-K3023-301
2	Spectrometer Tube Body	0981-K6355-301
3	O-ring, Parker 2-025, Buna-N (2)	*
4	Deflection Pole Piece	0981-K3093-001
5	Heater, 115 Volts	0981-K3057-301
6	Heater, 230 Volts	0981-K3057-302
	Screws (not shown) #8-32x $\frac{1}{4}$ " long, Pan Hd. s/s, 11 required	0981-6148-90-320

*Furnished in O-ring Kit, 0981-K7641-801

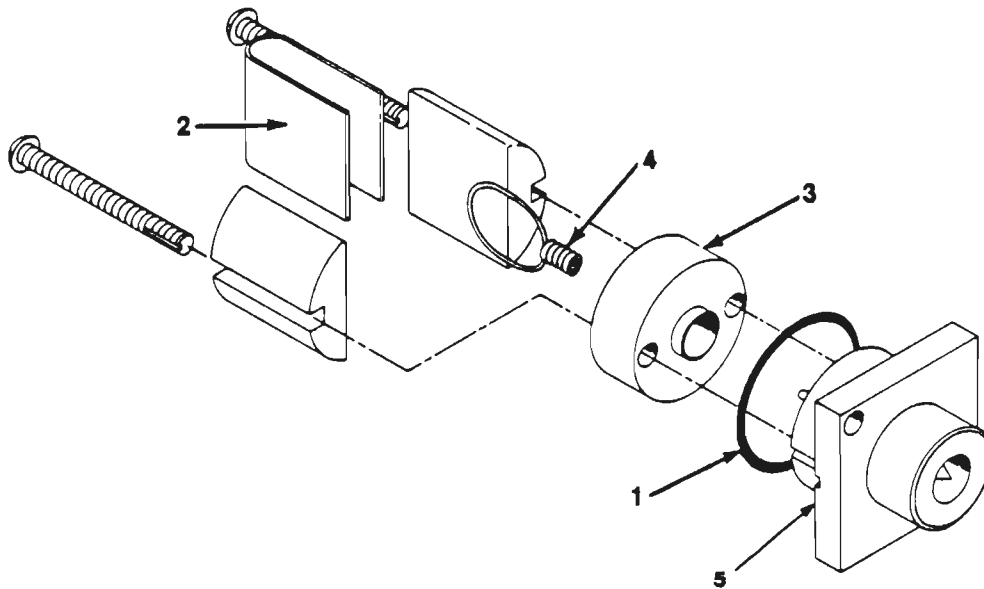

Fig. 8-9. Cold Cathode Gauge

COLD CATHODE GAUGE (Fig. 8-9)

Item	Description	Varian Ordering Number
1	O-ring, Parker No. 2-025, Buna-N	*
2	Cathode Liner	0981-82849-008
3	Spacer	0981-K9093-001
4	Anode	0981-82849-006
5	HEADER W/ FEED THRU	0981-82849-001

*Furnished in O-ring Kit, 0981-K7641-801

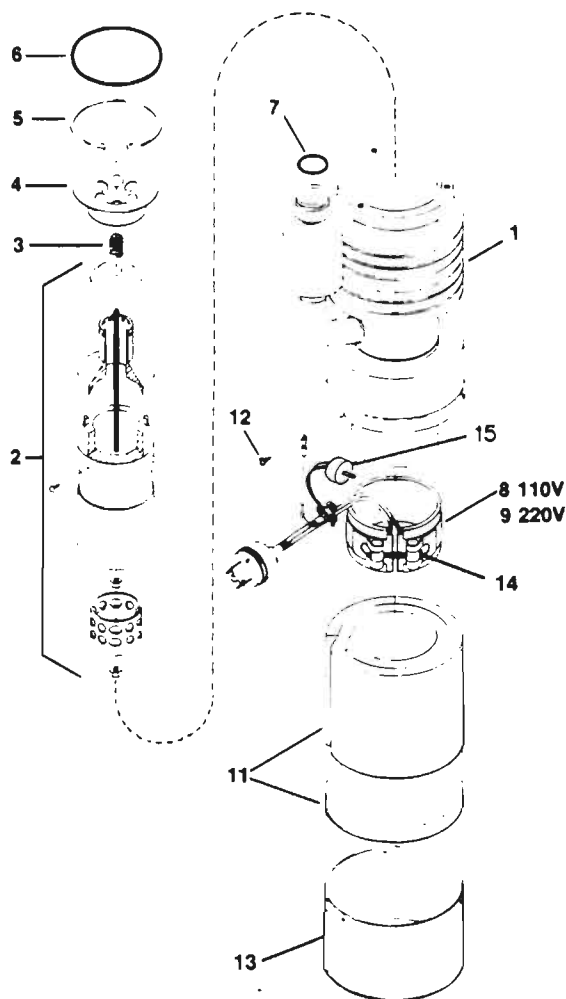

Fig. 8-10. Diffusion Pump

DIFFUSION PUMP (Fig. 8-10)

Item	Description	Varian Ordering Number
1	Diffusion Pump (complete)	0981-K9561-301
2	Jet Assy	0981-K6105-301
3	Jet Hold Down Spring	0981-6602-85-303
4	Baffle Assy	0981-K6109-301
5	Retaining Ring	0981-6999-92-231
6	O-ring Parker 2-231 Buna-N	*
7	O-ring Parker 2-210 Buna-N	*
8	Heater Assy, (115V)	0981-K9564-301
9	Heater Assy, (230V)	0981-K9564-302
10	Santovac 5 Diffusion Pump Oil 65cc bottle (not shown)	0981-6954-05-002
11	Insulation	0981-6700-99-915
12	#6-32x $\frac{3}{8}$ " lg. Type A Sheet Metal Screw	0981-6153-20-114
13	Reflector	0981-K6128-001
14	Screw (PART OF HEATER)	
15	Thermostat	0981-6475-06-278

*Furnished with O-ring Kit, 0981-K7641-801

VALVE BLOCK ASSEMBLY (Fig. 8-11)

Item	Description	Variation Ordering Number
1	Valve Block	0981-K9530-301
2	Cam Shaft	0981-K6047-001
3	Bearing, Fafnir #538	0981-6601-10-001
4	Retaining Ring	0981-6999-92-062
5	O-ring, Parker 2-110 Buna-N	*
6	Detent Plate	0981-K6048-001
7	Nut, Jam 3/8-24	0981-6172-20-058
8	Ball Plunger	0981-6700-36-140
9	Valve Seat	0981-K6049-001
10	Back Up Ring	0981-K3037-001
11	O-ring, Parker 2-218 Buna-N	*
12	Spring Assy	0981-K6081-301
13	Valve Cap	0981-K6082-001
14	O-ring, Parker 2-228 Buna-N	*
15	Screw, #10-32x3/8 lg. Pan Hd. Phil. s/s	0981-6144-20-462
16	Service Valve Shaft	0981-K6083-001
17	Bonnet, Service Valve	0981-K6086-001
18	Spacer, Long	0981-K6085-001
19	Spacer, Short	0981-K6084-001
20	O-ring, Parker 2-210 Buna-N	*
21	Knob	0981-6602-51-631
22	Vent Valve Shaft	0981-K6045-001
23	Bonnet, Vent Valve	0981-K6046-001
24	Spring	0981-6602-85-291
25	O-ring, Parker 2-011 Buna-N	*
26	Inlet Manifold	0981-K6088-301
27	Roughing Manifold	***
28	Spec. Tube Manifold	0981-K9531-301
29	O-ring, Parker 2-215 Buna-N	*
30	Screw, 4-40x1/4 lg. Fil. Hd. Phil. s/s	0981-6143-20-132
31	531 T.C. Gauge SPECIAL	0981-K9988-301
32	Special Washer	0981-K7119-001
33	Lock Washer, Spring #4 s/s	0981-6182-20-014
34	Apiezon L Grease**	5000-6954-00-004

*Furnished in O-ring Kit, 0981-K7641-801

**Furnished with Spare Parts Kit, 0981-K7642-801

***Roughing manifold stub for basic unit 0981-K6090-301

***Roughing manifold stub for cart model 0981-K9933-301

***Optional roughing manifold stub and KF clamp assembly 0981-K9535-301

***Optional roughing manifold stub with 360° rotating elbow 0981-K9533-301

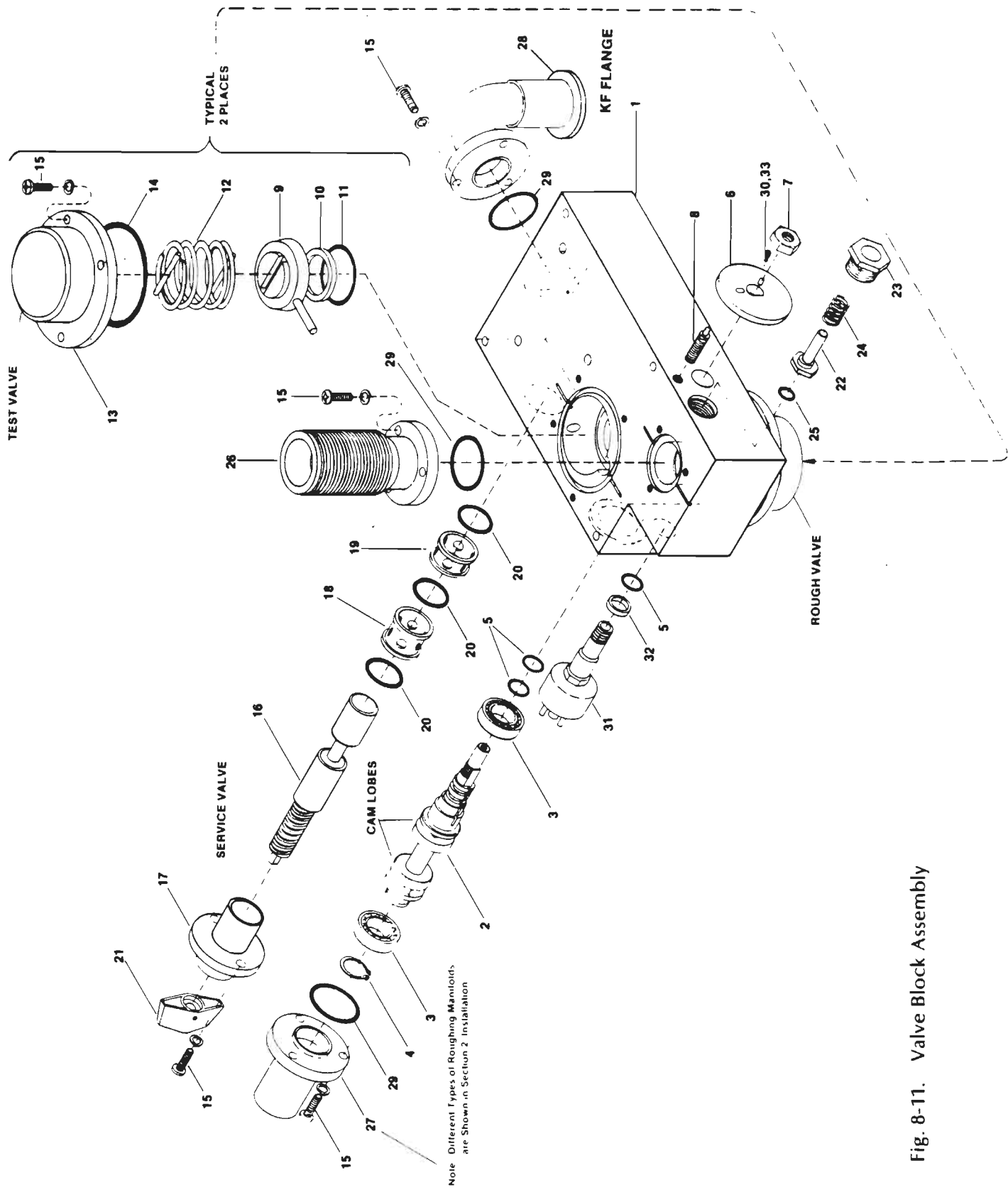

Fig. 8-11. Valve Block Assembly

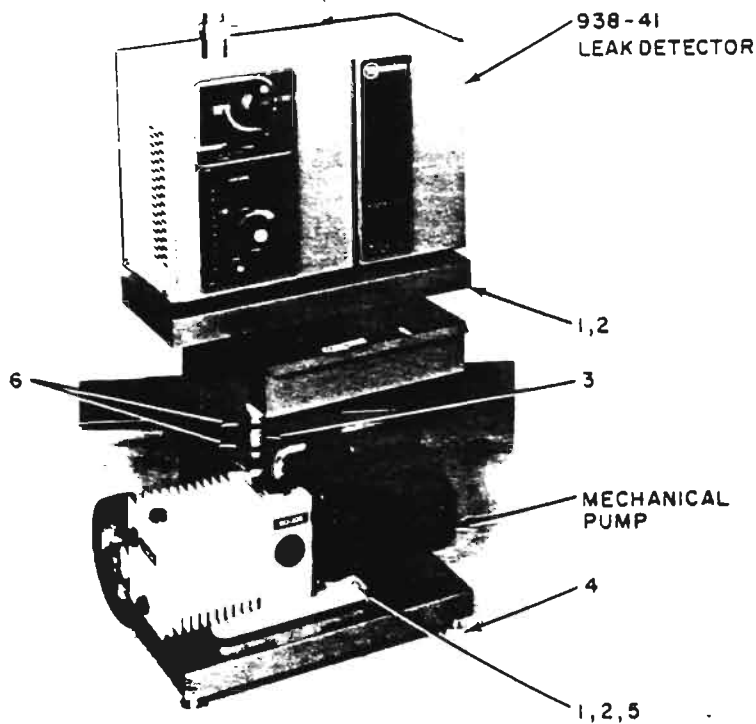

Fig. 8-12. Cart Model, Front View

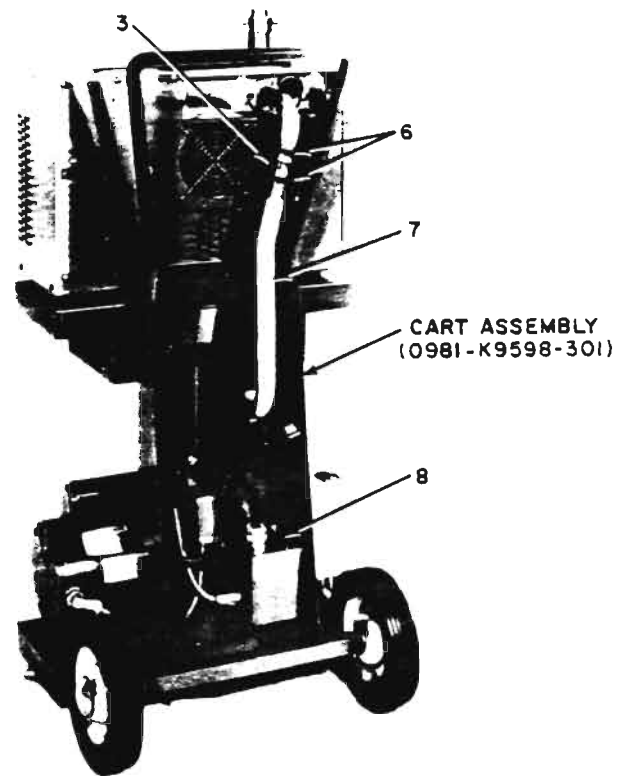

Fig. 8-13. Cart Model, Rear View

CART MODEL, FRONT AND REAR VIEWS (Figs. 8-12, 8-13)

Item	Description	Varian Ordering Number
1	Hex Head Screw, 1/4-20 UNC-2Ax1/2" long, s/s	0981-6121-10-198
2	Split Lockwasher, 1/4", s/s	0981-6182-10-026
3	Tubing, Tygon, 1" IDx1/4" Wallx2 1/2" long	0981-6331-20-115
4	Leveling Foot	0981-6700-28-024
5	Mount	0981-K9137-001
6	Hose Clamp	0981-6354-11-016
7	Manifold Assembly	0981-K9902-001
8	Circuit Breaker	
Pump and Voltage		
	7 or 11 cfm, 115V	0981-6431-85-006
	7 or 11 cfm, 230V	0981-6431-85-020
Heinemann No.		
	JA1-A22A-12.5-10, Single Pole, 12.5A	
	JA2-A22-6.5-10, Double Pole, 6.5A	

varian 
vacuum products

***Turbo-V 2000 ICE
controller***

**Model 969-9448
Model 969-9449**

MANUALE ISTRUZIONI

BEDIENUNGSHANDBUCH

NOTICE DE MODE D'EMPLOI

MANUAL DE INSTRUCCIONES

MANUAL DE INSTRUÇÕES

BEDRIJSHANDLEIDING

ISTRUKSTIONSBOG

BRUKSANVISNING

INSTRUKSJON MANUAL

OHJEKÄSIKIRJA

ΟΔΗΓΙΕΣ ΧΡΗΣΕΩΣ

INSTRUCTION MANUAL

SECTION IX. DIAGRAMS

This section contains schematics for the 938-41 Porta-Test Leak Detector. Detailed cabling and wiring diagrams, and integrated-circuit logic diagrams, are provided in a separate service manual (Varian Part No. 0981-6999-09-515).

VARIAN OFFERS THE MOST COMPLETE LINE OF VACUUM COMPONENTS IN THE INDUSTRY

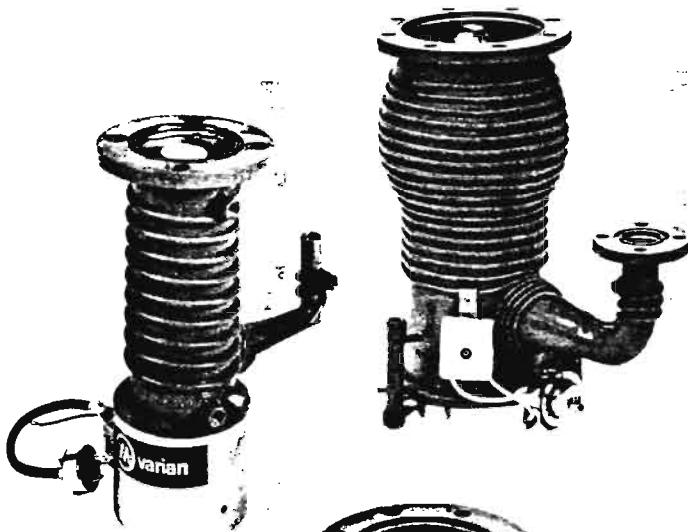

**DIFFUSION
PUMPS**

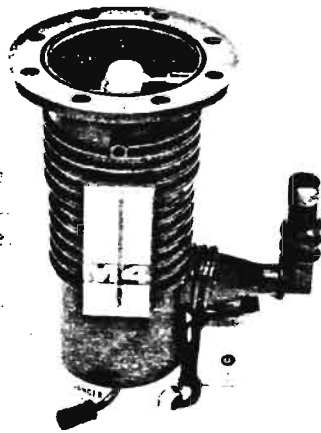

TRAPS AND BAFFLES

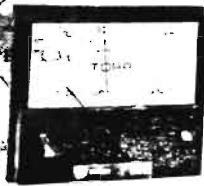
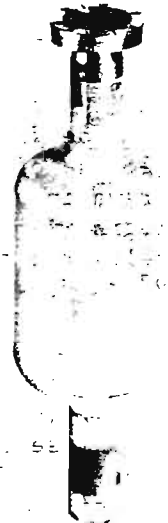
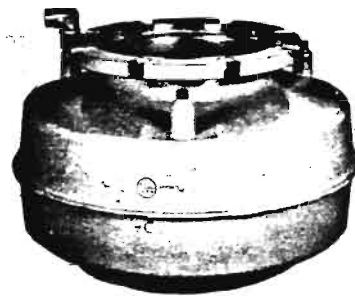

GAUGING

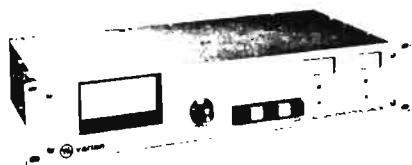

FEEDTHROUGHS

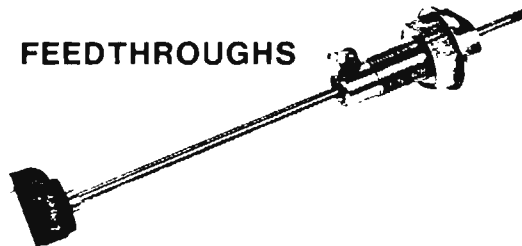

VALVES

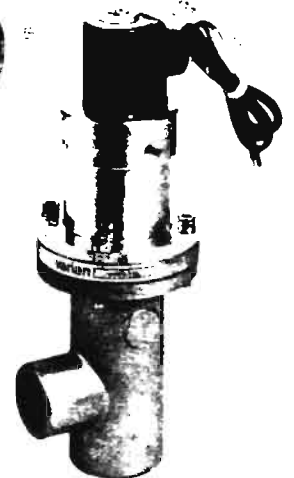

VARIAN OFFICES AND PLANTS

BOSTON*

331 Montvale Avenue
Woburn, MA 01810
Tel. 617/935-5185

CHICAGO*

708 Landwehr Road
Northbrook, IL 60062
Tel. 312/480-0300

CLEVELAND

333 Babbit Road
Euclid, OH 44123
Tel. 216/289-6365

DALLAS

13531 North Central Expressway
Suite 2343
Dallas, TX 75243
Tel. 214/235-4586

KNOXVILLE

320 Cedar Bluff Road
Knoxville, TN 37923
Tel. 615/690-3252

LOS ANGELES

9901 South Paramount Blvd.
Downey, CA 90240
Tel. 213/927-2601

ALBUQUERQUE*

2651 E. Pan American N.E.
Albuquerque, NM 87107
Tel. 505/344-8807

SERVICE CENTER

Varian I.E.G.
645 Clyde Avenue
Mountain View, CA 94043
Tel. 415/964-2790

PORTLAND

10700 S.W. Beaverton-
Hillsdale Hwy.
Bldg. 3 - Suite 585
Beaverton, OR 97005
Tel. 503/646-6626

NEW YORK

25 Commerce Drive
Cranford, NJ 07016
Tel. 201/499-7444

SAN FRANCISCO*

645 Clyde Ave.
Mt. View, CA 94043
Tel. 415/964-2790

LEXINGTON

121 Hartwell Avenue
Lexington, MA 02173
Tel. 617/861-7200

ST. PAUL

1306 West County Road F
St. Paul, MN 55112
Tel. 612/636-8036

SYRACUSE

6489 Ridings Road
Syracuse, NY 13206
Tel. 315/437-3307

WASHINGTON, D.C.

4701 Lydell Drive
Cheverly, MD 20785
Tel. 301/772-7433

PHOENIX

2750 South Hardy Drive
Suite 11
Tempe, AZ 85282
Tel. 602/941-2006

Varian SpA
Via Varian
10040 Leini
Torino, ITALY

*V.I.P. (Varian Industrial Products) Center

**INSTRUCTIONS FOR USE OF
TUNING LEAK
(0991-K1608-301)**

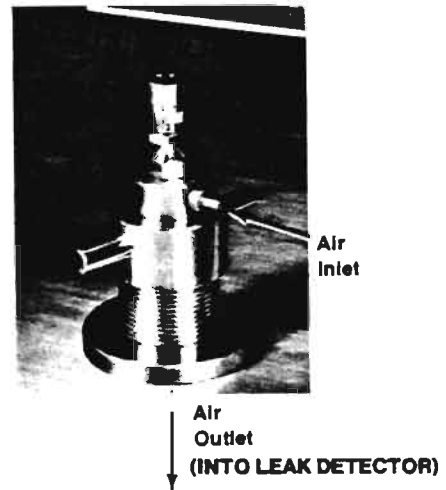

The Varian Tuning Leak is an uncalibrated source of helium designed to furnish an ample leak rate signal for tuning Varian leak detectors. The helium used by the Tuning Leak is the helium which occurs naturally in the air. The helium is normally present at a concentration of about 5 parts per million. The Tuning Leak admits a small amount of air into the leak detector, which is sensitive to the trace of helium. No separate supply of helium is necessary for use with this leak. Helium flow is controlled by a calibrated valve at the top of the tuning leak.

The Tuning Leak is not a calibrated source of helium. Its value in tuning the leak detector lies in the fact that it provides a signal a decade larger than that from a typical calibrated leak, hence it makes tuning the leak detector easier.

If the air in the vicinity of the Tuning Leak has a varying helium content, as might be the case if helium were being released nearby, the Leak Rate signal will not be stable. Variations in Leak Rate signals as drafts blow different helium concentrations past the Tuning Leak will make it difficult or impossible to tune the leak detector. One solution to this is to run a piece of tubing from the fitting on the side of the Tuning Leak to an area of stable helium concentration—perhaps out a window or through a roof. This should provide a steady meter deflection.

370

INSTRUCTIONS FOR USE OF THE POWER PROBE
(0991-K9565-301)

The Power Probe is a "sniffer" probe designed to locate leaks of helium from (for example) sealed containers pressurized internally with helium. The Power Probe requires no adjustment. It has a factory fixed conductance which permits a mechanical pump of between 7 and 11 cfm (200 l/m and 300 l/m) to maintain a test port pressure of approximately 100 milliTorr.

Operation: The test port adapter which is assembled to the clear plastic tubing of the Power Probe is designed to fit directly into the test port of the leak detector. Pumping out the Power Probe the first time and any time after it has been out of use will be fairly slow, perhaps requiring five minutes to reach 100 milliTorr. This is because of outgassing from the walls of the plastic tubing, slowed by air being drawn in at the probe tip. The maximum pressure at which use of the probe can begin (maximum tolerable test port pressure) is determined by the power being delivered to the diffusion pump. As received from the factory, the probe will be adjusted so that the test port pressure will be 80 to 120 milliTorr. The diffusion pump power should be turned to high (low sensitivity) and the adapter placed in the test port. If the test port pressure falls below 80 milliTorr, turn the operating handle to VENT and turn the adjusting screw on the probe counter-clockwise one full turn. Turn the operating handle to START and slowly turn the adjusting screw clockwise until the test port pressure is 100 milliTorr. Turn the operating handle to TEST. The probe is now ready to use. The leak rate display will immediately show a signal equivalent to a 10^{-6} std cc/sec leak. This is the leak detector's response to the helium naturally occurring in air (helium is about 5 parts per million in air). At this time the probe is ready for use. If the background signal is stable, it can be reduced by use of the zero and calibration adjustments: permitting the leak detector to operate on a more sensitive scale.

Application: The magnitude of the smallest leak which can be found with the Power Probe will depend on a number of factors. Most important is the traverse speed—the rate at which the operator sweeps the probe along a seam or other suspect zone. The distance of the probe from the workpiece will also affect the ability to locate a leak. Finally, fluctuations of the background signal will determine the smallest leak which can be distinguished from background.

The response time of the probe is approximately two seconds. In use, it is advisable to keep the tip of the Power Probe very slightly removed from the surface of the test piece to avoid sucking in materials clinging to the surface.

The Power Probe is resistant to plugging in normal use, but direct exposure to liquids will plug it, at least temporarily.

**INSTRUCTIONS
FOR
CALIBRATED HELIUM LEAK**
0991-F8473-301 (10⁻⁷ cc/sec range)
0991-F8473-302 (10⁻⁸ cc/sec range)



INTRODUCTION:

The calibrated helium leak is designed for use in calibrating helium leak detectors. It is equipped with an integral helium reservoir and an isolating valve, and is furnished with a 1-1/8 inch diameter sealing surface to fit the test port of any Varian Leak Detector.

USE:

The details of tuning and calibration of the leak detector are described in the appropriate section of the leak detector manual. When the calibrated leak is not in use, it should always be left with the valve **open**, and be stored at the same temperature at which it will be used.

PRINCIPLES OF OPERATION:

The helium reservoir consists of the nickel-plated cylinder to which the label adheres. The valve communicates with a hollow pyrex-glass finger which protrudes into the helium reservoir.

Helium atoms permeate through glass, moving through the inter-molecular spaces in the glass. This permeation rate is dependent on the pressure of helium on each side of the glass and on the area, thickness and temperature of the glass.

If the valve of the calibrating leak is left closed, helium will continue to leak into the glass finger until the helium pressure inside the finger is equal to that in the reservoir (this would take about a year, in fact). As this pressure builds up, however, helium would be absorbed on the metal walls, and the inter-molecular spaces in the glass will become saturated. For both these reasons, a high leak rate will be apparent for some time after re-opening the valve, so it is recommended that the valve be left open.

The leak rate of the calibrated leak is very stable, and is not affected by moisture or dust which can migrate in during periods of disuse. The leak rate is dependent of two effects, however.

A. Depletion. There is some finite depletion of the reservoir over time. This is a function of the leak rate and the volume of helium in the reservoir. The table below shows depletion rates in percent per year for some typical leak rates. Note that the 0991-F8473-301 is charged with 2.7 atmosphere of pressure, while the -302 has only one atmosphere.

P/N Suffix	Nominal Leak Rate	Depletion % Per Year
-301	3×10^{-7}	3.5%
-301	2×10^{-7}	2.3%
-301	1×10^{-7}	1.2%
-302	8×10^{-8}	2.4%
-302	5×10^{-8}	1.5%
-302	3×10^{-8}	.9%
-302	1×10^{-8}	.3%

B. Temperature

The rate at which helium permeates through the pyrex is affected by the temperature of the glass. The actual leak rate increases with increased temperature at 3% per degree (celsius). About one tenth of this is attributable to increase of the helium pressure with increased temperature.

APPENDIX C

ACCESSORIES

This appendix contains information on the various accessories available for use with the Varian 938-41 Porta-Test Leak Detector.



Aplezon "L" Grease
(Order No. 5000-6954-00-004)



O-Ring Kit
(Order No. 0981-K7641-801)



14" DIA. BASE PLATE
(ORDER NO. 0981-85118-301)

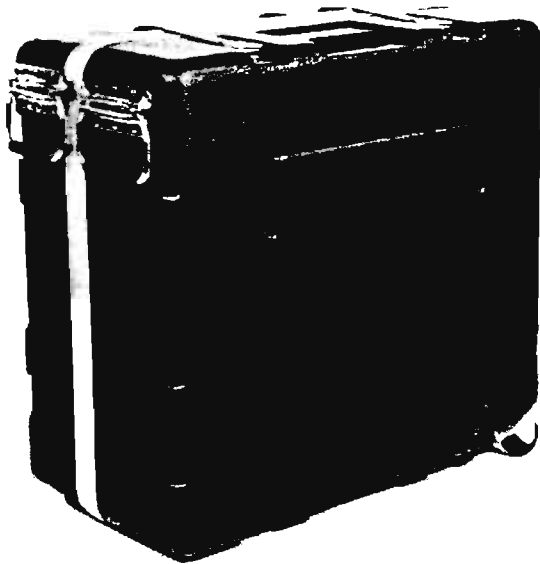

Traveling Case
(Order No. 0981-6999-09-053)

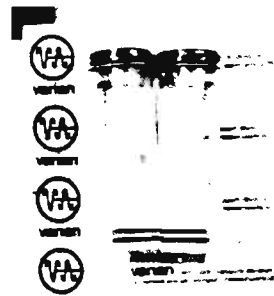

Spare Ion Source
(Order No. 0981-82850-301)
and
Spare Cathode Liners
(Order No. 0981-82849-008)

**INSTRUCTIONS FOR USE OF THE
HELIUM SPRAY PROBE
0991-K0167-301**

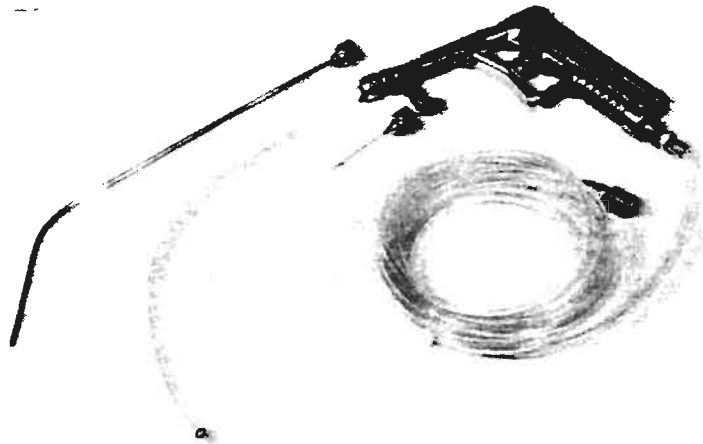

The helium spray probe is an accessory for use with Varian helium leak detectors. It is designed to control the position and rate of helium flow used to locate leaks in enclosures. The spray probe is furnished with three interchangeable tips and fittings to attach it to a low-pressure source of helium with either 1/8 FPT or 1/4 FPT outlet.

APPLICATION:

The helium spray probe is used in "outside-in testing" as defined in ASTM Standard Method E498-73. Basically this is a method for testing enclosures by evacuating the inside with a helium leak detector and spraying helium on suspect leak sites from the outside. In general this is done in two modes, first an all-over spray to see if there are leaks, then a fine spray to pin-point the location of leaks revealed in the first step.

The helium spray probe is equipped with a variable flow control: the knurled nut which limits the trigger travel can be set at the desired flow rate.

The plastic tube extension nozzle is useful for reaching inaccessible areas of a test piece with substantial flow rates. The one-foot copper tube extension can be pre-shaped to reach specific areas, including the bottom of drilled holes, etc. For the ultimate in pin-pointing leak sites, a 1½ inch long hypodermic needle is furnished. With extremely low helium flow this can locate a leak within .01 or .02 inches.

Appendix B

UNITS OF LEAKAGE RATE MEASUREMENT CONVERSION NOMOGRAM

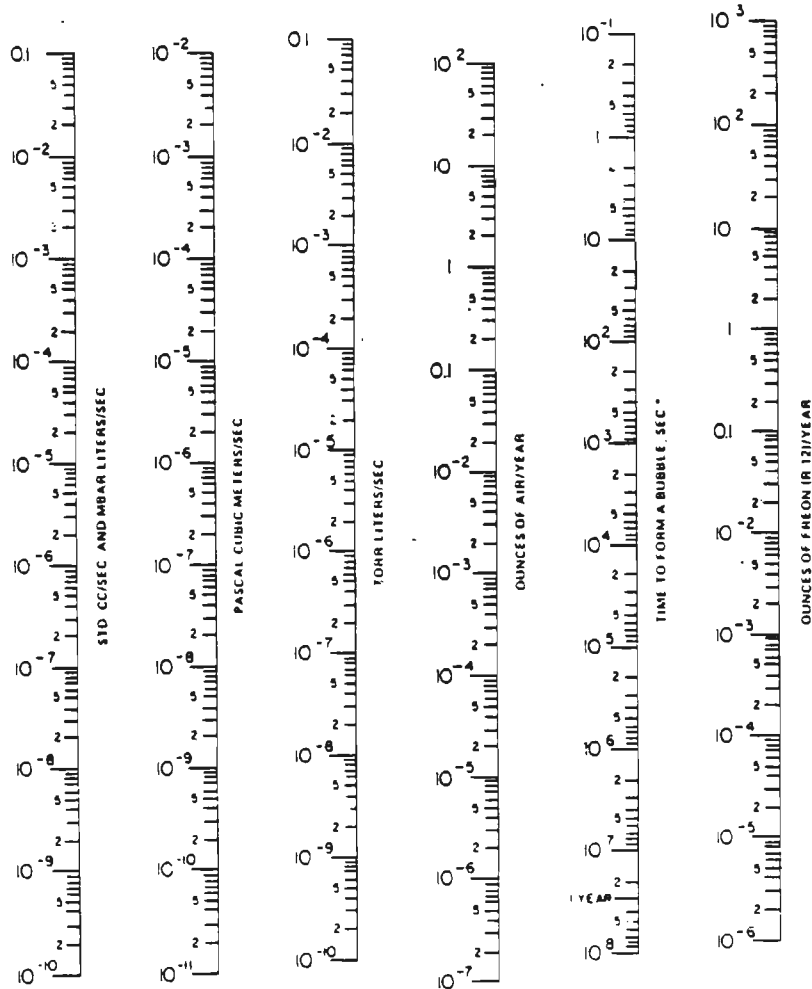

HORIZONTAL LINES REPRESENT EQUAL LEAK RATE VALUES

*For air in water bubble diameter approximately 1mm

Appendix A

UNITS OF PRESSURE MEASUREMENT CONVERSION NOMOGRAPH

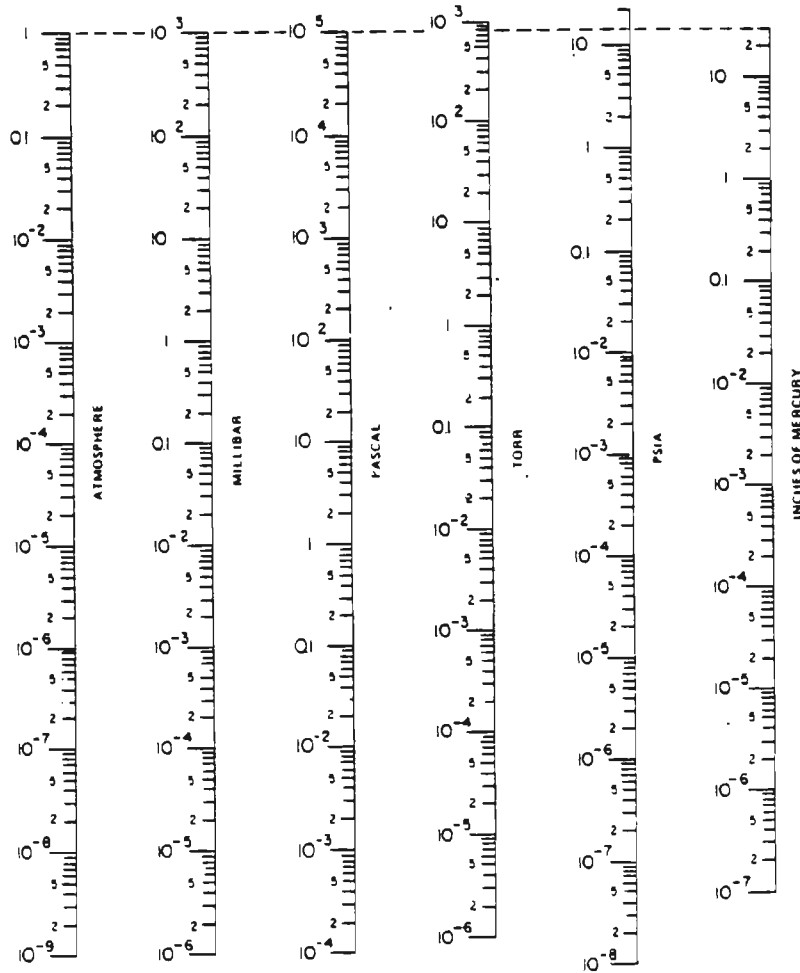

HORIZONTAL LINES REPRESENT EQUAL PRESSURE VALUES
1 atm = 760 Torr = 1013 mb = 101325 Pa = 14.7 psia = 29.9 in Hg

- Handling of a power loss during a normal test cycle will depend on the operation being performed at the time of the power failure. A general procedure to follow is given below.

1. Turn the operating handle to the START position and set the MAIN POWER and ELECT. switches in the off position (down).
2. When power is restored, follow the complete starting procedure in paragraph 3.6.5.

- If a circuit breaker is activated, reset it, and determine if power is being applied to the leak detector. If power is restored, turn the operating handle to the VENT position and set the ELECT. switch in the off position (down). Then follow the complete starting procedure in paragraph 3.6.5. If power is not restored (the breaker is again being activated), turn the operating handle to the START position, then set the MAIN POWER and ELECT. switches in the off position. In this last case, see Section V, Troubleshooting.

Because there is tube filament protection and a diffusion pump thermal switch (thermostat), and because Sanovac diffusion pump fluid is used, any type of power failure will not cause permanent damage to the diffusion pump or the spectrometer tube. At the most a minor temporary sensitivity loss may be observed.

3.7 OPERATING PRECAUTIONS

NOTE

Never leave the operating handle in the START position longer than 5 minutes after main power is applied.* If 5 minutes has elapsed, look at the green FIL. indicator.

- (1) If indicator is off and test port pressure exceeds 100 milliTorr, move operating handle counter-clockwise slowly to open-circle detent to restore vacuum in spectrometer tube. Then flip the FIL. switch to the ON position. The FIL. indicator should light. Move operating handle clockwise to START and continue operation.
- (2) If indicator is off and test port pressure is less than 100 milliTorr, move the operating handle clockwise to the TEST position. Then flip the FIL. switch to the ON position. The FIL. indicator should light. Move operating handle clockwise to START and continue operation.

*The pressure in the spectrometer tube may exceed 2×10^{-4} Torr with the result that the filament is extinguished. This could cause backstreaming of oil into the system.