

TSP Controller

Models

929-0032, 929-0033

User Manual

87-900-138-01 (A)

06/2014



Agilent Technologies

Notices

© Agilent Technologies, Inc. 2014

No part of this manual may be reproduced in any form or by any means (including electronic storage and retrieval or translation into a foreign language) without prior agreement and written consent from Agilent Technologies, Inc. as governed by United States and international copyright laws.

Manual Part Number

Publication Number: 87-900-138-01 (A)

Edition

Edition 06/2014

Printed in ITALY

Agilent Technologies Italia S.p.A.

Vacuum Products Division

Via F.lli Varian, 54

10040 Leini (TO)

ITALY

Warranty

The material contained in this document is provided “as is,” and is subject to being changed, without notice, in future editions. Further, to the maximum extent permitted by applicable law, Agilent disclaims all warranties, either express or implied, with regard to this manual and any information contained herein, including but not limited to the implied warranties of merchantability and fitness for a particular purpose. Agilent shall not be liable for errors or for incidental or consequential damages in connection with the furnishing, use, or performance of this document or of any information contained herein. Should Agilent and the user have a separate written agreement with warranty terms covering the material in this document that conflict with these terms, the warranty terms in the separate agreement shall control.

Technology Licenses

The hardware and/or software described in this document are furnished under a license and may be used or copied only in accordance with the terms of such license.

Restricted Rights Legend

If software is for use in the performance of a U.S. Government prime contract or subcontract, Software is delivered and licensed as “Commercial computer software” as defined in DFAR 252.227-7014 (June 1995), or as a “commercial item” as defined in FAR 2.101(a) or as “Restricted computer software” as defined in FAR 52.227-19 (June 1987) or any equivalent agency regulation or contract clause. Use, duplication or disclosure of Software is subject to Agilent Technologies’ standard commercial license terms, and non-DOD Departments and Agencies of the U.S. Government will receive no greater than Restricted Rights as

defined in FAR 52.227-19(c)(1-2) (June 1987). U.S. Government users will receive no greater than Limited Rights as defined in FAR 52.227-14 (June 1987) or DFAR 252.227-7015 (b)(2) (November 1995), as applicable in any technical data.

Trademarks

Windows and MS Windows are U.S. registered trademarks of Microsoft Corporation.

Safety Notices

CAUTION

A **CAUTION** notice denotes a hazard. It calls attention to an operating procedure, practice, or the like that, if not correctly performed or adhered to, could result in damage to the product or loss of important data. Do not proceed beyond a **CAUTION** notice until the indicated conditions are fully understood and met.

WARNING

A **WARNING** notice denotes a hazard. It calls attention to an operating procedure, practice, or the like that, if not correctly performed or adhered to, could result in personal injury or death. Do not proceed beyond a **WARNING** notice until the indicated conditions are fully understood and met.

Sublimation Controller



Sublimation Controller

Contents

Sublimation Controller 3

Contents 5

1 Istruzioni per l'uso 9

Informazioni Generali 10

Descrizione del Controller 11

Immagazzinamento 12

Preparazione per l'installazione 13

Installazione 15

Uso 16

Procedure di Uso 20

Manutenzione 22

Smaltimento 23

Messaggi di Errore 24

2 Gebrauchsanleitung 27

Allgemeines 28

Beschreibung des Controllers 29

Lagerung 30

Vor der Installation 31

Installation 33

Gebrauch 34

Bedienung 38



1 Istruzioni per l'uso

Descrizione del Controller

Wartung 40
Entsorgung 41
Störungsmeldungen 42

3 Mode d'emploi 43

Indications Generales 44
Description du Controleur 45
Emmagasinage 46
Preparation pour l'Installation 47
Installation 49
Utilisation 50
Procedures d'Utilisation 54
Entretien 56
Mise au Rebut 57
Messages d' Erreur 58

4 Instructions for Use 59

General Information 60
Controller Description 61
Storage 62
Preparation for Installation 63
Installation 65
Use 66
Operating Procedures 70
Maintenance 72
Disposal 73
Error Messages 74

5 Technical Information 75

Sublimation Controller Description	77
Sublimation Controller Specification	79
Sublimation Controller Outline	80
Pump Connection (J6 connector)	81
Remote I/O Connection (P5 connector)	82
Serial Port (J2 connector)	83
SERIAL CABLE INSTALLATION	84
Use	86
Sublimation Controller Configuration	86
Operating Mode Selection	93
Sublimation Parameters Setting	95
Parameters Values	99
Sublimation	99
Operation in MANUAL Mode	101
Operation in AUTOMATIC Mode	102
Operation in REMOTE SET Mode	102
Operation in AUTOMAT/REMOTE Mode	103
Sublimation Timing	103
Operational Flow-Chart	103
FRONT PANEL LEDs MEANING	105
SERIAL COMMUNICATION PROTOCOL	106
Serial Communication Protocol	106

1 Istruzioni per l'uso

Descrizione del Controller

LETTER PROTOCOL DESCRIPTION	107
Communication Format	107
Communication Protocol	107
Example of TSP Messages	112
Window Protocol Description	113
Window-Meanings	118
Orderable parts	121

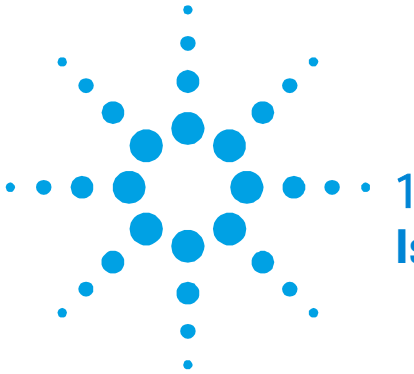

1 Istruzioni per l'uso

Informazioni Generali	10
Descrizione del Controller	11
Immagazzinamento	12
Preparazione per l'installazione	13
Installazione	15
Uso	16
Controlli ed Indicatori del Pannello Frontale del Sublimation Controller	18
Pannello Posteriore del Sublimation Controller	19
Procedure di Uso	20
Modi di Funzionamento	20
Accensione del Sublimation Controller	21
Spegnimento del Sublimation Controller	22
Manutenzione	22
Smaltimento	23
Messaggi di Errore	24

Traduzione delle istruzioni originali

Informazioni Generali

Questa apparecchiatura è destinata ad uso professionale. L'utilizzatore deve leggere attentamente il presente manuale di istruzioni ed ogni altra informazione addizionale fornita dalla Agilent prima dell'utilizzo dell'apparecchiatura. La Agilent si ritiene sollevata da eventuali responsabilità dovute all'inosservanza totale o parziale delle istruzioni, ad uso improprio da parte di personale non addestrato, ad interventi non autorizzati o ad uso contrario alle normative nazionali specifiche.

Nei paragrafi seguenti sono riportate tutte le informazioni necessarie a garantire la sicurezza dell'operatore durante l'utilizzo dell'apparecchiatura. Informazioni dettagliate sono fornite nell'appendice "Technical Informations".

Questo manuale utilizza le seguenti convenzioni:

ATTENZIONE! I messaggi di attenzione sono visualizzati prima di procedure che, se non osservate, potrebbero causare danni all'apparecchiatura.

AVVERTENZA! I messaggi di avvertenza attirano l'attenzione dell'operatore su una procedura o una pratica specifica che, se non eseguita in modo corretto, potrebbe provocare gravi lesioni personali.



NOTA

Le note contengono informazioni importanti estrapolate dal testo.

Descrizione del Controller

Il Sublimation Controller della Agilent è un controller per le pompe a sublimazione di titanio (TSP). L'unità può essere configurata in fabbrica a seconda delle necessità del cliente, ma la configurazione può essere modificata anche dal cliente per consentire l'adattamento a esigenze diverse.

Tab. 1

Descrizione	Numero di parte
Unità Base	
Sublimation Controller predisposto per una tensione di alimentazione di 220 Vac	929-0033
Sublimation Controller predisposto per una tensione di alimentazione di 110 Vac	929-0032
Accessori	
Cavo per pompa TSP	924-0730
Cavo per pompa Mini Ti-Ball	924-0752

Il Sublimation Controller può controllare una pompa del tipo a sublimazione di titanio (TSP) oppure del tipo Mini Ti-Ball.

Il Sublimation Controller ha diversi modi di funzionamento: MANUAL, AUTOMATIC, AUTOMAT/REMOTE e REMOTE SET.

Nei modi MANUAL e AUTOMATIC tutti i comandi sono dati tramite il pannello frontale. Nei modi REMOTE SET e AUTOMAT/REMOTE alcuni comandi sono dati tramite il pannello frontale ed altri mediante segnali sul connettore di I/O.

Immagazzinamento

Per trasportare e immagazzinare il controller occorre osservare le seguenti condizioni ambientali:

- Temperatura: da -20 °C a +70 °C
- Umidità relativa: 0 – 95 % (non condensante)

Preparazione per l'installazione

Il Sublimation Controller viene fornito in un imballo protettivo speciale; se si presentano segni di danni, che potrebbero essersi verificati durante il trasporto, contattare l'ufficio vendite locale.

Durante l'operazione di disimballaggio, prestare particolare attenzione a non lasciar cadere il controller e a non sottoporlo ad urti o vibrazioni.

Non disperdere l'imballo nell'ambiente. Il materiale è completamente riciclabile e risponde alla direttiva 94/62/CE e successivi emendamenti.



Figura 1 Imballo del controller

Il Sublimation Controller è predisposto in fabbrica per le seguenti tensioni di alimentazione:

- modello 929-0033 per 220 Vac (tensione di ingresso da 190 a 230 Vac).
- modello 929-0032 per 120 Vac (tensione di ingresso da 110 a 130 Vac).

1 Istruzioni per l'uso

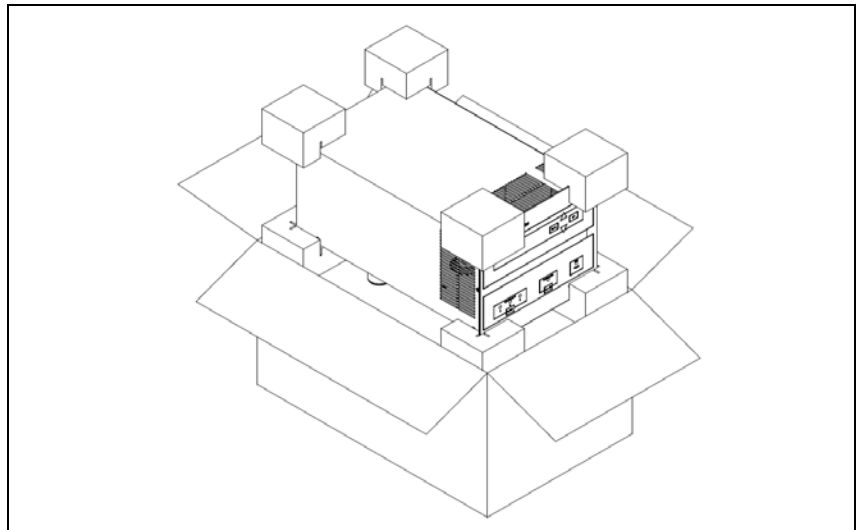
Preparazione per l'installazione

Nel caso in cui fosse necessario cambiare la tensione di alimentazione, eseguire la seguente procedura:

- 1 Spegnere il Sublimation Controller e staccare il cavo di alimentazione dal Controller.
- 2 Nel pannello posteriore, impostare il selettore di tensione nella posizione desiderata.

ATTENZIONE!

Se la selezione della tensione di ingresso viene portata da 100-120 Vac a 220-240 Vac, o viceversa, DEVONO essere cambiati anche i fusibili ed il cavo di alimentazione. Per le tensioni 220-240 Vac i fusibili devono essere T8A, mentre per le tensioni 100-120 Vac devono essere T15A.

- 3 Se necessario, cambiare i fusibili ed il cavo di alimentazione. Se occorre cambiare il cavo di alimentazione, esso va cablato nel seguente modo:

blu = neutro

marrone = fase

giallo verde = terra

- 4 Collegare il cavo di alimentazione al Controller.



Figura 2 Selettore tensione nominale

Installazione

AVVERTENZA!

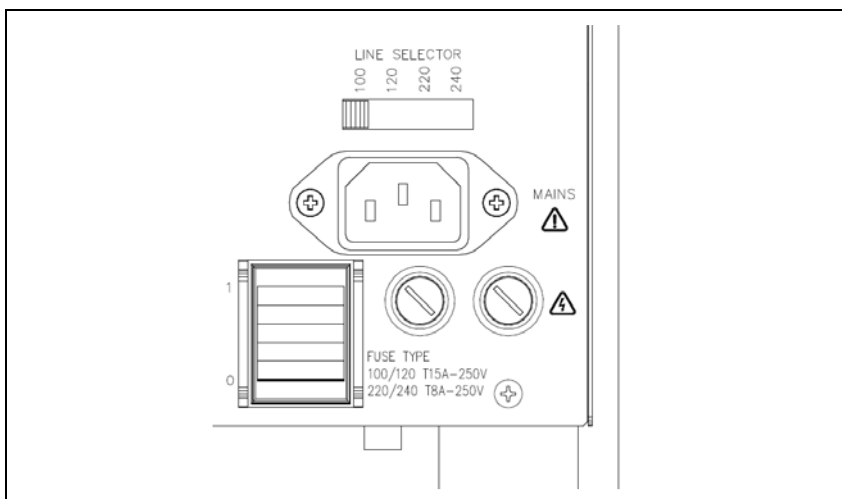

Il Sublimation Controller è munito di un cavo di alimentazione a 3 fili con una spina di sicurezza (approvata a livello internazionale). Utilizzare questo cavo di alimentazione e spina insieme ad una presa munita di collegamento di terra, onde evitare folgorazioni. Verificare che il collegamento di terra sia collegato correttamente. All'interno del controller si sviluppano alte tensioni che possono recare gravi danni o la morte. Prima di eseguire qualsiasi operazione di installazione o manutenzione del controller scollegarlo dall'alimentazione.

ATTENZIONE!

Il Sublimation Controller può essere usato sia come unità da tavolo sia come modulo a rack, in ogni caso deve essere posizionato in modo tale che l'aria possa circolare liberamente attraverso i fori di areazione presenti sulla copertura superiore e laterale. Se il Sublimation Controller viene utilizzato come modulo a rack, DEVE essere inserito in un adattatore alto quattro unità rack per evitare che cada all'interno del rack stesso. Il pannello frontale del Sublimation non è previsto per reggere il peso dell'unità. Non installare o utilizzare il Sublimation Controller in un ambiente esposto ad agenti atmosferici (pioggia, neve, ghiaccio), polvere, gas corrosivi, o in un ambiente esplosivo o ad alto rischio di infiammabilità.

NOTA

Se il Sublimation Controller è utilizzato come unità da tavolo, devono essere presenti i quattro piedini laterali. Se il Sublimation Controller è installato in un rack, rimuovere i quattro piedini e posizionarlo con almeno 30 mm (1,2 pollici) di spazio sopra e sotto.

1 Istruzioni per l'uso

Uso

Durante il funzionamento, occorre che siano rispettate le seguenti condizioni ambientali:

- temperatura: da +5 °C a +45 °C,
- umidità relativa: 0 – 90 % (senza condensa).

Per collegare il Sublimation Controller alla pompa utilizzare il cavo specifico fornito come opzione. Per informazioni su questi ed altri collegamenti e sull'installazione della scheda opzionale consultare l'appendice "Technical Information".

Uso

In questo paragrafo sono riportate le principali procedure operative. Per ulteriori dettagli e per procedure che coinvolgono collegamenti o particolari opzionali, fare riferimento al paragrafo "Use" dell'appendice "Technical Information".

Prima dell'utilizzo effettuare tutti i collegamenti elettrici del controller e della pompa e fare riferimento al manuale della pompa collegata. Leggere attentamente anche tale manuale prima dell'utilizzo del sistema.

AVVERTENZA!



Per evitare danni alle persone ed all'apparato, nel caso in cui la pompa sia appoggiata su un tavolo assicurarsi che sia stabile. Non far funzionare mai la pompa se la flangia di ingresso non è collegata al sistema o non è chiusa con la flangia di chiusura.

Controlli ed Indicatori del Pannello Frontale del Sublimation Controller

La figura seguente illustra il pannello frontale del Sublimation Controller. Il significato e la funzione dei controlli e degli indicatori è dettagliato nella seguente tabella.



Figura 3 Controlli ed Indicatori del Pannello Frontale del Sublimation Controller

Rif.	Nome del Controllo/Indicatore	Descrizione del Controllo/Indicatore
1		Display LCD a matrice di punti retroilluminato, 16 caratteri 2 righe.
2	TSP FILAMENT 1, 2, 3	Led blu che indicano: <ul style="list-style-type: none"> • se accesi, la selezione del corrispondente filamento della pompa TSP, • se lampeggianti, che il corrispondente filamento della pompa TSP è interrotto.
3	SELECT	Pulsante per la selezione manuale di uno dei 3 filamenti della pompa TSP.

1 Istruzioni per l'uso

Uso

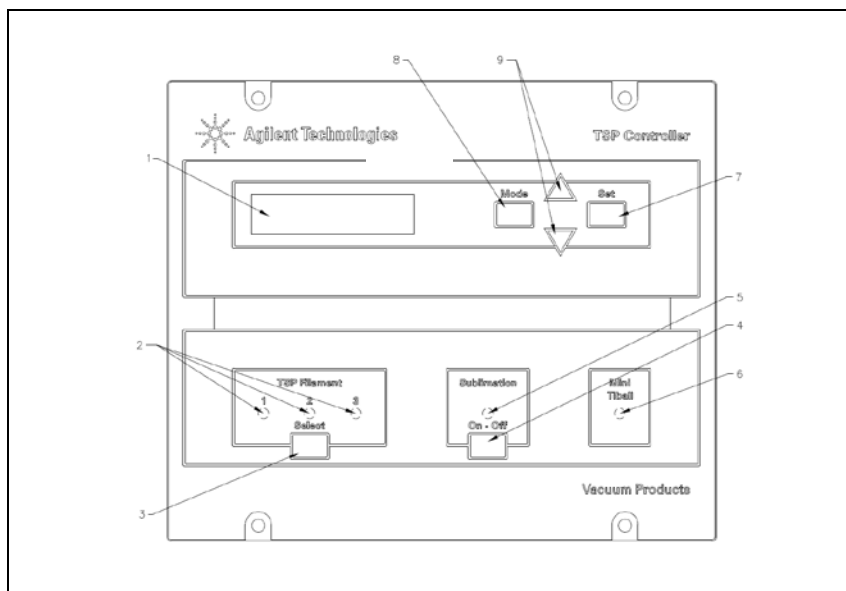
Rif.	Nome del Controllo/Indicatore	Descrizione del Controllo/Indicatore
4	ON/OFF	Pulsante per la commutazione del modo di funzionamento del controller: <ul style="list-style-type: none">• su OFF il è attivo il modo "Impostazione Parametri"• su ON è attivo il modo "Sublimazione".
5	SUBLIMATION	Led blu che indica: <ul style="list-style-type: none">• se acceso, che si è nel tempo di attesa fra 2 sublimazioni o nella fase di rampa di corrente;• se lampeggiante, che è in corso la sublimazione.
6	MINI TIBALL	Led blu acceso quando è selezionato il modo di funzionamento per Mini Ti-Ball.
7	SET	Pulsante che, a seconda dei casi, permette di: <ul style="list-style-type: none">• confermare l'inizio della sublimazione;• memorizzare le selezioni fatte;• resettare una situazione di Errore.
8	MODE	Pulsante che, a seconda dei casi, permette di: <ul style="list-style-type: none">• selezionare il modo di funzionamento (MANUAL, AUTOMATIC, AUTOMAT/REMOTE e REMOTE SET);• uscire dalle pagine di impostazione parametri senza cambiare i parametri.
9	[▲ / ▼]	Pulsanti che servono a modificare i valori nelle pagine di impostazione parametri.

Pannello Posteriore del Sublimation Controller

La figura seguente mostra i controlli e le connessioni del pannello posteriore del Sublimation Controller.



Figura 4 Pannello Posteriore del Sublimation Controller

1	Connettore per il collegamento del cavo della pompa
2	Connettore RS 232-485
3	Connettore per segnali di I/O
4	Selettore della tensione di linea
5	Connettore di alimentazione
6	Fusibili di protezione
7	Interruttore di alimentazione: acceso (I)/spento (O)

Procedure di Uso

Modi di Funzionamento

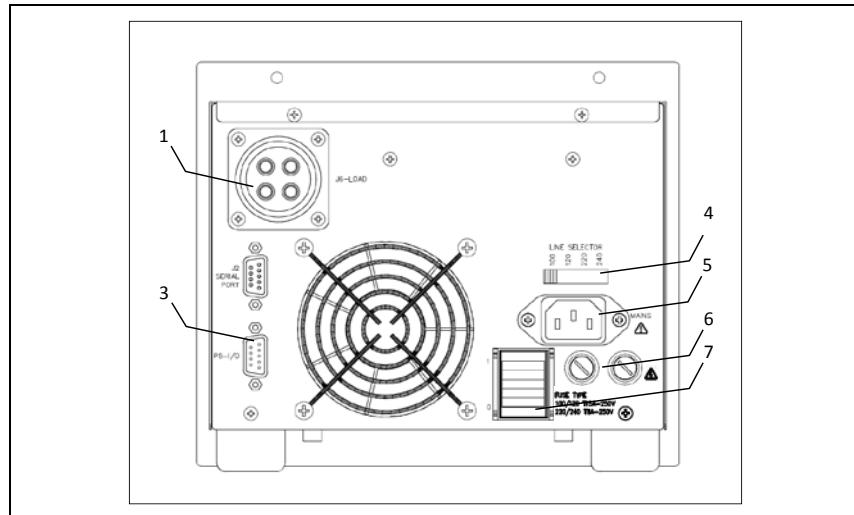
Il Sublimation Controller può funzionare nei modi **MANUAL**, **AUTOMATIC**, **REMOTE SET** e **AUTOMAT/REMOTE**.

Nei modi **MANUAL** e **AUTOMATIC** tutti i comandi sono dati da pannello frontale.

Nei modi di funzionamento **AUTOMAT/REMOTE** e **REMOTE SET** i comandi sono dati sia tramite segnali sul cavo di I/O sia dal pannello frontale.

NOTA

Dopo una interruzione dell'alimentazione il Sublimation ritorna sempre all'ultimo modo di funzionamento impostato. Se il parametro "AUTOSTART" è stato impostato su "YES" ed era in corso una sublimazione, questa riprenderà automaticamente.

L'unità è progettata per funzionare in due diversi modi:

- con la selezione manuale dei parametri (**MANUAL** e **REMOTE SET**)
- con la selezione automatica dei parametri (**AUTOMATIC** e **AUTOMAT/REMOTE**).

Il Sublimation Controller può essere usato per comandare le pompe del tipo TSP oppure del tipo Mini Ti-Ball.

Nei modi **MANUAL** e **REMOTE SET** la selezione dei parametri della sublimazione viene effettuata direttamente dall'operatore, attraverso i comandi del pannello frontale (modo **MANUAL**) o inviati sul connettore di I/O (modo **REMOTE**).

Se il Sublimation Controller deve essere usato in abbinamento a pompe del tipo TSP deve essere selezionato il tipo di sorgente TSP. Se il controller deve essere usato in abbinamento a pompe del tipo Mini Ti-Ball deve essere selezionato il tipo di sorgente Mini Ti-Ball.

NOTA

L'unità è predisposta in fabbrica nel seguente modo:

- modo di funzionamento MANUAL
- tipo di sorgente TSP
- corrente di sublimazione 30 A
- tempo di sublimazione 1 minuto
- periodo di sublimazione 3 minuti
- livello di pressione 1×10^{-7} mbar
- "AUTOSTART" su YES (riavvio automatico della sublimazione dopo una mancanza di alimentazione)

Informazioni dettagliate sui modi di funzionamento sono contenute nell'appendice "Technical Information".

Accensione del Sublimation Controller

Per accendere il Sublimation Controller è sufficiente portare l'interruttore di alimentazione presente sul pannello posteriore nella posizione "1".

Per procedere con la sublimazione è sufficiente premere l'interruttore "SUBLIMATION" presente sul pannello frontale quindi premere ▲ o ▼ per commutare la visualizzazione in:

S	U	B	L	I	M	A	T	I	O	N					
◄	S	T	A	R	T		?		Y	E	S		M	A	N

Premere il tasto SET per avviare la sublimazione.

NOTA

Fino a quando la sequenza sopra descritta non sarà conclusa, la sublimazione non si avvierà e l'unità resterà in attesa dell'impostazione dei parametri.

Spegnimento del Sublimation Controller

Per spegnere il Sublimation Controller si deve procedere come segue:

- 1 premere il pulsante "SUBLIMATION" del pannello frontale (Led blu spento).
- 2 portare l'interruttore di alimentazione del pannello posteriore nella posizione "O".

Manutenzione

Il Sublimation Controller non richiede alcuna manutenzione. Qualsiasi intervento deve essere eseguito da personale autorizzato.

In caso di guasto è possibile usufruire del servizio di riparazione Agilent o del "Agilent advance exchange service", che permette di ottenere un controller nuovo in sostituzione di quello guasto.

AVVERTENZA!



Prima di effettuare qualsiasi intervento sul controller scollegare il connettore di alimentazione. In caso di guasto è possibile usufruire del servizio di riparazione Agilent o del "Agilent advanced exchange service", che permette di ottenere un controller in sostituzione di quello guasto.

Qualora un controller dovesse essere rottamato, procedere alla sua eliminazione nel rispetto delle normative nazionali specifiche.

Smaltimento

Significato del logo "WEEE" presente sulle etichette.

Il simbolo qui sotto riportato è applicato in ottemperanza alla direttiva CE denominata "WEEE".

Questo simbolo (**valido solo per i paesi della Comunità Europea**) indica che il prodotto sul quale è applicato, **NON** deve essere smaltito insieme ai comuni rifiuti domestici o industriali, ma deve essere avviato ad un sistema di raccolta differenziata. Si invita pertanto l'utente finale a contattare il fornitore del dispositivo, sia esso la casa madre o un rivenditore, per avviare il processo di raccolta e smaltimento, dopo opportuna verifica dei termini e condizioni contrattuali di vendita.

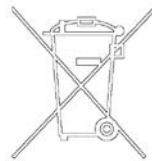

Messaggi di Errore

Per certi tipi di guasti il controller esegue una auto-diagnosi e visualizza uno dei messaggi mostrati nella tabella seguente.

Tab. 2

Messaggio	Descrizione	Azione correttiva
Power AC fail	Frequenza di alimentazione della rete non corretta.	Spegnere l'unità e verificare l'alimentazione della rete e la corretta impostazione del selettore di tensione.
Heater defective	Mini Ti-Ball scarico. La sublimazione è interrotta.	Sostituire il Mini Ti-Ball.
Filament x defective	Filamento X, dove X può essere 1, 2 o 3, interruzione (= filamento scarico) durante un ciclo di sublimazione con sorgente tipo TSP e parametro "TSP RECOVER" impostato su "MANUAL". La sublimazione sarà interrotta.	Selezionare manualmente un altro filamento non scarico oppure impostare il parametro "TSP RECOVER" su "AUTOMATIC"; in questa configurazione in cui un filamento si scarica, il software seleziona automaticamente uno dei restanti filamenti e il rispettivo LED si accenderà. Il LED corrispondente al filamento rilevato difettoso inizierà a lampeggiare.
Cartridge defective	Si è verificata una interruzione di tutti e tre i filamenti del TSP e la sublimazione viene interrotta.	Sostituire il cartridge.

Messaggio	Descrizione	Azione correttiva
Fault: overtem- perature	Sovratemperatura interna del Controller. La temperatura ambiente è troppo elevata oppure si verifica un sovraccarico esterno: la sublimazione è interrotta.	Verificare il carico (pompa e cavo) ed eliminare la causa del sovraccarico. Ridurre la temperatura ambiente.
External interlock	L'interlock non è collegato.	Collegare l'interlock: il pin 3 sul connettore I/O deve essere cortocircuitato su uno dei pin comuni (pin 6, 7, 8 o 9). È anche possibile collegare il connettore di accoppiamento fornito con il controller.

1 Istruzioni per l'uso
Messaggi di Errore

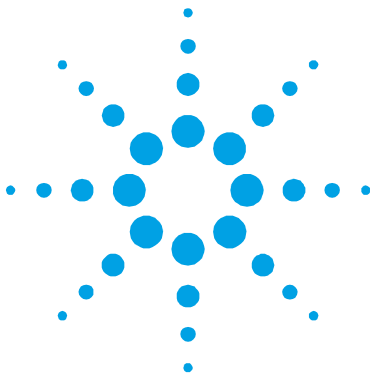

2 Gebrauchsanleitung

Allgemeines	28
Beschreibung des Controllers	29
Lagerung	29
Vor der Installation	31
Installation	33
Gebrauch	34
Schalter und Anzeigen auf der vorderen Schalttafel des Sublimation-Controllers	37
Hintere Schalttafel des Sublimation-Controllers	37
Bedienung	38
Betriebsarten	38
Zuschaltung des Sublimation Controllers	39
Abschaltung des Sublimation Controllers	40
Wartung	40
Entsorgung	41
Störungsmeldungen	42

Übersetzung der Originalanleitungen



Allgemeines

Dieser Apparat ist für Fachbetriebe bestimmt. Vor Gebrauch sollte der Benutzer dieses Handbuch sowie alle weiteren von Agilent mitgelieferten Zusatzdokumentationen genau lesen. Bei Nichtbeachtung - auch teilweise - der enthaltenen Hinweise, unsachgemäßem Gebrauch durch ungeschultes Personal, nicht autorisierten Eingriffen und Missachtung der einheimischen, hier zur Geltung kommenden Bestimmungen übernimmt die Firma Agilent keinerlei Haftung.

In den folgenden Abschnitten sind alle erforderlichen Informationen für die Sicherheit des Bedieners bei der Anwendung des Gerätes aufgeführt. Detaillierte technische Informationen sind im Anhang "Technical Information" enthalten.

In dieser Gebrauchsanleitung werden Sicherheitshinweise folgendermassen hervorgehoben:

VORSICHT!

Die Vorsichtshinweise vor bestimmten Prozeduren machen den Bediener darauf aufmerksam, dass bei Nichteinhaltung Schäden an der Anlage entstehen können.

WARNUNG!



Die Warnhinweise lenken die Aufmerksamkeit des Bedieners auf bestimmte Vorgänge oder Praktiken, die bei unkorrekter Ausführung schwere Verletzungen hervorrufen können.

HINWEIS

Die Hinweise enthalten wichtige Informationen, die im Text hervorgehoben werden.

Beschreibung des Controllers

Der Sublimation Controller von Agilent ist ein Controller für die Pumpen mit Titansublimation (TSP). Das Gerät kann im Werk nach den Angaben des Kunden voreingestellt werden, wobei im Werk voreingestellte Geräte vom Kunden den spezifischen Betriebsbedingungen entsprechend konfiguriert werden können.

Tab. 1

Bezeichnung	Best.-Nr.
Grundeinheit	
Sublimation-Controller, voreingestellt für Versorgungsspannung 220 V Ws	929-0033
Sublimation-Controller, voreingestellt für Versorgungsspannung 110 V Ws	929-0032
Zubehör	
Kabel für Pumpe TSP	924-0730
Kabel für Pumpe Mini Ti-Ball	924-0752

Der Sublimation-Controller kann zur Steuerung von Sublimationspumpen aus Titan (TSP) oder Pumpen der Baureihe Mini Ti-Ball eingesetzt werden.

Der Sublimation-Controller kann in den Betriebsarten MANUAL, AUTOMATISCH, AUTOMATISCH / FERNGESTEUERT und FERNGESTEUERT SET (voreingestellt) betrieben werden. In den Betriebsarten MANUAL und AUTOMATISCH werden die Steuerbefehle über die frontale Schalttafel des Controllers eingegeben; in den Betriebsarten AUTOMATISCH / FERNGESTEUERT und FERNGESTEUERT SET dagegen werden bestimmte Steuerbefehle über die frontale Schalttafel des Controllers eingegeben und andere über einen Verbindungsstecker und E/A-Signale übertragen.

2 **Gebrauchsanleitung**

Lagerung

Lagerung

Beim Transport und bei der Lagerung des Controllers müssen folgende klimatischen Verhältnisse eingehalten werden:

- Temperatur: -20 °C bis +70 °C
- Relative Luftfeuchtigkeit: 0 – 95 % (nicht kondensierend)

Vor der Installation

Der Controller wird mit einer speziellen Schutzverpackung geliefert. Eventuelle Transportschäden müssen der zuständigen örtlichen Verkaufsstelle gemeldet werden. Beim Auspacken vorsichtig vorgehen, damit der Controller nicht fällt oder Stößen ausgesetzt wird. Das Verpackungsmaterial muss korrekt entsorgt werden. Das Material ist zu 100% recycelbar und entspricht der EG-Richtlinie 94/62/CE sowie nachfolgenden Änderungen.



Abbildung 1 Verpackung des Controllers

Der Sublimation-Controller sind werkseitig für folgende Versorgungsspannungen ausgelegt:

- Modell 929-0033 für 220 V Ws (Eingangsspannung von 190 bis 230 V Ws);
- Modell 929-0032 für 120 V Ws (Eingangsspannung von 110 bis 130 V Ws).

Soll die Versorgungsspannung geändert werden, so gehen Sie wie folgt vor:

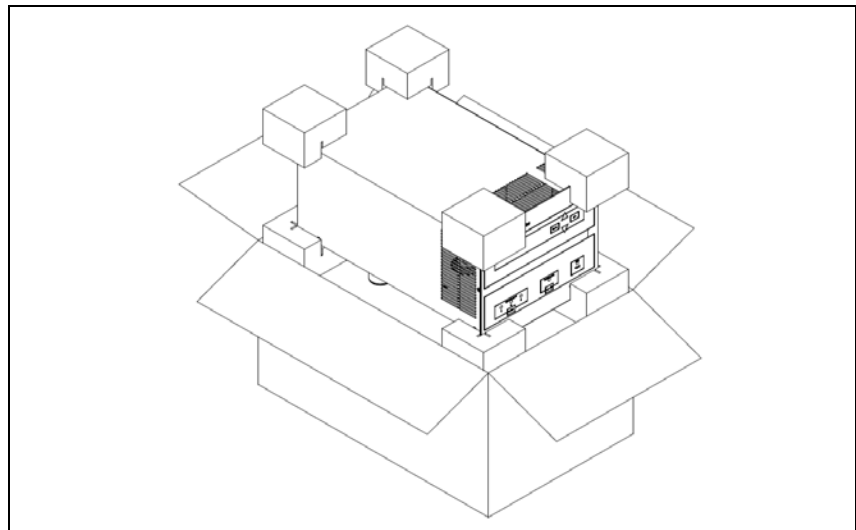
2 Gebrauchsanleitung

Vor der Installation

- 1 Schalten Sie den Sublimation Controller aus und ziehen Sie das Netzkabel aus dem Controller
- 2 Stellen Sie den Spannungswechsler auf der hinteren Schalttafel in die gewünschte Position.

VORSICHT!

Sollte die Versorgungsspannung von 100-120 V Ws auf 220-240 V Ws oder umgekehrt geändert werden, MÜSSEN IN JEDEM FALL auch die Sicherungen und das Netzkabel entsprechend ausgetauscht werden. Setzen Sie für eine Versorgungsspannung 220-240 V Ws Sicherungen vom Typ T8A und für eine Versorgungsspannung 100-120 V Ws T15A-Sicherungen ein.

- 3 Tauschen Sie immer, soweit erforderlich, die Sicherungen und das Netzkabel aus. Sollte ein Austausch des Netzkabels vorgenommen werden, so müssen die Leiter wie folgt angeschlossen werden:

blau = neutral
braun = Phase
grün-gelb = Erde

- 4 Stecken Sie das Netzkabel in den Controller.



Abbildung 2 Spannungsumschalter

Installation

WARNUNG!

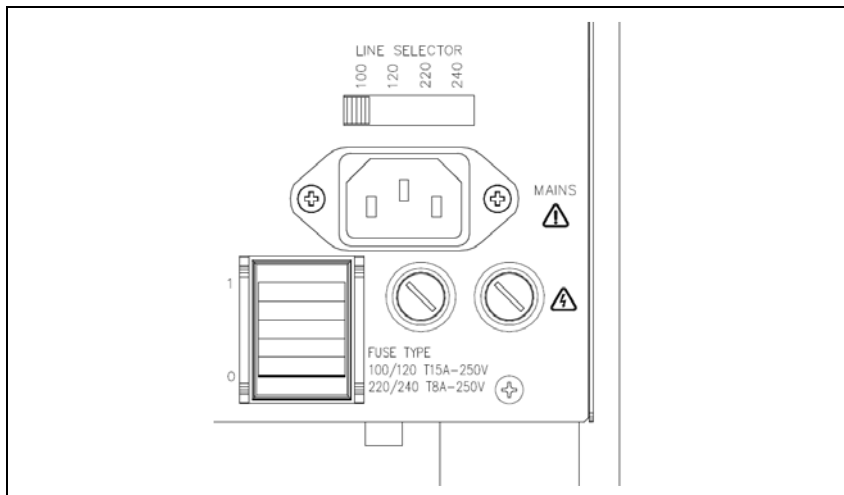

Der Sublimation-Controller wird mit einem Netzkabel mit 3 Leitern und mit einem den internationalen Normen entsprechenden Netzstecker geliefert. Es sollte immer dieses Netzkabel benutzt werden, das an eine vorschriftsmässig geerdete Steckdose anzuschliessen ist, um Stromentladungen zu vermeiden. Vergewissern Sie sich, dass das Gerät vorschriftsmässig geerdet ist. Im Inneren des Controllers entstehen hohe Spannungen, die schwere Schäden verursachen und lebensgefährlich sein können. Vor jedem Montage- bzw. Wartungseingriff muss deshalb der Netzstecker gezogen werden.

VORSICHT!

Der Controller kann auf einen Tisch oder ein Gestell montiert werden. In beiden Fällen muss eine ungehinderte Zirkulation der Kühlluft durch die im Gehäuse vorne und unten eingelassenen Luftöffnungen gewährleistet sein. Wenn der Controller in einem Gestell montiert wird, MUSS er in einer vier Rackeinheiten hohen Adapter-Einheit installiert werden, um zu vermeiden, dass der Controller nicht in das Gestell fällt. Die vordere Schalttafel des Sublimation-Controllers ist nicht geeignet, das gesamte Gewicht der Einheit zu tragen. Der Controller darf nicht in Umgebungen installiert u/o benutzt werden, die Witterungseinflüssen (Regen, Frost, Schnee), Staub und aggressiven Gasen ausgesetzt sind und in denen Explosions- und erhöhte Brandgefahr besteht.

HINWEIS

Zur Tischaufstellung des Controllers müssen die vier seitlichen Füsse ausgezogen werden. Wenn der Controller in einem Gestell installiert werden soll, müssen alle vier Füsse abmontiert werden; lassen Sie bei Rack-Installation des Controllers über- und unterhalb einen Raum von wenigstens 30 mm (1,2 Zoll).

2 Gebrauchsanleitung

Gebrauch

Während des Betriebs müssen folgende Umgebungsbedingungen eingehalten werden:

- Temperatur: von +0 °C bis +45 °C;
- Relative Luftfeuchtigkeit: 0 – 95 % (nicht kondensierend).

Für den Anschluss des Sublimation-Controllers an die Pumpe muss das zum Controller gehörende Kabel benutzt werden. Detailliertere Hinweise zu weiteren Anschlussarten sowie zum Einsatz der Zusatzkarte finden Sie im Anhang "Technical Information".

Gebrauch

In diesem Kapitel sind die wichtigsten Betriebsvorgänge aufgeführt. Für weitere Hinweise bezüglich Anschluss und Montage des bestellbaren Zubehörs verweisen wir auf das Kapitel "Use" im Anhang zu "Technical Information".

Vor Benutzung des Controllers müssen sämtliche elektrischen Anschlüsse des Controllers und der Pumpe ausgeführt und die Betriebsanleitung der angeschlossenen Pumpe genauestens durchlesen werden.

WARNUNG!



Steht die Pumpe auf einem Tisch, muss auf den stabilen Stand geachtet werden, da sonst die Gefahr von Personen- und Geräteschäden besteht. Die Pumpe nie einschalten, wenn der Eingangsflansch nicht am System angeschlossen bzw. nicht mit dem Schliessflansch abgedeckt ist.

Schalter und Anzeigen auf der vorderen Schalttafel des Sublimation-Controllers

Nachstehend wird die vordere Schalttafel des Sublimation-Controllers gezeigt. Die jeweilige Bedeutung und Funktion der Schalter und Anzeigen wird in der nachstehenden Tabelle beschrieben.



Abbildung 3 Schalter und Anzeigen auf der vorderen Schalttafel des Sublimation-Controllers

Pos.	Bezeichnung des Schalters / der Anzeige	Funktion des Schalters / der Anzeige
1		Rückbeleuchtetes LCD-Display, 16 Buchstaben, 2 Zeilen
2	TSP FILAMENT 1,2,3	Bedeutung der blaue LEDs: <ul style="list-style-type: none"> • Aufleuchten: Wahl des entspr. Glühdrahtes der TSP-Pumpe • Blinken: Unterbrechung des Glühdrahtes der TSP-Pumpe
3	SELECT	Druckschalter zur manuellen Selektion einer der 3 Glühdrahte der TSP-Pumpe

2 Gebrauchsanleitung

Gebrauch

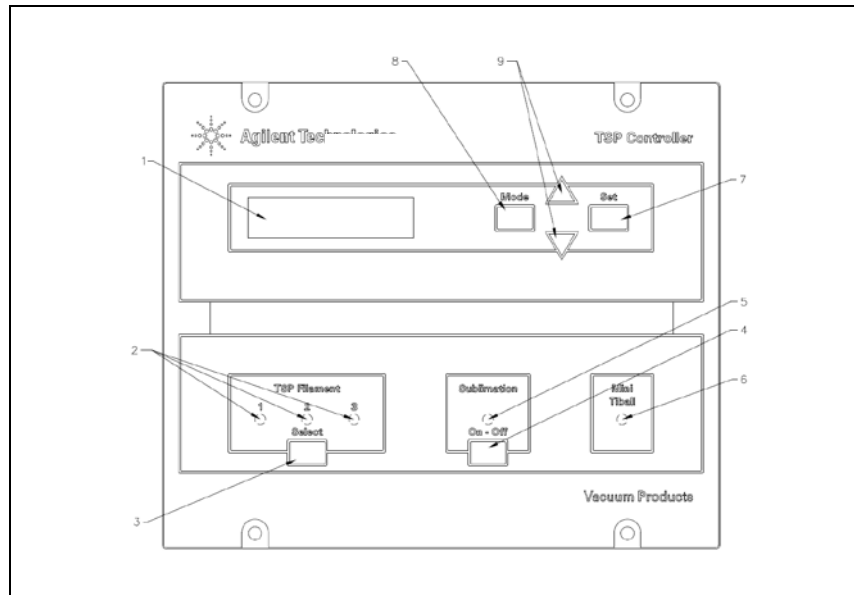
Pos.	Bezeichnung des Schalters / der Anzeige	Funktion des Schalters / der Anzeige
4	ON/OFF	Druckschalter zur Umschaltung der Betriebsart des Controllers: <ul style="list-style-type: none"> • OFF: Betriebsart "Parametereingabe" aktiv • ON: Betriebsart "Sublimationszyklus" aktiv
5	SUBLIMATION	Bedeutung des blaue LEDs: <ul style="list-style-type: none"> • Aufleuchten: Anzeige der Wartezeit zwischen 2 Sublimationen oder der Phase des Stromanstiegs • Blinken: Sublimation aktiv
6	MINI TIBALL	Das Aufleuchten des blauen LEDs steht für die Selektion der Betriebsart Mini Ti-Ball
7	SET	Druckschalter mit folgender Funktionsbelegung: <ul style="list-style-type: none"> • Bestätigung Sublimationsbeginn • Speicherung der Selektionen • Störungsrückstellung
8	MODE	Druckschalter mit folgender Funktionsbelegung: <ul style="list-style-type: none"> • Selektion der Betriebsart MANUAL, AUTOMATISCH, AUTOMATISCH / FERNGESTEUERT und FERNGESTEUERT SET • Absprung von der Seite "Parametereingabe" ohne Änderung der eingegebenen Parameter
9	[▼ / ▲]	Druckschalter zur Modifizierung der Werte auf den Seiten zur Parametereingabe

Hintere Schalttafel des Sublimation-Controllers

Die nebenstehende Abbildung zeigt die Schalter und Anschlussstellen der hinteren Schalttafel des Sublimation-Controllers.



Abbildung 4 Hintere Schalttafel des Sublimation-Controllers

- | | |
|---|--|
| 1 | Steckverbindung zum Anschluss des Pumpenkabels |
| 2 | Steckverbindung RS232-485 |
| 3 | Steckverbindung zum Anschluss der E/A-Signale |
| 4 | Spannungsschalter |
| 5 | Netzkabelanschluss |
| 6 | Sicherungen |
| 7 | Netzschalter: aufblinkend: EIN, nicht aufblinkend: AUS |

Bedienung

Betriebsarten

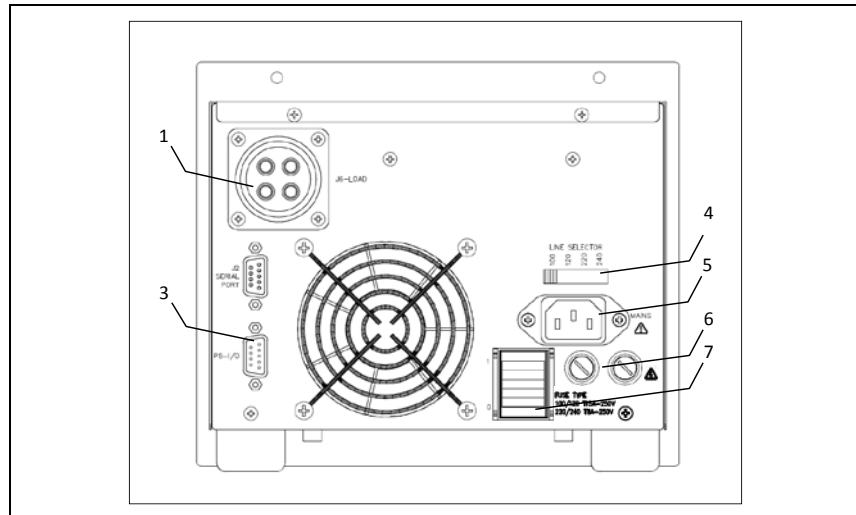
Der Sublimation-Controller kann in den Betriebsarten **MANUAL**, **AUTOMATISCH**, **AUTOMATISCH / FERNGESTEUERT** und **FERNGESTEUERT SET** (voreingestellt) betrieben werden.

In den Betriebsarten **MANUAL** und **AUTOMATISCH** werden die Steuerbefehle über die frontale Schalttafel des Controllers eingegeben; in den Betriebsarten **AUTOMATISCH / FERNGESTEUERT** und **FERNGESTEUERT SET** dagegen werden bestimmte Steuerbefehle über die frontale Schalttafel des Controllers eingegeben und andere über einen Verbindungsstecker und E/A-Signale übertragen.

HINWEIS

Nach einem Stromausfall wird der Sublimationsbetrieb immer in der jeweils zuletzt selektionierten Betriebsart aufgenommen. Wenn der Parameter "AUTOSTART" mit "YES" bestätigt wurde und der Sublimationsvorgang lief, wird dieser automatisch wieder aufgenommen.

Das Gerät kann auf zwei verschiedene Arten betrieben werden:

- über manuelle Selektion der Parameter (**MANUAL** und **FERNGESTEUERT SET**)
- über automatische Selektion der Parameter (**AUTOMATISCH** und **AUTOMATISCH / FERNGESTEUERT**).

Der Sublimation-Controller kann zur Steuerung von TSP-Pumpen oder Pumpen der Baureihe Mini Ti-Ball eingesetzt werden.

In den Betriebsarten **MANUAL** und **FERNGESTEUERT SET** wird die Selektion der Sublimationsparameter vom Bediener über die frontale Schalttafel des Controllers (Betriebsart **MANUAL**) vorgenommen oder über den Verbindungsstecker und entsprechende E/A-Signale (Betriebsart **FERNGESTEUERT**) übertragen.

Wenn der Sublimation Controller mit TSP-Pumpen verwendet wird, muss die Betriebsart TSP selektioniert werden. Wird der Sublimation Controller dagegen mit einer Mini Ti-Ball-Pumpe verwendet, so muss die Betriebsart Mini Ti-Ball eingestellt werden.

HINWEIS

Der Controller ist werkseitig wie folgt eingestellt:

- Bedienungsart MANUAL;
- Betriebsart für TSP-Pumpe;
- Sublimationsstrom 30A
- Sublimationszeit 1 Minute
- Sublimationsdauer 3 Minuten
- Druckpegel 1×10^{-7} mbar
- "AUTOSTART" Schalter auf "YES" (automatischer Neubeginn der Sublimation nach Stromausfall)

Nähere Informationen können Sie dem Anhang 'Technical Information' entnehmen.

Zuschaltung des Sublimation Controllers

Zur Zuschaltung des Sublimation Controllers muss der auf der hinteren Schalttafel installierte Netzschalter des Gerätes auf "1" gestellt werden. Zum Start des Sublimationszyklus, drücken Sie die "Sublimierung"-Taste auf der vorderen Schalttafel und drücken dann ▲ oder ▼, um die Anzeige zu ändern:

S	U	B	L	I	M	A	T	I	O	N				
↕	S	T	A	R	T	?	Y	E	S	M	A	N		

Drücken Sie die SET-Taste um den Sublimationszyklus zu beginnen.

HINWEIS

Solange die oben dargestellte Reihenfolge nicht abgeschlossen ist, wird der Sublimationszyklus nicht gestartet und das Gerät wartet auf die Einstellung der Parameter.

Abschaltung des Sublimation Controllers

Gehen Sie zur Abschaltung des Sublimation Controllers wie folgt vor:

- 1 Drücken Sie die "SUBLIMATION"-Taste auf der vorderen Schalttafel (blaues LED erlischt).
- 2 Stellen Sie den auf der hinteren Schalttafel präsenten Netzschalter" auf "0".

Wartung

Der Sublimation Controller ist wartungsfrei. Eventuell erforderliche Eingriffe müssen von dazu befugtem Fachpersonal ausgeführt werden.

Bei Störungen kann der Agilent-Reparaturdienst bzw. der "Agilent advanced exchange service" in Anspruch genommen werden, der für den Austausch defekter Controller sorgt.

WARNUNG!



Vor jedem Eingriff am Controller muss der Netzstecker gezogen werden. Bei Störungen kann der Agilent-Reparaturdienst bzw. der "Agilent advanced exchange service" in Anspruch genommen werden, der für den Austausch defekter Controller sorgt.

Eine eventuelle Verschrottung muss unter Einhaltung der einschlägigen landesüblichen Vorschriften erfolgen.

Entsorgung

Bedeutung des "WEEE" Logos auf den Etiketten.

Das folgende Symbol ist in Übereinstimmung mit der EU-Richtlinie WEEE (Waste Electrical and Electronic Equipment) angebracht.

Dieses Symbol (**nur in den EU-Ländern gültig**) zeigt an, dass das betreffende Produkt nicht zusammen mit Haushaltsmüll entsorgt werden darf sondern einem speziellen Sammelsystem zugeführt werden muss.

Der Endabnehmer sollte daher den Lieferanten des Geräts - d.h. die Muttergesellschaft oder den Wiederverkäufer - kontaktieren, um den Entsorgungsprozess zu starten, nachdem er die Verkaufsbedingungen geprüft hat.



Störungsmeldungen

In einigen Störungsfällen zeigt das Selbstdiagnosesystem des Controllers die in der nachstehenden Tabelle zusammengefassten Meldungen an.

Tab. 2

Meldung	Beschreibung	Störungsbehebung
Power AC fail	Falsche Netzfrequenz	Schalten Sie das Gerät AUS, überprüfen Sie die Stromversorgung und die richtige Einstellung des Spannungsschalters.
Heater defective	Die Mini Ti-Ball ist verbraucht. Der Sublimationszyklus wird unterbrochen.	Tauschen Sie die Mini Ti-Ball-Pumpe aus.
Filamet x Defective	Unterbrechung im Glühdraht X, entweder 1, 2 oder 3 (= Glühdraht verbraucht) während des Sublimationszyklus mit einer Quelle Typ TSP. Sollte der "TSP RECOVER" Parameter mit "MANUAL" eingegeben worden sein, wird der Sublimationszyklus unterbrochen.	Wählen Sie manuell einen anderen Glühdraht oder stellen Sie den "TSP RECOVER" Parameter auf "Automatisch"; mit dieser Konfiguration wählt bei einem verbrauchten Glühdraht die Software selbsttätig einen der weiteren Glühdrähte und zeigt dies über das entsprechende LED an. Das dem defekten Glühdraht entsprechende LED beginnt zu blinken.
Cartridge Defective	Unterbrechung eines oder aller Glühdrähte des TSP-Pumpe; Unterbrechung des Sublimationszyklus.	Tauschen Sie die Heizpatrone aus-.
Fault: overtemperature	Interner Übertemperaturregler. Die Umgebungstemperatur ist zu hoch oder es liegt eine externe Überlastung vor: Unterbrechung des Sublimationszyklus.	Überprüfen Sie die Überlastung (Pumpe und Kabel) und beseitigen Sie die Ursache der Überlastung. Reduzieren Sie die Umgebungstemperatur.
External Interlock	Kein Anschluss des Interlock-Kontaktes.	Schliessen Sie die Interlock an: die 3 Pins auf dem I/O-Anschluss müssen mit einem der üblichen Pins (Pins 6, 7, 8 oder 9) kurzgeschlossen werden. Es ist auch eine Verbindung mit dem Gegenstecker, der mit dem Controller geliefert wurde, möglich.

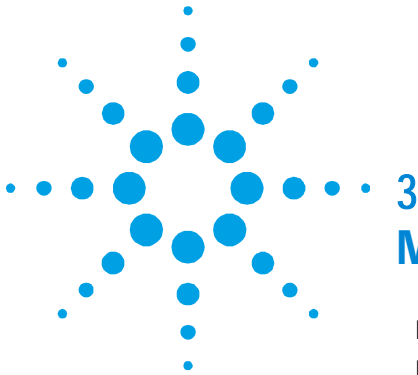

3 Mode d'emploi

Indications	44
Description du	45
Emmagasinage	46
Préparation pour l'Installation	47
Installation	49
Utilisation	50
Commandes et Voyants du Tableau Frontal du Sublimation Controller	54
Tableau Dorsal du Sublimation Controller	53
Procédures d'Utilisation	54
Modes de Fonctionnement	54
Mise sous Tension du Sublimation Controller	55
Mise Hors Tension du Sublimation Controller	56
Entretien	56
Mise au Rebut	57
Messages d'erreur	58

Traduction de la mode d'emploi original



Indications Générales

Cet appareillage a été conçu en vue d'une utilisation professionnelle. Il est conseillé à l'utilisateur de lire attentivement cette notice d'instructions ainsi que toute autre indication supplémentaire fournie par Agilent, avant l'utilisation de l'appareil. Agilent décline par conséquent toute responsabilité en cas d'inobservation totale ou partielle des instructions données, d'utilisation incorrecte de la part d'un personnel non formé, d'opérations non autorisées ou d'emploi contraire aux réglementations nationales spécifiques.

Les paragraphes suivants donnent toutes les indications nécessaires à garantir la sécurité de l'opérateur pendant l'utilisation de l'appareillage. Des renseignements plus détaillés se trouvent dans l'appendice "Technical Informations".

Cette notice utilise les signes conventionnels suivants:

ATTENTION!

Les messages d'attention sont affichés avant certaines procédures qui, si elles ne sont pas observées, pourraient endommager sérieusement l'appareillage.

AVERTISSEMENT!



Les messages d'avertissement attirent l'attention de l'opérateur sur une procédure ou une manœuvre spéciale qui, si elle n'est pas effectuée correctement, risque de provoquer de graves lésions.

NOTE

Les notes contiennent des renseignements importants, isolés du texte.

Description du Contrôleur

Le Sublimation Controller produit par Agilent est un contrôleur pour pompes à sublimation de titane (TSP). L'unité peut être configurée en usine selon les nécessités du client, mais la configuration peut également être modifiée par le client lui-même qui pourra l'adapter à des exigences diverses.

Tab. 1

Description	Num. de l'élément
Unité de Base	
Sublimation Controller prééquipé pour une tension d'alimentation de 220 Vac	929-0033
Sublimation Controller prééquipé pour une tension d'alimentation de 110 Vac	929-0032
Accessoires	
Câble pour pompe TSP	924-0730
Câble pour pompe Mini Ti-Ball	924-0752

Le Sublimation Controller peut commander une pompe du type à sublimation au titane (TSP) ou bien du type Mini Ti-Ball. Le Sublimation Controller est caractérisé par différents modes de fonctionnement: MANUAL, AUTOMATIC, AUTOMAT /REMOTE et REMOTE SET. Dans les modes MANUAL et AUTOMATIC, toutes les commandes sont données par tableau frontal. Dans les modes REMOTE SET et AUTOMAT/REMOTE, certaines commandes sont données par tableau frontal et d'autres par des signaux sur le connecteur d'E/S.

Emmagasinage

Pendant le transport et l'emmagasinage du contrôleur, il faudra veiller à respecter les conditions environnementales suivantes:

- température: de -20 °C à +70 °C
- humidité relative: de 0 % à 95 % (non condensante).

Préparation pour l'Installation

Le Sublimation Controller est fourni dans un emballage de protection spécial; si l'on constate des marques de dommages pouvant s'être produits pendant le transport, contacter aussitôt le bureau de vente local. Pendant l'opération d'ouverture de l'emballage, veiller tout particulièrement à ne pas laisser tomber le contrôleur et à ne lui faire subir aucun choc.

Ne pas jeter l'emballage dans la nature. Le matériel est entièrement recyclable et il est conforme aux directives 94/62/CE et suivantes.

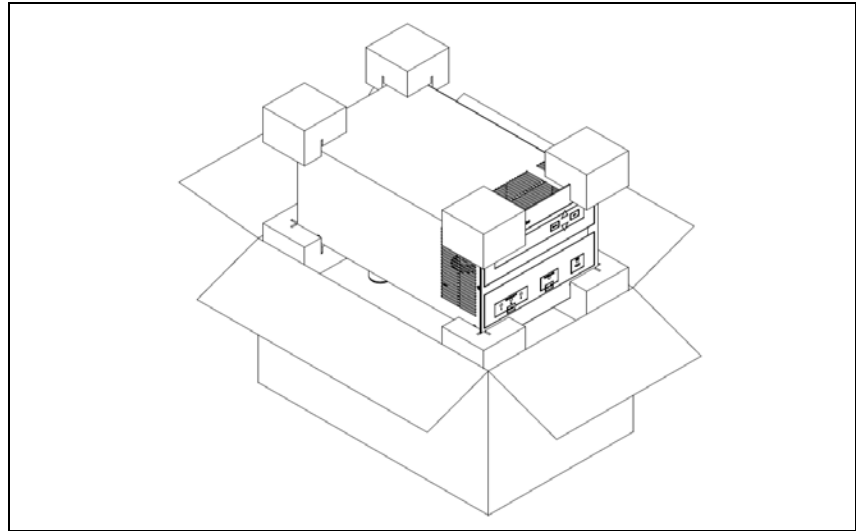

Figure 1 Emballage du contrôleur

Le Sublimation Controller est prééquipé en usine pour les tensions d'alimentation suivantes:

- modèle 929-0033 pour 220 Vac (tension d'entrée de 190 à 230 Vac)
- modèle 929-0032 pour 120 Vac (tension d'entrée de 110 à 130 Vac).

3 Mode d'emploi

Préparation pour l'Installation

S'il s'avère nécessaire de changer la tension d'alimentation, procéder comme suit:

- 1 Couper l'alimentation du Sublimation Controller et débrancher le câble d'alimentation du Controller.
- 2 À l'arrière du panneau, faire glisser le sélecteur vers la position voulue.

ATTENTION!

Si la sélection de la tension d'entrée est portée de 100-120 Vac à 220-240 Vac, ou vice-versa, IL EST NÉCESSAIRE de changer également les fusibles et le câble d'alimentation. Pour les tensions de 220-240 Vac, les fusibles doivent être T8A, tandis que pour les tensions 100-120 Vac, ils doivent être T15A.

- 3 Si besoin est, changer les fusibles et le câble d'alimentation. S'il apparaît nécessaire de changer le câble d'alimentation, celui-ci doit être câblé comme suit:

bleu = neutre
marron = phase
jaune vert = terre.

- 4 Remettre en place le survolteur-dévolteur ainsi que le cache porte-fusibles.
- 5 Connecter le câble d'alimentation au Controller.

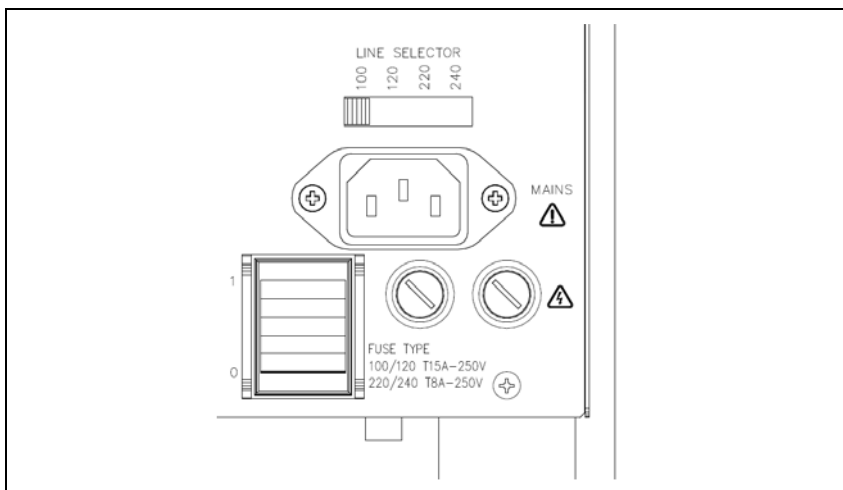

Figure 2 Sélecteur de tension nominale

Installation

AVERTISSEMENT!



Le Sublimation Controller est muni d'un câble d'alimentation à 3 fils, avec une fiche de sécurité (approuvée au niveau international). Utiliser ce câble d'alimentation et cette fiche avec une prise munie de connexion à la terre, afin d'éviter tout risque d'électrocution. S'assurer que la connexion à la terre soit correctement connectée. A l'intérieur du contrôleur se développent de hautes tensions qui peuvent causer de graves dommages et même la mort. Avant d'effectuer toute opération d'installation ou d'entretien du contrôleur, le débrancher de la prise d'alimentation.

ATTENTION!

Le Sublimation Controller peut être utilisé soit comme unité de table soit comme module à rack. Il doit, de toute façon, être positionné de façon à ce que l'air de refroidissement puisse circuler librement à travers les trous d'aération se trouvant sur la couverture supérieure et latérale. Si le Sublimation Controller est utilisé comme module à rack, Il DOIT être introduit dans un adaptateur haut de quatre unités de rack pour éviter qu'il ne tombe à l'intérieur du rack. Le tableau frontal du Sublimation Controller n'est pas prévu pour supporter le poids de l'unité. Ne pas installer ou utiliser le contrôleur dans des milieux exposés à des agents atmosphériques (pluie, gel, neige), à des poussières, à des gaz de combat ainsi que dans des milieux explosifs ou à risque élevé d'incendie.

NOTE

Si le Sublimation Controller est utilisé comme unité de table, il faut que les quatre pieds latéraux soient présents. Si le Sublimation Controller est installé dans un rack, enlever les quatre pieds ou bien le positionner avec 30 mm (1.2 pouces) d'espace au moins au-dessus et au-dessous).

3 Mode d'emploi

Utilisation

Pendant le fonctionnement, il est nécessaire de respecter les conditions d'environnement suivantes:

- température: de +5 °C à + 45 °C
- humidité relative: de 0 % à 95 % (non condensante).

Pour relier le Sublimation Controller à la pompe, utiliser le câble spécifique fourni en option. Pour tous renseignements concernant ces connexions et d'autres connexions ainsi que l'installation de la carte optionnelle, consulter l'appendice "Technical Information".

Utilisation

On indique, dans ce paragraphe, les principales procédures opérationnelles. Pour tous autres détails et pour les procédures concernant des connexions ou des éléments en option, se reporter au paragraphe "Use" de l'appendice "Technical Informations".

Avant d'utiliser le contrôleur, effectuer toutes les connexions électriques du contrôleur et de la pompe et se référer à la notice de la pompe connectée. Lire également cette notice avec attention avant d'utiliser le système.

AVERTISSEMENT!



Pour éviter tous dommages aux personnes et à l'appareil, si la pompe est placée sur une table d'appui, s'assurer que cette dernière est stable. Ne jamais faire fonctionner la pompe si la bride d'entrée n'est pas connectée au système ou n'est pas fermée à l'aide de la bride de fermeture.

Commandes et Voyants du Tableau Frontal du Sublimation Controller

La figure ci-dessous représente le tableau frontal du Sublimation Controller.

La signification et la fonction des commandes et des voyants sont indiquées dans le tableau de la page suivante.

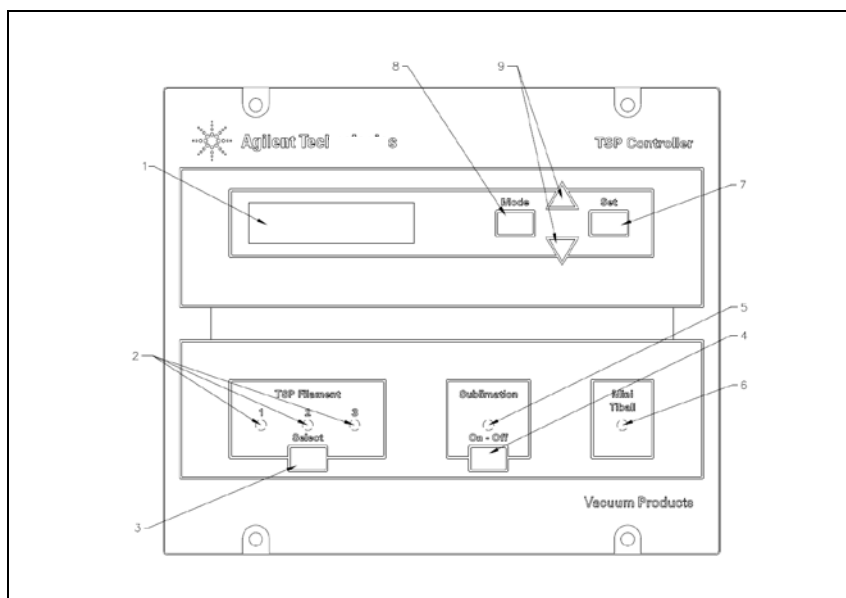

Figure 3 Commandes et Voyants du Tableau Frontal du Sublimation Controller

Réf.	Nom de la Commande/ du Voyant	Description de la Commande/du Voyant
1		Affichage à cristaux liquides à imprimante par points éclairé par l'arrière. 16 caractères 2 lignes.
2	TSP FILAMENT 1, 2, 3	Voyants bleus indiquant: <ul style="list-style-type: none"> • s'ils sont allumés: la sélection du filament correspondant de la pompe TSP, • s'ils clignotent: le filament correspondant de la

3 Mode d'emploi

Utilisation

Réf.	Nom de la Commande/ du Voyant	Description de la Commande/du Voyant
		pompe est coupé.
3	SELECT	Touche de sélection manuelle de l'un des trois filaments de la pompe TSP
4	ON/OFF	Bouton de commutation de mode de fonctionnement du contrôleur: <ul style="list-style-type: none">• sur OFF: le mode "Fixation des Paramètres" est actif• sur ON: le mode "Sublimation" est actif.
5	SUBLIMATION	Le voyant bleu indique: <ul style="list-style-type: none">• s'il est allumé: on est dans le temps d'attente entre 2 sublimations ou bien dans la phase de rampe de courant;• si elle clignote: la sublimation est en cours.
6	MINI TIBALL	Le voyant bleu s'allume lorsque le mode de fonctionnement pour Mini Ti-Ball est sélectionné.
7	SET	Bouton qui permet, selon les cas: <ul style="list-style-type: none">• de confirmer le début de la sublimation;• de mémoriser les sélections faites;• de mettre à zéro une situation d'Erreur.
8	MODE	Bouton qui permet, selon les cas: <ul style="list-style-type: none">• de sélectionner le mode de fonctionnement (MANUAL, AUTOMATIC, AUTOMAT/REMOTE et REMOTE SET);• de sortir des pages de fixation des paramètres sans modifier les paramètres.
9	[▲/▼]	Boutons servant à modifier les valeurs dans les pages de fixation des paramètres.

Tableau Dorsal du Sublimation Controller

La figure suivante indique les commandes et les connexions du tableau dorsal du Sublimation Controller.

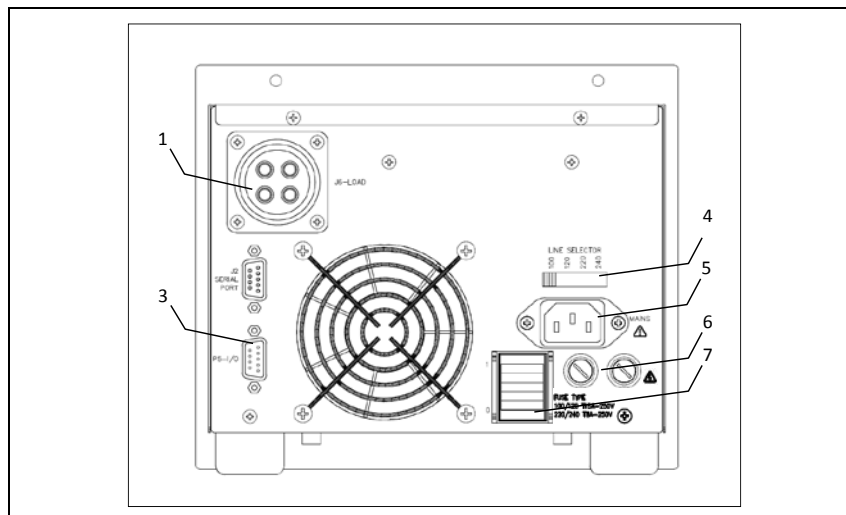

Figure 4 Tableau Dorsal du Sublimation Controller

- | | |
|---|--|
| 1 | Connecteur pour branchement câble pompe |
| 2 | Connecteur RS 232-485 |
| 3 | Connecteur de signaux d'E/S |
| 4 | Sélecteur tension réseau |
| 5 | Connecteur d'alimentation |
| 6 | Fusibles de protection |
| 7 | Interrupteur d'alimentation: allumé (I), coupé (O) |

Procédures d'Utilisation

Modes de Fonctionnement

Le Sublimation Controller peut fonctionner dans les modes **MANUAL**, **AUTOMATIC**, **REMOTE SET** et **AUTOMAT /REMOTE**. Dans les modes **MANUAL** et **AUTOMATIC**, toutes les commandes sont données par tableau frontal.

Dans les modes de fonctionnement **AUTOMAT/REMOTE** et **REMOTE SET**, les commandes sont données soit par des signaux sur le câble d'E/S soit par le tableau frontal.

NOTE

Après une coupure d'alimentation, le Sublimation retourne toujours au dernier mode de fonctionnement établi. Si le paramètre "AUTOSTART" a été établi sur "YES" et si une sublimation était à ce moment-là en cours, cette dernière reprendra automatiquement.

L'unité est conçue pour fonctionner dans deux modes différents:

- avec la sélection manuelle des paramètres (**MANUAL** et **REMOTE SET**)
- avec la sélection automatique des paramètres (**AUTOMATIC** et **AUTOMAT/REMOTE**).

Le Sublimation Controller peut être utilisé pour commander les pompes du type TSP ou bien du type Mini Ti-Ball.

Dans les modes **MANUAL** et **REMOTE SET**, la sélection des paramètres de la sublimation est effectuée directement par l'opérateur, au travers des commandes du tableau frontal (mode **MANUAL**) ou bien ils sont envoyés sur le connecteur d'E/S (mode **REMOTE**).

Si le Sublimation Controller doit être utilisé en association avec des pompes du type TSP, il faut sélectionner le type de source TSP. Si le contrôleur doit être utilisé en association avec des pompes du type Mini Ti-Ball, il faut sélectionner le type de source Mini Ti-Ball.

NOTE

L'unité est prééquipée en usine de la façon suivante:

- mode de fonctionnement MANUAL
- type de source TSP
- courant de sublimation: 30 A
- temps de sublimation: 1 minute
- période de sublimation: 3 minutes
- niveau de pression: 1×10^{-7} mbar
- "AUTOSTART" sur YES (redémarrage automatique de la sublimation après une coupure d'alimentation)

Des renseignements plus détaillés sur le mode de fonctionnement sont contenus dans l'appendice "Technical Information".

Mise sous Tension du Sublimation Controller

Pour mettre le Sublimation Controller sous tension, il suffit de mettre l'interrupteur d'alimentation situé sur le tableau dorsal dans la position "1".

Pour procéder ensuite à la sublimation, il suffit d'appuyer sur l'interrupteur "SUBLIMATION" se trouvant sur le tableau frontal puis sur ▲ ou ▼ pour changer le mode d'affichage en :

S	U	B	L	I	M	A	T	I	O	N					
◆	S	T	A	R	T		?		Y	E	S		M	A	N

Appuyer sur la touche SET pour lancer le processus de sublimation.

NOTE

Tant que la séquence susmentionnée n'a pas été achevée, le processus de sublimation ne peut être lancé et l'unité attend que les paramètres soient configurés.

Mise Hors Tension du Sublimation Controller

Pour mettre le Sublimation Controller hors tension, procéder comme suit:

- 1 presser l'interrupteur "SUBLIMATION" du tableau frontal (voyant bleu éteint)
- 2 mettre l'interrupteur d'alimentation du tableau frontal dans la position "O".

Entretien

Le Sublimation Controller n'exige aucun entretien. Toute opération doit être effectuée par un personnel agréé.

En cas de panne, il est possible de s'adresser au Service de réparation Agilent ou bien au "Agilent advance exchange service" qui permet d'obtenir un contrôleur neuf à la place du contrôleur détraqué.

AVERTISSEMENT!



Avant d'effectuer toute opération sur le contrôleur, débrancher le câble d'alimentation. En cas de panne, il est possible de s'adresser au Service de réparation Agilent ou bien au "Agilent advance exchange service" qui permet d'obtenir un contrôleur neuf à la place du contrôleur détraqué.

En cas de mise au rebut du contrôleur, procéder à son élimination conformément aux réglementations nationales en la matière.

Mise au Rebut

Signification du logo "WEEE" figurant sur les étiquettes.

Le symbole ci-dessous est appliqué conformément à la directive CE nommée "WEEE".

Ce symbole (**uniquement valide pour les pays de la Communauté européenne**) indique que le produit sur lequel il est appliqué NE doit PAS être mis au rebut avec les ordures ménagères ou les déchets industriels ordinaires, mais passer par un système de collecte sélective. Après avoir vérifié les termes et conditions du contrat de vente, l'utilisateur final est donc prié de contacter le fournisseur du dispositif, maison mère ou revendeur, pour mettre en œuvre le processus de collecte et mise au rebut.



Messages d'erreur

Dans certains cas de panne, le contrôleur procède à un autodiagnostic et affiche l'un des messages indiqués dans le tableau ci-dessous:

Tab. 2

Message	Description	Intervention
Power AC fail	Fréquence puissance réseau incorrecte.	Éteindre l'appareil et contrôler la puissance du réseau et que le sélecteur de tension ait été placé sur la valeur adéquate.
Heater defective	Le Mini Ti-Ball est déchargé. Le processus de sublimation a été arrêté.	Remplacer le Mini Ti- Ball.
Filamet x defective	Filament X où X peut être 1, 2 ou 3, interruption (= filament déchargé) durant un cycle de sublimation avec source TSP et paramètre "TSP RECOVER" sur "MANUAL". Le processus de sublimation a été arrêté.	Choisir manuellement un autre filament non déchargé ou configurer le paramètre "TSP RECOVER" sur "AUTOMATIC" ; ainsi, lorsqu'un filament sera déchargé, le logiciel sélectionnera automatiquement l'un des filaments restants et le voyant s'y rattachant s'allumera tandis que celui du filament défectueux se mettra à clignoter.
Cartridge defective	Tous les filaments TSP sont déchargés. Le processus de sublimation a été arrêté.	Remplacer la cartouche.
Fault: over-temperature	Température interne du contrôleur excessive. La température ambiante est trop élevée ou une surcharge interne s'est produite. Le processus de sublimation a été arrêté.	Contrôler la charge (pompe et câble) et éliminer la cause de la surcharge. Réduire la température ambiante.
External Interlock	L'interrupteur n'a pas été branché.	Brancher l'interrupteur : la broche 3 sur le connecteur E/S doit être reliée à l'une des broches communes (broche 6, 7, 8 ou 9). Il est également possible de brancher le connecteur d'accouplement fourni avec l'appareil.

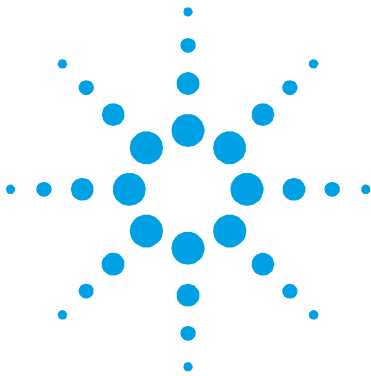

4 Instructions for Use

General Information	60
Controller Description	61
Storage	62
Preparation for Installation	63
Installation	65
Use	66
Sublimation Controller Front Panel Controls and Indicators	71
Sublimation Controller Rear Panel	69
Operating Procedures	70
Operating Modes	70
Sublimation Controller Switching ON	71
Sublimation Controller Switching OFF	72
Maintenance	72
Disposal	73
Error Messages	74

Original Instructions



General Information

This equipment is destined for use by professionals. The user should read this instruction manual and any other additional information supplied by Agilent before operating the equipment. Agilent will not be held responsible for any events occurring due to non-compliance, even partial, with these instructions, improper use by untrained persons, non-authorized interference with the equipment or any action contrary to that provided for by specific national standards.

The following paragraphs contain all the information necessary to guarantee the safety of the operator when using the equipment. Detailed information is supplied in the appendix "Technical Information".

This manual uses the following standard protocol:

CAUTION!

The caution messages are displayed before procedures which, if not followed, could cause damage to the equipment.

WARNING!



The warning messages are for attracting the attention of the operator to a particular procedure or practice which, if not followed correctly, could lead to serious injury.

NOTE

The notes contain important information taken from the text.

Controller Description

Agilent's Sublimation Controller is a titanium sublimation pumps (TSP) controller. The unit can be factory configured to the customer's needs, but the configuration can be modified by the user to adapt the controller to the different user needs.

Tab. 1

Description	Part number
Base Unit	
Sublimation Controller set for 220 Vac input voltage	929-0033
Sublimation Controller set for 110 Vac input voltage	929-0032
Accessories	
Cable for TSP pump	924-0730
Cable for Mini Ti-Ball pump	924-0752

The Sublimation Controller can control a TSP or a Mini Ti-Ball pump type.

The Sublimation Controller can be operated in different ways: MANUAL, AUTOMATIC, AUTOMAT/REMOTE and REMOTE SET. In MANUAL and AUTOMATIC modes all controls are given on front panel. In REMOTE SET and AUTOMAT/REMOTE some controls are given on front panel and others are given by signal through the I/O connector.

4 Instructions for Use

Storage

Storage

When transporting and storing the controller, the following environmental requirements should not be exceeded:

- temperature: from -20 °C to +70 °C
- relative humidity: 0 – 95 % (non-condensing)

Preparation for Installation

The Sublimation Controller is supplied in a special protective packing; If this shows signs of damage which may have occurred during transport, contact your local sales office.

When unpacking the controller, be sure not to drop it and avoid any kind of sudden impact or shock vibration to it.

Do not dispose of the packing materials in an unauthorized manner. The material is 100 % recyclable and complies with EEC Directive 94/62/CE and subsequent amendments.

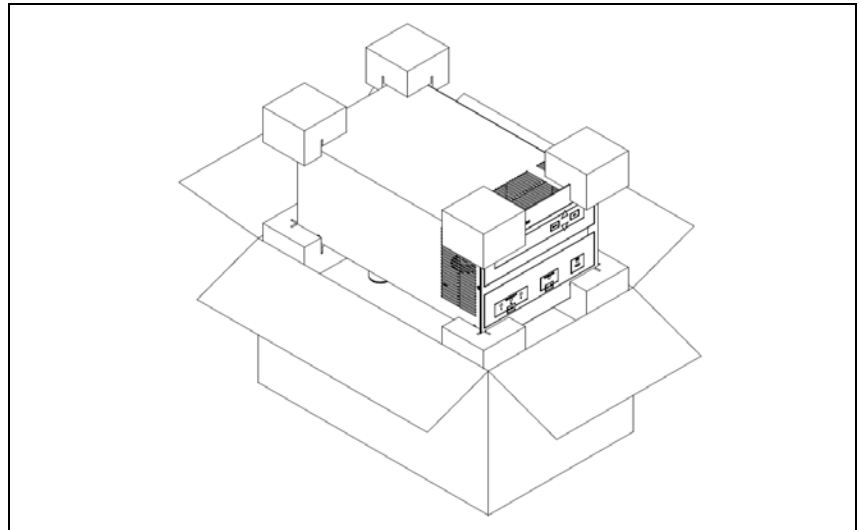

Figure 1 Controller Packaging

The Sublimation Controller is factory set for follows input voltages:

- model 929-0033 set to 220 Vac (input voltage 190 to 230 Vac).
- model 929-0032 set to 120 Vac (input voltage 110 to 130 Vac).

If a change in line voltage operation is desired, proceed as follows;

4 Instructions for Use

Preparation for Installation

- 1 Switch off the Sublimation Controller and unplug the power cord from the controller.
- 2 On the rear panel slide the voltage selector till the desired position.

CAUTION!

If the line voltage pass from 220-240 Vac to 100-120 Vac, or viceversa, the power cord and the fuses **MUST** be changed also. For 220-240 Vac the fuses must be T8A and for 100-120 Vac must be T15A.

- 3 If necessary, change the fuses and the power cord. If power cord must be changed, rewire as follows:
 - blue = neutral
 - brown = phase
 - yellow-green = ground
- 4 Plug the power cord to the controller

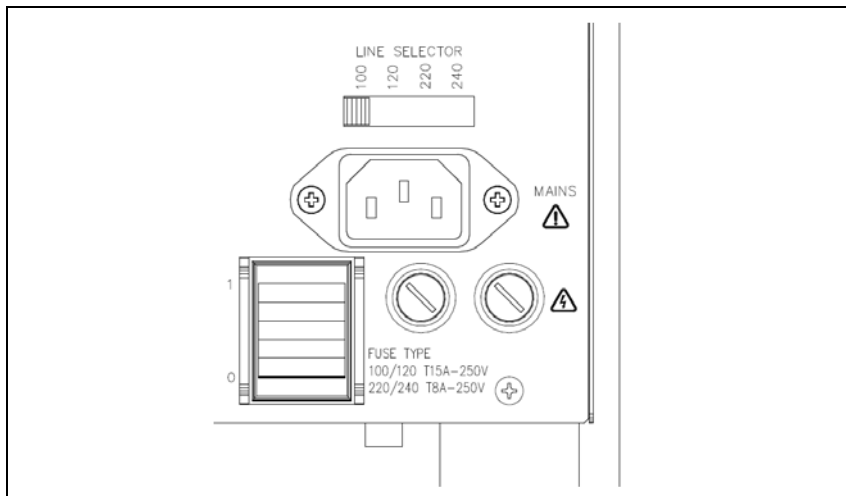

Figure 2 Rating voltage selector

Installation

WARNING!



The Sublimation Controller is equipped with a 3-wire power cord and plug (internationally approved) for user's safety. Use this power cord and plug in conjunction with a properly grounded power socket to avoid electrical shock. Verify that the ground connections are properly connected. High voltages developed inside the controller can cause severe injury or death. Before servicing the unit, disconnect the input power cable.

CAUTION!

The controller can be used as a bench unit or a rack module, but it must be positioned so that free air can flow through the holes of the top and side cover. If the Sublimation Controller is used as a rack module, it **MUST** be inserted in a 4 unit height rack adapter chassis to avoid collapse of the controller fall inside the rack. The front panel of the Sublimation Controller is not designed to support the controller weight. Do not install or use the Sublimation Controller in an environment exposed to atmospheric agents (rain, snow, ice), dust, corrosive gases or in explosive environments or those with a high fire risk.

NOTE

If the Sublimation Controller is used as a bench unit, it must have the four side legs. If the Sublimation Controller is installed on a rack, remove the four side legs and position it with at least 30 mm (1,2 inches) of clearance on top and bottom.

During operation, the following environmental conditions must be respected:

- temperature: from +0 °C to +45 °C
- relative humidity: 0 – 90 % (non-condensing)

To connect the Sublimation Controller to the pump use the specific cable supplied as an option. See the appendix “Technical Information” for detailed information about the above mentioned and other connection and about the optional card installation.

CAUTION!

The pump cable must be always completely unrolled before switching on the Sublimation.

4 Instructions for Use

Use

Use

This paragraph describes the fundamental operating procedures. Detailed information and operating procedures that involve optional connections or options are supplied in the paragraph “USE” of the appendix “Technical Information”.

Make all electrical connections of the controller and the pump prior to operating the controller. Read carefully the pump instruction manual prior to operating the system.

WARNING!



To avoid injury to personnel and damage to the equipment, if the pump is laying on a table make sure it is secure. Never operate the pump if the pump inlet is not connected to the system or blanked off.

Sublimation Controller Front Panel Controls and Indicators

The Sublimation Controller front panel is shown in the following figure. The control and indicator meanings and functions are detailed in the following table.

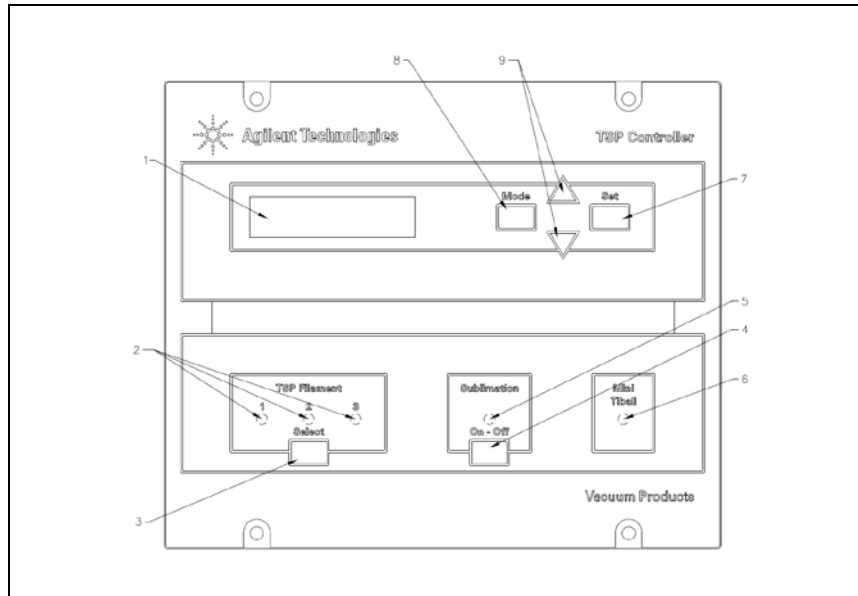

Figure 3 Sublimation Controller front panel controls

Ref.	Control/Indicator Name	Control/Indicator Description
1		LCD back lighted alphanumeric display dot matrix, 16 characters, 2 rows.
2	TSP FILAMENT 1, 2, 3	Blue LEDs that show: <ul style="list-style-type: none"> • if ON, the relevant TSP pump filament selected; • if blinking, the relevant TSP pump filament interrupted.
3	SELECT	Key for manual selection of one TSP pump filaments.

4 Instructions for Use

Use

Ref.	Control/Indicator Name	Control/Indicator Description
4	ON/OFF	Key for controller operating mode selection: <ul style="list-style-type: none">• OFF when “Parameters Setting” mode is activated;• ON when “Sublimation” is activated.
5	SUBLIMATION	Blue LED that show: <ul style="list-style-type: none">• if ON, that controller status is in waiting time between two sublimation or during current leading edge;• if blinking, the sublimation is in phase.
6	MINI TIBALL	Blue LED ON when Mini Ti-Ball operating mode is selected.
7	SET	Key that, depending on context: <ul style="list-style-type: none">• confirm the start of sublimation;• memorize the selection made;• reset a fail status.
8	MODE	Key that, depending on context: <ul style="list-style-type: none">• select the operating mode (MANUAL, AUTOMATIC, AUTOMAT/REMOTE and REMOTE SET);• escape from the parameters setting pages without changing the parameters.
9	[▼ / ▲]	Keys used to modify the values in the parameters setting pages.

Sublimation Controller Rear Panel

The following figure shows the controls and the connections of the Sublimation Controller rear panel.

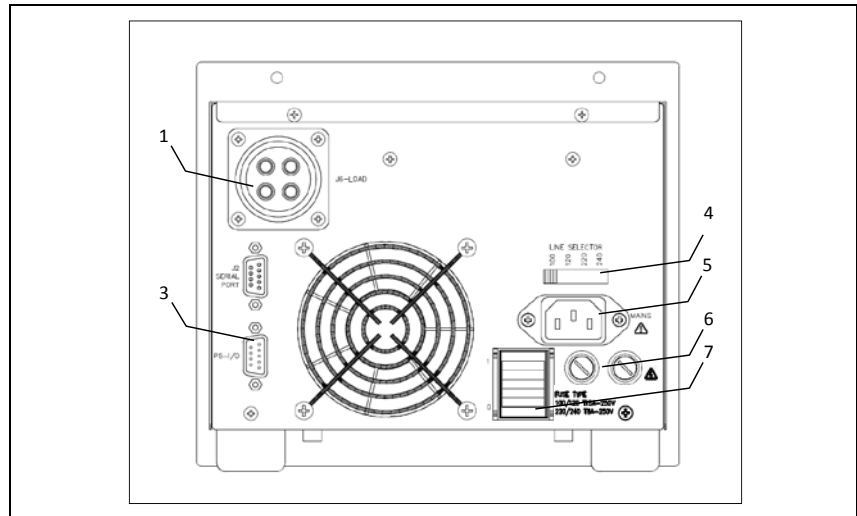

Figure 4 Sublimation Controller rear panel

- | | |
|---|----------------------------------|
| 1 | Connector to plug the pump cable |
| 2 | RS 232-485 connector |
| 3 | I/O signals connector |
| 4 | Line voltage selector |
| 5 | Power cord socket |
| 6 | Protection fuses |
| 7 | Power switch: ON (I)/OFF(O) |

Operating Procedures

Operating Modes

The Sublimation Controller can be operated in the **MANUAL**, **AUTOMATIC**, **REMOTE SET** and **AUTOMAT/REMOTE** mode.

In **MANUAL** and **AUTOMATIC** modes all the controls are given on front panel.

In **AUTOMAT/REMOTE** and **REMOTE SET**, the controls are given via signals coming through the I/O cable.

NOTE

After a power failure the Sublimation Controller will return to the previously selected operating mode. If "AUTOSTART" parameter was set on "YES" and before the power failure the unit was in sublimation mode, the sublimation starts on again automatically.

The unit is designed to operate in two different modes:

- with manual selection of the parameters (**MANUAL** and **REMOTE SET** modes)
- with automatic selection of the parameters (**AUTOMATIC** and **AUTOMAT/REMOTE** modes)

The Sublimation Controller can be used to control the TSP or Mini Ti-Ball pumps type.

In **MANUAL** and **REMOTE SET** operating modes the sublimation parameters are setting by the user by means of the front panel controls (**MANUAL** mode) and/or by signal send on the I/O connector (**REMOTE** mode).

If the Sublimation Controller is used in conjunction with the TSP pump the TSP source type must be set. If the Sublimation Controller is used in conjunction with the Mini Ti-Ball pump the Mini Ti-Ball source type must be set.

NOTE

The unit is factory set as follows:

- MANUAL operating mode
- TSP source type
- sublimation current 30 A
- sublimation time 1 minute
- sublimation period 3 minutes
- pressure threshold 1×10^{-7} mbar
- "AUTOSTART" on "YES" (automatic restart before power failure)

Detailed information about the operating modes are contained in the appendix "Technical Information".

Sublimation Controller Switching ON

To switch ON the Sublimation Controller switch the power switch located on the rear panel to the "1" position.

To start the sublimation, push the "SUBLIMATION" key located on the front panel then press ▲ or ▼ to change the display to:

S	U	B	L	I	M	A	T	I	O	N					
◆	S	T	A	R	T		?		Y	E	S		M	A	N

Press **SET** key to start the sublimation.

NOTE

Until the above sequence is not concluded, the sublimation will not start and the unit will wait for a parameters setting.

Sublimation Controller Switching OFF

To switch OFF the Sublimation Controller , proceed as follows:

- 1 push the “SUBLIMATION” key located on the front panel (blue LED extinguished)
- 2 switch the power switch located on the rear panel to the “O” position.

Maintenance

The Sublimation Controller does not require any maintenance. Any work performed on the unit must be carried out by authorized personnel.

WARNING!



Before carrying out any work on the controller, disconnect it from the supply. In the case of breakdown, contact your local Agilent service center who can supply a replacement controller.

If a controller is to be scrapped, it must be disposed of in accordance with the specific national standards.

Disposal

Meaning of the "WEEE" logo found in labels

The following symbol is applied in accordance with the EC WEEE (Waste Electrical and Electronic Equipment) Directive.

This symbol (**valid only in countries of the European Community**) indicates that the product it applies to must NOT be disposed of together with ordinary domestic or industrial waste but must be sent to a differentiated waste collection system.

The end user is therefore invited to contact the supplier of the device, whether the Parent Company or a retailer, to initiate the collection and disposal process after checking the contractual terms and conditions of sale.



Error Messages

For a certain type of failure, the controller will self-diagnose the error and the messages described in the following table will be displayed.

Tab. 2

Message	Description	Repair Action
Power AC fail	Incorrect mains power frequency.	Switch OFF the unit then check the mains power and the correct setting of the voltage selector.
Heater defective	The Mini Ti-Ball is exhaust. The sublimation is turned off.	Replace the Mini Ti-Ball.
Filament x defective	Filament X, where X can be 1, 2 or 3, interruption (= filament exhaust) during a sublimation cycle with source type TSP and the "TSP RECOVER" parameter set in "MANUAL". The sublimation will turn off.	Select manually another filament not exhaust or set the "TSP RECOVER" parameter to "AUTOMATIC"; in this configuration when a filament becomes exhaust, the software selects automatically one of the remaining filaments and the relevant LED will be ON. The led related to the filament detected defective starts to blink.
Cartridge defective	All TSP filaments are exhaust. The sublimation is turned off.	Replace the TSP cartridge.
Fault: overtemperature	Controller internal over-temperature. The ambient temperature is too high or an external overload occurs: the sublimation is turned off.	Check the load (pump and cable) and eliminate the cause of the overload. Reduce the ambient temperature.
External interlock	The interlock is not connected.	Connect the interlock: the pin 3 on the I/O connector must be shorted to one of the Common pins (pin 6, 7, 8 or 9). It is also possible to plug the mating connector supplied with the controller.

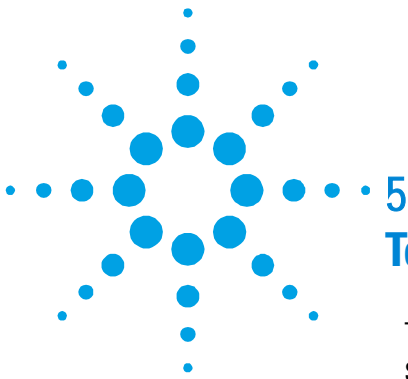

5 Technical Information

Technical Information	75
Sublimation Controller Description	77
Sublimation Controller Specification	79
Sublimation Controller Outline	80
Pump Connection (J6 connector)	81
Remote I/O Connection (P5 connector)	82
Serial Port (J2 connector)	83
Serial Cable Installation	84
Use	86
Sublimation Controller Configuration	86
Operating Mode Selection	93
Sublimation Parameters Setting	95
Parameters Values	99
Sublimation	99
Operation in MANUAL Mode	101
Operation in AUTOMATIC Mode	102
Operation in REMOTE SET Mode	102
Operation in AUTOMAT/REMOTE Mode	103
Sublimation Timing	103
Operational Flow-Chart	103
Front Panel Leds Meaning	105
Serial Communication Protocol	106
Serial Communication Protocol	106

5 **Technical Information**

Error Messages

Letter Protocol Description	107
Communication Format	107
Communication Protocol	107
Example of TSP Messages	112
Window Protocol Description	113
Window-Meanings	118
Orderable parts	121

Original Instructions

Sublimation Controller Description

The Sublimation Controller base is available in two versions which differ only in the factory set input voltage.

- Model 929-0032 set for 120 Vac 60 Hz
- Model 929-0033 set for 220 Vac 50 Hz

The models are provided with a front panel with an LCD alphanumeric display to indicate the operating conditions/parameters of the Sublimation pump, a keyboard and a rear panel with input/output connectors.

The following figure shows the controller outward appearance.

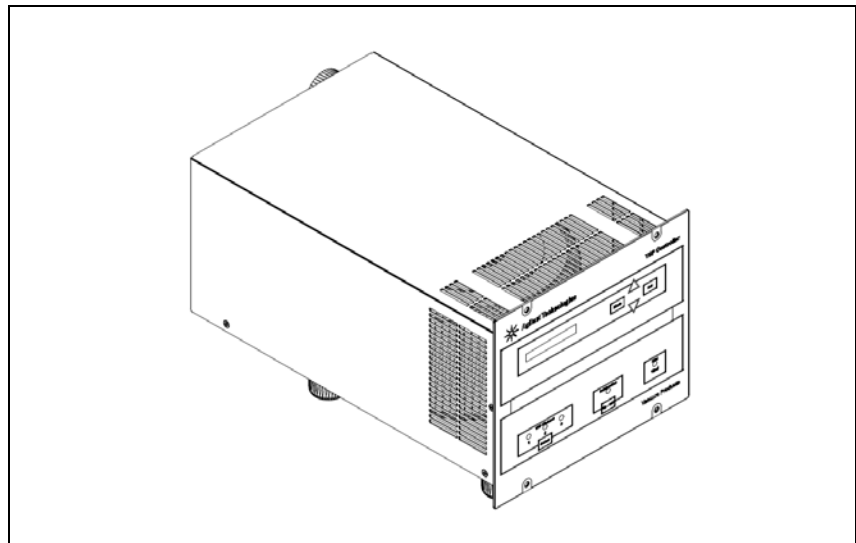

Figure 5 Sublimation Controller

The controller is a solid-state voltage converter which is driven by a single chip Microcontroller and is composed of two PCBs which include output power, analog and digital input/output section, microcontroller and digital sections.

5 Technical Information

Sublimation Controller Description

The controller converts mains voltage supply into a single-phase, low voltage, high current output which is required to power the pump.

The controller can be operated by a remote hostcomputer via the serial connection.

The microcontroller generates the variable output current and controls it according to the user settings and the pump status (cartridge depletion).

Moreover, it manages the signals from input/output connections, the information to be displayed, and gives outputs for a fully automatic operation.

An EEPROM internal to the microcontroller is used to store pump operating parameters and the input/output programmed information.

The controller can be operated via:

- front panel switches;
- RS 232 and RS 485 serial link.

Sublimation Controller Specification

Tab. 3

Input:	
• Voltage: (selectable at the rear of the case)	100, 120, 220, 240 Vac \pm 10% 1-phase • 90 to 110 Vac - 1 phase (use setting 100 Vac) • 110 to 130 Vac - 1 phase (use setting 120 Vac) • 190 to 230 Vac - 1 phase (use setting 220 Vac) • 230 to 265 Vac - 1 phase (use setting 240 Vac)
• Frequency:	47 to 63 Hz
• Power:	1400 VA (maximum, see note)
• Fuse:	2 x T15A (slow blow) 250V 5x20 fuses (only for model 929-0032) 2 x T8A (slow blow) 250V 5x20 fuses (only for model 929-0033)
Operating:	
• Temperature	0 to + 45 °C
• Humidity	90 % maximum non condensing humidity
Storage temperature	-20 °C to +70°C
In compliance with norms	EN 61010-1 (2001) EN 61326-1 (2006) - Class A (industrial application)
Protection category	IP 20
Internal use only	
Installation category	II
Pollution degree	2
Power cable	3 meters long • 3 wires \varnothing AWG14, NEMA plug (only for model 929-0032) • 3 wires \varnothing 0.75 mm ² European plug (only for model 929-0033)
Weight	12 Kg (26.5 lbs)

NOTE

When the controller is powered by means of a transformer, the transformer power must be at least 3000 VA to avoid a distortion of the power waveform.

Sublimation Controller Outline

The outline dimensions for the Sublimation Controller base unit are shown in the following figure.

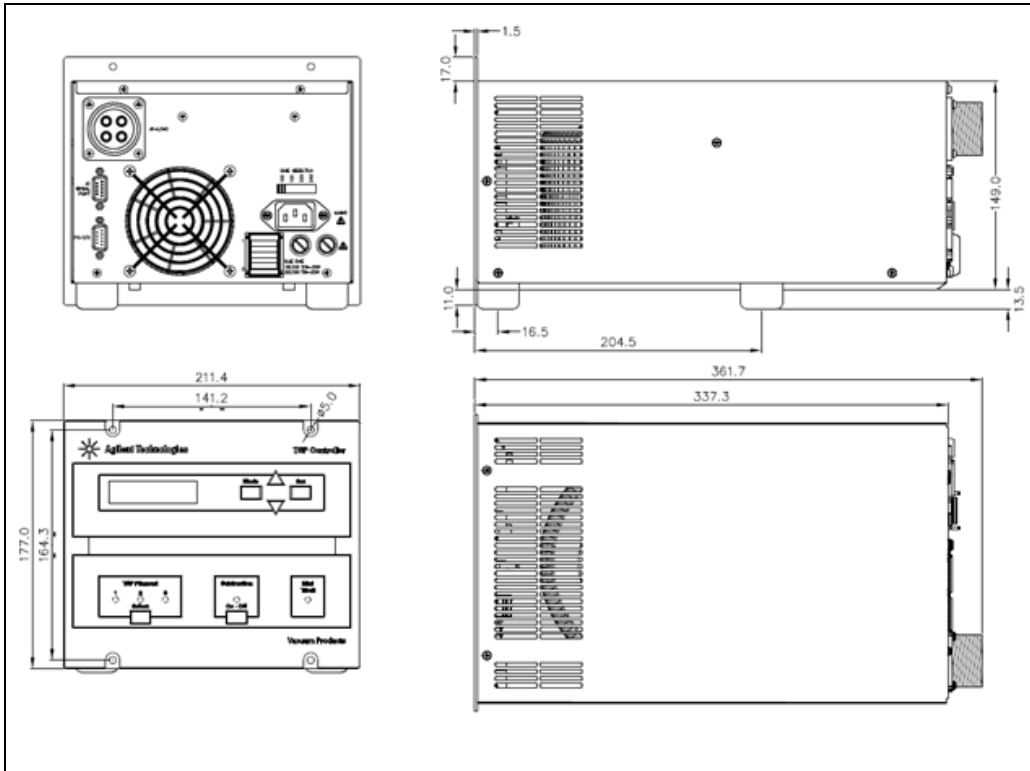

Figure 6 Sublimation Controller outline

NOTE

Leave at least 30 mm (1.2 inches) of free air circulation on top and bottom of the unit for an efficient cooling of the unit. Blind the unused slots on rear panel with the provided covers.

Controller Interconnections

Pump Connection (J6 connector)

The pump is connected to the controller rear panel via “LOAD” connector (cable to be separately ordered).

WARNING!

When installing the high power cable:



- 1 Turn the power off.
- 3 Plug the cable on the pump side and secure it with the ring nut.
- 4 Plug the cable on the controller side and secure it with the ring nut.

Before removing the cable make sure that the power is off.

Remote I/O Connection (P5 connector)

An external analogue unit can be connected to the I/O connector to set some sublimation parameters and receive feedback from the field.

It is a 9-pins Male D type connector. The pin layout is shown in the following figure.

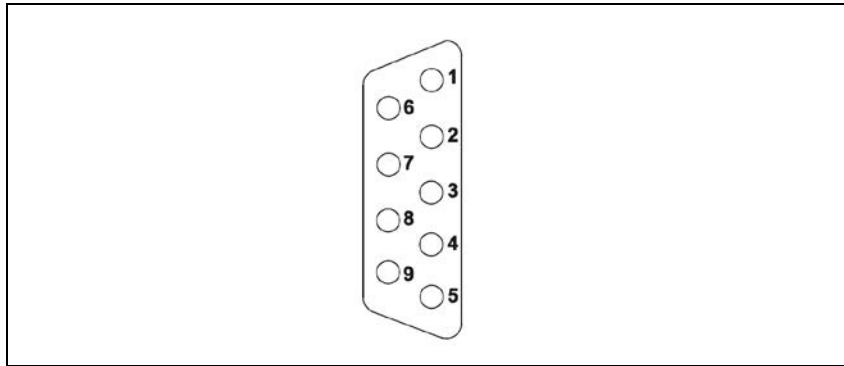

Figure 7 I/O connector layout

The correspondence between pin and signal is:

- Pin 1 Input signal. Voltage range 0 to 10 Vdc. Used for setting sublimation current value between 30 A (corresponding to 6 Vdc) and 50 A (corresponding to 10 Vdc).
- Pin 2 Input signal. Voltage range 0 to 5 Vdc. Used for setting pressure threshold value: minimum value $1 \cdot 10^{-10}$ mbar (corresponding to 0 Vdc), maximum value $1 \cdot 10^{-4}$ mbar (corresponding to 5 Vdc).
- Pin 3 Interlock. This pin must be shorted to one of the common pins (number 4 or 6 to 9) (the jumper is furnished with the controller).
- Pin 4 Not Connected
- Pin 5 Output signal. Voltage range 0 to 10 Vdc. Used to feedback the sublimation current value applied during sublimation (0 Vdc = 0 A, 10 Vdc = 50 A).
- Pin 6 to 9. Common.

NOTE

Without the interlock connection the controller cannot operate. If the controller is not connected with a remote unit the tap furnished with the controller must be used. If the controller is connected with a remote unit the interlock must be correctly connected as described.

Serial Port (J2 connector)

This is a 9 pin Female D-type serial input/output connector to control via an RS 232 or RS 485 connection the Sublimation Controller. The pin layout is shown in the following figure.

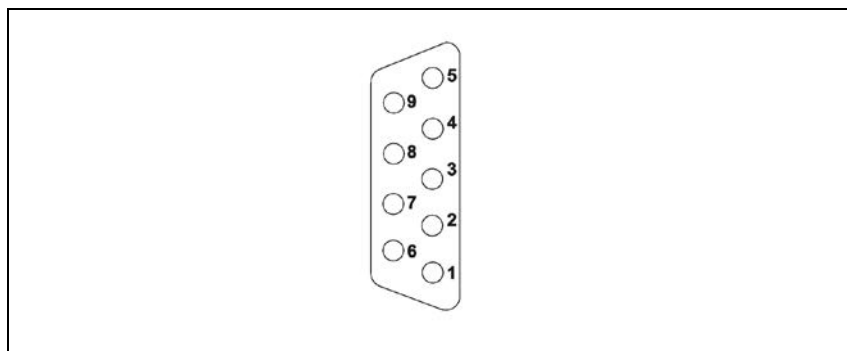

Figure 8 I/ O connector layout

Pin	Signal
1	Not connected
2	TX (RS232)
3	RX (RS232)
4	Not connected
5	GND
6	A + (RS485)
7	Not connected
8	B – (RS485)
9	Not connected

Serial Cable Installation

A serial cable must be installed when the Sublimation Controller has to be controlled by means of a remote personal computer.

The cable is installed fixing the 9 pin D-type Male connector into the J2 serial port connector.

Serial connection examples:

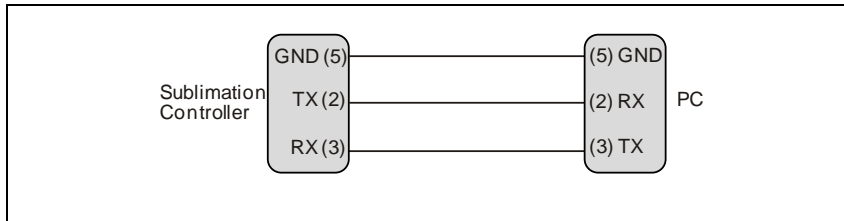

Figure 9 RS-232 Connection

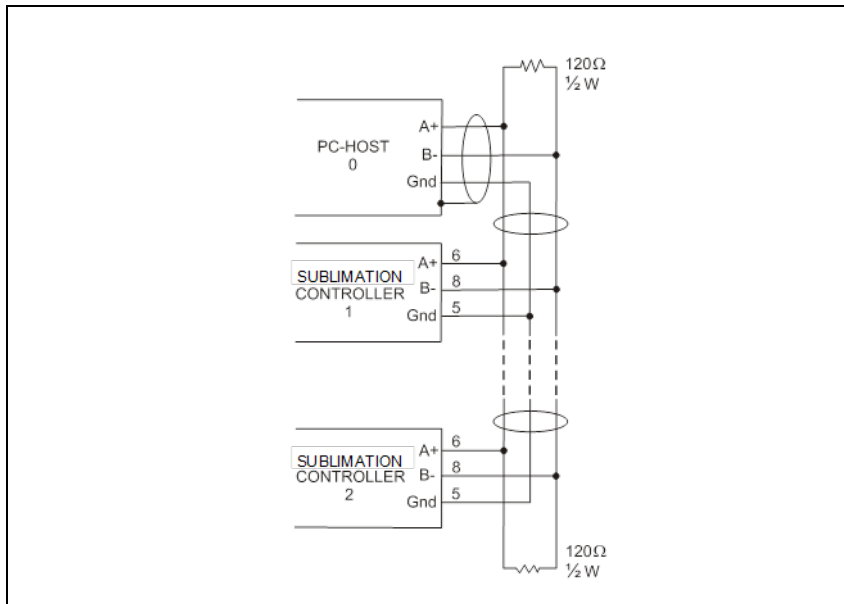

Figure 10 RS-485 Connection

The communication port mating connector is supplied with the unit. See the host computer's instruction manual for further details on serial port connections.

The following picture shows the right procedure to connect a cable to the I/O or to the serial port connector. A shielded cable of 30 m maximum length has to be utilized for both serial and I/O port connections.

NOTE

Take care to have a good contact (soldered) between the metallic connector case and the external shield of the cable. Moreover, this connection has to be assured at least on the controller side.

In this way, you will be sure to reduce the influence of the external noise and to accomplish the EMC requests.

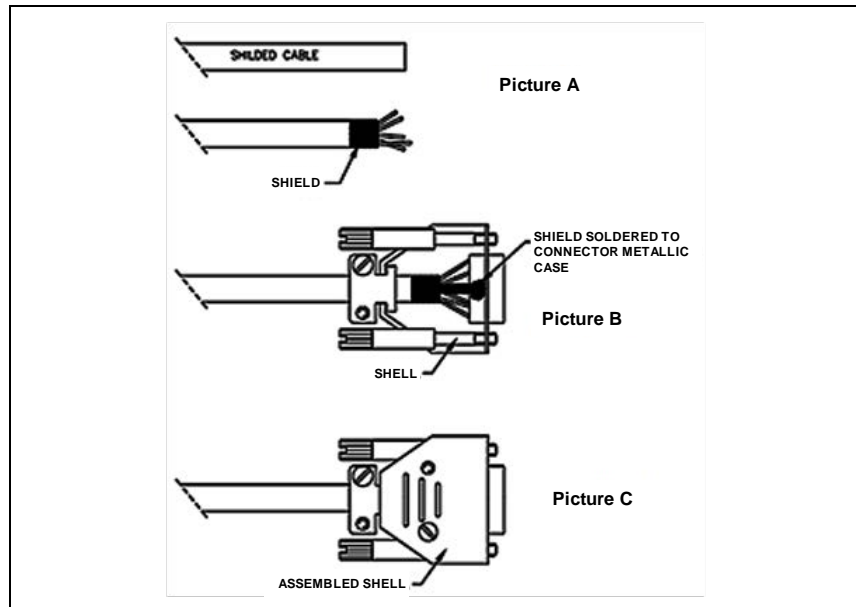

Figure 11 Cable assembling instruction

Use

There are three different type of settings that can be selected:

- 1 configuration of the Sublimation Controller
- 2 operating mode selection
- 3 parameters settings.

NOTE

The unit is factory set for:

- MANUAL mode operation
- source TSP
- sublimation current 30 A
- sublimation time 1 minute
- sublimation period 3 minutes
- pressure threshold 1×10^{-7} mbar
- "AUTOSTART" set YES (automatic restart after shut down)

Sublimation Controller Configuration

This menu allows to set the following parameters:

- the pump cable resistance;
- the type of source (TSP or Mini Ti-Ball™ cartridge) powered by the Sublimation Controller.

To enable the Sublimation Controller Configuration menu press and hold the **MODE** and **SET** keys on the front panel and simultaneously, on rear panel, switch on the power.

NOTE

At the first Power ON cycle, the Sublimation Controller enters automatically in the Sublimation Controller Configuration menu.

The display shows:

C	O	N	F	I	G	:									
		S	E	L	E	C	T		C	A	B	L	E		

Press **SET** to enter in the choice menu.

The display shows one of the following messages, depending on the actual configuration stored in the unit:

		S	E	L	E	C	T		C	A	B	L	E		
		C	A	B	L	E		A	W	G		6			

or:

		S	E	L	E	C	T		C	A	B	L	E		
		C	A	B	L	E		A	W	G		8			

or:

		S	E	L	E	C	T		C	A	B	L	E		
		C	U	S	T	O	M								

Press **▲** or **▼** to change the cable type from AWG 6 cross section, AWG 8 cross section and CUSTOM cable.

Press **SET** to confirm the choice.

5 Technical Information

Use

NOTE

In any configuration menu it is possible to come back at the upper menu, without storing any modifications, by pressing the **MODE** key.

Selecting the options AWG 6 or AWG 8, the unit shows:

S	E	L	E	C	T		L	E	N		C	A	B	L	E
							3		m						

Press ▲ or ▼ to set the pump cable length from 3 to 50 m, then press **SET** to confirm the choice.

Selecting the option CUSTOM, the unit shows:

S	E	L	E	C	T		R	E	S		C	A	B	L	E
						1	2		m	O	h	m			

Press ▲ or ▼ to set the total pump cable Electrical Resistance at 20°C (R_{cable}) from 12 to 250 mΩ;

$$R_{cable} = 2 * R_{PUL} * L_c$$

Where:

- R_{PUL} = single wire per-unit-length resistance [mΩ/m] @20°C
- L_c = pump cable length [m]

then press **SET** to confirm the choice.

NOTE

If the pump cable Electrical Resistance is more than 200 mΩ, the controller doesn't assure the full current (50A) to the load all over the range of supply voltage.

The display shows:

C	O	N	F	I	G	:									
		S	E	L	E	C	T		C	A	B	L	E		

Press ▲ or ▼ to select the Source Type option:

C	O	N	F	I	G	:									
		S	O	U	R	C	E		T	Y	P	E			

Then press **SET** to enter in the menu.
The display shows:

		S	O	U	R	C	E		T	Y	P	E			
						T	S	P							

Press ▲ or ▼ to to change the source type from TSP to Mini Ti-Ball, and the display shows:

		S	O	U	R	C	E		T	Y	P	E			
		M	i	n	i		T	i	-	b	a	l	l		

Press **SET** to confirm the choice.

The controller stores the setting and the display returns to show:

C	O	N	F	I	G	:									
		S	O	U	R	C	E		T	Y	P	E			

When the configuration is concluded press **MODE** to exit the Sublimation Controller Configuration menu. The controller passes to normal operations and performs the Autotest.

Normal operations

At the Power-ON the controller performs the Autotest. During the Autotest execution the display shows:

				A	U	T	O	T	E	S	T				

The software checks the presence of the zero-crossing signal and, in case of fault (frequency absent or different from 50 or 60 Hz), the display shows:

5 Technical Information

Use

	P	O	W	E	R		A	C		F	A	I	L		

The controller freezes and must be shut down.

If the check has a positive result, the display shows, for a few seconds:

				A	U	T	O	T	E	S	T				
							O	K							

Then the display shows one of the following messages, depending on the source type previously selected:

M	i	n	i		T	i	-	b	a	i	i				⬇
													M	A	N

or:

T	S	P		F	i	l	a	m	e	n	t		X		⬇
													M	A	N

Where X can be 1, 2 or 3 depending on the TSP filament selected. The message **MAN** that appears at the end of the second row indicates the Filament Recover setting active, between **MANUAL** and **AUTOMATIC** (the factory setting is **MANUAL**).

With the Filament Recover option set to **MANUAL**, in case of TSP filament exhaust, the controller doesn't switch automatically to another filament.

Use the Operating Mode Settings menu to modify the Filament Recover setting.

Operating Mode Settings

This menu allows to set the following parameters:

- Sublimation Autostart (enables/disables the automatic restart of sublimation after a shut down).
- Filament Recover: (enables/disables the automatic filament switch-over in consequence of a Filament Defective fail).

To enable the Operating Mode Settings menu press simultaneously the **MODE** and **SET** keys on the front panel.

NOTE

Before activating the configuration mode, make sure that the SUBLIMATION Led is off.

The display shows:

S	U	B	L	I	M	A	T	I	O	N					
◄	A	U	T	O	S	T	A	R	T	:		Y	E	S	

The AUTOSTART is factory set on YES. This enable the automatic restart of the sublimation after a shut down. Press ▲ or ▼ key to change from YES to NO and viceversa. The display shows:

S	U	B	L	I	M	A	T	I	O	N					
◄	A	U	T	O	S	T	A	R	T	:		N	O		

Make the selection then press **SET** key to confirm the choice.

If the controller is configured to supply a TSP source type (cartridge with multiple filament), the display will show:

T	S	P		R	E	C	O	V	E	R	:				
◄			A	U	T	O	M	A	T	I	C				

5 Technical Information

Use

The factory setting is AUTOMATIC, that enables the automatic change of the TSP filament in case of fault (if possible). This configuration can be changed on MANUAL by pressing the ▲ or ▼ key. In this case the display shows:

T	S	P		R	E	C	O	V	E	R	:				
◆					M	A	N	U	A	L					

In MANUAL configuration, in case of interruption of the TSP filament, the controller will be in a fault condition and the sublimation will be interrupted.

To confirm the choice press **SET** key. The display shows:

S	E	R	I	A	L		T	Y	P	E					
◆			R	S	2	3	2								

This configuration can be changed between RS232 and RS485 by pressing the ▲ or ▼ key.

To confirm the choice press **SET** key.

If has been selected the RS485 Serial Interface type (otherwise the display shows the next option), the display shows:

S	E	R	I	A	L		A	D	D	R	E	S	S		
◆						X	X	X							

Where **XXX** is the serial address currently set.

This configuration can be changed by pressing the ▲ or ▼ keys selecting a value from 0 to 31.

To confirm the choice press **SET** key.

The display shows:

S	E	R	I	A	L		B	A	U	D		R	A	T	E
◆		X	X	X	X		B	A	U	D					

Where **XXXX** is the speed of communication expressed in Baud.

This configuration can be changed by pressing the ▲ or ▼ keys selecting a value from the following values: 600, 1200, 2400, 4800, 9600, 19200, 38400.

To confirm the choice and close the menu press **SET** key.
The display returns to the previous message:

M	i	n	i		T	i	-	b	a	l	l				◆	
														M	A	N

or:

T	S	P		F	i	l	a	m	e	n	t		X		◆	
														M	A	N

Operating Mode Selection

To select the operating mode press the **MODE** key.
The display shows:

M	O	D	E	:												
◆				M	A	N	U	A	L							

In this operating mode the selection of time, period and current value of sublimation are set by means of the control panel.

If the ▲ key is pressed the display shows:

M	O	D	E	:												
◆				A	U	T	O	M	A	T	I	C				

5 Technical Information

Use

In this operating mode only the sublimation current value and the pressure threshold are set by means of the control panel. The sublimation occurs when the pressure threshold is reached (analog input on pin 2 of the I/O connector, range 0 to 5 Vdc).

If the ▼ key is pressed the display shows the previous message (mode MANUAL).

If the ▲ key is pressed the display shows:

M	O	D	E	:											
↕			R	E	M	O	T	E		S	E	T			

In this operating mode only the time and period of sublimation are set by means of the control panel. The current value of sublimation is set by means of a signal incoming on the analog input on pin 2 of the I/O connector, range 0 to 10 Vdc (0 Vdc = 0 A, 10 Vdc = 50 A).

If the ▼ key is pressed the display shows the previous message (mode AUTOMATIC).

If the ▲ key is pressed the display shows:

M	O	D	E	:											
↕	A	U	T	O	M	A	T	/	R	E	M	O	T	E	

In this operating mode the sublimation starts when the pressure threshold is reached (as in the AUTOMATIC operating mode).

The current value of sublimation is set by means of a signal incoming on the analog input on pin 2 of the I/O connector, range 0 to 10 Vdc.

If the ▼ key is pressed the display shows the previous message (mode REMOTE SET).

If the ▲ key is pressed the display shows the first message illustrated before (mode MANUAL).

To select the desired operating mode press the **SET** key. The controller comes back to the normal operating mode and the display shows one of the following messages, depending on the source type selected.

M	i	n	i		T	i	-	b	a	l	l				◆	
														M	A	N

or:

T	S	P		F	i	l	a	m	e	n	t		X		◆	
														M	A	N

The message **MAN** at the end of the second row can be different. It depends of the operating mode selected:

- in mode **AUTOMATIC** the message become **AUT**
- in mode **REMOTE SET** the message become **REM**
- in mode **AUTOMAT/REMOTE** the message become **A/M**.

NOTE

The controller escape automatically from the operating mode selection before 30 second, if no selection are made, and return to the normal operation. If the **MODE** key is pressed during the operating mode selection the Sublimation Controller returns to the normal operation and the operating mode remains that previously selected before the activation of the operating mode selection.

Sublimation Parameters Setting

The mode by means of which is possible to modify the sublimation parameters depends on the selected operating mode (**MANUAL**, **AUTOMATIC**, **REMOTE SET** and **AUTOMAT/REMOTE**). In the following paragraph are described the different setting for each operating mode. To display the sublimation parameters menu and to switch from one page to another, press the ▼ or ▲ keys.

5 Technical Information

Use

When the desired parameter is displayed, the value can be changed as follows:

- 1 press the **SET** key
- 2 press **▲** key to increase the value or **▼** key to decrease the value
- 3 press **SET** key to confirm the choice or **MODE** key to escape without changing the value. In any case the controller come back to the normal operating mode and the display shows one of the following messages, depending on the source type selected.

M	i	n	i		T	i	-	b	a	l	l				◆	
														M	A	N

or:

T	S	P		F	i	l	a	m	e	n	t		X		◆	
														M	A	N

The message **MAN** at the end of the second row can be different. It depends on the operating mode selected and changes as previously described.

NOTE

The controller escapes automatically from the sublimation parameters setting mode before 30 second, if no selection are made, and return to the normal operation.

NOTE

The sublimation current value can even be set when the sublimation is activated.

Selection in MANUAL Operating Mode

In this operating mode the possible selection on the front panel are:

- sublimation period
- sublimation time
- current value.

During the sublimation period setting the display shows:

S	U	B	L	.		P	E	R	I	O	D				↕	
		X	X		Y	Y	Y	Y	Y					M	A	N

Where **XX** is the value currently set and **YYYYY** is the unit used (minutes or hours).

The possible selectable values, by means of the ▼ or ▲ keys, range from 3 minutes to 32 hours (for intermediate values refer to “Parameters Values”). When the sublimation time setting is activated the display shows:

S	U	B	L	.		T	I	M	E							↕
				X	.	X		m	i	n				M	A	N

Where **X.X min** is the value currently set.

The possible selectable values, by means of the ▼ or ▲ keys, are comprised from 1 to 15 minutes, with step of 30 seconds.

NOTE

The software does not permit the setting of a sublimation time greater than period of sublimation.

For the current value of sublimation the display shows:

S	U	B	L	.		C	U	R	R	E	N	T				↕
				X	X	.	X		A					M	A	N

Where **XX.X A** is the currently set value.

The possible selectable values, by means of the ▼ or ▲ keys, are comprised from 30 to 50 A, with step of 0.5 A.

5 Technical Information

Use

Selection in AUTOMATIC Operating Mode

In this operating mode the possible selection on the front panel are:

- sublimation time
- sublimation current value
- pressure threshold.

For the time and current value the possible settings and the messages displayed are the same shown for the MANUAL operating mode, excepted for the script **AUT** in place of **MAN** at the end of the second row.

For the pressure threshold setting the display shows:

S	U	B	L	.		P	R	E	S	S	U	R	E		↕
	X	*1	0	X	X		m	b	a	r			A	U	T

Where $X*10^{-XX}$ is the pressure threshold set in mbar.

The possible selectable values, by means of the ▼ or ▲ keys, are comprised from $1*10^{-10}$ to $1*10^{-4}$ mbar, with step of $1*10^{-x}$ mbar.

Selection in REMOTE SET Operating Mode

In this operating mode the possible selection on the front panel are:

- sublimation time
- sublimation period.

For these parameters the possible settings and the messages displayed are the same shown for the MANUAL operating mode, excepted for the script **REM** in place of **MAN** at the end of the second row.

Selection in AUTOMAT/REMOTE Operating Mode

In this operating mode the possible selection on the front panel are:

- sublimation time
- pressure threshold.

For these parameters the possible settings and the messages displayed are the same shown for the MANUAL and AUTOMATIC operating mode, excepted for the script **A/R** in place of **MAN** at the end of the second row.

Parameters Values

In the following table are indicated the different possible values for each sublimation parameter.

Tab. 4

Parameter	Default value	Adjustable range
Current	30 A	30 A to 50 A at step of 0.5 A
Time	1 minute	1 minute to 7 minutes at step of 30 seconds
Period	3 minutes	CONTINUOUS or 3 minutes to 32 hours with following intermediate values: <ul style="list-style-type: none"> • 10 minutes • 30 minutes • 1 hour • 2 hours • 4 hours • 8 hours
Pressure threshold	1×10^{-7} mbar	1×10^{-10} mbar to 1×10^{-4} mbar at step of 1×10^{-x} mbar

Sublimation

To start the sublimation proceed as follows:

- 1 On the rear panel, turn the power switch on (I position).
- 2 Wait for the following messages displayed in sequence:

				A	U	T	O	T	E	S	T				

5 Technical Information

Use

				A	U	T	O	T	E	S	T				
							O	K							

M	i	n	i		T	i	-	b	a	i	i				↕
													M	A	N

or:

T	S	P		F	i	l	a	m	e	n	t		X		↕
													M	A	N

Then press the **SUBLIMATION** key. The relevant Led will be turned on and the display shows:

S	U	B	L	I	M	A	T	I	O	N					
↕	S	T	A	R	T		?		N	O			M	A	N

Pressing the ▼ or ▲ keys the display shows:

S	U	B	L	I	M	A	T	I	O	N					
↕	S	T	A	R	T		?		Y	E	S		M	A	N

Press **SET** key to confirm the start or any other key to escape. After the start time, during the current ramp the display shows:

V	=	X	X	.	X	V			I	=	X	X	.	X	A
C	U	R	R	.		R	A	M	P				M	A	N

Where **XX.X** are the currently value used.

Then, finish the current ramp, during the sublimation, the display shows the voltage, the current and the time used for the sublimation, as follows:

V	=	X	X	.	X	V			I	=	X	X	.	X	A
T	=	X	X	:	X	X	:	X	X				M	A	N

Where **XX.X** are the currently value used and **XX:XX:XX** is the sublimation time expressed in hours, minutes and seconds format.

Between sublimations, the display shows the remaining time before next sublimation and the period set for the sublimation, as follows:

T	I	M	E		T	O		S	U	B	L	=	X	X	h
P	E	R	I	O	D	=	X	X	h				M	A	N

Where **XX** are the current value.

The operation of the Sublimation Controller depends on the operating mode selected as described below.

Operation in MANUAL Mode

After the start confirmation (by press **SET** key at the message “SUBLIMATION START ? YES”) the sublimation begin with the parameters previously set or default until the **SUBLIMATION** key is pressed and the relevant green Led is turned off.

During a sublimation cycle it is possible to modify the current value. In this case press **SET** key and the display shows:

I	s	e	t		=		X	X	.	X		A			
													M	A	N

With the ▼ or ▲ keys increase or decrease the current value, then press **SET** key to confirm or any other key to escape without modifying the setting.

5 Technical Information

Use

NOTE

The Sublimation Controller escape automatically from the current setting before 30 second, if no selection are made, and return to sublimation operation.

Operation in AUTOMATIC Mode

After the start confirmation (by press **SET** key at the message “SUBLIMATION START ? YES”) the sublimation begin when the pressure measured (incoming to the I/O connector) reach the pressure threshold set. In this operation mode the display shows:

S	U	B	L	.		P	R	E	S	S	U	R	E		↕
	X	X	X	X	X		m	b	a	r					

To end sublimation press the **SUBLIMATION** key and the relevant Led is turned off.

Operation in REMOTE SET Mode

The operation is the same previously described for **MANUAL** operation, but the current depends on the signal incoming to the I/O connector.

To end sublimation, press the **SUBLIMATION** key and the relevant Led is turned off.

In this operating mode it is possible to display the current measured on the incoming signal on the I/O connector pressing **SET** key. The display shows:

I	m	i	s		=		X	X	.	X		A			
													R	E	M

To escape from this message press the **SET** key again or wait 30 second without pressing any key.

Operation in AUTOMAT/REMOTE Mode

The operation is the same as previously described for AUTOMATIC operation, but the current depends on the signal incoming to the I/O connector. The display shows:

S	U	B	L	.		P	R	E	S	S	U	R	E		↕
	X	X	X	X	X		m	b	a	r					

To end sublimation, press the **SUBLIMATION** key and the relevant Led is turned off.

In this operating mode, as in REMOTE SET, it is possible to display the current measured on the incoming signal on the I/O connector pressing **SET** key. The message displayed is the same shown in REMOTE SET operating mode excepted for the script **A/R** in place of **REM** at the end of the second row.

Sublimation Timing

In the next page the figures of the sublimation timing in the different operating modes are shown.

With the Sublimation Period set to CONTINUOS the first Sublimation Cycle becomes endless. The sublimation can be stopped with **SUBLIMATION ON-OFF** key.

Operational Flow-Chart

In the following page it is shown the operational flowchart that indicates all the major function of the Sublimation Controller is shown.

5 Technical Information
Operational Flow-Chart

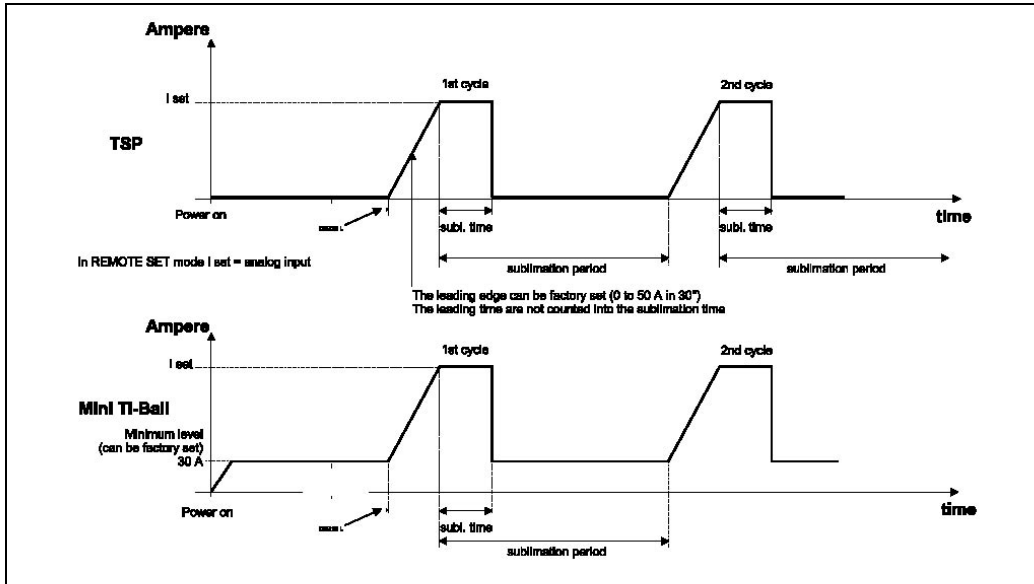

Figure 12 Sublimation Timing in MANUAL and REMOTE SET operating mode

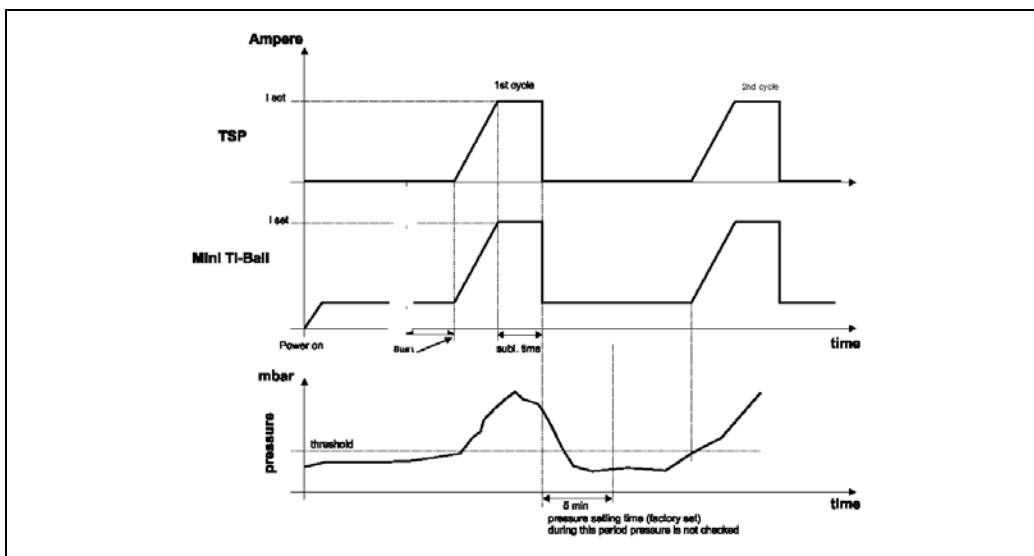

Figure 13 Sublimation Timing in AUTOMATIC and AUTOMAT/ REMOTE operating mode

Front Panel Leds Meaning

The controller front panel is equipped with some LEDs that explain the unit status.

TSP FILAMENT (3 LEDs)

- LED Filament Blinking with the controller configured in RECOVER MANUAL = filament active but defective; with the controller configured in RECOVER AUTOMATIC = filament not active but detected defective.
- LED Filament ON = filament active and not defective.

Serial Communication Protocol

Serial Communication Description

This unit can communicate by two different protocols:

- protocol (old system) “letter”
- “Window” protocol (new system)

These two protocols can be used as well with 232 or 485 media.

NOTE

Please use “Window” protocol for new projects development.

Letter Protocol Description

Communication Format

- 8 data bit
- no parity
- 1 stop bit
- baud rate: 600/1200/2400/4800/9600/19200/38400 programmable

Communication Protocol

- Master/Slave type with host computer Master and Controller Slave
- Maximum peripheral number: 32 (only for RS 485 protocol)

The communication is performed in the following way:



Message is a string with the following format:

<ADR>+<LDAT>+<DATA>+<CRC>

5 Technical Information

Letter Protocol Description

where:

- **<ADR>**: 0x80+peripheral address (from 0x1 to 0x20). An invalid address set the unit as unit 1.
- **<LDAT>**: data field length. It is encoded in decimal with two character (from 00 to 99).
- **<DATA>**: variable length field according to the command type, with the following elements:
 - **Command**: upper or lower case letter corresponding to the command (see the table of the following page):
 - **Parameters**: this is a string with length and content variable according to the command. When the command is a data reading one, this field contains the “?” (0x3f hexadecimal) character. When the command is a data setting one, or when the **Message** is a Controller answer to a reading command, this field contains a data string of one of the following types:

Tab. 5

DATA TYPE	VALID CHARACTER
Logic	0 1
Numeric	5 characters numeric string right justified with “0”.
Exponential	A string with the following format: “XXe-YY”

- **<CRC>**: XOR of all characters of the **Message**, with the exclusion of CRC, and with the most significant bit set to 0.

The addressed slave unit will respond with an **Answer** whose structure depends from the received **Message**:

- when the **Message** has a wrong CRC, or an unavailable address, or an incorrect field length/data type, or an unknown command, the **Answer** will not contain any character;
- the **Answer** will contain the ACK character (0x6 hexadecimal) to confirm the setting of the parameter associated with the command sent from Master when the command is a writing one;
- the **Answer** will contain a **Message** with the same structure of the **Message** previously described, but with **<DATA>** field containing the Master requested parameter and with the **<ADR>** field with the most significant bit set to 0 when the command is a reading one.

5 Technical Information
Letter Protocol Description

Tab. 6

COMMAND	DESCRIPTION	DATA TYPE	READ/WRITE	ADMITTED VALUES
A	Autostart	Logic	R/W	0 = YES 1 = NO
B	Baud rate	Numeric	R/W	0 = 600 1 = 1200 2 = 2400 3 = 4800 4 = 9600 5 = 19200 6 = 38400
C	Input current reading (measurement unit: 0,1 A)	Numeric	R	
D	Address (not available for RS 232 interface board)	Numeric	R/W	from 1 to 32
E	Error Code	Numeric	R	0 = no error 1 = overtemperature 2 = Mini Ti-Ball interrupt. 3 = TSP filament interrupt 4 = TSP defective 5 = short circuit
F	Active filament	Numeric	R/W	0 = Mini Ti-Ball 1 = filament 1 of TSP 2 = filament 2 of TSP 3 = filament 3 of TSP
G	Controller start/stop	Logic	R/W	0 = stop 1 = start
H	Pressure threshold	Exponential	R/W	from "01e-10" to "01e-04"
I	Output RMS current reading (measurement unit: 0,1 A)	Numeric	R	
L	Input pressure reading (measurement unit: 0,1 V)	Exponential	R	
M	Controller operating mode	Numeric	R/W	0 = manual 1 = automatic 2 = remote 3 = automatic/remote

COMMAND	DESCRIPTION	DATA TYPE	READ/WRITE	ADMITTED VALUES
N	Sublimation current (measurement unit: 0,1 A; this value is rounded to 0,5 A)	Numeric	R/W	300 = 30 A 305 = 30,5 A 495 = 49,5 A 500 = 50 A
P	Sublimation period	Numeric	R/W	30 = 3 minutes 100 = 10 minutes 300 = 30 minutes 600 = 1 hour 1200 = 2 hours 2400 = 4 hours 48000 = 8 hours 19200 = 32 hours
R	Recover	Logic	R/W	0 = automatic 1 = manual
S	Controller status	Numeric	R	0 = stop 1 = fail 2 = wait interlock 3 = ramp 4 = wait sublimation 5 = sublimation
T	Sublimation time (measurement unit: 0,1 min.)	Numeric	R/W	10 = 1 minute 15 = 1,5 minutes 150 = 15 minutes
V	Absorbed voltage (measurement unit: 0,1 V)	Numeric	R	

Example of TSP Messages

Tab. 7

ADD.	CMD	R/ W	TYPE	VALUE	MESSAGE	RESPONCE	COMMENT
1	R	R	L	-	81 30 32 52 JF 6E 0 2 R ?	01 30 32 52 J0 61 0 2 R 0	Reads Recover status (value = 1)
1	R	W	L	1	81 30 32 52 31 60 0 2 R 1	06	Writes Recover status to 1
1	R	W	L	0	81 30 32 52 30 61 0 2 R 0	06	Writes Recover status to 0
1	T	R	N	-	81 30 32 54 3F 68 0 2 T ?	01 30 36 54 30 30 31 30 62 0 6 T 0 0 0 1 0	Reads Sublimation time (value = 10)
1	T	W	N	00600	81 30 36 54 30 30 36 30 30 56 0 6 T 0 0 6 0 0	06	Writes Sublimation time to 600
1	H	R	P	-	81 30 32 48 JF 74 0 2 H ?	01 30 37 4B 30 31 65 2D 30 37 00 0 7 H 0 1 e - 0 7	Reads Pressure Threshold (value = 1 and -7)
1	H	W	P	05e-06	81 30 37 48 30 35 65 2D 30 36 05 0 7 H 0 5 e - 0 6	06	Writes Pressure Threshold to 5 and -6

Add Device address
 Cmd Command (A, B, C...)
 R/W Operation (Read/Write)
 Type Data type (Logical/Numeric/Power)

The "MESSAGE" and "RESPONSE" fields are represented in hex format (the corresponding ASCII values are indicated, wherever possible, under each byte).

Window Protocol Description

Communication Format

- 8 data bit
- no parity
- 1 stop bit
- baud rate: 600/1200/2400/4800/9600/19200/38400 programmable

Communication Protocol

The communication protocol is a MASTER/SLAVE type where:

- Host = MASTER
- Controller = SLAVE

The communication is performed in the following way:

1. the host (MASTER) send a MESSAGE + CRC to the controller (SLAVE);
2. the controller answer with an ANSWER + CRC to the host.

The MESSAGE is a string with the following format:

```
<STX>+<ADDR>+<WIN>+<COM>+<DATA>+<ETX>+<CRC>
```

where:

NOTE

When a data is indicated between two quotes ('...') it means that the indicated data is the corresponding ASCII character.

5 Technical Information

Window Protocol Description

- <STX> (Start of transmission) = 0x02
- <ADDR> (Unit address) = 0x80 (for RS 232)
<ADDR> (Unit address) = 0x80 + device number (0 to 31) (for RS 485)
- <WIN> (Window) = a string of 3 numeric character indicating the window number (from '000' to '999'); for the meaning of each window see the relevant paragraph.
- <COM> (Command) = 0x30 to read the window, 0x31 to write into the window
- <DATA> = an alphanumeric ASCII string with the data to be written into the window. In case of a reading command this field is not present. The field length is variable according to the data type as per the following table:

Tab. 8

Data Type	Field Length	Valid Characters
Logic (L)	1	'0' = OFF '1' = ON
Numeric (N)	6	'-', '.', '0' ... '9' right justified with '0'
Alphanumeric (A)	10	from blank to '_' (ASCII)

- <ETX> (End of transmission) = 0x03
- <CRC> = XOR of all characters subsequent to <STX> and including the <ETX> terminator. The value is hexadecimal coded and indicated by two ASCII character.

The addressed SLAVE will respond with an ANSWER whose structure depends from the MESSAGE type.

When the MESSAGE is a reading command, the SLAVE will respond transmitting a string with the same structure of the MESSAGE.

NOTE

Using the RS 485 interface, the message structure remains identical to the one used for the RS 232 interface, the only difference being that the value assigned to the ADDRESS <ADDR>.

The controller can answers with the following response types:

Tab. 9

Response Type	Response Length	Response Value	Description
Logic	1 byte	-	after a read instruction of a logic window
Numeric	6 bytes	-	after a read instruction of a numeric window
Alphanumeric	10 bytes	-	after a read instruction of an alphanumeric window
ACK	1 byte	(0x6)	the command execution has been successfully completed
NACK	1 byte	(0x15)	the command execution has been failed
Unknown Window	1 byte	(0x32)	the specified window in the command is not a valid window
Data Type Error	1 byte	(0x33)	the data type specified in the command (Logic, Numeric or Alphanumeric) is not accorded with the specified Window
Out of Range	1 byte	(0x34)	the value expressed during a write command is out of the range value of the specified window
Win Disabled	1 byte	(0x35)	the specified window is Read Only or temporarily disabled (for example you can't write the Soft Start when the Pump is running)

5 Technical Information
Window Protocol Description

Examples:

Command: START

Source: PC
 Destination: Controller

02	80	30	31	31	31	31	03	42	33
STX	ADDR	WINDOW			WR	ON	ETX	CRC	

Source: Controller
 Destination: PC

02	80	06	03	38	35
STX	ADDR	ACK	ETX	CRC	

Command: STOP

Source: PC
 Destination: Controller

02	80	30	31	31	31	30	03	42	32
STX	ADDR	WINDOW			WR	OFF	ETX	CRC	

Source: Controller
 Destination: PC

02	80	06	03	38	35
STX	ADDR	ACK	ETX	CRC	

Command: READ CONTROLLER STATUS

Source: PC

Destination: Controller (with address = 3)

02	83	32	30	35	30	03	38	37
STX	ADDR	WINDOW		RD	ETX	CRC		

Source: Controller (with address = 3 in stop status)

Destination: PC

02	80	32	30	35	30	30	30	30	30	03	38	47
STX	ADDR	WINDOW		DATA (STATUS)						ETX	CRC	

Command: READ SERIAL TYPE

Source: PC

Destination: Controller (with address = 3 in 485 mode)

02	83	35	30	34	30	03	38	31
STX	ADDR	WINDOW		RD	ETX	CRC		

Source: Controller

Destination: PC

02	83	35	30	34	30	31	03	42	30
STX	ADDR	WINDOW		RD	DATA	ETX	CRC		

Window-Meanings

Tab. 10

N.	Read/ Write	Data Type	Description	Admitted Values
008	R/W	N	Remote (default), Serial or Local configuration	Local=2 Serial = 0 (default = 0)
011	R/W	L	Start/Stop	011 Start = 1 Stop = 0
108	R/W	N	Baud rate	600 = 0 1200 = 1 2400 = 2 4800 = 3 9600 = 4 19200 = 5 38400 = 6 (default = 4)
205	R	N	Controller status	0 = stop 1 = fail 2 = wait interlock 3 = ramp 4 = wait sublimation 5 = sublimation
206	R	N	Error code	0 = no error 1 = overtemperature 2 = Mini Ti-Ball interrupt. 3 = TSP filament interrupt 4 = TSP defective 5 = short circuit
211	R	N	Controller Heat sink Temperature (°C)	
216	R	N	Controller CPU Temperature (°C)	
319	R	A	Controller model	
323	R	A	Controller serial number	
325	R/W	A	Electrical modification level	
398	R	N	Controller cycle number	
399	R	N	Controller life in hours	

N.	Read/ Write	Data Type	Description	Admitted Values
400	R	A	Program Listing CRC	
401	R	A	Boot Loader CRC	
402	R	A	Parameter Listing CRC	
404	R	A	Parameter Structure CRC	
406	R	A	Program Listing Code & Revision	
407	R	A	Parameter Listing Code & Revision	
457	R	A	Modification level CPU	
458	R	A	Serial number CPU	
503	R/W	N	RS 485 address	0 to 31 (default = 0)
504	R/W	L	Serial type select	0 = RS 232 1 = RS 485 (default = 0)
601	R/W	A	Operating mode	Bit 0 = Autostart (0=Yes, 1=No) Bit 1-8 = - Bit 9 = Recover (0=Automatic, 1=Manual)
615	R/W	A	Pressure threshold	from "01e-10" to "01e-04" (default =01e-7)
670	R/W	N	Controller operating mode	0 = manual 1 = automatic 2 = remote 3 = automatic/remote
671	R/W	N	Active filament	0 = Mini Ti-Ball 1 = filament 1 of TSP 2 = filament 2 of TSP 3 = filament 3 of TSP (default = 1)
672	R/W	N	Sublimation current (measurement unit: 0,1 A; this value is rounded to 0,5 A)	300 = 30 A 305 = 30,5 A 495 = 49,5 A 500 = 50 A

5 Technical Information
Window Protocol Description

N.	Read/ Write	Data Type	Description	Admitted Values
				(default = 300)
673	R/W	N	Sublimation period (measurement unit: 0,1 min.)	0 = continuous 30 = 3 minutes 100 = 10 minutes 300 = 30 minutes 600 = 1 hour 1200 = 2 hours 2400 = 4 hours 48000 = 8 hours 19200 = 32 hours (default = 30)
674	R/W	N	Sublimation time (measurement unit: 0,1 min.)	10 = 1 minute 15 = 1,5 minutes 70 = 7 minutes 150 = 15 minutes (default = 10)
675	R/W	N	Waiting time after sublimation cycle (measurement unit: 0,1 min.)	10 = 1 minute 990 = 99 minutes (default =50)
803	R	A	Interlock Status	Bit 0 = 1 Open, = 0 Closed
810	R	N	Output voltage (measurement unit: 0,1 V)	
811	R	N	Output current (measurement unit: 0,1 A)	
816	R/W	N	Display contrast	0 to 15 (default = 10)
817	R/W	N	Front Panel LED intensity	1 to 20 (default = 3)
851	R	N	Current Input (measurement unit: 0,1 A)	Analog Input 0 /10V
852	R	A	Pressure Input (measurement unit: mBar)	Analog Input 0 /5V

Orderable parts

The Sublimation Controller spare parts are listed in the following table.

Tab. 11

Description	Part number
Accessories	
Rack Adapter	929-0064
Cables	
Cable for TSP pump	924-0730
Cable for Mini Ti-Ball pump	924-0752



Vacuum Products Division

Dear Customer,

Thank you for purchasing an Agilent vacuum product. At Agilent Vacuum Products Division we make every effort to ensure that you will be satisfied with the product and/or service you have purchased.

As part of our Continuous Improvement effort, we ask that you report to us any problem you may have had with the purchase or operation of our products. On the back side you find a Corrective Action request form that you may fill out in the first part and return to us.

This form is intended to supplement normal lines of communications and to resolve problems that existing systems are not addressing in an adequate or timely manner.

Upon receipt of your Corrective Action Request we will determine the Root Cause of the problem and take the necessary actions to eliminate it. You will be contacted by one of our employees who will review the problem with you and update you, with the second part of the same form, on our actions.

Your business is very important to us. Please, take the time and let us know how we can improve.

Sincerely,

A handwritten signature in black ink, appearing to read "Giampaolo LEVI".

Giampaolo LEVI

*Vice President and General Manager
Agilent Vacuum Products Division*

Note: Fax or mail the Customer Request for Action (see backside page) to Agilent Vacuum Products Division (Torino) – Quality Assurance or to your nearest Agilent representative for onward transmission to the same address.



Vacuum Products Division Instructions for returning products

Dear Customer,

Please follow these instructions whenever one of our products needs to be returned.

Complete the attached **Request for Return form** and send it to Agilent Technologies (see below), taking particular care to include the completed **Health and Safety** declaration Section. No work can be started on your unit until we receive a completed copy of this form.

After evaluating the information, Agilent Technologies will provide you with a **Return Authorization (RA) number** via email or fax, as requested. Note: Depending on the type of return, a Purchase Order may be required at the time **the Request for Return is submitted**. We will quote any necessary services (evaluation, repair, special cleaning, eg).

Product preparation

- Remove all accessories from the core product (e.g. inlet screens, vent valves).
- Prior to shipment and if applicable for your product, drain any oils or other liquids, purge or flush all gasses, and wipe off any excess residue.
- If ordering an Advance Exchange product, please use the packaging from the Advance Exchange to return the defective product.
- Seal the product in a plastic bag, and package product carefully to avoid damage in transit. You are responsible for loss or damage in transit.
- Include a copy of the Health and Safety Declaration in the shipping documentation on the outside of the shipping box of your returning product.
- Clearly label package with RA number. Using the shipping label provided will ensure the proper address and RA number are on the package. Packages shipped to Agilent without a RA clearly written on the outside cannot be accepted and will be returned.
- Return only products for which the RA was issued.

Shipping

- Ship to the location specified on the printable label, which will be sent, along with the RA number, as soon as we have received all of the required information. Customer is responsible for freight charges on returning product.
- Return shipments must comply with all applicable Shipping Regulations (IATA, DOT, ADR, etc.) and carrier requirements.

RETURN THE COMPLETED **REQUEST FOR RETURN** FORM TO YOUR NEAREST LOCATION:

EUROPE:

Fax: 00 39 011 9979 330

Fax Free: 00 800 345 345 00

Toll Free: 00 800 234 234 00

vpt-customer@agilent.com

NORTH AMERICA:

Fax: 1 781 860 9252

Toll Free: 800 882 7426

vpl-ra@agilent.com

PACIFIC RIM:

please visit our website for individual
office information

<http://www.agilent.com>



TERMS AND CONDITIONS

Please read the terms and conditions below as they apply to all returns and are in addition to the Agilent Technologies Vacuum Product Division – Products and Services Terms of Sale.

- Unless otherwise pre-negotiated, customer is responsible for the freight charges for the returning product. Return shipments must comply with all applicable **Shipping Regulations** (IATA, DOT, etc.) and carrier requirements.
- Agilent Technologies is not responsible for returning customer provided packaging or containers.
- Customers receiving an Advance Exchange product agree to return the defective, rebuildable part to Agilent Technologies **within 15 business days**. Failure to do so, or returning a non-rebuildable part (crashed), will result in an invoice for the non-returned/non-rebuildable part.
- Returns for credit toward the purchase of new or refurbished Products are subject to prior Agilent approval and may incur a restocking fee. Please reference the original purchase order number.
- Units returned for evaluation will be evaluated, and a quote for repair will be issued. If you choose to have the unit repaired, the cost of the evaluation will be deducted from the final repair pricing. A Purchase Order for the final repair price should be issued within 3 weeks of quotation date. Units without a Purchase Order for repair will be returned to the customer, and the evaluation fee will be invoiced.
- Products returned that have not been drained from oil will be disposed.
- A Special Cleaning fee will apply to all exposed products
- If requesting a calibration service, units must be functionally capable of being calibrated.



Vacuum Products Division
Request for Return Form

Customer information
Company :
Address:
Contact Name:
Tel:
Fax:
Email:

Equipment
Product description
Agilent PartNo
Agilent Serial No
Original Purchasing Reference
Failure description
Type of process (for which the equipment was used)

Type of return
Non Billable
Billable
Exchange
Repair
Upgrade
Consignment/Demo
Calibration
Evaluation
Return for Credit

Health and safety
Substances (please refer to MSDS forms)
The product has been exposed to the following substances:
Toxic
Harmful
Corrosive
Reactive
Flammable
Explosive (*)
Radioactive (*)
Biological (*)
Oxidizing
Sensitizer
Other dangerous substances

Goods preparation
If you have replied YES to one of the above questions. Has the product been purged?
If yes, which cleaning agent/method:
Has the product been drained from oil?
I confirm to place this declaration on the outside of the shipping box.

I declare that the above information is true and complete to the best of my knowledge and belief.
I understand and agree to the terms and conditions on page 2 of this document.

Name:
Position:
Date:
Authorized Signature:

NOTE: If a product is received at Agilent which is contaminated with a toxic or hazardous material that was not disclosed, the customer will be held responsible for all costs incurred to ensure the safe handling of the product, and is liable for any harm or injury to Agilent employees as well as to any third party occurring as a result of exposure to toxic or hazardous materials present in the product.

Agilent Vacuum Products Division/Sales and Service Offices

United States

Agilent Technologies

121 Hartwell Avenue
Lexington, MA 02421 - USA
Tel.: +1 781 861 7200
Fax: +1 781 860 5437
Toll-Free: +1 800 882 7426
vpl-customerservice@agilent.com

Benelux

Agilent Technologies Netherlands B.V.

Groenelaan 5, 1186 AA Amstelveen
The Netherlands
Tel: +31 20 547 2000
Fax: +31 20 547 2093

Brazil

Agilent Technologies Brasil

Avenida Marcos Penteados de Ulhoa
Rodrigues, 939 - 6° andar
Castelo Branco Office Park
Torre Jacarandá - Tamboré
Barueri, Sao Paulo CEP: 06460-040
Toll free: 0800 728 1405

China

Agilent Technologies (China) Co. Ltd

No.3, Wang Jing Bei Lu, Chao Yang District
Beijing, 100102, China
Tel: +86 (0)10 64397888
Fax: +86 (0)10 64391318
Toll free: 800 820 3278
vacuum.cnmarketing@agilent.com
vpc-customerservice@agilent.com

France

Agilent Technologies

Parc Technopolis - Z.A. de Courtaboeuf
3, avenue du Canada - CS 90263
91978 Les Ulis cedex, France
Tel: +33 (0) 1 64 53 61 15
Fax: +33 (0) 1 64 53 50 01
vpf.sales@agilent.com

Germany and Austria

Agilent Technologies

Sales & Services GmbH & Co. KG

Lyoner Str. 20
60 528 Frankfurt am Main
GERMANY
Tel: +49 69 6773 43 2230
Fax: +49 69 6773 43 2250

India

Agilent Technologies India Pvt. Ltd.

Unit Nos 105-116
First Floor, Splendor Forum,
Plot No.-3, District Centre, Jasola
New Delhi-110025
Ph: +91 11 4623 7100
Fax: +91 4623 7105
Toll Free: 18001801517

Italy

Agilent Technologies Italia S.p.A.

Via F.lli Varian, 54
10040 Leini, (Torino) - Italy
Tel: +39 011 9979 111
Fax: +39 011 9979 350
Toll free: 00 800 234 234 00
vpt-customerservice@agilent.com

Japan

Agilent Technologies Japan, Ltd.

8th Floor Sumitomo Shibaura Building
4-16-36 Shibaura Minato-ku
Tokyo 108-0023 - Japan
Tel.: +81 3 5232 1253
Fax: +81 3 5232 1710
Toll-Free: 0120 655 040
vpj-customerservice@agilent.com

Korea

Agilent Technologies Korea, Ltd.

Shinsa 2nd Bldg. 2F, 966-5 Daechi-dong
Kangnam-gu, Seoul
Korea 135-280
Tel: +82 (0)2 2194 9449
Fax: +82 (0)2 3452 3947
Toll free: 080 222 2452
vpk-customerservice@agilent.com

Mexico

Agilent Technologies

Concepcion Beistegui No 109
Col Del Valle
C.P. 03100 – Mexico, D.F.
Tel.: +52 5 523 9465
Fax: +52 5 523 9472

Singapore

Agilent Technologies Singapore Pte. Ltd.

1 Yishun Avenue 7,
Singapore 768923
Tel : (65) 6215 8045
Fax : (65) 6754 0574
Toll free: 1 800 2762622
vps-customerservice@agilent.com

Southeast Asia

Agilent Technologies Sales Sdn Bhd

Unit 201, Level 2 uptown 2,
2 Jalan SS21/37, Damansara Uptown
47400 Petaling Jaya,
Selangor, Malaysia
Tel : +603 7712 6106
Fax: +603 6733 8121
Toll free: 1 800 880 805
vps-customerservice@agilent.com

Taiwan

Agilent Technologies Taiwan Limited

20 Kao-Shuang Road Ping-Chen City
Tao-Yuan Hsien,
32450 Taiwan, R.O.C.
Tel: +886 3 4959004
Toll free: 0800 018 768
vpw-customerservice@agilent.com

UK and Ireland

Agilent Technologies UK, Ltd.

6 Mead Road Oxford Industrial Park
Yarnton, Oxford OX5 1QU – UK
Tel.: +44 (0) 1865 291570
Fax: +44 (0) 1865 291571

Other Countries

Agilent Technologies Italia S.p.A.

Via F.lli Varian, 54
10040 Leini, (Torino) - Italy
Tel.: +39 011 997 9111
Fax: +39 011 997 9350
Toll-Free: 00 800 234 234 00

Customer Support & Service

NORTH AMERICA:

Toll Free: 800 882 7426
vpl-ra@agilent.com

EUROPE:

Toll Free: 00 800 234 234 00
vpt-customer-care@agilent.com

PACIFIC RIM:

please visit our website for individual office
information

<http://www.agilent.com/chem/vacuum>

Worldwide Web Site, Catalog and Order On-line:

www.agilent.com/chem/vacuum

Representatives in most countries

12/13

© Agilent Technologies, Inc. 2014

Printed in ITALY

06/2014

Publication Number: 87-900-138-01 (A)



Agilent Technologies



Agilent Technologies