

# Instruction Manual (C)

## SCU-1600 Control Unit

<i>Description</i>	<i>Voltage</i>
<i>SCU-1600 Control Unit</i>	<i>200 - 240 Va.c.</i>

STP pump consists of the three-volumed Instruction Manuals.

Instruction Manual (A):	STP pump generic Instruction Manual
-------------------------	-------------------------------------

Instruction Manual (B):	STP pump specific information
-------------------------	-------------------------------

➡ <b>Instruction Manual (C):</b>	<b>STP control unit Instruction Manual</b>
<b>(This Instruction Manual)</b>	<b>Supplied with STP control unit</b>



The description of this product consists of the three-volumed Instruction Manuals. Read through each Instruction Manual before operation.

The separate volume contents of each description are as follows:

### **Instruction Manual (A)**

STP pump generic Instruction Manual:

- Introduction
- Installation of the STP pump
- Installation of the STP control unit
- Operation
- Safety functions
- Maintenance and inspection
- Storage and disposal
- Service, Spares and accessories

### **Instruction Manual (B)**

STP pump specific information:

- Technical data
- How to Secure the STP pump
- Temperature Management System (TMS)

### **Instruction Manual (C)**

STP control unit Instruction Manual:

- Introduction
- Technical data
- Installation
- Operation
- Serial communication protocol
- STP-Link (except for SCU-750)
- Maintenance
- Storage, transportation and disposal
- Service, spares, and accessories

Keep the manuals in an easily accessible location.



# Declaration of Conformity

We,  
Manufacture: Edwards Japan Limited  
1078-1, Yoshihashi, Yachiyo-shi, Chiba, 276-8523, Japan  
EU Representative: Edwards Limited  
Manor Royal, Crawley, West Sussex, RH10 9LW, UK

declare under our sole responsibility, as manufacturer and person within the EU authorised to assemble the technical file, that the product(s)

Product Name: Control unit for turbomolecular pump  
Model Number: SCU-1600  
Accessories Covered: TMS Unit, Lon Communication Unit

to which this declaration relates is in conformity with the following standard(s) or other normative document(s)

EN61010-1:2001 Safety requirements for electrical equipment for measurement, control and laboratory Use. General requirements  
EN61326-1:2006 Electrical equipment for measurement, control & laboratory Use. EMC requirements. General requirements (Immunity: Industrial locations, Emission: Class A)  
EN61000-6-2:2005 Electromagnetic compatibility (EMC). Generic standards. Immunity for industrial environments  
EN55011:2007, A2:2007 Industrial, scientific and medical (ISM) radio-frequency equipment. Electromagnetic disturbance characteristics (Group1, Class A)

and fulfils all the relevant provisions of

2006/95/EC Low Voltage Directive  
2004/108/EC Electromagnetic Compatibility (EMC) Directive  
2002/95/EC\* Restriction of Certain Hazardous Substances (RoHS) Directive

*\* i.e. The product(s) contain less than - 0.1wt% for hexavalent chromium, lead, mercury, PBB and PBDE; 0.01wt% for cadmium - in homogeneous materials (subject to the exemptions allowed by the Directive). This information relates only to products sold on or after the date of this certificate. Edwards has taken all reasonable steps to confirm this statement, which is based mainly on information from our suppliers. Whilst the RoHS Directive does not legally apply to this vacuum equipment, we recognize that component compliance is relevant to many of our customers.*

Manufacture: Yuji Kato  
Yuji Kato, TMP Technical Senior Manager, Edwards Japan Limited

1<sup>st</sup> Mar. 2010, Yachiyo  
Date and Place

EU representative: B. Brewster  
Barrie D Brewster, Technical Manager, Edwards Limited

5<sup>th</sup> Mar. 2010, Burgess Hill  
Date and Place

This product has been manufactured under a quality system registered to ISO9001

VI-DOC-76-001

This page intentionally blank

# CONTENTS

Section	Title	Page
1	INTRODUCTION	1
1.1	Scope and definitions	1
1.2	Applied standards	2
1.3	Limited warranty	2
1.3.1	Warranty period	2
1.3.2	Item warranted	2
1.3.3	Disclaimer	2
1.3.4	Spare parts	3
1.4	Labels	3
1.5	Label affixing positions	5
1.6	General description	6
1.6.1	Cable sets	7
2	TECHNICAL DATA	9
2.1	SCU-1600 specifications	9
3	INSTALLATION	13
3.1	Unpacking	13
3.2	Front panel	13
3.3	Rear panel	16
3.4	Precautions before installation	17
3.4.1	Operating environment	17
3.4.2	Insulation test	17
3.4.3	Installation area	18
3.5	Attaching the SCU-1600 to a rack	19
3.6	Cable connection	20
3.6.1	STP connection cable	21
3.6.2	TMS connection cable	22
3.6.3	Power cable	24
3.7	Connecting to semiconductor equipment	27
3.7.1	Connecting to power	27
3.7.2	Emergency off circuit (EMO circuit)	27
3.8	Remote communication	28
3.8.1	Parallel communication	28
3.8.2	Serial communication	28
3.9	Adjustment methods	29
3.9.1	Tuning	29
3.9.2	Tuning method	29
3.9.3	Change of data after tuning	32
3.10	Confirmation mode	33
3.10.1	Confirmation method	33
3.11	Parameter set mode	35
3.11.1	Remote operation setting	35
3.11.2	Rotational speed setting	35
3.11.3	TMS setting	35
3.11.4	Rotational inhibit signal setting	35

## CONTENTS (CONTINUED)

Section	Title	Page
3.11.5	Second speed option setting	35
3.11.6	Second speed setting	35
3.11.7	Optional output signal setting (Emergency vent valve setting)	36
3.11.8	Second Damage Limit setting	36
3.11.9	Warning function setting	37
3.11.10	Serial port COM1 setting	38
3.11.11	Serial port COM2 setting	38
3.11.12	Date/Time setting	38
3.11.13	Factory setting	38
3.11.14	Parameter setting procedure	39
3.12	Manual operation mode	45
4	OPERATION	47
4.1	Before starting the STP pump	47
4.1.1	Confirmation before starting	47
4.1.2	Confirmation of vacuum system	47
4.2	Powering ON	48
4.2.1	Self test	48
4.2.2	"CAUTION" message in the self test state	48
4.3	How to start/stop the STP pump	49
4.4	Manual start/stop the STP pump	49
4.4.1	Starting the STP pump	49
4.4.2	Stopping the STP pump	49
4.4.3	Starting the STP pump after stopping	49
4.5	Remote operation	51
4.5.1	Input signal pins	51
4.5.2	Output signal pins	55
4.5.3	Remote setting	59
4.5.4	Starting/Stopping the STP pump	59
4.5.5	Rotation INHIBIT signal	60
4.5.6	Second speed option	61
4.5.7	Starting the STP pump after stopping	63
4.5.8	Starting the STP pump after a safety function operates	63
4.6	Powering OFF	63
4.7	Operating the TMS unit (for use with the TMS unit)	64
4.7.1	Before starting	64
4.7.2	Starting/Stopping	64
4.7.3	Setting the TMS unit function	64
4.7.4	Temperature control	64

## CONTENTS (CONTINUED)

Section	Title	Page
5	SERIAL COMMUNICATION PROTOCOL	65
5.1	Introduction	65
5.2	Connection and setting up	65
5.2.1	Signal connection	65
5.2.2	Connecting the RS485	68
5.2.3	Communication parameter setting	69
5.3	Protocol specifications	69
5.3.1	General description	69
5.3.2	Standard transmission frame (in the RS232/RS485 single point connection)	70
5.3.3	Control command (in the RS232/RS485 single point connection)	71
5.3.4	Query command (in the RS232/RS485 single point connection)	72
5.3.5	Transmission data format	73
5.3.6	Frame control (checksum)	74
5.3.7	Error control	74
5.3.8	Transmission frame in the RS485 multi-point connection	74
5.3.9	Control command in the RS485 multi-point connection	76
5.3.10	Query command in the RS485 multi-point connection	77
5.3.11	Broadcasting command in the RS485 multi-point connection	78
5.4	Command specifications	79
5.4.1	Command list	79
5.4.2	ReadMeas	80
5.4.3	Command	80
5.4.4	ReadFailMess	81
5.4.5	ReadModFonct	84
5.4.6	ReadVersion	86
5.4.7	ReadCounters	87
5.4.8	ReadSetPoint	88
5.4.9	ReadMotorTemp	88
5.4.10	ReadStatus	89
5.4.11	ReadEvents	90
5.4.12	SetSpeedSetPoint	91
5.4.13	ReadSpeedSetPoint	92
5.4.14	ReadModFonctWithWarning	93
5.4.15	ReadMeasValue	96
5.4.16	SetOptions	98
5.4.16.1	Second speed option setting	98
5.4.16.2	Second speed selection	99
5.4.17	ReadOptions	100
5.4.17.1	Second speed function setting	100
5.4.17.2	Second speed select	101

## CONTENTS (CONTINUED)

Section	Title	Page
6	STP-LINK	103
7	MAINTENANCE	105
7.1	Safety functions	105
7.1.1	Power failure	105
7.1.2	Operation after a power recovery	106
7.1.3	Abnormal state of magnetic bearing	107
7.1.4	Excessive vibration	107
7.1.5	Motor driver overload	107
7.1.6	Overheating inside the STP pump	107
7.1.7	Overheating inside the SCU-1600	107
7.1.8	Overspeed	108
7.1.9	Abnormality/Error in the TMS unit (for use with the TMS unit)	108
7.2	"WARNING" message function	109
7.2.1	"WARNING" message display function	109
7.3	"WARNING" message description	110
7.3.1	Damage point function	110
7.3.2	First damage limit	110
7.3.3	Second damage limit	110
7.3.4	Imbalance X_H, X_B, Z	111
7.3.5	Pump run time over	111
7.3.6	Pump overload	111
7.3.7	Low RTC battery	112
7.4	"WARNING" function setting	113
7.5	Error at self test state	114
7.5.1	Error after self test	115
7.5.2	Error messages	115
7.5.3	Troubleshooting immediately after power failure occurs	115
7.5.4	Troubleshooting immediately after other abnormality/errors occur	116
7.6	When error message is not displayed on LCD	124
7.6.1	Abnormalities when powering ON	124
7.6.2	Abnormalities when performing rotational operation	124
7.6.3	Other abnormalities	125
7.7	"Error Record" message display function	125
7.8	Maintenance and inspection	126
7.8.1	Cleaning	126
7.8.2	Overhaul	126
8	STORAGE, TRANSPORTATION AND DISPOSAL	127
8.1	Storage of the SCU-1600	127
8.2	Transporting for repair or overhaul	127
8.3	Disposal	128





*SCU-1600 Control Unit for Turbomolecular Pump*

## CONTENTS (CONTINUED)

Section	Title	Page
9	SERVICE, SPARES AND ACCESSORIES	129
9.1	Introduction	129
9.2	Service	129
9.3	Spares	129
9.4	Accessories	130

## ILLUSTRATIONS

Figure	Title	Page
1	High voltage device caution label	3
2	Safety instruction label	4
3	Caution label	4
4	Connector caution label	4
5	Voltage rating label	4
6	Label affixing positions	5
7	SCU-1600 control unit	6
8	Configuration of the STP pump with the TMS	7
9	SCU-1600 dimensions (mm)	11
10	SCU-1600 front panel	13
11	SCU-1600 rear panel	16
12	Installing the SCU-1600	18
13	Example of securing the SCU-1600	19
14	STP pump connection cable	21
15	TMS connection cable (with distribution box)	22
16	TMS connection cable (without sensor cable)	23
17	TMS connection cable (with sensor cable)	23
18	Power cable (without plug)	24
19	Power cable (with plug)	25
20	Connecting method of the power cable without plug	26
21	REMOTE X7 connector	28
22	Connector X3A, X3B (D-sub 9)	28
23	Tuning procedures	31
25	Parameter setting method	40
26	Parameter setting method (continued)	41
27	Parameter setting method (continued)	42
28	Parameter setting method (continued)	44
29	Manual operation method	45
30	Operational procedures	50
31	REMOTE X7 input signal pins	54
32	REMOTE X7 output signal pins	58
33	Serial communication	65
34	Connector X3A/X3B (D-sub 9)	66
35	Connector X7 (D-sub 37)	66
36	RS485 connections	68
37	PC to SIM communication	69

## TABLES

Table	Title	Page
1	Turbomolecular pumps	6
2	SCU-1600 front panel functions	14
3	SCU-1600 front panel functions (continued)	15
4	SCU-1600 rear panel connection	16
5	Power cable	25
6	User setting data list	32
7	Causes of "CAUTION" at the self test state	48
8	REMOTE X7 input signal pins	52
9	REMOTE X7 input signal pins (continued)	53
10	REMOTE X7 output signal pins	56
11	REMOTE X7 output signal pins (continued)	57
12	Rated contacts for relays CR1 to CR9	59
13	Starting/Stopping the STP pump during remote operation (REMOTE X7)	59
14	Rotation INHIBIT signal input	60
15	Second speed function	62
16	Reset operation during remote operation (REMOTE X7)	63
17	X3A/X3B pin position	65
18	X7 pin position	66
19	Communication parameters	69
20	Transmission control characters	70
21	Pump operation commands	78
22	Command list	79
23	Pump operation commands	81
24	Error message values	83
25	Error message values (continued)	84
26	Pump operation mode	85
27	Remote mode	90
28	Warning value bit assign	94
29	Option function number and parameter list	98
30	Option function number and parameter list	100
31	Functions of STP-Link	103
32	Backup rotational speed	105
33	States of LCD, LEDs and REMOTE output signals at a power failure	106
34	Accumulated damage point and warning message	110
35	Default setting of "WARNING" function	113
36	Factory setting and variable range	113
37	Error messages at self test state	114
38	Error messages after self test	117
39	Error messages after self test (continued)	118
40	Error messages after self test (continued)	119
41	Error messages after self test (continued)	120
42	Error messages after self test (continued)	121
43	Error messages after self test (continued)	122
44	Error messages after self test (continued)	123
45	Troubleshooting when powering ON	124
46	Troubleshooting when performing the STP pump start operation	124
47	Troubleshooting while the STP pump is rotating	125



---

*SCU-1600 Control Unit for Turbomolecular Pump*

This page intentionally blank.

# 1 INTRODUCTION

## 1.1 Scope and definitions

This manual provides installation, operation and maintenance instructions for the Edwards SCU-1600 control unit (abbreviated to "SCU-1600" throughout this manual) for the Turbomolecular pump (STP). You must use the SCU-1600 as specified in this manual.

The procedures in this manual must be followed before you install, operate and maintain the SCU-1600. Important safety information is highlighted as WARNING and CAUTION instructions; these instructions are mandatory. The use of WARNINGS and CAUTIONS is defined below.

	<b>WARNING</b> Warnings are given where failure to observe the instruction could result in serious injury or death to people.
---	--

<b>CAUTION</b> Cautions are given where failure to observe the instruction could result minor personal injury in damage to the equipment, associated equipment and/or process.
---

*Note: Items you must follow during operation and maintenance.*

Throughout this manual, page, figure and table numbers are sequential.

The units used throughout this manual conform to the SI international system of units of measurement; US equivalent units of measurement are also given.

The following IEC warning labels/symbols appear on the SCU-1600:



Warning - refer to accompanying documentation.



Warning - risk of electric shock.



Protective earth (ground).

*Note: An alarm function is incorporated into this STP series. Alarm and cautionary messages are displayed on the LCD of the SCU-1600. Note that the words "WARNING" and "CAUTION" displayed on the LCD indicate the need for overhaul of the pump or precautions during the operation. They do not have the same meaning as the much more serious symbols for "WARNING" and "CAUTION" used in the instruction manual.*

## SCU-1600 Control Unit for Turbomolecular Pump

### 1.2 Applied standards

The SCU-1600 conforms to the following directives and standards:

1. Applied Directives
  - EC Low Voltage Directive
  - EC Electromagnetic Compatibility Directive
2. Applied Standards
  - EN61010-1 / IEC61010-1
  - EN61326 (class A)
  - UL61010-1 (Electrical Equipment for Measurement, Control, and Laboratory Use)

### 1.3 Limited warranty

This WARRANTY applies to the customer to whom Edwards has delivered this product.

#### 1.3.1 Warranty period

Edwards warrants this product against defects for a period of two (2) years from the date of delivery or during the period specified in the agreement made by and between the customer and Edwards.

#### 1.3.2 Item warranted

1. This warranty applies only to the product delivered from Edwards to the customer.
2. If any defect is found during this period, Edwards will, at its option, repair or recondition the product free of charge. The costs for repair or replacement of the product after the warranty period has passed will be at your own charge.

#### 1.3.3 Disclaimer

Edwards makes no warranty with respect to any damage occurred due to any of the following during the warranty period:

1. Handling, operation or maintenance other than that specified herein.
2. Failure to follow any of the warnings or cautions enumerated in this manual.
3. Installation, operation or maintenance using parts which are not specified by Edwards.
4. Maintenance personnel other than those authorized by Edwards or Service office have disassembled, reconditioned, or tampered the product.

### SCU-1600 Control Unit for Turbomolecular Pump

5. Defect resulting from the not-specified use of the product.
6. When the product is used under special conditions without obtaining the written consent of Edwards (strong magnetic field and the radiation are added to the product).
7. Defect resulting from the installation of the product (exclude the installation by authorized personnel).
8. Deterioration in the external because of use (discoloration, scratches and so forth).
9. Product damage occurred during transport or other factors not attributable to Edwards.
10. Product breakage or damage due to natural disasters, fire or other external factors.
11. Deterioration in the basic performance due to the use of the product beyond limits of the use.
12. Any direct, incidental or consequential damage resulting from the use of the product.
13. When continuously operated without overhaul after the WARNING indication ("WARNING" message) on the LCD.
14. Overhaul and replacement of maintenance parts.

#### 1.3.4 Spare parts

- Air-cooling fan for SCU-1600. (When exchanging, contact Service Office).

#### 1.4 Labels

The following labels are affixed or printed to the SCU-1600. Read the contents of the labels before operation.

##### 1. High voltage device caution label

The SCU-1600 is equipped with a high voltage device. This label warns operators to pay attention to the high voltage device at the maintenance and inspection.

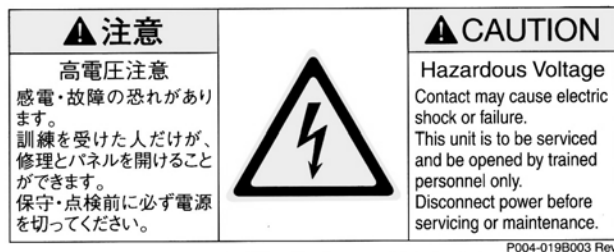

Figure 1 - High voltage device caution label

SCU-1600 Control Unit for Turbomolecular Pump

2. Safety instruction label

This label describes instructions before operating the SCU-1600.



Figure 2 - Safety instruction label

3. Caution label

This label describes precautions for operating the SCU-1600. Follow these precautions.

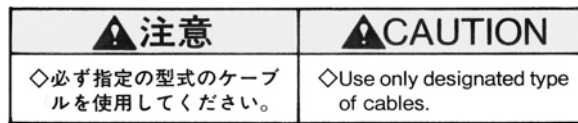

Figure 3 - Caution label

4. Connector caution label

This label describes lock of the connector.

The label instructs operators to prevent the connectors from being disconnected while the STP pump is in operation.

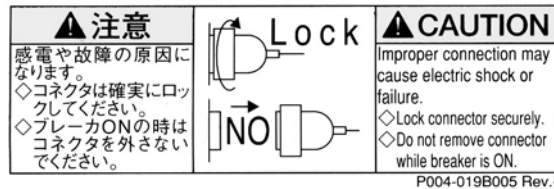

Figure 4 - Connector caution label

5. Voltage rating label

This label describes the rated voltage of the SCU-1600. Use voltage specified in this label.

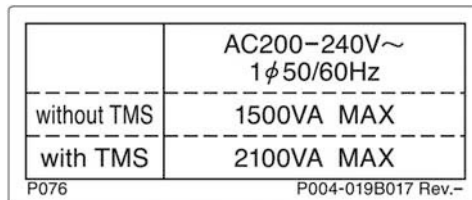

Figure 5 - Voltage rating label



SCU-1600 Control Unit for Turbomolecular Pump

1.5 Label affixing positions

Refer to Section 1.4 for the details of the labels 1 to 5.

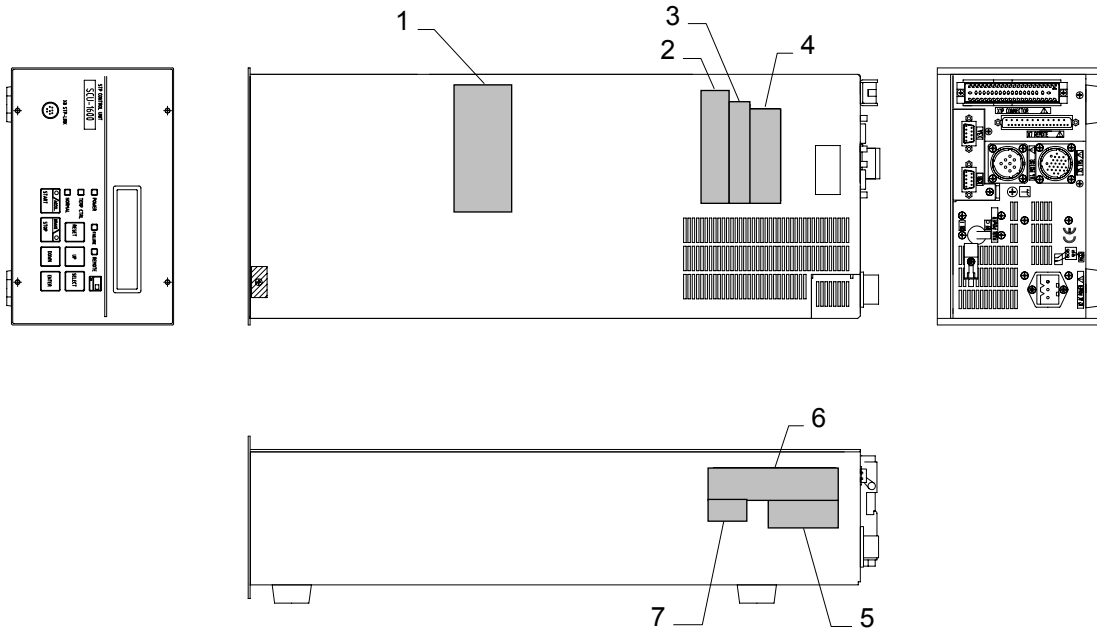

Figure 6 - Label affixing positions

- 1 High voltage device caution label
- 2 Safety instruction label
- 3 Caution label
- 4 Connector caution label
- 5 Voltage rating label
- 6 Name plate
- 7 Parts number

## SCU-1600 Control Unit for Turbomolecular Pump

### 1.6 General description

The SCU-1600 is the control unit required to drive the STP series of turbomolecular pumps. The SCU-1600 converts the single-phase line supply voltage into a 3-phase d.c. voltage to drive the pump motor. It also evaluates measured signals and performs the following functions:

- It provides logic to control the pump functions.
- It operates the magnetic bearing system.
- It operates the optional Temperature Management System (TMS).

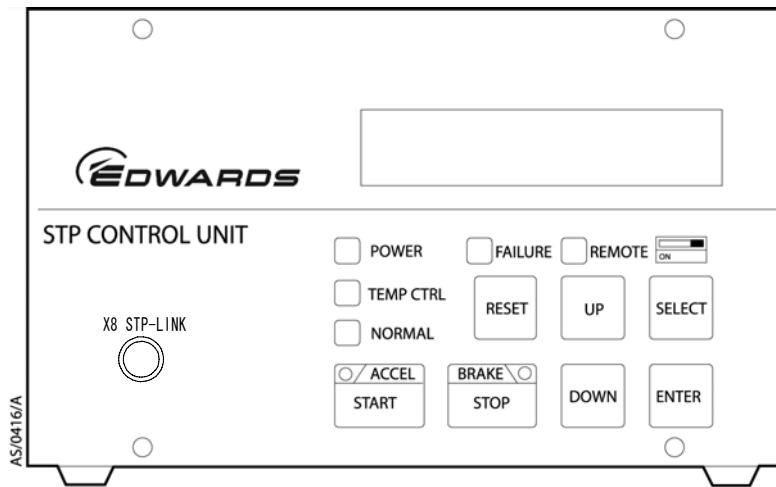

Figure 7 - SCU-1600 control unit

The following series of turbomolecular pumps can be used in conjunction with the SCU-1600.

Model Name	Specification
STP-A2203 series	Advanced high-throughput type
STP-A2503/A3003 series	Advanced high-throughput type
STP-A2803/A3503 series	Advanced high-throughput type
STP-F2203 series	High flow type
STP-XH2603/XH3203 series	Extreme hydrogen performance type
STP-XA2703/XA3203 series	Extreme advanced throughput type
STP-XA4503 series	Extreme advanced throughput type
STP-XW3503 series	High back pressures type

Table 1 - Turbomolecular pumps

## SCU-1600 Control Unit for Turbomolecular Pump

### 1.6.1 Cable sets

The following cable sets (optional accessories) are used with the SCU-1600 and STP pump:

- STP connection cable - STP pump to SCU-1600.
- TMS cable - STP pump to built-in TMS unit in the SCU-1600.
- Power cable - SCU-1600 to power supply.

*Note: Figure 8 shows a typical TMS system installation. System connections and cables differ according to the type of pump connected to the SCU-1600. Refer to the STP pump Instruction Manual (A) and (B) for full details of connection cables and system connections.*

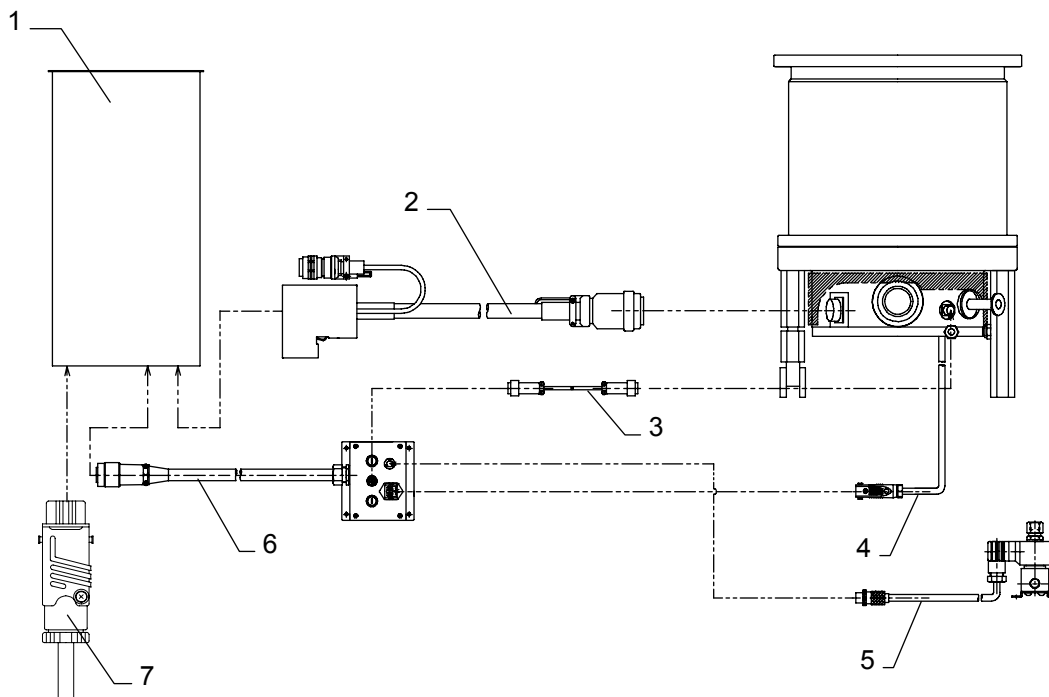

- |                         |                        |
|-------------------------|------------------------|
| 1 SCU-1600 control unit | 5 TMS valve cable      |
| 2 STP connection cable  | 6 TMS connection cable |
| 3 TMS sensor cable      | 7 Power cable          |
| 4 TMS heater cable      |                        |

Figure 8 - Configuration of the STP pump with the TMS



---

*SCU-1600 Control Unit for Turbomolecular Pump*

1

INTRODUCTION

This page intentionally blank

## 2 TECHNICAL DATA

### 2.1 SCU-1600 specifications

Applicable pump		STP-A2203 series STP-A2503/A3003 series STP-A2803/A3503 series STP-F2203 series STP-XH2603/XH3203 series STP-XA2703/XA3203 series STP-XA4503 series STP-XW3503 series
Input voltage:		200 to 240 Va.c $\pm$ 10%
Input power:	Without TMS unit With TMS unit	1500 VA maximum 2100 VA maximum
Input frequency		50/60 $\pm$ 2 Hz
Leakage current		3.5 mA maximum
Input phase		Single phase
Main breaker specification	Rated current Ampere Interrupting Capacity (AIC)	15 A 1000 A (240 Va.c., 50/60 Hz)
Motor driving system		3-phase d.c. brushless motor driver
Output voltage under normal operation		80 Va.c. maximum
Output frequency under normal operation		550 Hz maximum
Allowable ambient temperature		0 to 40 °C (32 to 104 °F)
Storage temperature		-25 to 55 °C (-13 to 131 °F)
Mass (except the optional accessory)		11 kg (24.2 lb)
Dimensions		Refer to Figure 9
Housing <sup>*1</sup>	Material Surface treatment	SPCC Trivalent chromate

<sup>\*1</sup> Irregular color or small scratches may appear on the housing in the metal plate processing of the manufacturing process. This is no abnormality.

**SCU-1600 Control Unit for Turbomolecular Pump**

TMS control unit		Built in
Battery for clock function	Specification Model Maker	Lithium battery (3 V, 130 mAhr) DS9034PCX MAXIM
Serial communication function		RS232/RS485
Operation switch	START STOP RESET SELECT UP DOWN ENTER MANUAL/REMOTE changeover	(Push-button switch•Green) (Push-button switch•Dark Grey) (Push-button switch•Grey) (Push-button switch•Grey) (Push-button switch•Grey) (Push-button switch•Grey) (Push-button switch•Grey) (Push-button switch•Grey) (Slide switch•White)
Panel indication LED	ACCEL. NORMAL BRAKE TEMP CTRL POWER FAILURE REMOTE	(Green LED) (Green LED) (Green LED) (Green LED) (Green LED) (Red LED) (Green LED)
Panel display	LCD	(2 lines of 20 characters)
Input/Output terminal	AC POWER X2 P.CONNECTOR X1 MOTOR X4 TMS X5 REMOTE X7 COM X3A/X3B STP-LINK X8	(3 pins) (60 pins) (8 pins) (26 pins) (37 pins) (9 pins × 2) (8 pins)
Safety function	Electromagnetic bearing failure detection STP pump overheat detection Motor driver overload detection Power failure detection STP pump overspeed detection STP control unit overheat detection TMS unit failure detection Other failure detection	

SCU-1600 Control Unit for Turbomolecular Pump

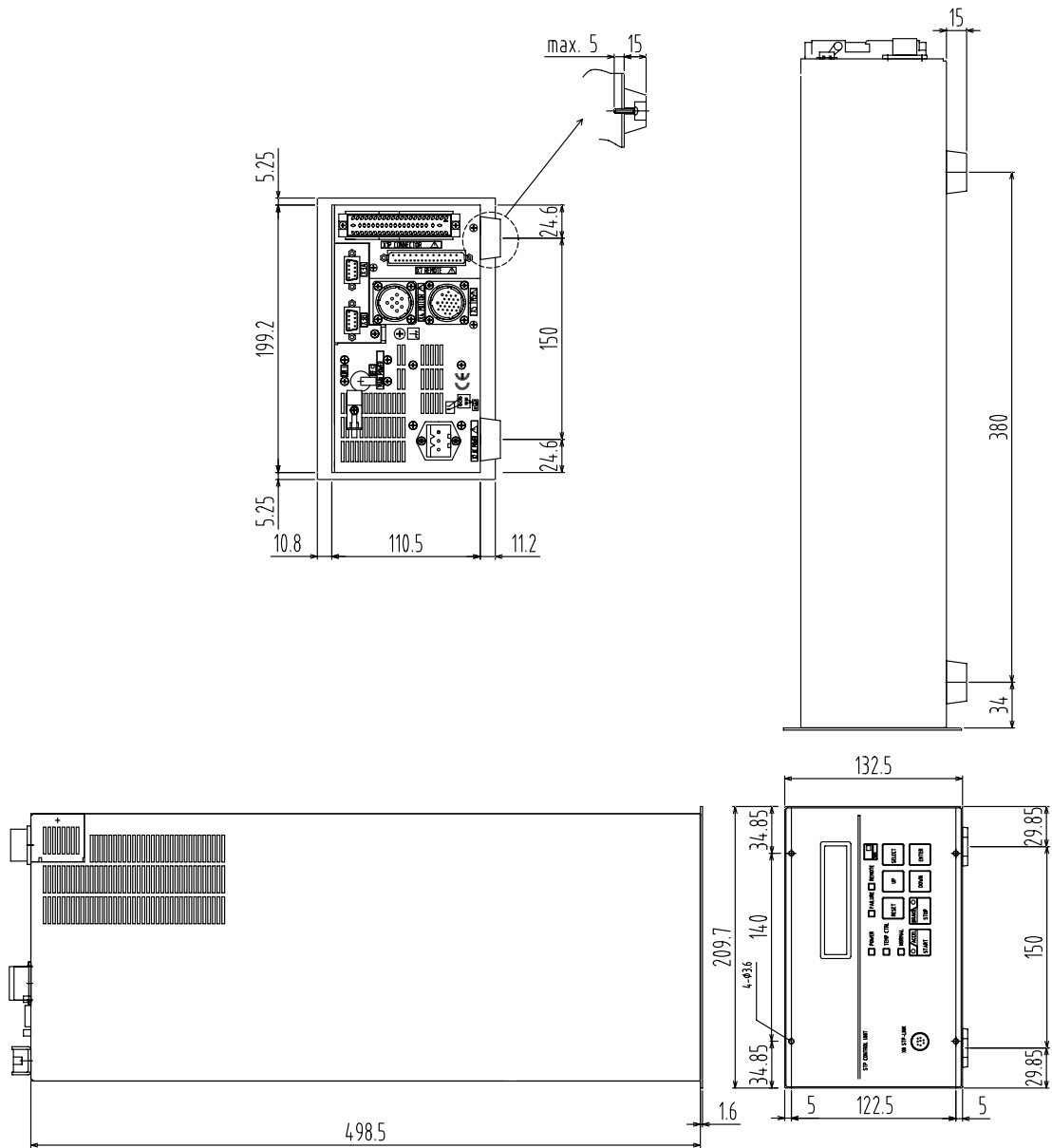

Figure 9 - SCU-1600 dimensions (mm)

Note: The screw hole sizes for the rubber feet and rack fixation are M4×12.



*SCU-1600 Control Unit for Turbomolecular Pump*

This page intentionally blank.



### 3 INSTALLATION

#### 3.1 Unpacking

Check outer package for damage and that the delivery note corresponds to the purchase order.

*Note: It is recommended to keep the packaging materials, such as the corrugated fibreboard container and cushioning material for possible re-use. If the SCU-1600 is damaged, return it in its original package and contact Edwards or their distributor.*

#### 3.2 Front panel

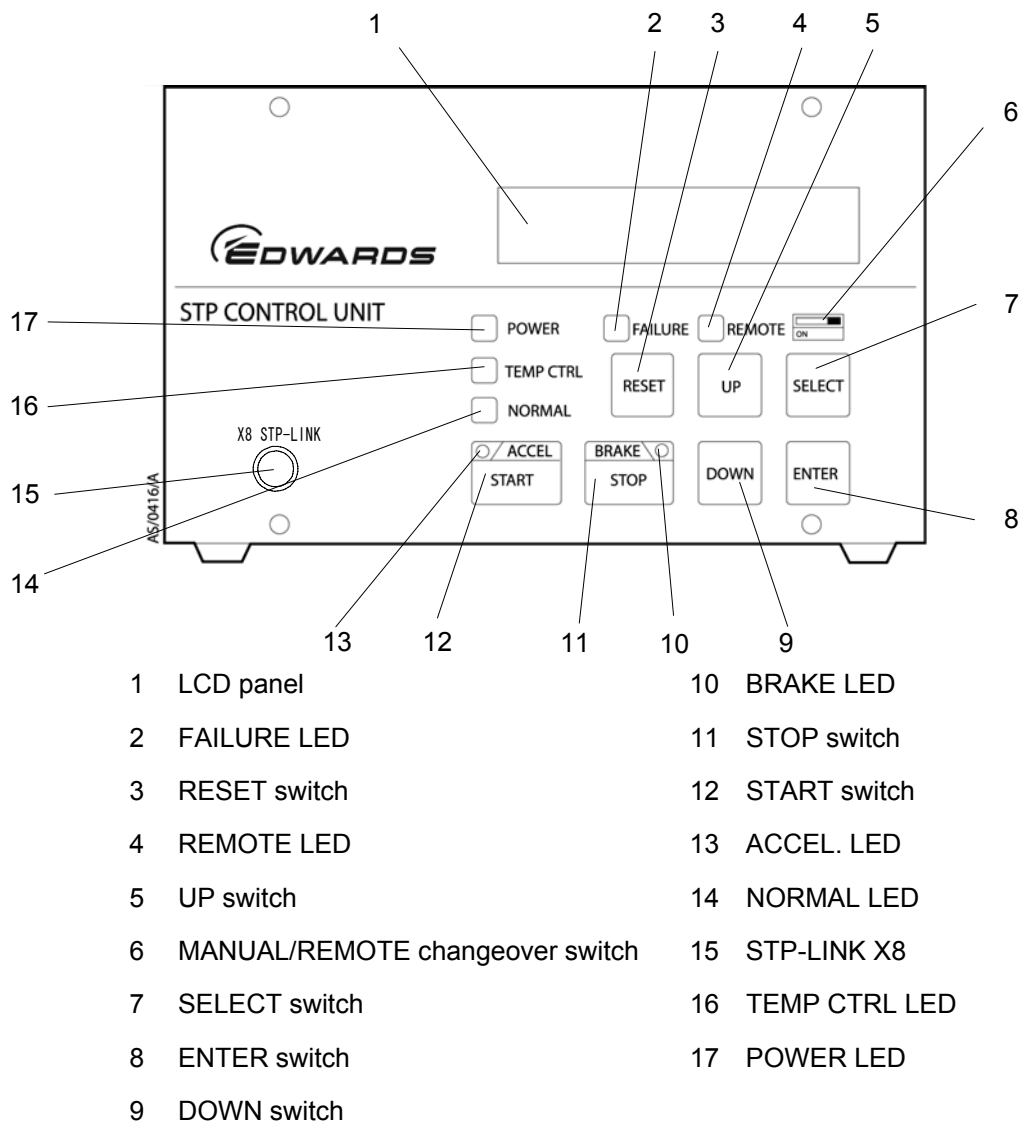

Figure 10 - SCU-1600 front panel

*Note: Refer to Table 2 for front panel functions.*



SCU-1600 Control Unit for Turbomolecular Pump

Item	Description	Function
1	LCD panel	Displays the STP pump's operational status, speed, error messages, and other.
2	FAILURE LED	(Red LED) Illuminates when an abnormality/error occurs on the STP pump or SCU-1600. LCD panel simultaneously displays an error message.
3	RESET switch	(Flat panel switch, grey. Valid in MANUAL only.) Alarm reset function. Tuning function.
4	REMOTE LED	(Green LED) Illuminates when in the REMOTE mode.
5	UP switch	(Flat panel switch, grey. Valid in MANUAL and REMOTE.) Abnormality/error display change function. Setting content confirmation function. Setting content change function.
6	MANUAL/REMOTE changeover switch	(Slide switch, white) Manual/Remote mode changeover.
7	SELECT switch	(Flat panel switch, grey. Valid in MANUAL and REMOTE.) LCD display function (Confirmation mode change and parameter set mode change). Press SELECT and UP switches simultaneously to enter the setting mode.
8	ENTER switch	(Flat panel switch, grey. Valid in MANUAL and REMOTE.) Setting content determination function. Warning message display function.
9	DOWN switch	(Flat panel switch, grey. Valid in MANUAL and REMOTE.) Abnormality/error display change function. Setting content confirmation function. Setting content change function.
10	BRAKE LED	(Green LED) Illuminates during STP pump deceleration (BRAKE state).
11	STOP switch	(Flat panel switch, dark grey. Valid in MANUAL only.) Stops the STP pump.
12	START switch	(Flat panel switch, green. Valid in MANUAL only.) Starts the STP pump.
13	ACCEL. LED	(Green LED) Illuminates during STP pump acceleration (ACCELERATION state).
14	NORMAL LED	(Green LED) Illuminates during STP pump rated speed operational (NORMAL OPERATION state).

Table 2 - SCU-1600 front panel functions



**SCU-1600 Control Unit for Turbomolecular Pump**

<b>Item</b>	<b>Description</b>	<b>Function</b>
15	STP-LINK X8	Connector for the dedicated cable (option) connection to do serial communication with the PC. Monitors the operating condition of the STP pump with the dedicated monitor software "STP-Link" (optional accessory) on the PC screen.
16	TEMP CTRL LED	(Green LED) illuminates when the TMS unit is (optional accessory) operational.
17	POWER LED	(Green LED) Illuminates when power is on. Extinguishes when backup power is being supplied.

Table 3 - SCU-1600 front panel functions (continued)

### SCU-1600 Control Unit for Turbomolecular Pump

#### 3.3 Rear panel

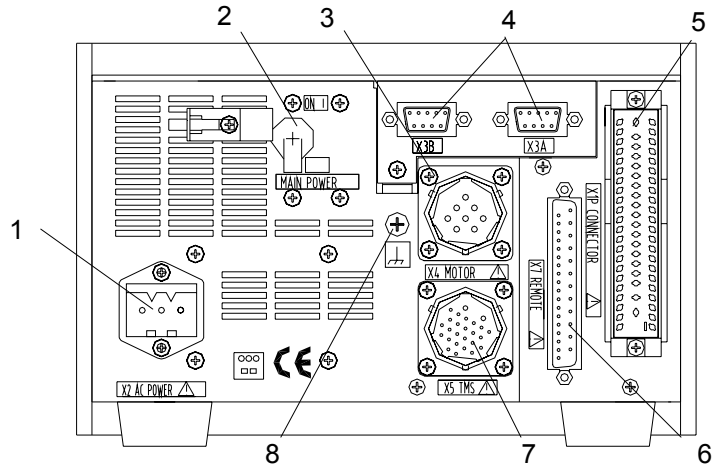

- |                             |                   |
|-----------------------------|-------------------|
| 1 AC POWER X2               | 5 P.CONNNECTOR X1 |
| 2 MAIN POWER breaker        | 6 REMOTE X7       |
| 3 MOTOR X4                  | 7 TMS X5          |
| 4 Serial port COM1 X3A, X3B | 8 Ground terminal |

Figure 11 - SCU-1600 rear panel

**WARNING**

A hazardous live voltage may exist at the connectors that are marked with the warning sign . DO NOT touch the terminal. Doing so may result in electric shock. When connecting/disconnecting the connector, always power off the SCU-1600 (turn the MAIN POWER "OFF") and isolate (Lockout/Tagout) the electrical energy source, water and gas, and other energy sources on the vacuum equipment.

Item	Description	Function
1	AC POWER X2	Main power connection (240 Va.c. maximum)
2	MAIN POWER breaker	Main power circuit breaker
3	MOTOR X4	STP motor connection (80 Va.c. maximum)
4	Serial Port COM1 X3A/X3B	Serial communication connection RS232/RS485 (shard use)
5	P.CONNNECTOR X1	STP pump connection (58 Va.c. maximum)
6	REMOTE X7	Remote connection (125 Va.c. maximum) RS485 serial communication (COM2)
7	TMS X5	TMS unit connection (240 Va.c. maximum)
8	Ground terminal	Ground (Earth) connection terminal

Table 4 - SCU-1600 rear panel connection

**SCU-1600 Control Unit for Turbomolecular Pump**

**3.4 Precautions before installation**

**CAUTION**

DO NOT move the STP pump and the STP control unit while the STP pump is in operation. Doing so may result in product damage.

**CAUTION**

Fasten the STP control unit to a rack to prevent a falling accident caused by earthquake.

**3.4.1 Operating environment**

The SCU-1600 should be installed in an area which meets the following requirements. Be sure the ambient temperature of the control unit during STP pump operation:

Ambient temperature	0 to 40 °C (32 to 104 °F)
Ambient relative humidity	30 to 95 % (non condensing)
Environment	An area free of exposure to direct sunlight, high humidity, dust, salty air, dripping water, explosive or flammable gas, corrosive gas, radiation, strong magnetic and electric fields, excessive vibration and sources of electric noise
Installation condition	Install and anchor the SCU-1600 horizontally (within ±10 degrees)

**3.4.2 Insulation test**

**CAUTION**

The varistor for the power supply line protection is installed in the SCU-1600. DO NOT perform the insulation test with the varistor installed. Doing so may result in product damage.

DO NOT perform an insulation test on the SCU-1600. When performing the insulation test on your equipment, ensure that you disconnect the SCU-1600 from the equipment that is to be insulation tested, so that the test voltage is not applied to the SCU-1600.

SCU-1600 Control Unit for Turbomolecular Pump

3.4.3 Installation area

CAUTION

The minimum bending radius of the STP connection cable is 100 mm (4"). DO NOT bend the cables excessively and beware of any obstacles when installing the SCU-1600. In addition, leave enough space to install other cables without bending them excessively.

When installing the SCU-1600, leave enough space for the following (refer to Figure 12):

- Space for maintenance and inspection.
- Space for inlet and outlet cooling air:  
Top and side: 50 mm (1.97") or more.  
Bottom: 15 mm (0.6") or more (height of the rubber feet).
- Space for connecting the cables:  
Rear: 210 mm (8.4") or more.

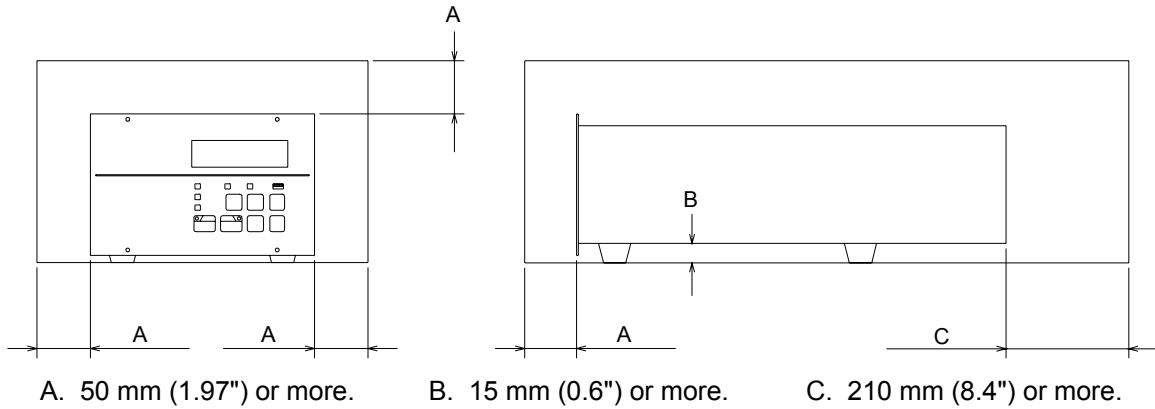

Figure 12 - Installing the SCU-1600

### SCU-1600 Control Unit for Turbomolecular Pump

#### 3.5 Attaching the SCU-1600 to a rack

##### CAUTION

The SCU-1600 cannot be supported with only the 4 screws on the front panel. Always support it from the bottom using a support angle. When installing the SCU-1600, DO NOT block the ventilation port of the SCU-1600 by the support angle or other things. It will cause the SCU-1600 to overheat.

The dimensions of the SCU-1600 front panel conform to EIA standards. Therefore, this panel can be attached to any type of commercially available rack. Attach the SCU-1600 as follows:

*Note:* For the dimensions of the front panel and positions of the screw holes for the rubber feet, refer to Figure 9 and Figure 13.

- Attach the front panel to the rack using the 4 screws Figure 13 (1).
- Support the SCU-1600 from the bottom using a support angle Figure 13 (2) or a similar tool.
- When attaching the SCU-1600 to a movable rack, to protect the SCU-1600 during transport, remove the rubber feet from the bottom and attach the SCU-1600 to the rack using the screw holes for the rubber feet.

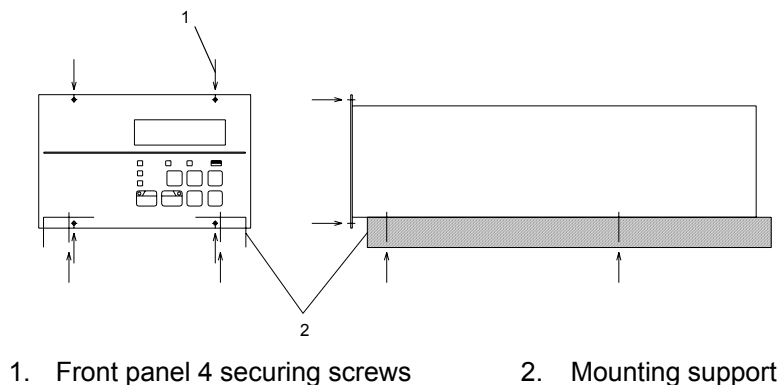



1. Front panel 4 securing screws      2. Mounting support

Figure 13 - Example of securing the SCU-1600

### SCU-1600 Control Unit for Turbomolecular Pump

#### 3.6 Cable connection

	<p style="text-align: center;"><b>WARNING</b></p> <p>When connecting/disconnecting cables, always power off the STP pump (switch the SCU-1600 MAIN POWER to "OFF") and isolate (Lockout/Tagout) the electrical energy source, water and gas, and other energy sources on the vacuum equipment. Failure to do so may result in the inadvertent rotation of the STP pump which may result in an accident, an electric shock or damage to equipment. An accident caused by water leaks or gas leak may occur.</p>
---	--

	<p style="text-align: center;"><b>WARNING</b></p> <p><b>DO NOT</b> remove the connector while the pump is rotating. The voltage might be output to connector according to the rotational speed, and it causes the electric shock or the failure.</p>
---	--

<p style="text-align: center;"><b>CAUTION</b></p> <p>Use the STP connection cable and the power cable that Edwards has specified. The use of other cables may result in product damage. Align the position of the guide key of the connectors and insert vertically so as not to bend the pins. If a pin is bent, not only may the connector not function normally, but it may make the pins contact, resulting in a malfunction. Lock and securely tighten each connector and screw.</p>
---

<p style="text-align: center;"><b>CAUTION</b></p> <p>Connect each cable securely with caution, avoiding any obstacles. <b>DO NOT</b> place heavy objects on the cables or bend them excessively. Support each cable so as not to apply direct force to the connectors or terminals. If any problem occurs in cables, connectors or terminals, the STP pump may not function normally. <b>DO NOT</b> apply voltage to each connector pin and <b>DO NOT</b> cause any short-circuiting between pins. Install cables so that personnel are not exposed to risk of tripping or falling.</p>
---



**SCU-1600 Control Unit for Turbomolecular Pump**

**3.6.1 STP connection cable**

Connect the receptacle (socket) side of the STP connection cable to the STP connector on the STP pump and connect the plug (pin) side to "P.CONNECTOR X1" and "MOTOR X4" on the SCU-1600.

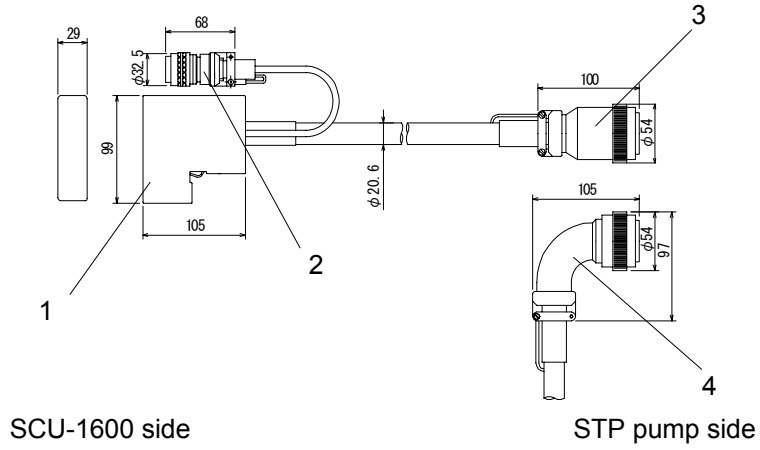

- 1 60 pin (pin)    2 8 pin (pin)    3 60 pin (socket)    4 60 pin (socket, L-Type connector)

Figure 14 - STP pump connection cable

### SCU-1600 Control Unit for Turbomolecular Pump

#### 3.6.2 TMS connection cable

Connect the plug (pin) side of the TMS connection cable to the "TMS X5" of the TMS control unit.

The SCU-1600 TMS unit is used with specified STP pumps. Refer to the STP pump Instruction Manual (B) for the cable connection method.

*Note: Figure 15 to Figure 17 show typical TMS cables. For details of the TMS cable used with the connected pump module, refer to the STP pump Instruction Manual (B).*

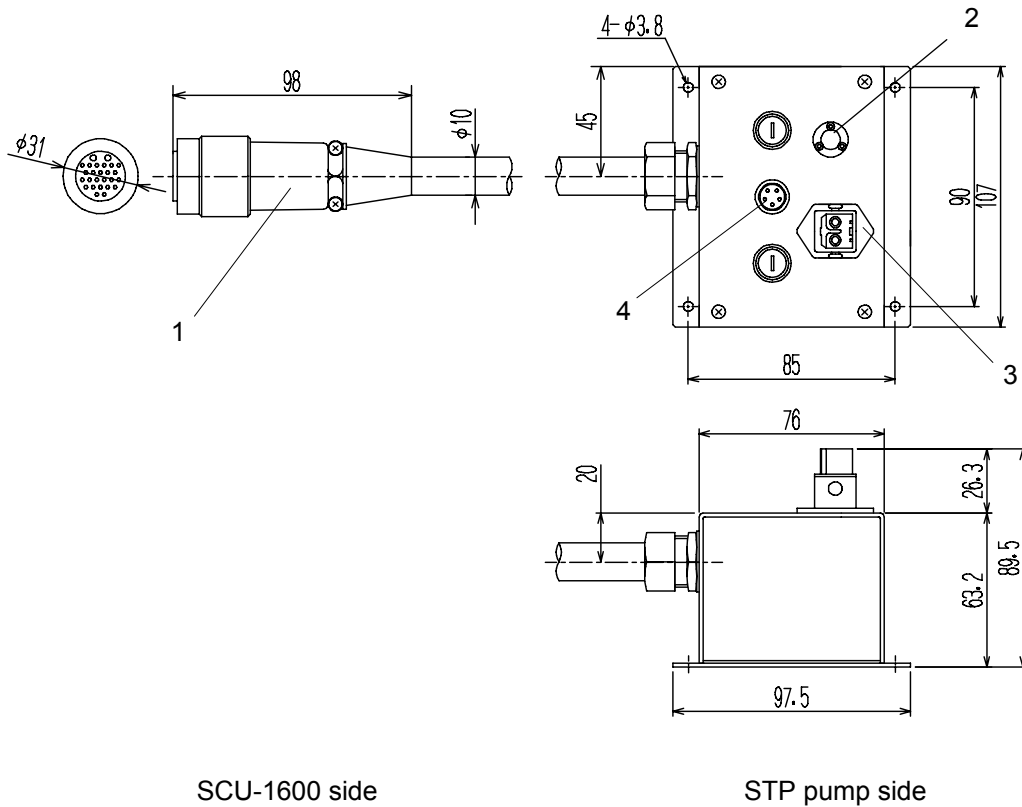

SCU-1600 side

STP pump side

- 1 SCU-1600 connection
- 2 TMS valve cable connection
- 3 TMS heater cable connection
- 4 TMS sensor cable connection

Figure 15 - TMS connection cable (with distribution box)

**SCU-1600 Control Unit for Turbomolecular Pump**

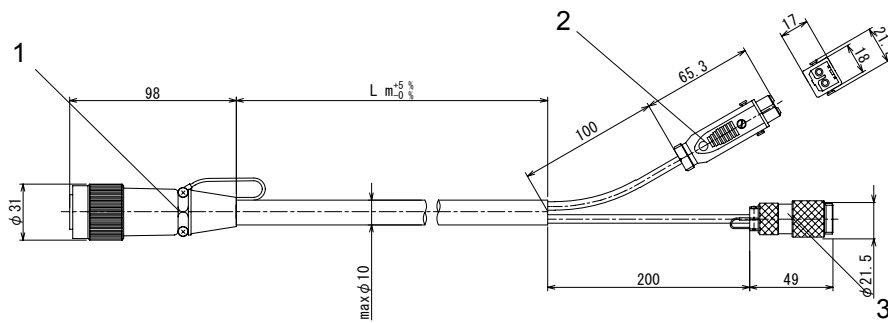

SCU-1600 side

STP pump side

- 1 SCU-1600 connection
- 2 TMS heater cable connection
- 3 TMS valve cable connection

Figure 16 - TMS connection cable (without sensor cable)

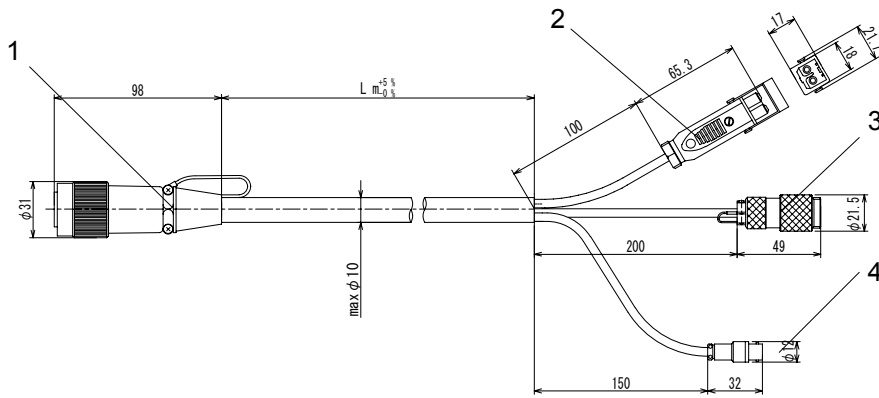

SCU-1600 side

STP pump side

- 1 SCU-1600 connection
- 2 TMS heater cable connection
- 3 TMS valve cable connection
- 4 TMS sensor cable connection

Figure 17 - TMS connection cable (with sensor cable)

SCU-1600 Control Unit for Turbomolecular Pump

3.6.3 Power cable

	<p><b>WARNING</b></p> <p>Ensure that the SCU-1600 and the electrical supply cable are suitably protected against earth (ground) faults and that the earth (ground) of the SCU-1600 and "AC POWER X2" are correctly connected.</p>
--	---

<p><b>CAUTION</b></p> <p>The power cable is designed specifically for the STP pump. DO NOT use the power cable with other products.</p> <p>Connect the power cable securely to prevent any poor or cross connections. DO NOT apply voltages exceeding 1 kV to the input line.</p> <p>Ensure that the supply voltage is as indicated on the SCU-1600 information label. Connect the power cable to the "AC POWER X2" connector on the SCU-1600.</p>
--

Connect the power cable for the SCU-1600 side to the "AC POWER X2" on the SCU-1600 rear panel as shown in Table 5.

Connect the suitable connector to the power supply as shown in Table 5.

Connect the power cable to the main power of the vacuum equipment via a circuit breaker (rated current 15 A).

When using the power cable without plug, connect, connect the primary power to the UL-recognized terminal block of the vacuum equipment. Secure the terminals with M4-bolts as the other side of the terminals, and cover the terminal block with an appropriate cover. (refer to Figure 20)

*Note: The STP connection cable and primary power cable are not included. Contact the distributor to purchase.*

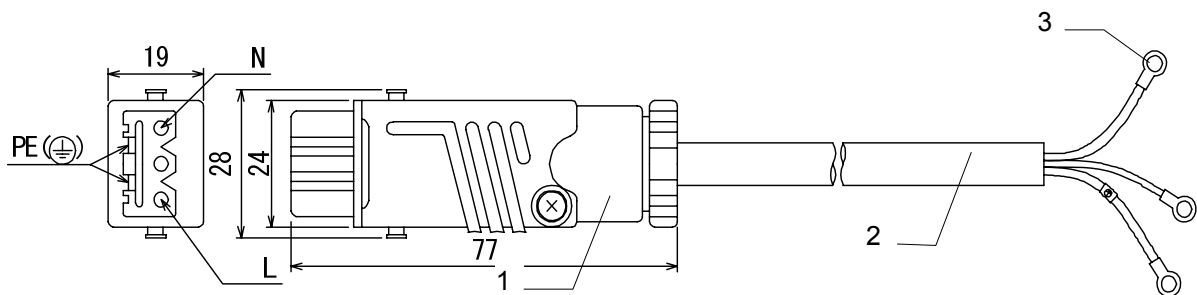

- |  |                             |
|--|-----------------------------|
| <p>SCU-1600 side</p> <p>1 3 pin (socket)</p> <p>2 2.5 mm<sup>2</sup> (AWG 14) × 3 cores, φ 9.6 to φ 10.1 mm<br/>Cable color: Brown, Blue, Yellow/Green or Black1, Black2, Yellow/Green</p> <p>3 Crimp-type terminal (M4)</p> | <p>Power side (Primary)</p> |
|--|-----------------------------|

Figure 18 - Power cable (without plug)

SCU-1600 Control Unit for Turbomolecular Pump

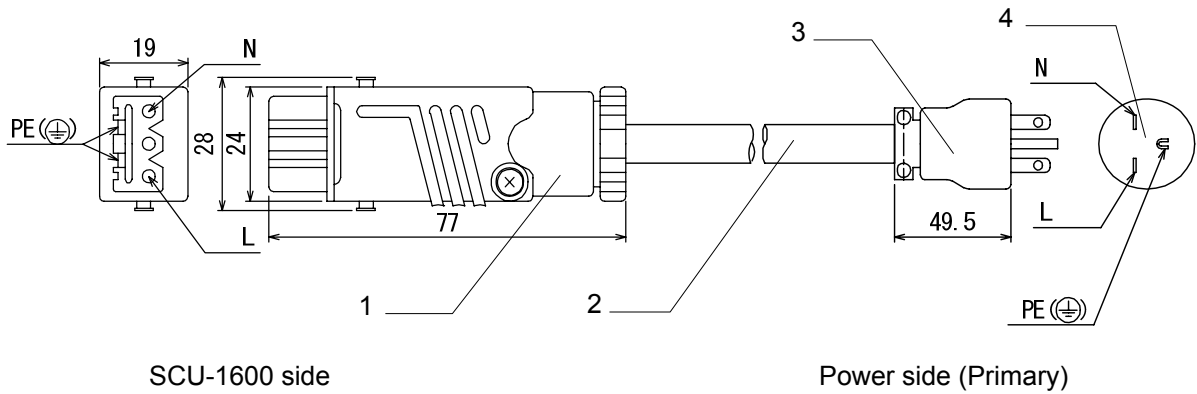

SCU-1600 side

Power side (Primary)

- 1 3 Pin (socket)
- 2 2.5 mm<sup>2</sup> (AWG 14) × 3 cores, φ 9.6 to φ 10.1 mm  
Cable color: Brown, Blue, Yellow/Green or Black1, Black2, Yellow/Green
- 3 3 Pin (pin)
- 4 Plug type NEMA6-15

Figure 19 - Power cable (with plug)

CON1 pin	Cable Colour	Remarks
L	Brown or Black 1	Single-phase 200 to 240 Va.c. 50/60 Hz
N	Blue or Black 2	
PE (⊥)	Yellow/Green	Earth (ground)

Table 5 - Power cable

SCU-1600 Control Unit for Turbomolecular Pump

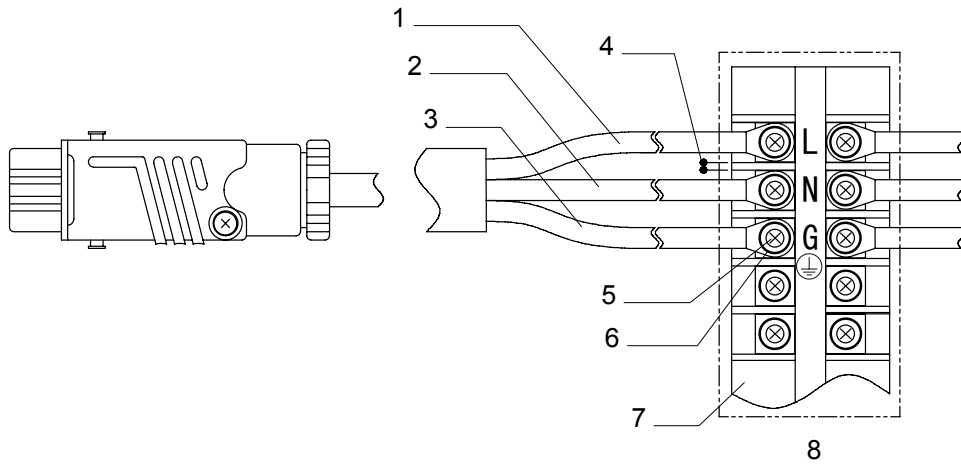

SCU-1600 side

Power side (Primary)

- |   |                             |   |                              |
|---|-----------------------------|---|------------------------------|
| 1 | Brown or Black <sup>1</sup> | 5 | M4-bolt (fixing screw)       |
| 2 | Blue or Black <sup>2</sup>  | 6 | Crimp-type terminal (M4)     |
| 3 | Yellow/Green                | 7 | Cover <sup>*1</sup>          |
| 4 | Clearance min. 1.5 mm       | 8 | Terminal block <sup>*2</sup> |

<sup>\*1</sup> Use material flammability: UL 94V-0

<sup>\*2</sup> Use the UL-recognized terminal block satisfying with the following conditions;

- a) Clearance (between each terminal): 1.5 mm or more
- b) Material flammability: UL 94V-0
- c) The installation category II .

Figure 20 - Connecting method of the power cable without plug

## SCU-1600 Control Unit for Turbomolecular Pump

### 3.7 Connecting to semiconductor equipment

The STP pump is a component system when installing to the semiconductor equipment. Consider the following when designing the semiconductor equipment.

#### 3.7.1 Connecting to power

The SCU-1600 receives its power from the semiconductor equipment electrical distribution system via a circuit breaker (rated current 15 A).

Electrical energy isolation (Lockout/Tagout) is achieved by opening the main disconnect device or circuit breaker of the semiconductor equipment, thereby removing power from the STP pump.

Provide the equipment with the main disconnect or circuit breaker devices rated for at least 10,000  $A_{rms}$  symmetrical amperes interrupting capacity (AIC).

#### 3.7.2 Emergency off circuit (EMO circuit)

Activation of EMO circuit of the equipment will interrupt electrical power from the SCU-1600.

When the power is shut off, the STP pump performs the same as a power failure. (After backup operation of a power failure, the rotor lands on the touch down bearing)

Consider the following when establishing the EMO circuit.

#### CAUTION

Unite the exhaust gas system to prevent atmosphere from being introduced into the STP pump when the EMO circuit operates (example: shut the valve). When atmosphere is introduced into the STP pump, the touch down bearing may not operate normally.

#### CAUTION

The STP pump rotates for a while after the EMO circuit shuts off the power. Perform a recovery operation after the STP pump has stopped completely.

#### CAUTION

Before performing the operation check of the EMO circuit with regular maintenance, stop the STP pump to prevent damage to the touch down bearing.

*Note: Procure the main disconnect device and the EMO circuit at your company.  
Use the main disconnect device which is lockable only in the de-energised position.  
Locate the main disconnect device and the EMO button in the place where personnel are readily accessible and are not exposed to any hazards during operation.*

**SCU-1600 Control Unit for Turbomolecular Pump**

**3.8 Remote communication**

**3.8.1 Parallel communication**

The SCU-1600 is fitted with a remote communication port, "REMOTE X7" (refer to Figure 21) to allow remote input and output signal control via input and output remote signals. This connector is a D-Sub type (37-pins, socket) that conforms to MIL-C-24308. The screw for connector is M2.6.

*Note: This D-Sub type connector is not supplied. Procure the connector for remote connection at your company.*

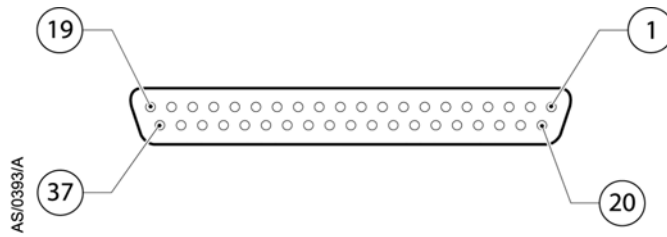

Figure 21 - REMOTE X7 connector

**3.8.2 Serial communication**

The SCU-1600 is fitted with a remote communication port, "Connector X3A, X3B" (refer to Figure 22) to allow remote input and output signal control by serial protocol. This connector is a D-Sub type (9-pins, socket) that conforms to MIL-C-24308. The screw for connector is M2.6.

*Note: This D-Sub type connector is not supplied. Procure the connector for remote connection at your company.*

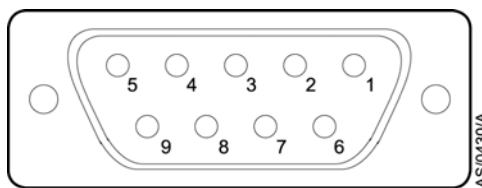

Figure 22 - Connector X3A, X3B (D-sub 9)



### 3.9 Adjustment methods

#### 3.9.1 Tuning

Tuning is required to align the position of levitation in the STP pump axial direction with the centre of the rotor's movable range. Tuning can be performed simply by pressing the "RESET" switch on the front panel (refer to Figure 10).

Tuning is required in the following cases in which the position of levitation may deviate from the centre of the rotor's movable range:

- When purchasing only the SCU-1600 and connecting to the STP pump for the first time.
- When changing the length of the STP connection cable (not when changing the length of the power cable).
- Connecting the same model but a different serial number of the STP pump to the SCU-1600 after the tuning is performed. (The error message "CAUTION : Coupling is Changed" is displayed upon performing the self test)
- Connecting a different model of the STP pump to the SCU-1600 after the tuning is performed. (The error message "CAUTION : Pump Type is Changed" is displayed upon performing the self test)

#### 3.9.2 Tuning method

Refer to Figure 23.

1. Ensure all cables are connected.
2. Turn "ON" the MAIN POWER on the SCU-1600 rear panel.
3. After the STP pump completes the self test and "Levitation" is displayed, set the MANUAL/REMOTE changeover switch to the MANUAL and press the "RESET" switch on the front panel for approximately 3 seconds.
4. See Section 4.2.2, "Tuning Method when "CAUTION" Message is Displayed after the Self Test" when a "CAUTION" message is displayed during the autotest.
5. When the LCD displays "Tuning", release the "RESET" switch. The tuning is performed automatically.
6. Approximately 1 minute later the LCD displays "Tuning Complete", and then displays "Levitation". This completes the tuning.



### **SCU-1600 Control Unit for Turbomolecular Pump**

*Note: Tuning can be performed only while the STP pump is in the LEVITATION state. (It cannot be performed while the STP pump is in the ACCELERATION, NORMAL OPERATION, or BRAKE state)*

*When performing the tuning during remote operation, press the "RESET" switch on the front panel after switching the "REMOTE" switch to MANUAL. (The remote signal cannot be used for tuning)*

*Once tuning is completed, re-tuning is not required unless the configuration (the STP pump serial number, the SCU-1600 serial number, and the STP connection cable length) is changed.*

*Although the STP pump produces an abnormal noise during tuning, this is not an indication of abnormality.*

SCU-1600 Control Unit for Turbomolecular Pump

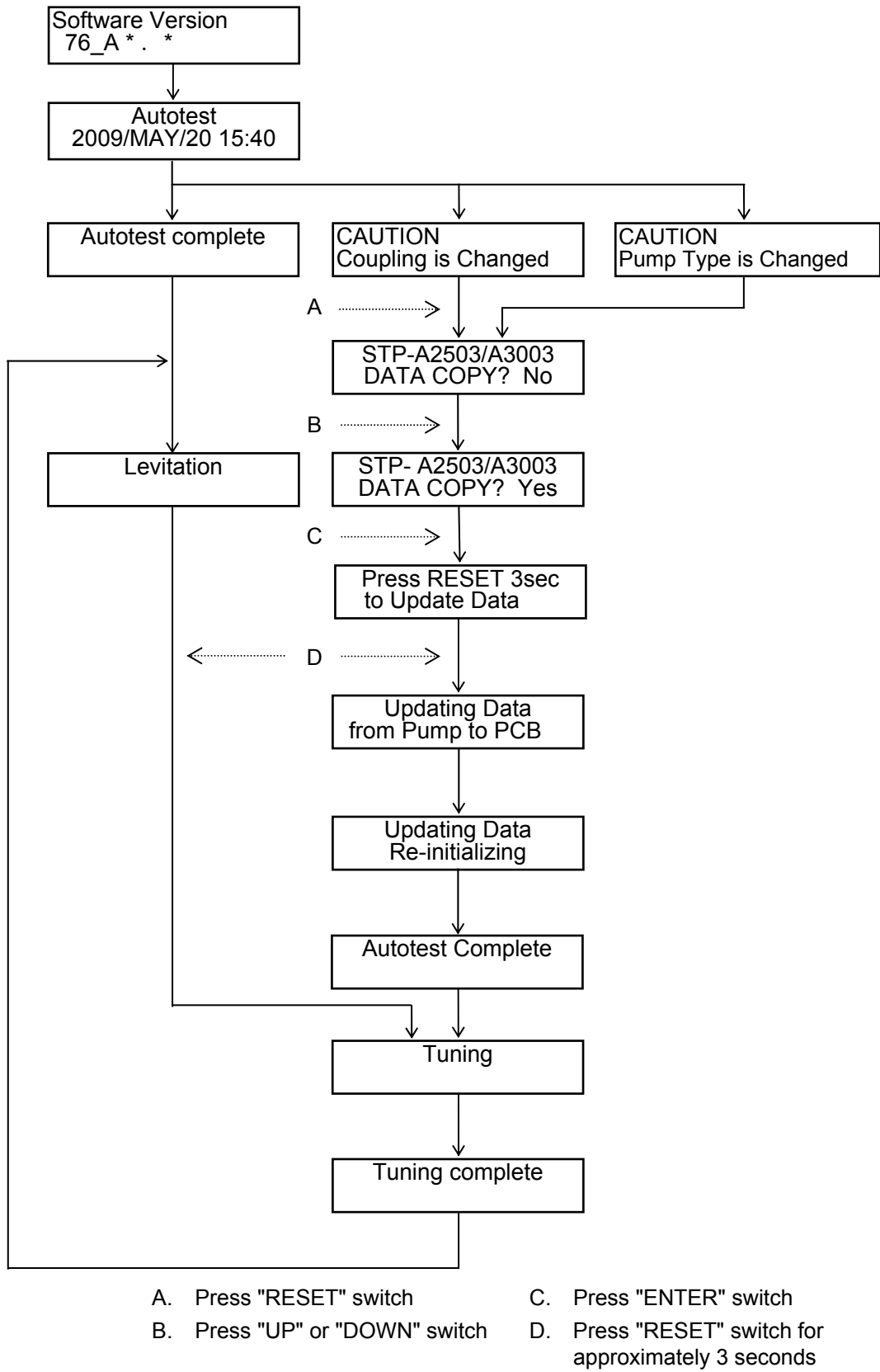

Figure 23 - Tuning procedures

**SCU-1600 Control Unit for Turbomolecular Pump**

**3.9.3 Change of data after tuning**

The user setting may be changed because of the change of the configuration of the STP pump and SCU-1600 after "CAUTION" message is displayed.

Confirm the setting shown in Table 6 after tuning, and reconfigure the setting when the user setting has changed.

For the setting confirmation, refer to Sections 3.10 and 3.11.

Items		Factory setting (reference)	Remarks
Remote mode		I/O Remote	
Rotational speed		Rated speed	Varies according to STP pump type.
Second speed		Half rated speed	Varies according to STP pump type.
TMS function		DISABLE	ENABLE (in the case of the TMS specification).
Inhibit function		DISABLE	
Second speed option		DISABLE	
Optional signal output (Emergency vent valve)		DISABLE	
Warning function	Damage point	ENABLE	
	Imbalance	ENABLE	
	Pump run time	DISABLE	
	Pump overload	DISABLE	
Serial port COM1, COM2	Baud rate	9600 bps	
	Bit length	8	
	Stop bit	1	
	Parity	None	
Serial port COM1 driver type		RS232	
Serial port COM2 driver type		RS485 Single	

Table 6 - User setting data list

### 3.10 Confirmation mode

Confirmation mode is used to check the status of the STP pump and SCU-1600. The following items can be checked in Confirmation mode:

1. Version information.
2. Individual information (serial number, total hours of running, number of starts and damage of the bearing).
3. Current settings (rotational speed, second speed, TMS temperature setting, actual pump temperature and actual motor current).
4. Current function settings (remote mode, TMS function, inhibit function, second speed option, optional output signal [can be used for emergency vent valve], imbalance warning function, pump runtime warning function, and pump overload warning function).
5. Error record (The control unit can store information about up to 10 of the most recent errors. "1/n" denotes the most recent error. While pressing "ENTER" switch, the time of errors occurrence is displayed).

#### 3.10.1 Confirmation method

Refer to Figure 24.

1. Press the "SELECT" switch to enter the Confirmation mode.  
The available menu groups (Section 3.10 steps (1) through (5)) are displayed in order.
2. Press the "UP" switch to display the next menu item. Press the "DOWN" switch to display the previous menu item.
3. Press the "SELECT" switch to display the next menu group.
4. Press the "UP" and "DOWN" switch to confirm the status of the items of the currently selected menu group.
5. Press the "SELECT" switch to return to Operation mode when viewing the Error Record.  
If no switch is pressed for approximately 1 minute, the display will automatically revert to Operation mode.

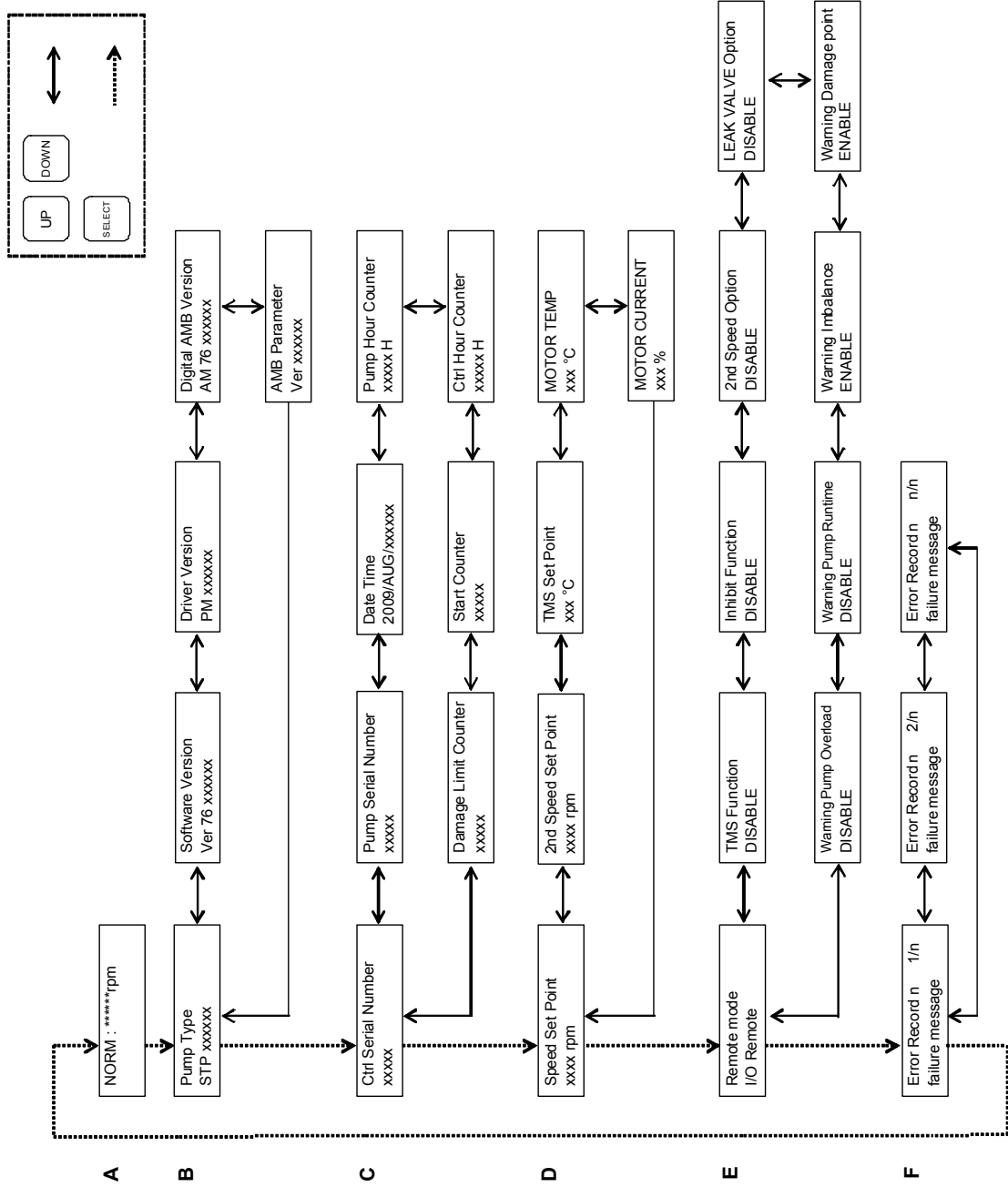

- A. Operation mode
- B. Version information
- C. Individual information
- D. Current settings
- E. Current function settings
- F. Error record

Figure 24 - Confirmation mode

### **3.11 Parameter set mode**

Parameter set mode is used to set the different parameters of the STP pump and SCU-1600.

#### **3.11.1 Remote operation setting**

The remote parallel port (I/O REMOTE), serial port COM1, serial port COM2, and STP-Link are fitted on the SCU-1600 as standard connectors for the remote operation. The hardware is selected for the remote operation setting of the start, stop and reset. Refer to Section 4.5 and Section 5 for the remote operating methods. The remote output monitoring the operating state can be output with any hardware.

#### **3.11.2 Rotational speed setting**

The rotational speed can be changed in units of 500 rpm in the NORMAL state. The variable range is from half of the rated speed to the rated speed. The rated speed is different according to the connected pump.

#### **3.11.3 TMS setting**

Enable/Disable the TMS control function.

#### **3.11.4 Rotational inhibit signal setting**

Enable/Disable the rotation inhibit signal.

#### **3.11.5 Second speed option setting**

Enable/Disable the second speed option. Second speed option and option signal setting cannot be enabled simultaneously.

#### **3.11.6 Second speed setting**

The second speed can be changed in units of 500 rpm. The variable range is from half of the rated speed to the rated speed. The rated speed is different according to the connected pump.



### *SCU-1600 Control Unit for Turbomolecular Pump*

#### **3.11.7 Optional output signal setting (Emergency vent valve setting)**

Enable/Disable the optional signal. When a failure of the magnetic bearing is detected, in the state of the emergency vent valve function is effective, the emergency vent valve operates. Disable the function when the emergency vent valve is not fitted on the STP pump connected to the SCU-1600. Second speed function and option signal setting cannot be enabled simultaneously.

#### **3.11.8 Second Damage Limit setting**

Enable/Disable the rotational operation after "Second Damage Limit" occurs. When setting to "ENABLE", "START NOT ALLOWED" is displayed and the rotational operation cannot be performed. When setting to "DISABLE", "Second Damage Limit" is displayed, though the rotational operation can be performed.



### 3.11.9 Warning function setting

Refer to Section 7.2, "WARNING Message Function" for the detail of the "WARNING" function.

#### 1. Warning Damage Point

Enable/Disable Damage limit of the bearing warning function.

When setting to "ENABLE" and the Damage limit of the bearing exceeds the setting value, a warning message is displayed.

#### 2. Warning Imbalance

Enable/Disable Imbalance warning function.

When setting to "ENABLE" and the Imbalance of the rotor exceeds the setting value, a warning message is displayed.

#### 3. Warning Pump Runtime

Enable/Disable warning function of the pump operation hours.

When setting to "ENABLE" and the operating hours exceeds the setting value, the warning message is displayed.

#### 4. Pump Runtime Set Point

Enable/Disable warning function of the pump operating hours in units of 100 hours. (up to 30 million hours)

#### 5. Warning Pump Overload

Enable/Disable overload warning function of the pump.

When setting "ENABLE" and the state for the motor current of the STP pump continues exceeding or dropping below the setting value, the warning message is displayed.

#### 6. Current Ceiling Rate

Sets the motor current of the overload warning function of the pump.

The rated speed (max. current) is as 100%. It can be set from 0 to 100 %. The smaller current setting value is given "WARNING" because the warning occurs when the pump overloads and the motor current exceeds the setting value.

#### 7. Speed Floor Rate

Sets the rotational speed of the overload warning function of the pump.

The rated speed is as 100%. It can be set from 0 to 100 %. The bigger rated rotational speed setting value is given "WARNING" because the warning occurs when the pump overloads and the rated speed drops below the setting value in NORMAL state.

### 3.11.10 Serial port COM1 setting

1. Baud rate  
Set the communication speed. Maximum 56,000 bps can be set.
2. Bit length  
Set the bit number of the communication data to 7 or 8.
3. Stop bit  
Set the stop bits number to 1 or 2.
4. Parity  
Presence or absence of parity check. In the case of presence, select even number or odd number.
5. Driver type  
Set to either the RS232, RS485 Single or RS485 Multipoint.
6. RS485ID  
Set the identification number in the RS485 Multipoint. (1 to 127)

### 3.11.11 Serial port COM2 setting

Refer to 1 to 4, and 6 in Section 3.11.7, "Serial port COM1 setting".

5. Driver type  
Set the one of the RS485 Single or RS485 Multipoint.

### 3.11.12 Date/Time setting

Set the present date/time in the built-in clock.

### 3.11.13 Factory setting

The set value of the factory setting is shown in Table 6.

### 3.11.14 Parameter setting procedure

Refer to Figure 25 to Figure 28.

1. Press the "UP" and "SELECT" switches simultaneously to enter the Parameter Set Mode. The setting options detailed from Section 3.11.1 to 3.11.12 is each displayed in order.
2. Press the "UP" switch to go to the next parameter, and press the "DOWN" switch to display the previous parameter.
3. Press the "ENTER" switch to set the new parameter and to enter the next menu. However, note that the new parameter is not accepted until it is stored (refer to step 6 below).
4. When the parameter is not required to be set, press the "SELECT" switch and go to the next menu.
5. Use the same procedure 1 to 4 above to set the remaining parameters.
6. "STORAGE NO" is displayed on the preservation menu. Select "YES" with the "UP" or "DOWN" switches and press "ENTER" to store the parameter. The message on the LCD displays "STORAGE IN PROGRESS" shown the storage state. Then the storage succeeds, "STORAGE OK" is displayed. However the storage fails, "STORAGE NOT OK" is displayed.
7. When pressing the "SELECT" switch in the state of "STORAGE NOT OK" displayed, the preservation is displayed. In this case, try to store it again.
8. Press the "ENTER" switch when the state "STORAGE OK" is displayed to enter the date/time setting menu. It is displayed as "2009/AUG/08 11 : 08 ENTER to adjust" on the LCD. Press "ENTER" switch to enter to the year setting menu. If you do not want to set the date, press the "SERECT" switch, and return to the operation mode.
9. The year can be changed with "UP" or "DOWN" switch. Press the "SELECT" or "ENTER" switch to enter the month setting menu. However, note that the change of year is not accepted yet.
10. Display the date, hour and the minute with the "SELECT" or "ENTER" switch. Set them with "UP" or "DOWN" switch.
11. The date/time and "ENTER to Cancel" are displayed on the confirmation menu. If you have made an error when setting, press the "ENTER" switch to return to the date/time setting menu in 8).
12. After confirming the date/time on the confirmation menu, select the "apply" and then press the "ENTER" switch.

*Note: If no switch is pressed for approximately 1 minute, the display will automatically revert to Operation mode. In this case, unsaved settings are not changed.*

### SCU-1600 Control Unit for Turbomolecular Pump

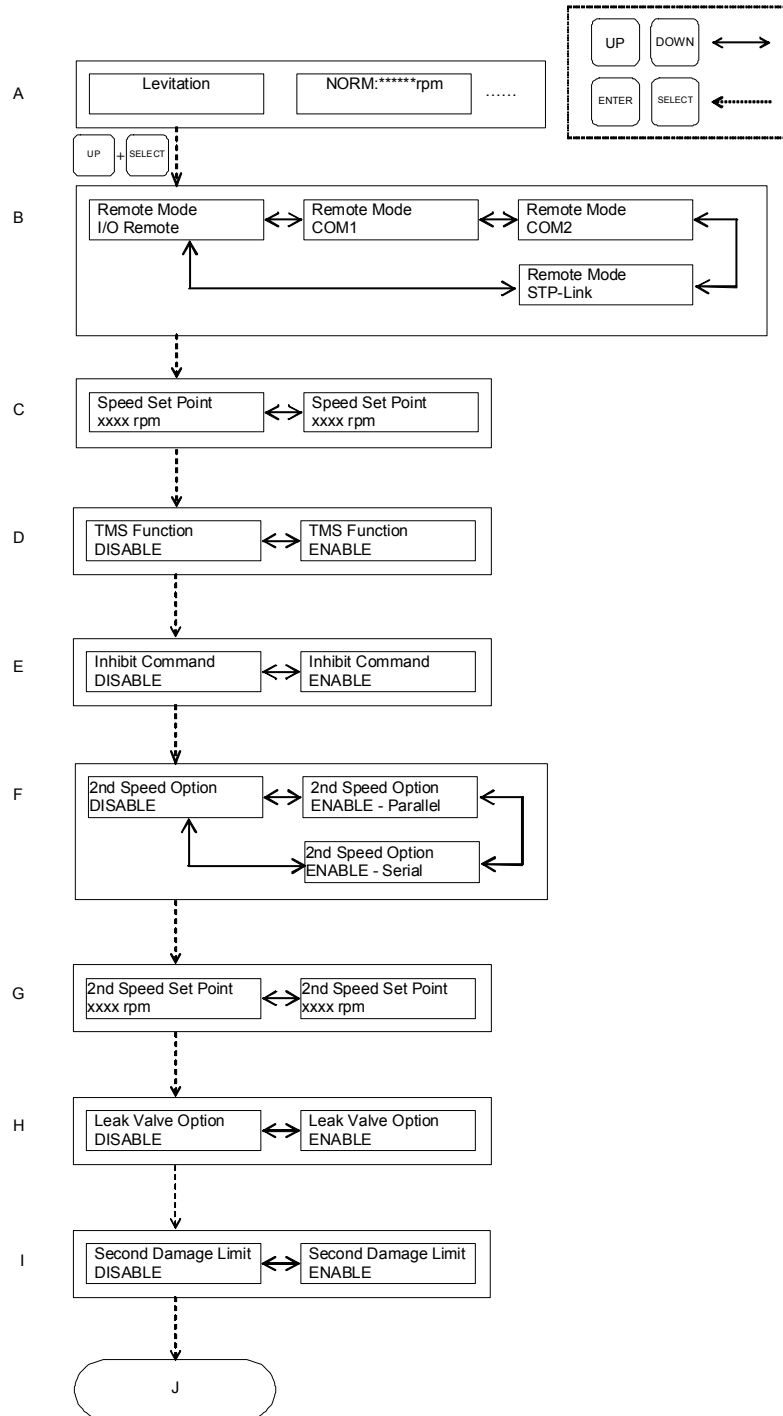

Figure 25 - Parameter setting method

- |                             |                                  |
|-----------------------------|----------------------------------|
| A. Operation mode           | F. Second speed function setting |
| B. Select remote mode       | G. Second speed setting          |
| C. Rated speed setting      | H. Emergency vent valve setting  |
| D. TMS function setting     | I. Second Damage Limit setting   |
| E. INHIBIT function setting | J. To Warning function setting   |

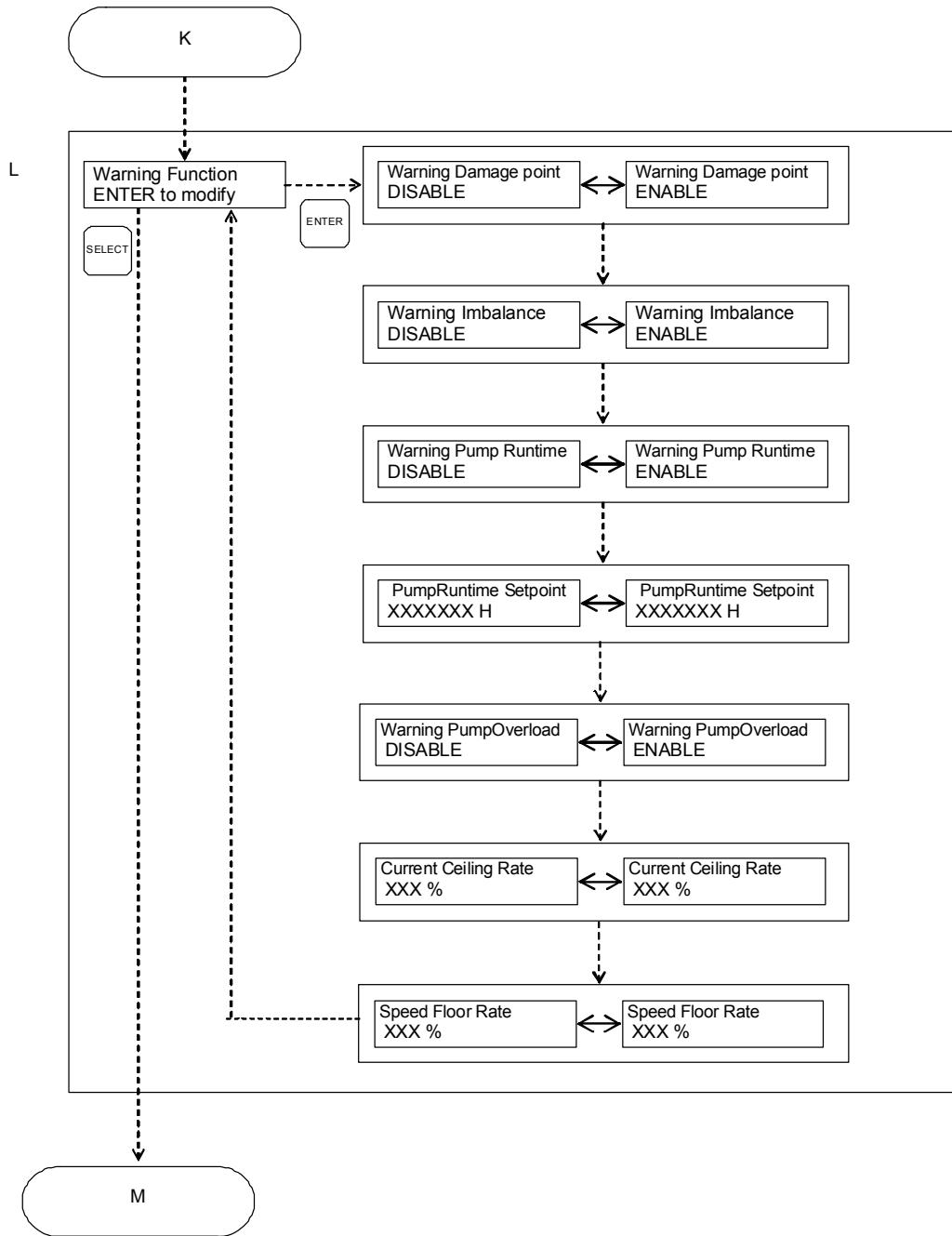

Figure 26 - Parameter setting method (continued)

- K. From Second Damage Limit setting
- L. Warning function setting
- M. To Serial port COM1 setting

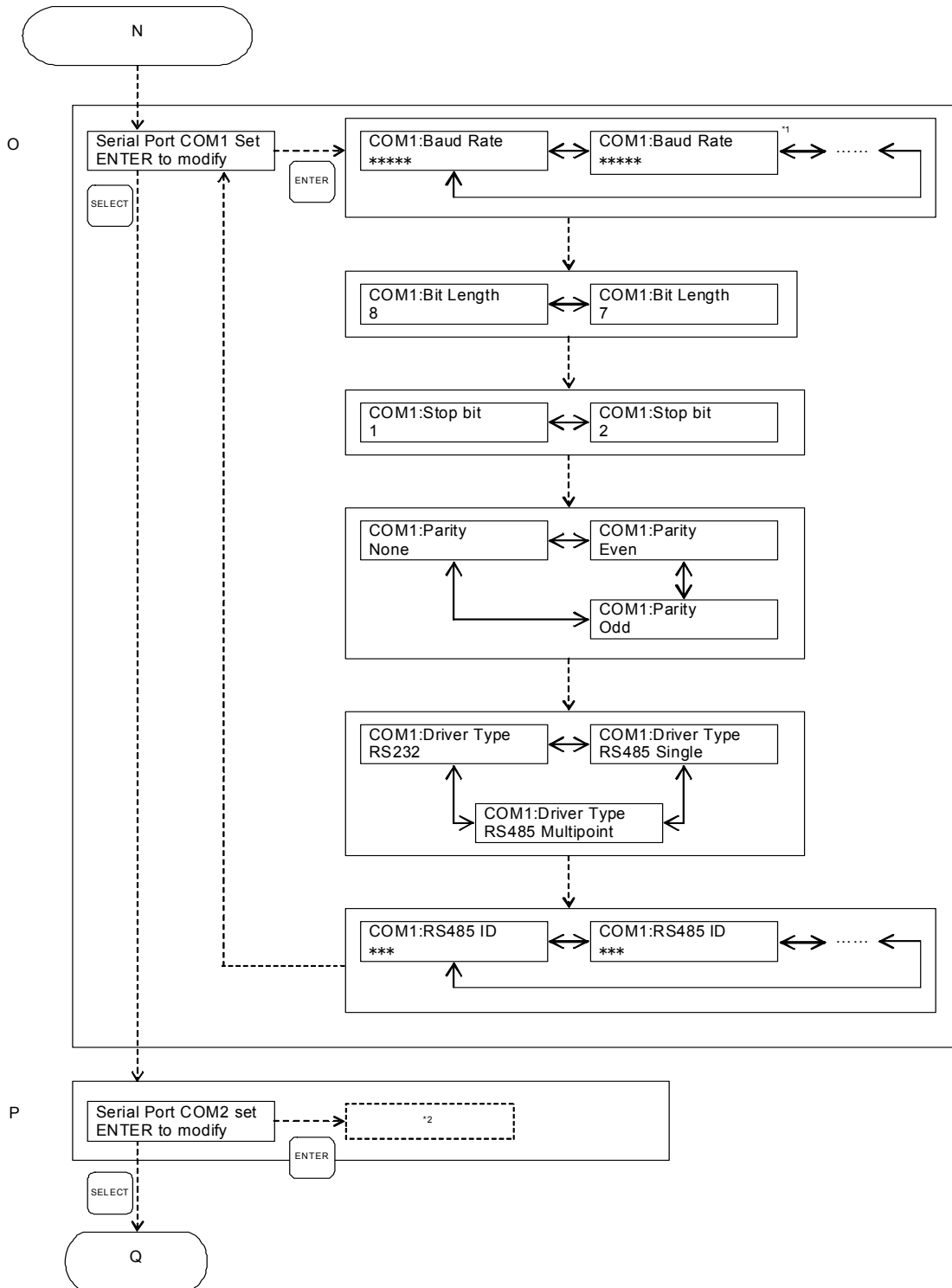

Figure 27 - Parameter setting method (continued)



## SCU-1600 Control Unit for Turbomolecular Pump

- N. From Warning function setting
- O. Serial port COM1 setting
- P. Serial port COM2 setting
- Q. To Storing display

<sup>\*1</sup> Available "Baud Rate" are 110, 300, 600, 1200, 2400, 4800, 9600, 14400, 19200, 28800, 38400, and 56000 bps. Available "RS485ID" is between 1 and 127.

<sup>\*2</sup> The Serial Port COM2 setting menu composition is the same as the Serial Port COM1 setting. Only "RS485 Single" and "RS485 Multipoint" are selectable to Driver Type.

SCU-1600 Control Unit for Turbomolecular Pump

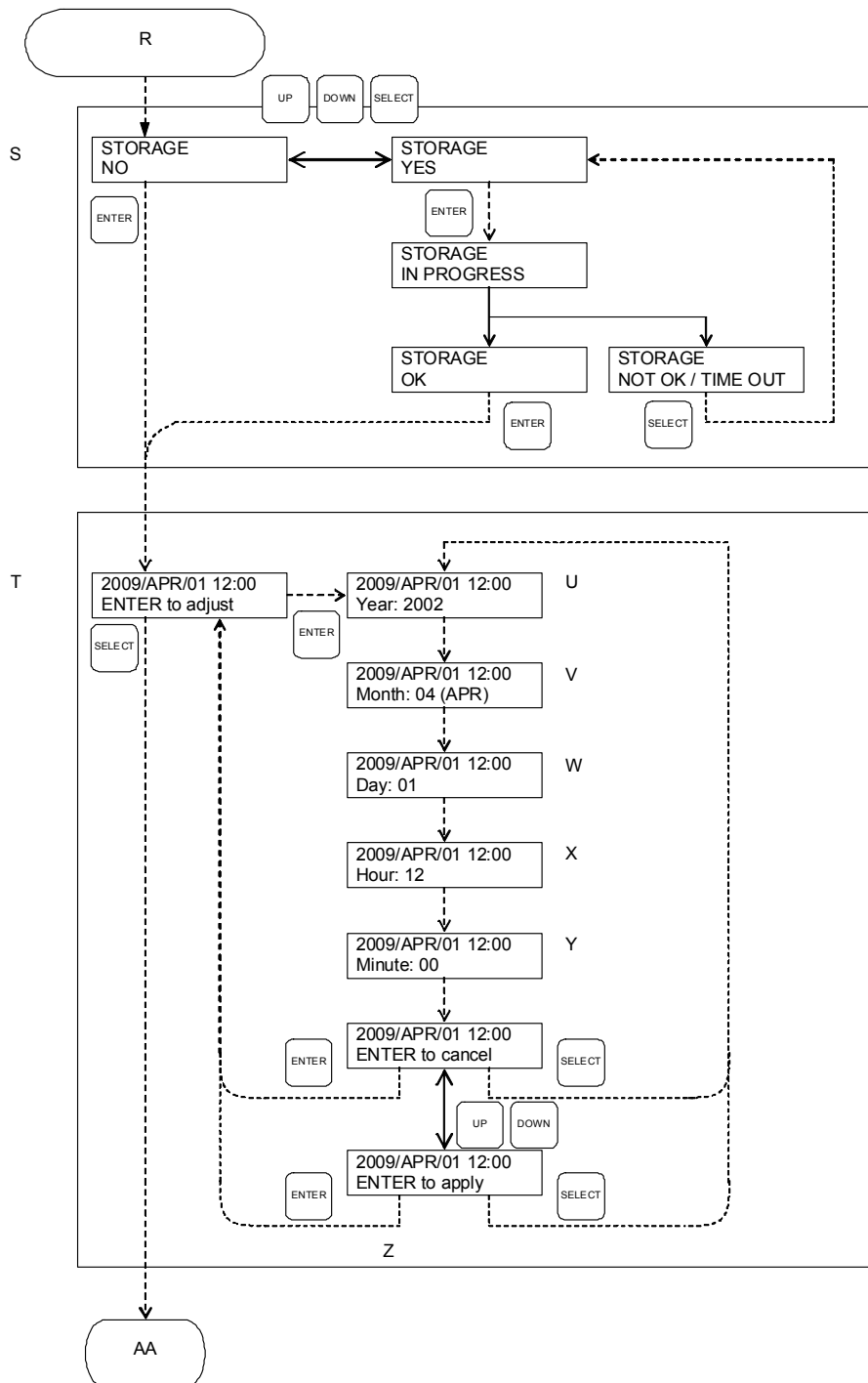

Figure 28 - Parameter setting method (continued)

- |                                    |   |
|------------------------------------|---|
| R. From Serial port COM2 setting   | W. Press "UP/DOWN" to change Day          |
| S. Storing display                 | X. Press "UP/DOWN" to change Hour         |
| T. Date/Time setting display       | Y. Press "UP/DOWN" to change Minute       |
| U. Press "UP/DOWN" to change Year  | Z. Press "ENTER" to set Date/Time setting |
| V. Press "UP/DOWN" to change Month | AA. To Operation mode display             |



3.12 Manual operation mode

The operation of the TMS heater, TMS water valve and the emergency vent valve can be inspected in manual operation mode. However, the manual operation cannot be performed during the remote operation.

1. Press the "DOWN" and "SELECT" switches simultaneously to enter Manual Mode, then "Manual Operation TMS Heater OFF" is displayed.
2. Press "UP" switch to display "TMS Heater ON", and the TMS Heater output turns "ON". Press "DOWN" switch to display "TMS Heater OFF", and the TMS Heater output turns "OFF".
3. Press "SELECT" switch to display "TMS Water Valve Close", and the TMS water valve can be operated manually with "UP" and "DOWN" switches.
4. Press "SELECT" switch to display "Leak Valve Close" and the emergency vent valve can be operated manually with "UP" and "DOWN" switches.
5. Press "SELECT" switch in the Emergency vent valve operation to return to the Operation Mode.

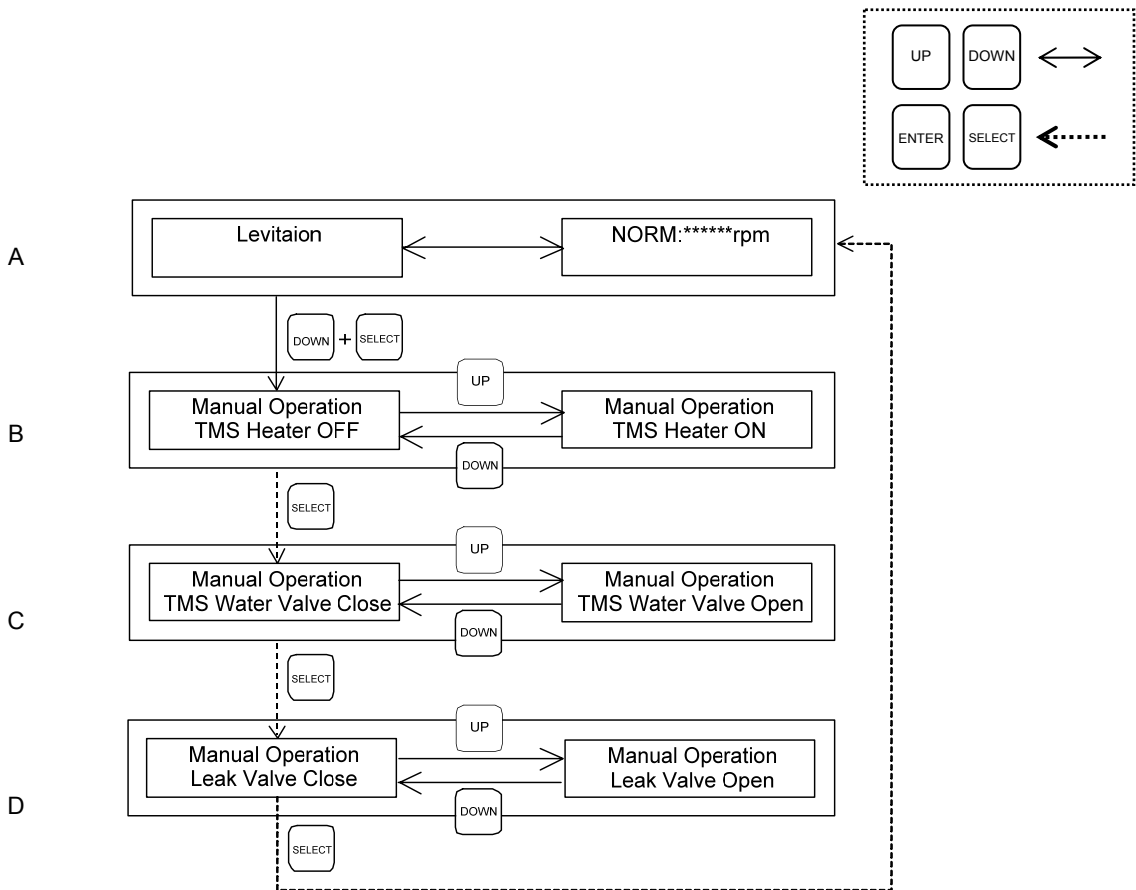

Figure 29 - Manual operation method

- |                   |                         |
|-------------------|-------------------------|
| A. Operation mode | C. TMS water valve      |
| B. TMS heater     | D. Emergency vent valve |



---

*SCU-1600 Control Unit for Turbomolecular Pump*

3

INSTALLATION

This page intentionally blank.

## 4 OPERATION

### 4.1 Before starting the STP pump

#### CAUTION

NEVER connect or disconnect any cables while the power is ON. NEVER turn the primary power OFF (turn the MAIN POWER "OFF") while the STP pump is in rotation. DO NOT release the inlet port flange or outlet port flange into the atmosphere while the STP pump is rotating.

#### 4.1.1 Confirmation before starting

After completing the installation of the STP pump and the SCU-1600, carry out the following checks before starting:

1. Ensure the STP pump and the SCU-1600 are installed correctly (refer to Section 3).
2. Ensure the correct supply voltage is applied.
3. Ensure all cables are securely connected and locked.
4. Ensure the length of the STP connection cable. If it is changed, perform the tuning according to Section 3.9.1, "Tuning".

#### 4.1.2 Confirmation of vacuum system

1. Starting backing-pump

Start the backing-pump before or simultaneously with the start of the STP pump. Open the vacuum valve located at the outlet port flange side after starting the backing-pump.

*Note: DO NOT open the vacuum valve without operating the backing-pump. Depending upon the type of the backing-pump, doing so may cause a reverse flow of oil, which could contaminate the inside of the STP pump.*

2. Stop backing-pump

#### CAUTION

DO NOT stop the backing-pump without closing the vacuum valve. Depending upon the type of the backing-pump, doing so could cause a reverse flow of atmospheric air into the STP pump, which may result in a malfunction.

Close the vacuum valve located at the outlet port flange side just before or after stopping the STP pump. After closing the valve, stop the backing-pump.

*Note: DO NOT stop the backing-pump without closing the vacuum valve. Depending upon the type of the backing-pump, doing so could cause a reverse flow of oil, which could contaminate the inside of the pump.*

**SCU-1600 Control Unit for Turbomolecular Pump**

**4.2 Powering ON**

**4.2.1 Self test**

Refer to Figure 30.

1. Switch the MAIN POWER to "ON", located on the SCU-1600 rear panel, refer to Figure 11. (To prevent incorrect operation, a metal fitting is attached to the breaker. Loosen the screw, lift the metal fitting and secure it.) The SCU-1600 performs a self test and "Autotest" is displayed on the LCD.
2. If no error is found, the LCD displays "Autotest complete" and the magnetic bearing is turned "ON". When the rotor levitates normally, the LCD displays "Levitation" and the STP pump can be operated.

**4.2.2 "CAUTION" message in the self test state**

When the configuration (the STP pump serial number or the SCU-1600) is changed, a "CAUTION" message is displayed on the LCD during the self test. Refer to Table 37 when "CAUTION" is other than those in Table 7.

<b>CAUTION message</b>	<b>Causes</b>
Coupling is Changed	Connecting the same model but the different serial number of the STP pump to the SCU-1600 after the tuning is performed.
Pump Type is Changed	Connecting the different model of the STP pump to the SCU-1600 after the tuning is performed.
Pump Type is Mismatch	Using the different series of the STP pump with the SCU-1600 control unit. Use the specific control unit.

Table 7 - Causes of "CAUTION" at the self test state

Perform as follows when "CAUTION : Coupling is Changed" or "CAUTION : Pump Type is Changed" is displayed.

1. When pressing the "RESET" switch, the LCD displays the model name of the STP pump currently connected and the confirmation message to copy the data of the STP pump onto the SCU-1600.  
 Example: "STP-A2503/A3003", "DATA COPY? No"
2. When the exact model name is displayed, press the "UP" or "DOWN" switch. "DATA COPY? Yes" is displayed on the LCD. In the case of the LCD displays an unexpected model name of the STP pump, turn the breaker "OFF." After checking the configuration, re-start the STP pump.
3. Press the "ENTER" switch in the state of "DATA COPY? Yes" on the LCD. "Press RESET 3 sec to Update Data" is displayed on the LCD.
4. Press the "RESET" switch 3 sec. or more. "Updating data from Pump to PCB" is displayed for a few second, and then "Tuning" is displayed, the tuning is performed automatically.

## SCU-1600 Control Unit for Turbomolecular Pump

5. After completing the tuning, "Levitation" is displayed on the LCD and the rotating operation of the STP pump can be started.

See Section 7, "MAINTENANCE", when an abnormality/error occurs other than above during the tuning.

### 4.3 How to start/stop the STP pump

There are two methods of operating the STP pump; MANUAL and REMOTE. Select one which suits your vacuum equipment.

### 4.4 Manual start/stop the STP pump

To manually start/stop the STP pump, slide the "MANUAL/REMOTE" changeover switch on the SCU-1600 front panel from the "ON" position, refer to Figure 10. The "REMOTE" LED will extinguish.

#### 4.4.1 Starting the STP pump

1. Press the "START" switch on the front panel to start, refer to Figure 10 and accelerate the STP pump. The "ACCEL." LED illuminates. The LCD displays the current rotational speed in "ACCEL: \*\*\*00rpm" in 500 rpm intervals. (ACCELERATION state)
2. When the STP pump attains the rated speed of rotation, the "ACCEL." LED extinguishes, and the "NORMAL" LED illuminates. The LCD displays "NORM: \*\*\*00rpm". (NORMAL OPERATION state)

#### 4.4.2 Stopping the STP pump

1. Press the "STOP" switch on the front panel to stop the STP pump.
2. The "NORMAL" LED or "ACCEL." LED extinguishes, and the "BRAKE" LED illuminates. (BRAKE state)
3. When the rotational speed decreases to 500 rpm or less, the "BRAKE" LED extinguishes.

#### 4.4.3 Starting the STP pump after stopping

1. Press the "START" switch on the front panel to accelerate the STP pump.
2. The STP pump can be accelerated even while it is stopping.

*Note: Avoid frequent start/stop operations as this may cause the STP pump to overheat.*

SCU-1600 Control Unit for Turbomolecular Pump

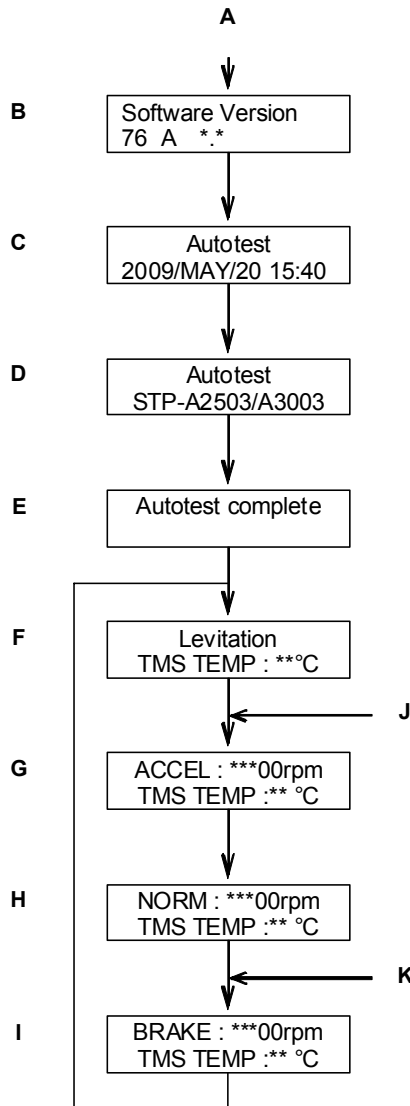

Figure 30 - Operational procedures

- |  |  |  |
|--|--|--|
| A. MAIN POWER "ON"   | E. Self test completed<br>(upper only)   | H. Normal Operation State<br>Upper: Normal operation state<br>Lower: TMS actual temp<br>(for only with TMS unit) |
| B. Version   | F. Levitation State<br>Upper: Levitation state<br>Lower: TMS actual temp<br>(for only with TMS unit)     | I. Break State<br>Upper: Brake state<br>Lower: TMS actual temp<br>(for only with TMS unit)                       |
| C. Self test<br>Upper: Autotest<br>Lower: Date                       | G. Acceleration State<br>Upper: Acceleration state<br>Lower: TMS actual temp<br>(for only with TMS unit) | J. Start operation of the STP pump   |
| D. Self test<br>Upper: Autotest<br>Lower: Model of<br>connected pump |  | K. Stop operation of the STP pump  |



## SCU-1600 Control Unit for Turbomolecular Pump

### 4.5 Remote operation

To select remote operation, slide the "MANUAL/REMOTE" changeover switch on the SCU-1600 front panel to "ON", refer to Figure 10. The "REMOTE" LED illuminates.

#### 4.5.1 Input signal pins

Use input signal pins according to Table 8, Table 9 and Figure 31. Remote input signals are set to the parallel port in the remote setting and function during REMOTE operation only, expect pins for inputting the ROTATION INHIBIT.

Two abbreviations are used in Table 8, Table 9 and Figure 31:

COM: Common Pin

IN: Input Pin



Pin	Description
	<p>Pins for inputting the START signal. The following two methods are available:</p> <ol style="list-style-type: none"> <li>1) Short the circuits between (1)-(21). Then, short the circuits between (3)-(21) for 0.3 seconds or more. However, when inputting this START signal simultaneously with switching "ON" the breaker on the rear panel, continue to short these pins for 10 seconds or more.</li> <li>2) Short the circuits between (1)-(3). In this case, (21) is not used.</li> </ol>
	<p>Pins for inputting the STOP signal.</p> <ol style="list-style-type: none"> <li>1) When 1) above is used to start the STP pump, open the circuits between (1)-(21) to stop the STP pump.</li> <li>2) When 2) above is used to start the STP pump, open the circuits between (1)-(3) to stop the STP pump.</li> </ol>
	<p>Pins for inputting the abnormality RESET signal.</p> <p>When a safety function operates, remove the cause of the abnormality/error after confirming the STP pump has stopped. When the cause of the abnormality/error is removed, short the circuits between (1)-(22) for 0.3 seconds or more to extinguish the "FAILURE" LED.</p>
	<p>Pins for inputting the rotation INHIBIT signal (valid in both MANUAL and REMOTE operations).</p> <p>When pins (1)-(5) are set to open, the STP pump does not rotate even by performing the start operation. (The pump does not rotate even by manually starting the pump) When these pins are set to open while the pump is in rotation, the pump will stop.</p> <p>When the INHIBIT signal is release, the pump restarts.</p> <p>When not using this function, set the rotation INHIBIT signal function to the "DISABLE" (see Section 3.11, "Parameter set mode").</p>
	<p>Pins for option signal input.</p> <p>Unused.</p>

Table 8 - REMOTE X7 input signal pins

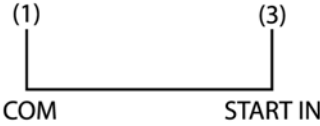
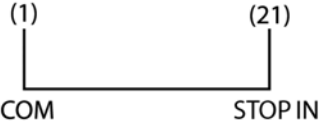

**SCU-1600 Control Unit for Turbomolecular Pump**

Pin	Description
 <p>(1)                      (23) COM                      OPT2 IN</p> <p>(18), (36)</p>	<p>Pins for inputting the second speed select signal (valid in both MANUAL and REMOTE operations). When pins (1)-(23) are set to close, rotational speed will be second speed in the normal state. When using this function, set the second speed option to the "ENABLE" (Parallel port operation) (see Section 3.11, "Parameter set mode").</p> <p>For the serial communication of the R485 (COM2). See Section 5, "Serial Communication Protocol" for details.</p>
<p>(2), (19), (20), (31), (34)</p>	<p>These pins are not used.</p> <div style="background-color: #f0f0f0; padding: 5px; text-align: center;"> <p><b>CAUTION</b> DO NOT connect anything to these pins. Doing so may damage the SCU-1600 or the vacuum equipment.</p> </div>

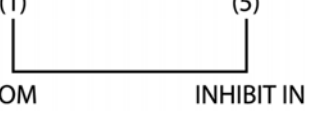
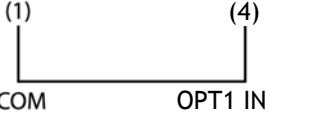
Table 9 - REMOTE X7 input signal pins (continued)

SCU-1600 Control Unit for Turbomolecular Pump

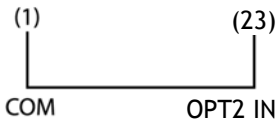
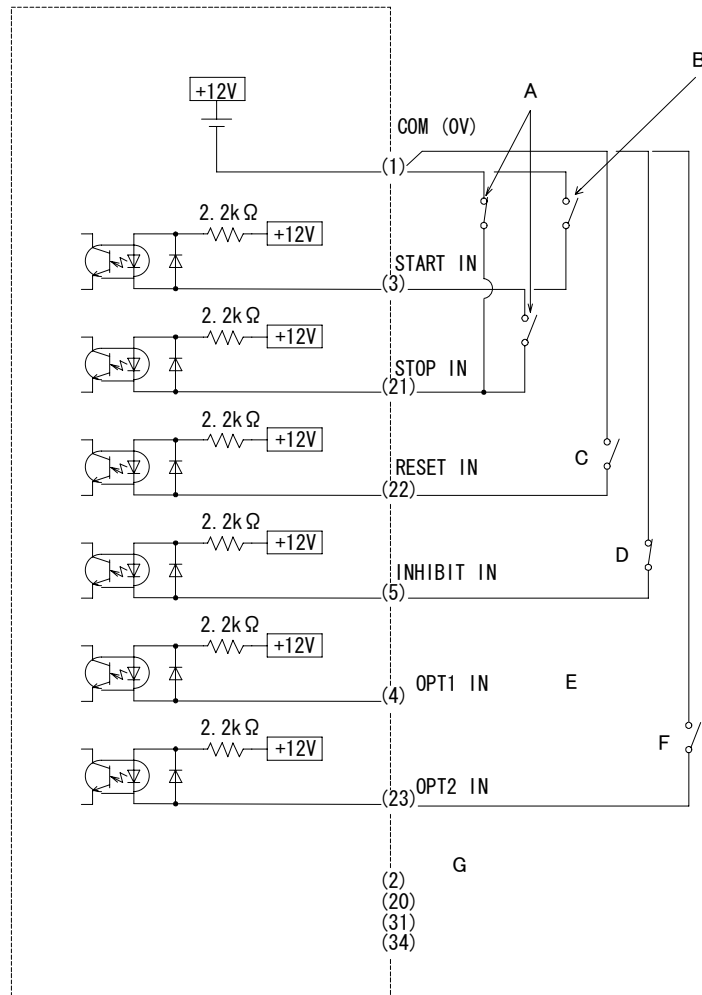

- A. In case of Start 1)
- B. In case of Start 2)
- C. RESET signal
- D. Rotation INHIBIT signal
- E. Unused pins
- F. Second speed select signal

Figure 31 - REMOTE X7 input signal pins

Note: 1 pin (0V) is insulated from the frame ground.

Note: The input current of remote input signal is approximately 5 mA. Make sure the minimum applicable load of the relay contact when the remote operation with the relay.

Note: It is recommended to use a remote cable with shield type, and connect both terminals to the ground.



## SCU-1600 Control Unit for Turbomolecular Pump

### 4.5.2 Output signal pins

Use output signal pins according to Table 9, Table 10 and Figure 32. Remote output signals function during MANUAL and REMOTE operations. Three abbreviations are used in Table 9, Table 10 and Figure 32.

N.O OUT: Normal Open Output Pin  
N.C OUT: Normal Close Output Pin  
COM: Common Pin

Pin	Description
<p style="text-align: center;">WARNING OUT</p>	<p>Pins for the WARNING signal output. When the WARNING message is displayed on the LCD, the pins between (24)-(6) are closed and the pins between (25)-(6) are opened.</p>
<p style="text-align: center;">REMOTE N.O OUT</p>	<p>Pins for outputting the STP pump REMOTE SELECTION state signal. When the MANUAL/REMOTE changeover switch on the front panel is set to ON (remote side), these pins are closed ("REMOTE" operation).</p>
<p style="text-align: center;">POWER N.O OUT</p>	<p>Pins for outputting the POWER ON state signal. These pins are closed when magnetic bearing functions and the rotor levitates. This output is opened at a power failure.</p>
<p style="text-align: center;">ACCELERATION N.O OUT</p>	<p>Pins for outputting the ACCELERATION state signal. These pins are closed when the STP pump is in acceleration.</p>
<p style="text-align: center;">NORMAL OUT</p>	<p>Pins for outputting the NORMAL OPERATION state signal. When the STP pump is in rated operation, the pins between (11)-(30) are closed, and the pins between (12)-(30) are opened.</p>
<p style="text-align: center;">BRAKE N.O OUT</p>	<p>Pins for outputting the BRAKE state signal. These pins are closed when the STP pump is in brake.</p>
<p style="text-align: center;">ALARM OUT</p>	<p>Pins for outputting the ALARM signal. When an abnormality/error is detected under the POWER ON state, the pins between (14)-(33) are closed, and the pins between (15)-(33) are opened.</p>
<p style="text-align: center;">ATTEMP OUT</p>	<p>Pins for the TMS unit rated state signal output. When the actual temperature of the TMS unit is within the setting temperature range <math>\pm 10^{\circ}\text{C}</math>, the pins between (16)-(17) are closed and the pins between (35)-(17) are opened.</p>

Table 10 - REMOTE X7 output signal pins

**SCU-1600 Control Unit for Turbomolecular Pump**

Pin	Description
	<p>Pins for optional signal output.</p> <p>The emergency vent valve (optional accessory) can be connected. These pins are closed while this valve functions. In state of the emergency vent valve function is "ENABLE", the pins between (7)-(26) are closed and the pins between (37)-(26) are opened.</p> <hr/> <p>In state of the second speed option is "ENABLE", and second rating speed is selected, the pins between (7)-(26) are closed and the pins between (37)-(26) are opened.</p>

Table 11 - REMOTE X7 output signal pins (continued)

SCU-1600 Control Unit for Turbomolecular Pump

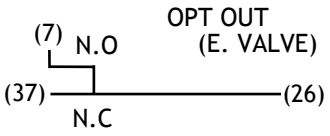
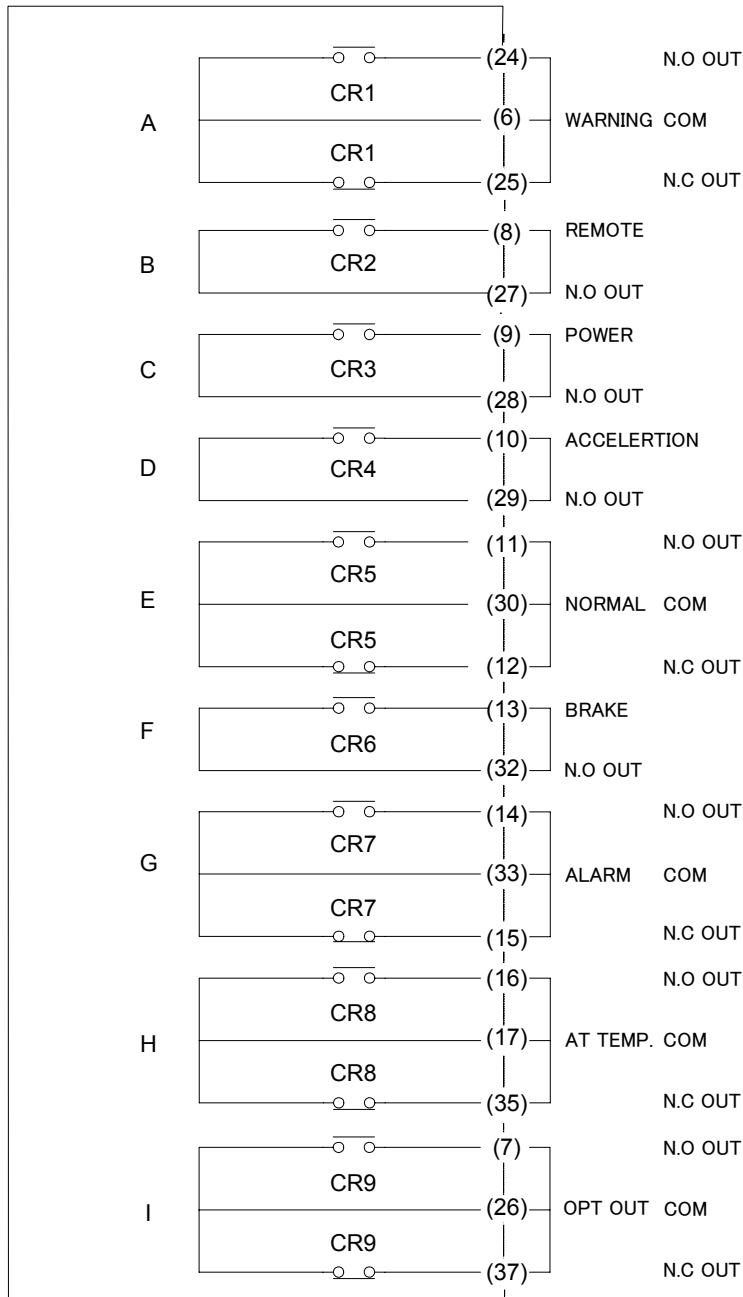

- |   |   |
|---|---|
| A. WARNING state<br>signal output pins          | F. BRAKE state<br>signal output pins  |
| B. REMOTE selection state<br>signal output pins | G. ALARM state<br>signal output pins  |
| C. POWER ON state<br>signal output pins         | H. TMS unit rated state<br>signal output pins                                       |
| D. ACCELERATION state<br>signal output pins     | I. Optional signal output pins<br>(Emergency vent valve open<br>signal output pins) |
| E. NORMAL OPERATION state<br>signal output pins |   |

Figure 32 - REMOTE X7 output signal pins

**SCU-1600 Control Unit for Turbomolecular Pump**

Table 12 shows the rated contacts for relays CR1 to CR9 in Figure 32.

	<b>Resistance Load (COS Ø=1)</b>
Rated Load	125 VAC, 0.5 A 24 VDC, 1 A
Rated Current	2 A
Maximum Contact Point Current	1 A
Maximum Open/Close Capacity	AC: 62.5 VA DC: 30 W
Minimum Applicable Load	5 VDC, 1 mA

Table 12 - Rated contacts for relays CR1 to CR9

**4.5.3 Remote setting**

The parallel port (REMOTE X7) and serial port COM1 (REMOTE X3A/X3B), serial port COM2 (REMOTE X7) and STP-Link (X8) are fitted as standard. For the setting method of remote operation hardware, refer to Section 3.11.

This section details the operating method using the parallel port (REMOTE X7), refer to Figure 21, "X7 REMOTE connector" for details of pin location. For the operating method using the serial port, refer to Section 5 and Section 6.

**4.5.4 Starting/Stopping the STP pump**

There are two methods for the starting/stopping operation with the parallel port (REMOTE X7). Use one of them.

<b>Method</b>	<b>Starting the pump</b>	<b>Stopping the pump</b>
1	1) Short the circuit between (1)-(21). 2) Short the circuit between (3)-(21) for 0.3 seconds or more. However, when inputting this signal simultaneously with switching "ON" the breaker on the rear panel, short the circuit between (3)-(21) for 10 seconds or more.	Open the circuit between (1)-(21).
2	Short the circuit between (1)-(3). In this case, (21) is not used.	Open the circuit between (1)-(3).

Table 13 - Starting/Stopping the STP pump during remote operation (REMOTE X7)

4.5.5 Rotation INHIBIT signal

When using rotation INHIBIT signal, set the rotation INHIBIT function to the "ENALBE" according to Section 3.11, "Parameter set mode". Relations between rotation INHIBIT signal input and pump operation state are shown in Table 14.

Signal input	Pump operation
<p>After short-circuit of rotation INHIBIT input signal (A), the START operation is performed (B).</p> <p><b>INHIBIT IN</b></p> <p>Open</p> <p>Close</p> <p>START operation</p>	<p>&lt;MANUAL/REMOTE operation mode&gt;</p> <ul style="list-style-type: none"> <li>The pump accelerates when the START operation is performed (B).</li> </ul>
<p>After the START operation (A), the rotation INHIBIT input signal is short-circuited (B).</p> <p><b>INHIBIT IN</b></p> <p>Open</p> <p>Close</p> <p>START operation</p>	<p>&lt; MANUAL operation mode &gt;</p> <ul style="list-style-type: none"> <li>The pump does not accelerate.</li> </ul> <p>&lt; REMOTE operation mode &gt;</p> <ul style="list-style-type: none"> <li>The pump does not accelerate when the START operation is performed (A).</li> <li>The pump accelerates when the rotation INHIBIT input signal is short-circuited (B).</li> </ul>
<p>The rotation INHIBIT input signal is opened (A) during acceleration or normal operation.</p> <p><b>INHIBIT IN</b></p> <p>Open</p> <p>Close</p> <p>START operation</p>	<p>&lt; MANUAL/REMOTE operation mode &gt;</p> <ul style="list-style-type: none"> <li>The pump decelerates and stops when the rotation INHIBIT input signal is opened (A).</li> <li>After the operation (A), the pump continues deceleration and stops even by short-circuiting the rotation INHIBIT input signal (B). However, when the START signal is input, the pump will accelerate.</li> </ul>

Table 14 - Rotation INHIBIT signal input





### SCU-1600 Control Unit for Turbomolecular Pump

#### 4.5.6 Second speed option

When the second speed option is enabled, second rating speed can be set independently of the normal rating speed setting. The selection of the second rating speed and normal rating speed are operated from I/O remote input or serial communication port. (see Section 3.11, "Parameter set mode", Section 5.4, "Command specifications")

The second speed setting is changed from front panel or serial communication port. (see Section 3.11, "Parameter set mode", Section 5.4, "Command specifications")

Method	Second speed selection port	LCD display
1	Function disable	DISABLE
2	I/O remote	ENABLE - Parallel
3	Serial communication port (COM, COM2)	ENABLE - Serial

SCU-1600 Control Unit for Turbomolecular Pump

Table 15 shows pump status in the state of speed selection.

<b>Pump status</b>	
<p>Difference between Normal Speed and Standby Speed Setting is more than approximately 10%</p>	<p>When the rotational speed becomes low, the STP pump enters BRAKE mode, and then decelerates. When the rotational speed becomes high, the STP pump enters ACCEL mode, and then accelerates. The STP pump will enter the normal mode when the rotational speed attains within +10% of speed setting.</p>
<p>Difference between Normal Speed and Standby Speed Setting is approximately 10% or less</p>	<p>The rotational speed changes in the normal mode.</p>

Table 15 - Second speed function

**SCU-1600 Control Unit for Turbomolecular Pump**

**4.5.7 Starting the STP pump after stopping**

Perform the start operation to accelerate the STP pump. Refer to Section 4.5.4. The STP pump can be accelerated even while it is stopping.

**4.5.8 Starting the STP pump after a safety function operates**

A safety function operates when an abnormality/error occurs in the STP pump or peripheral equipment. To restart the STP pump, remove the cause of the abnormality/error after the "BRAKE" LED extinguishes and perform the operation shown in Table 16. The "FAILURE" LED extinguishes and the safety function is released (RESET operation). Restart the STP pump. For the safety functions and troubleshooting, refer to Section 7.

Method	Reset Operation
1	Short the circuit between (1)-(22) for 0.3 seconds or more.

Table 16 - Reset operation during remote operation (REMOTE X7)

**4.6 Powering OFF**

Turn the MAIN POWER "OFF" on the SCU-1600 rear panel when all three LEDs "ACCEL.", "NORMAL" and "BRAKE" extinguish. The magnetic bearing stops, the rotor stops, and the "POWER" LED extinguishes. (POWER OFF state)

## SCU-1600 Control Unit for Turbomolecular Pump

### 4.7 Operating the TMS unit (for use with the TMS unit)

#### 4.7.1 Before starting

Check the following items before starting:

1. Check that the TMS connection cable is securely connected to the SCU-1600.
2. Check that the TMS heater, the TMS valve, the cooling water pipe and the TMS sensor cable are securely connected.

*Note: The TMS sensor cable is not required depend on the type of the STP pump.*

#### 4.7.2 Starting/Stopping

Power on the STP pump to automatically start the TMS unit.

Power off the STP pump to automatically stop the TMS unit.

While the TMS unit is in operation, the "TEMP CTRL" LED illuminates on the SCU-1600.

When STP pump is in the power ON state, the TMS unit operates regardless of the status of the SCU-1600. When the STP pump is the cause of the malfunction, the TMS unit is stopped.

#### 4.7.3 Setting the TMS unit function

When the "TEMP CTRL" LED does not illuminate on the SCU-1600, after switching MAIN POWER "ON", the TMS function may be set to "DISABLE". Confirm and reset the TMS function according to Section 3.11.

#### 4.7.4 Temperature control

When the temperature of the STP pump base is lower than the setting value, the TMS heater is turned "ON", and the TMS valve is turned "OFF" to heat the STP pump. When the temperature of the STP pump base is higher than the setting value, the TMS heater is turned "OFF", and the TMS valve is turned "ON" to cool the STP pump. The LCD displays the actual temperature of the STP pump base as "TMS TEMP: \*\* °C".

## 5 SERIAL COMMUNICATION PROTOCOL

### 5.1 Introduction

The SCU-1600 is provided with compliant serial interface. Prepare the user application software according to this instruction manual. Operation instructions and information, such as the running state and setting values of the STP pump (information which appears on the LCD of the SCU-1600) can be obtained with the software.

The serial ports located on the SCU-1600 rear panel are called Serial Interface Module (SIM). Refer to Figure 33.

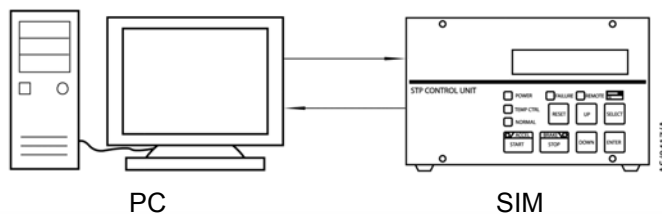

Figure 33 - Serial communication

### 5.2 Connection and setting up

#### 5.2.1 Signal connection

The STP control unit is equipped with 3 serial ports COM1, COM2 and STP-Link as a standard. Details of the serial ports COM1 and COM2 are as follows:

1. Serial Port COM1 (shared use by the RS232/485)

Connect the PC serial port to connectors X3A or X3B (a D-Sub9-pin, socket) on the rear panel. Connect TxD/RxD/GND in the RS232 and D+/D- in the RS485 in accordance with Table 17 (refer to Figure 34). DO NOT connect other pins which are reserved as optional use.

	<b>X3A (D-Sub9 pin, socket)</b>	<b>X3B (D-Sub9 pin, socket)</b>
RS232	2 (TxD)	-
	3 (RxD)	-
	5 (GND)	-
RS485	7 (D-)	7 (D-)
	8 (D+)	8 (D+)
Reserved	1, 4, 6, 9	1, 2, 3, 4, 5, 6, 9

Table 17 - X3A/X3B pin position

**SCU-1600 Control Unit for Turbomolecular Pump**

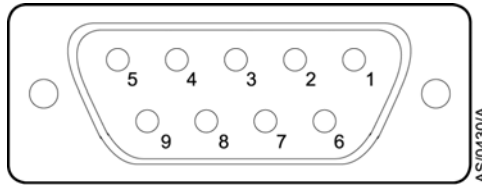

Figure 34 - Connector X3A/X3B (D-sub 9)

*Note: The connectors X3A and X3B are fitted using M2.6 screws.*

*Note: It is recommended to use a communication cable with shield type, and connect both terminals to the ground.*

RS232 and RS485 cannot be used at the same time. The factory setting is RS232. When connecting RS485, the change of communication parameter setting is required, refer to Section 3.11.

When connecting RS232, the length of the communication cable should be 15 m or less. When connecting RS485, refer to Section 5.2.2.

2. Serial Port COM2 (exclusively used in the RS485)

Connect D+/D- to connector X7 on the rear panel (D-Sub 37pin, socket) according to Table 18. Other pins are reserved for Input/Output remote function, accordingly, there is no connection to these pins.

Refer to Section 5.2.2.

	<b>X7 (D-Sub 37 pin, socket)</b>
RS485	36 (D+)
	18 (D-)

Table 18 - X7 pin position

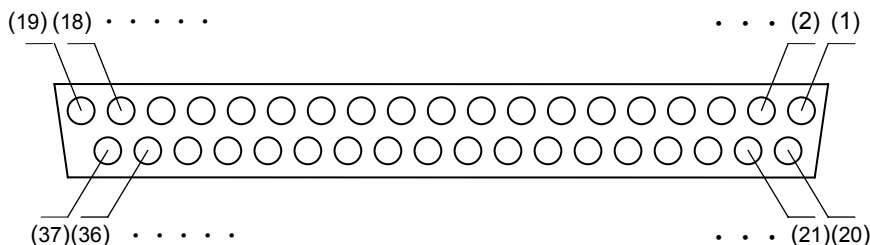

Figure 35 - Connector X7 (D-sub 37)

*Note: The connector X7 is fitted using M2.6 screws.*



---

**SCU-1600 Control Unit for Turbomolecular Pump**

3. Serial Port STP-Link (exclusively used in the RS232)

Connect signal transmitted from the PC to connector X8 on the front panel. Connect the optional STP-Link communication cable to the PC.

5.2.2 Connecting the RS485

Make sure the followings when using the serial port COM1 with RS485 or COM2.

A connection condition is 1 on 1 (single point connection) or 1 on N (multi-point connection).  
 A maximum number of 32 SIMs are connectable in the multi-point connection.

Use twisted-pair wire in communication cable. The extended communication cables should be 1.2 km or less.

Connect the terminator to the communication devices at both ends of the transmission line. The terminator (120 Ω, 0.25 W) is required for connection.  
 (the SCU-1600 dose not have terminator setting function)

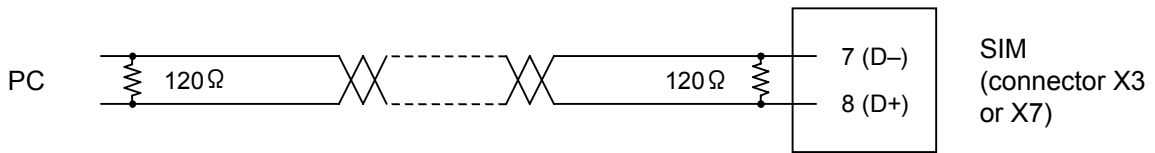

a) RS485 single point connection

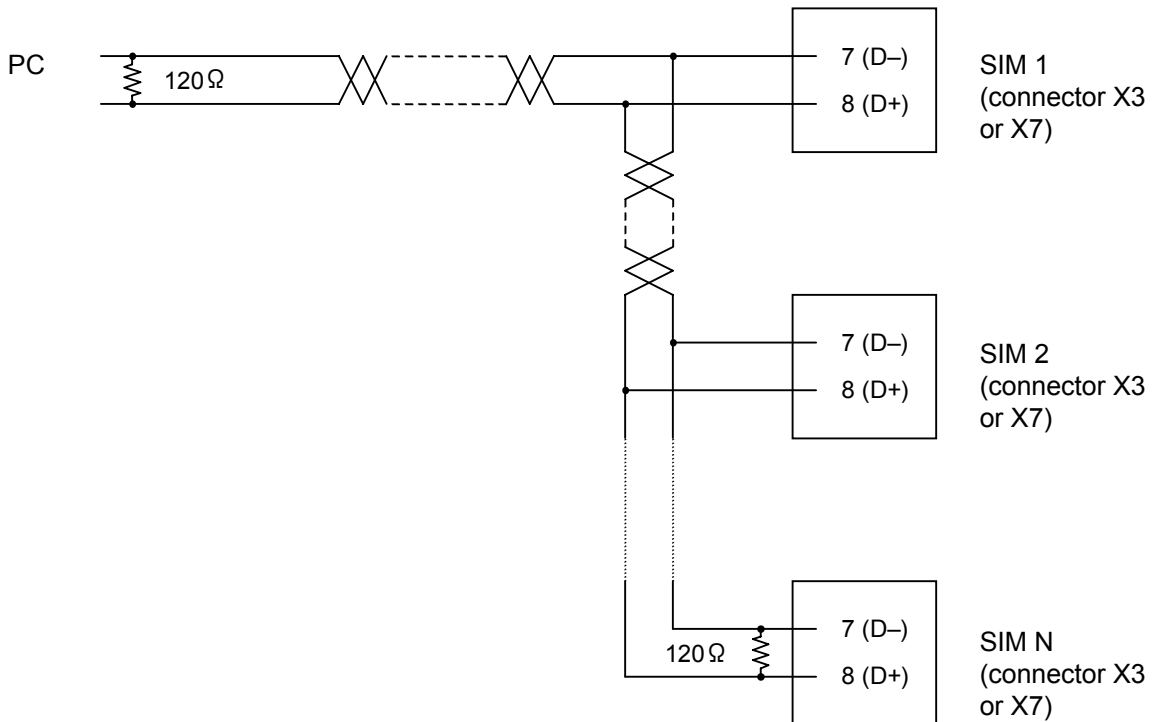

b) RS485 multi-point connection

Figure 36 - RS485 connections

*Note: It is recommended to use a communication cable (twisted-pair wire) with shield type, and connect both terminals to the ground.*



**SCU-1600 Control Unit for Turbomolecular Pump**

**5.2.3 Communication parameter setting**

The factory setting of the communication parameter is shown in Table 19. When changing the communication parameter, refer to Section 3.11, "Parameter set mode".

To use the operational commands of the SCU-1600 (START, STOP, RESET), set the MANUAL/REMOTE changeover switch on the SCU-1600 to "ON", and set a port to use the Remote mode, refer to Figure 10.

When the MANUAL/REMOTE changeover switch is "OFF" or a port which is not set as Remote mode, commands other than the operation commands can be used.

Communication parameter	SCU-1600	PC setting example
Remote mode	I/O Remote	I/O Remote, COM1, COM2, STP-Link
Baud rate	9,600 bps	110 to 19,200 bps
Bit length	8 bit	7, 8 bit
Stop bit	1 bit	1, 2 bit
Parity	None	None, Even, Odd
Driver type	RS232	RS232, RS485 single, RS485 multipoint
RS485ID <sup>*1</sup>	1	1 to 127

<sup>\*1</sup> This value is used with "RS485 Multipoint".

Table 19 - Communication parameters

**5.3 Protocol specifications**

**5.3.1 General description**

The STP serial communication protocol enables the SIM to receive the communication command, (Figure 37, item 1) transmitted from the PC and send a response, (Figure 37, item 2) following the communication command. Each communication command from the PC transmits a text message (ASCII text) assigned to each function. Communication commands include control commands (STP pump operation commands, and so forth) and query commands (read-out of STP pump operation mode, and so forth).

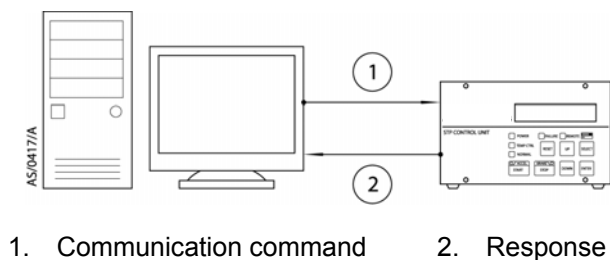

Figure 37 - PC to SIM communication

**SCU-1600 Control Unit for Turbomolecular Pump**

Table 20 shows ASCII characters being used in the transmission control, error control and handshake in the application layer. Note that the transmission frame form differs depending upon the RS232/RS485 single point connection and RS485 multi-point connection. (refer to Section 5.3.8)

	<b>ASCII character</b>	<b>HEX code</b>	<b>Function</b>
Transmission layer	Stx	02	Transmission block start character
	Etx	03	Transmission frame end character
	Etb	17	Transmission block end character
	Ack	06	Acknowledgment response
	Nak	15	Non-acknowledgment response
	@	40	Network frame ID character
Application layer	#	23	Acknowledgment response
	!	21	Non-acknowledgment response

Table 20 - Transmission control characters

**5.3.2 Standard transmission frame (in the RS232/RS485 single point connection)**

The transmission frame used in the RS232/RS485 single point connection has a single block or multiple transmission blocks. The transmission block consists of a start control character, data block No. (3 digits), a message (up to 255 characters), an end control character and a checksum (Longitudinal Redundancy Check (LRC)). The following table shows the transmission frame where the message transmission character string is  $C_n$ .

Transmission frame when a message is below 255 characters ( $n \leq 255$ ):

	1	2	3	4	5		5+n	5+n+1	5+n+2
ASCII	Stx	0	0	1	$C_1$		$C_n$	Etx	LRC

"Stx" and "Etx" are used as a start and an end character of the transmission frame, respectively.

**SCU-1600 Control Unit for Turbomolecular Pump**

Transmission frame when a message exceeds 255 characters ( $n = 255$ ,  $m \leq 255$ ,  $k =$  the number of transmission blocks):

First		1	2	3	4	5		5+n	5+n+1	5+n+2
Block	ASCII	Stx	0	0	1	C <sub>1</sub>		C <sub>1</sub> <sub>n</sub>	Etb	LRC
Second		1	2	3	4	5		5+n	5+n+1	5+n+2
Block	ASCII	Stx	0	0	2	C <sub>2</sub>		C <sub>2</sub> <sub>n</sub>	Etb	LRC
Final		1	2	3	4	5		5+m	5+m+1	5+m+2
Block	ASCII	Stx	k			C <sub>k</sub>		C <sub>k</sub> <sub>m</sub>	Et <sub>x</sub>	LRC

"Stx" is used as a start character of each transmission block; "Et<sub>b</sub>" is used as an end character of the transmission block with a message of 255 characters; "Et<sub>x</sub>" is used as an end character of the final transmission block (the end character of the transmission frame).

**5.3.3 Control command (in the RS232/RS485 single point connection)**

A control command is used when transmitting a pump operation command and a setting change command to the SIM. The first character of the control command in the RS232/RS485 single point connection is "Bsp" (a space character, HEX code "20") and succeeding characters are ASCII characters corresponding to the respective function code and parameter.

Bsp	CHR	C <sub>1</sub>	C <sub>2</sub>			C <sub>n</sub>
-----	-----	----------------	----------------	--	--	----------------

CHR: Function code character, C<sub>1</sub> to C<sub>n</sub>: Parameter.

Parameter (from C<sub>1</sub> to C<sub>n</sub>) serves as 16 bits signed hexadecimal value coded ASCII text. When a message (a space character, a function code, and parameter) exceeds 255 characters, input "Bsp" and CHR to the top transmission block only (the first transmission block of the transmission frame). It is not necessary to input them to the second and succeeding transmission blocks.

The SIM returns the acknowledgment response character "#" when the control command is processed normally. If not, the SIM returns the non-acknowledgment response character "!" and 3 characters of the non-acknowledgment code are added to "!".

Transmission frame when data is transmitted to one block (a message is less than 256 characters):

Designate the control command on the PC.

<- Less than 256 chr. ->

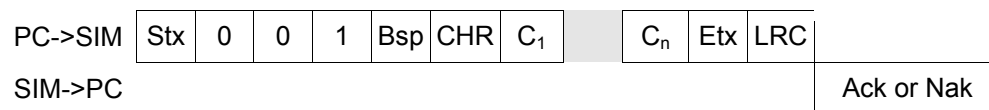

Always assign less than 254 characters ( $n < 254$ ) to the parameter so that the message is less than 256 characters.

**SCU-1600 Control Unit for Turbomolecular Pump**

Then the preceding SIM->PC character is "Ack", the instructed control command is executed and the SIM returns the following response.

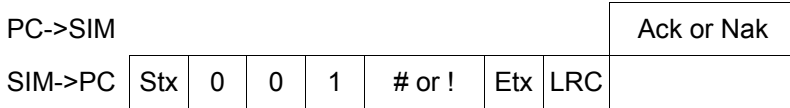

The PC transmits "Ack" or "Nak"; then transmits the next command if necessary.

Transmission frame when data is transmitted to two blocks (message is more than 256 characters and less than 512 characters):

Designate the control command (the 1st block) on the PC

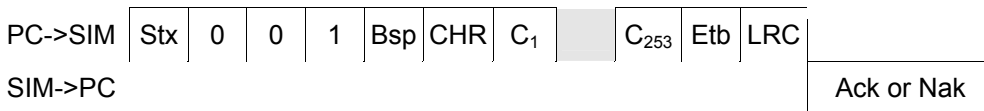

Next, the preceding SIM->PC character is "Ack", the PC continues instructing the control command (the 2nd block).

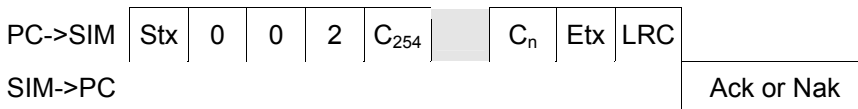

Always assign less than 510 characters ( $n < 510$ ) to the parameter so that the message is less than 512 characters.

Then the preceding SIM->PC character is "Ack", the instructed control command is executed and the SIM returns the following response.

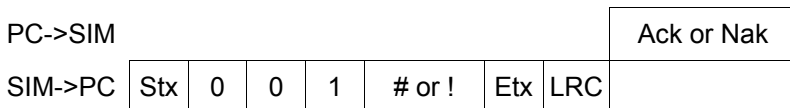

The PC transmits "Ack" or "Nak"; then transmits the next command if necessary.

**5.3.4 Query command (in the RS232/RS485 single point connection)**

A query command is used to read the pump operation state and setting values. The first character of the query command in the RS232/RS485 single point connection is "?"(HEX code "3F"), and succeeding characters are ASCII characters corresponding to the respective function code and parameter.

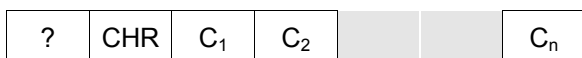

CHR: Function code character, C<sub>1</sub> to C<sub>n</sub>: Parameter

**SCU-1600 Control Unit for Turbomolecular Pump**

Parameter (from C<sub>1</sub> to C<sub>n</sub>) serves as 16 bits signed hexadecimal value coded ASCII text. When a message (a space character, a function code, and parameter) exceeds 255 characters, input "?" and CHR to the top transmission block only (the first transmission block of the transmission frame). It is not necessary to input them to the 2nd and succeeding transmission blocks.

The SIM returns the acknowledgment response character "#" when the query command is processed normally. If not, the SIM returns the non-acknowledgment response character "!" and 3 characters of the non-acknowledgment code are added to "!".

Transmission frame when data is transmitted at one block and returned at two blocks:

Designate a query command on the PC

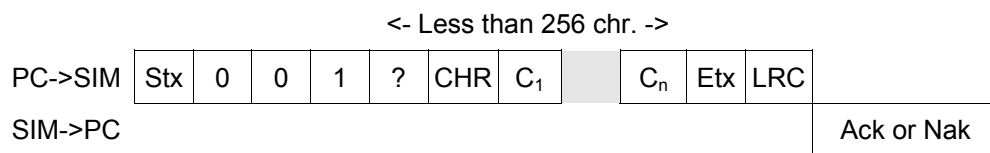

Always assign less than 254 characters (n < 254) to the parameter so that the message is less than 256 characters.

Next, the preceding SIM->PC character is "Ack", the instructed query command is executed and the SIM returns the following response (1st block).

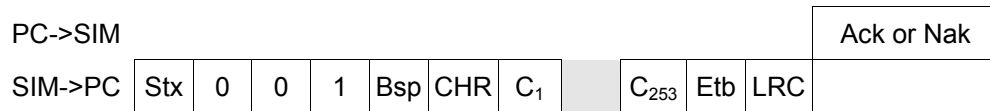

Then "Ack" is sent by the SIM->PC character in reaction to the response (1st block) from the SIM, the SIM returns the following response (2nd block).

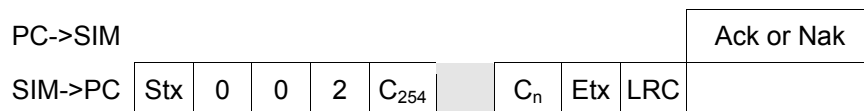

The PC transmits "Ack" or "Nak"; then transmits the next command if necessary.

**5.3.5 Transmission data format**

Data value is always 16 bits signed hexadecimal value coded ASCII text.

Example: 12090 on a decimal basis equals to 2F3A on a hexadecimal basis.

**5.3.6 Frame control (checksum)**

The transmission frame is controlled by the odd number parity check. First initialize LRC as FF<sub>hex</sub>. Next calculate LRC by EXCLUSIVE-OR (XOR) of all the frame bytes containing "Stx", "Etb", "Etx" and LRC and transmit the result as LRC.

Examples:

Character string for calculation before calculating LRC.

ASCII	Stx	0	0	1	#	Etx	LRC
HEX	02	30	30	31	23	03	FF

Calculation of LRC:

$$02_{hex} \text{ XOR } 30_{hex} \text{ XOR } 30_{hex} \text{ XOR } 31_{hex} \text{ XOR } 23_{hex} \text{ XOR } 03_{hex} \text{ XOR } FF_{hex} = EC_{hex}$$

Character string for transmission after calculating LRC.

ASCII	Stx	0	0	1	#	Etx	LRC
HEX	02	30	30	31	23	03	EC

**5.3.7 Error control**

- Transmit the transmission frame repeatedly from the PC when the SIM transmits "Nak" (parity check error). When the SIM receives "Nak" from the PC, the transmission frame is transmitted again. This operation is repeated up to 5 times.
- The SIM transmits "Ack" or "Nak" to the PC after the completion of communication command reception. When the PC cannot receive "Ack" or "NaK" after 2 second, retransmit the transmission frame from the PC.

When these communication status occur repeatedly, display to an error message or start the error routine on the PC.

**5.3.8 Transmission frame in the RS485 multi-point connection**

To identify a network frame and ensure the compatibility with a standard transmission frame, add a network frame ID character "@" and a title of 3 characters of network frame number to the transmission frame in the RS485 multi-point connection.

The network frame number is specified by any 16 bits signed hexadecimal value coded ASCII text of 1 to 127, to identify the SIM.

**SCU-1600 Control Unit for Turbomolecular Pump**

Examples: Network frame ID character and number in the multi-point connection

ASCII	@	0	1	Network frame No "1"
HEX	40	30	31	
ASCII	@	6	4	Network frame No "100"
HEX	40	36	34	
ASCII	@	7	F	Network frame No "127"
HEX	40	37	46	

The transmission frame has a single block or multiple transmission blocks. Each transmission block consists of a network frame ID character, a network frame number, a start control character, data block number (3 digits), a message (up to 255 characters), an end control character and a checksum (LRC). The following shows the transmission frame when the message transmission character string is  $C_n$ .

Transmission frame when a message is below 255 characters ( $n \leq 255$ ):

	1	2	3	4	5	6	7	8		8+n	8+n+1	8+n+2
ASCII	@	F <sub>1</sub>	F <sub>2</sub>	Stx	0	0	1	C <sub>1</sub>		C <sub>n</sub>	Et <sub>x</sub>	LRC

"@" is used as a network frame ID character.

"Stx" and "Et<sub>x</sub>" are used as a start and an end character of the transmission frame, respectively.

Transmission frame when a message exceeds 255 characters ( $n = 255$ ,  $m \leq 255$ ,  $k =$  the number of transmission blocks)

First Block		1	2	3	4	5	6	7	8		8+n	8+n+1	8+n+2
	ASCII	@	F <sub>1</sub>	F <sub>2</sub>	Stx	0	0	1	C <sub>1</sub>		C <sub>1</sub> <sub>n</sub>	Et <sub>b</sub>	LRC
Second Block		1	2	3	4	5	6	7	8		8+n	8+n+1	8+n+2
	ASCII	@	F <sub>1</sub>	F <sub>2</sub>	Stx	0	0	2	C <sub>2</sub>		C <sub>2</sub> <sub>n</sub>	Et <sub>b</sub>	LRC
Final Block		1	2	3	4	5	6	7	8		8+m	8+m+1	8+m+2
	ASCII	@	F <sub>1</sub>	F <sub>2</sub>	Stx	k			C <sub>k</sub>		C <sub>k</sub> <sub>m</sub>	Et <sub>x</sub>	LRC

"@" is used as a network frame ID character.

"Stx" is a start character of each transmission block, and "Et<sub>b</sub>" is an end character of the transmission block of a message of 255 characters.

"Et<sub>x</sub>" is used as an end character of the final transmission block (end character of the transmission frame).

**SCU-1600 Control Unit for Turbomolecular Pump**

**5.3.9 Control command in the RS485 multi-point connection**

The control command to be used when a pump operation instruction or a setting change instruction is transmitted to the SIM and is arranged in the order specified below. The top is "Bsp" (space character, HEX code "20") and ASCII characters corresponding to the respective function code and parameter follow.

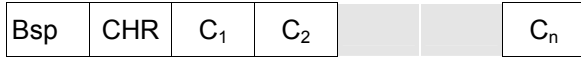

CHR: Function code character, C<sub>1</sub> to C<sub>n</sub>: Parameter

Parameter (from C<sub>1</sub> to C<sub>n</sub>) serves as 16 bits signed hexadecimal value coded ASCII text. When a message (a space character, a function code, and parameter) exceeds 255 characters, input "Bsp" and CHR to the top transmission block only (the first transmission block of the transmission frame). It is not necessary to input them to the second and succeeding transmission blocks.

The SIM returns the acknowledgment response character "#" when the control command is processed normally. If not, the SIM returns the non-acknowledgment response character "!" and 3 characters of the non-acknowledgment code are added to "!".

Transmission frame when data is transmitted to one block (a message is less than 256 characters):

Designate the control command on the PC.

<- Less than 256 chr.->

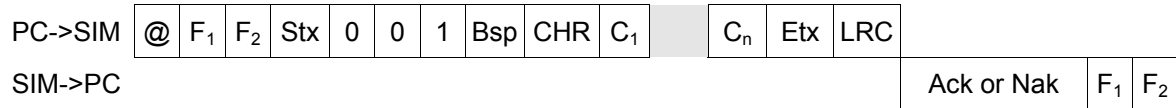

Always assign less than 254 characters (n < 254) to the parameter so that the message is less than 256 characters.

Next, the preceding PC->SIM character is "Ack", the instructed control command is executed and the SIM returns the following response.

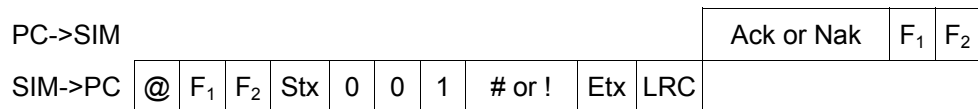

The PC transmits "Ack" or "Nak"; then transmits the next command if necessary.

Transmission frame when data is transmitted to two blocks (message is more than 256 characters and less than 512 characters):

Designate the control command (the 1st block) on the PC.

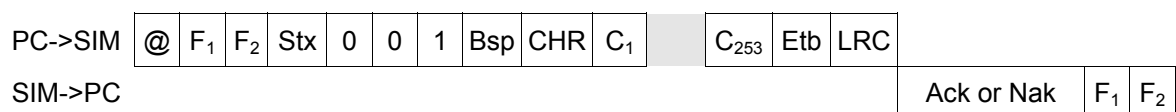



**SCU-1600 Control Unit for Turbomolecular Pump**

Next, the preceding SIM->PC character is "Ack", the PC continues instructing the control command (the 2nd block).

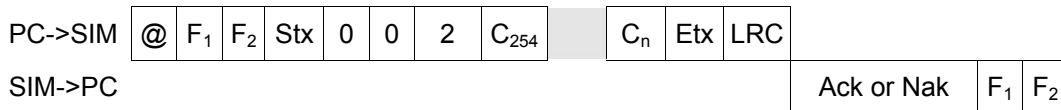

Always assign less than 510 characters (n < 510) to the parameter so that the message is less than 512 characters.

Then the preceding PC->SIM character is "Ack", the instructed control command is executed and the SIM returns the following response.

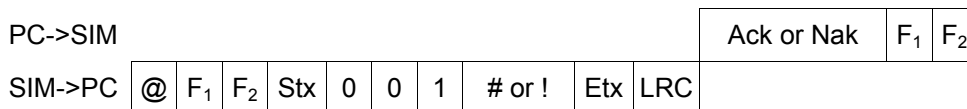

The PC transmits "Ack" or "Nak"; then transmits the next command if necessary.

**5.3.10 Query command in the RS485 multi-point connection**

The query command to be used when a pump operation instruction or a setting change instruction is transmitted from the SIM and is arranged in the order specified below. The top is "?" (HEX code "3F") and ASCII characters corresponding to the respective function code and parameter follow.

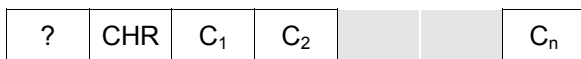

CHR: Function code character, C<sub>1</sub> to C<sub>n</sub>: Parameter.

Parameter (from C<sub>1</sub> to C<sub>n</sub>) serves as 16 bits signed hexadecimal value coded ASCII text. When a message (a space character, a function code, and parameter) exceeds 255 characters, input "?" and CHR to the top transmission block only (the first transmission block of the transmission frame). It is not necessary to input them to the second and succeeding transmission blocks.

The SIM returns the acknowledgment response character "#" when the query command is processed normally. If not, the SIM returns the non-acknowledgment response character "!" and 3 characters of the non-acknowledgment code are added to "!".

Transmission frame when data is transmitted from one block and returned to two blocks.

Designate a query command on the PC.

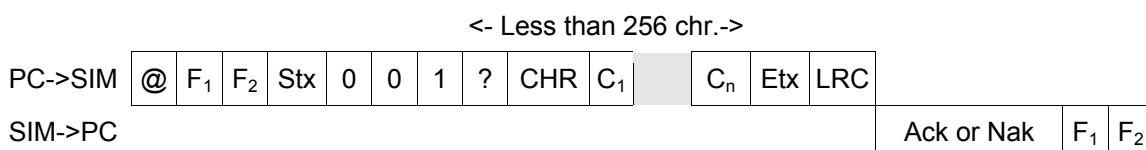

**SCU-1600 Control Unit for Turbomolecular Pump**

Always assign less than 254 characters ( $n < 254$ ) to the parameter so that the message is less than 256 characters.

Next, the preceding SIM->PC character is "Ack", the instructed query command is executed and the SIM returns the following response (1st block).

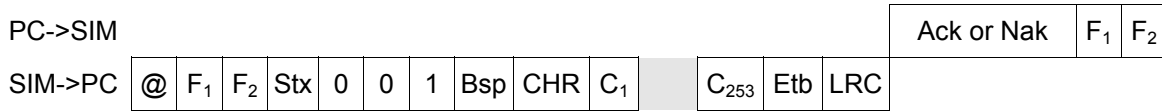

Then "Ack" is sent by the SIM->PC character in reaction to the response (1st block) from the SIM, the SIM returns the following response (2nd block).

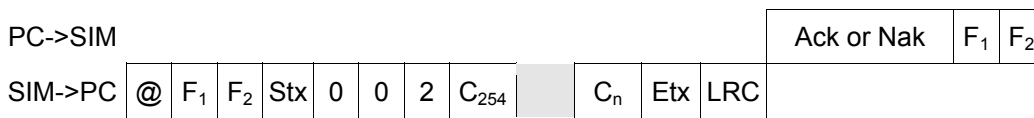

The PC transmits "Ack" or "Nak"; then transmits the next command if necessary.

**5.3.11 Broadcasting command in the RS485 multi-point connection**

The START or STOP of STP pump operation command can be concurrently instructed to all the multi-connected SIMs. Always assign 0 (HEX code "30", "30") to network frame number. Note that there is no response from the respective SIM.

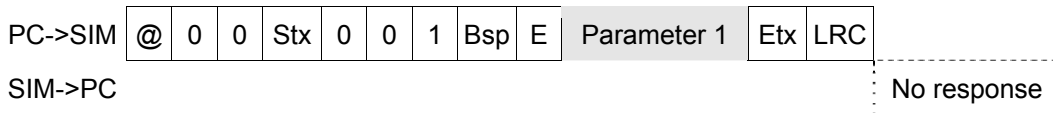

Parameter	Item	Data Format	Remark
1	Pump operation command	8-bits hexadecimal coded ASCII	Refer to Table 21

Pump operation command	Value
START	1
STOP	2

Table 21 - Pump operation commands

**SCU-1600 Control Unit for Turbomolecular Pump**

**5.4 Command specifications**

**5.4.1 Command list**

Function code		Command/Query Name	Function
?	D	ReadMeas	Reads the measured rotational speed.
Bsp	E	Command	Sends commands START, STOP, RESET (valid when MANUAL/REMOTE switch is selected ON.)
?	F	ReadFailMess	Reads the errors being detected.
?	M	ReadModFonct	Reads the pump operation mode and the errors being detected.
?	V	ReadVersion	Reads the software version of the SCU-1600.
?	c	ReadCounters	Reads serial number, hour counter and start counter.
?	d	ReadSetPoint	Reads the setting values of the speed set point and the TMS temperature.
?	e	ReadMotorTemp	Reads the measured motor temperature.
?	f	ReadStatus	Reads the various settings. (Remote mode, TMS function, INHIBIT and optional signal [emergency vent valve]).
?	g	ReadEvents	Reads the error record.
Bsp	h	SetSpeedSetPoint	Changes the speed set point.
?	h	ReadSpeedSetPoint	Reads the speed set point.
?	m	ReadModFonctWithWarning	Reads the pump operation mode, the errors and the warnings being detected
?	[	ReadMeasValue	Reads the TMS temperature, motor temperature and measured rotational speed.
Bsp	0	SetOptions	Changes optional function (Second speed option)
?	0	ReadOptions	Reads optional function (Second speed option)

Table 22 - Command list

5.4.2 ReadMeas

Function: Reads the measured rotational speed.

Transmission frame:

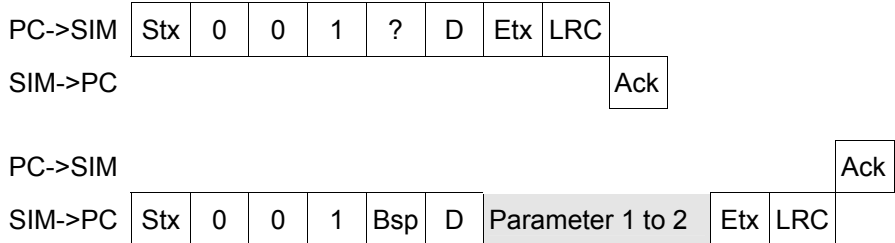

Parameter	Item	Data format	Remarks
1	[System reservation]	56-bits hexadecimal coded ASCII	
2	Measured rotational speed (Unit: Hz)	16-bits hexadecimal coded ASCII	

Example:

Measured rotational speed:  $02DC_{hex} = 732 \text{ Hz} = 43,920 \text{ rpm}$

Parameter	1														2				
ASCII	*1	*1	*1	*1	*1	*1	*1	*1	*1	*1	*1	*1	*1	*1	*1	0	2	D	C
HEX																30	32	44	43

\*1 System reservation

5.4.3 Command

Function: Sends the pump operation commands START, STOP and RESET. These commands function in the same way as when each switch of the SCU-1600 is pressed. They are valid when MANUAL/REMOTE changeover switch on the SCU-1600 is "ON" and when being sent to the serial port which is set as the input operation port in the remote operation mode setting. Refer to Section 3.11, "Parameter set mode".

Transmission frame:

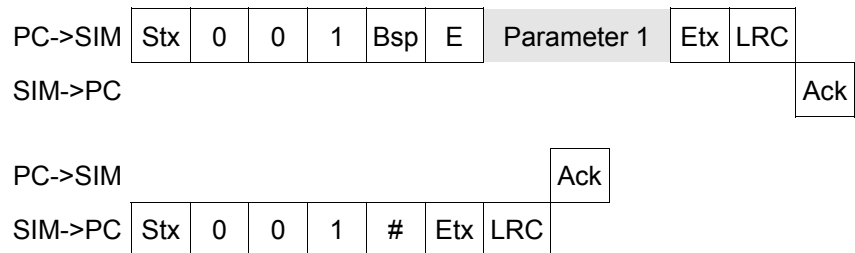

**SCU-1600 Control Unit for Turbomolecular Pump**

Parameter	Item	Data format	Remark
1	Pump operation command	8-bits hexadecimal coded ASCII	Refer to Table 23

Pump operation command	Value
START	1
STOP	2
RESET	4

Table 23 - Pump operation commands

Example:

Pump operation command : RESET operation = 4 = 04<sub>hex</sub>

Parameter	1	
ASCII	0	4
HEX	30	34

**5.4.4 ReadFailMess**

Function: Reads the errors being detected. This data is the same data as that of "ReadModFonct" parameter 2 to 34.

Transmission frame:

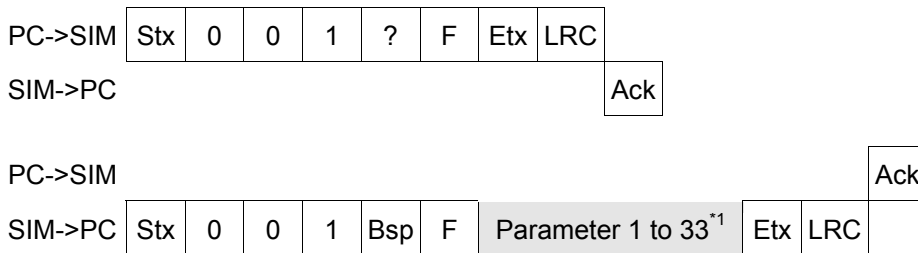

SCU-1600 Control Unit for Turbomolecular Pump

Parameter	Item	Data format	Remarks
1	The number of error	8-bits hexadecimal coded ASCII	Up to 32 errors <sup>*1</sup>
2 to 33 <sup>*1</sup>	Error 1	8-bits hexadecimal coded ASCII	<sup>*2</sup>
	...	...	
	Error 32 <sup>*1</sup>	8-bits hexadecimal coded ASCII	

<sup>\*1</sup> The maximum number of errors may differ depending upon the software version of SCU-1600. It is recommended that an application be designed as variable-length data.

<sup>\*2</sup> Value corresponding to the error message is transmitted, (refer to Table 24 and Table 25). The most recent error has the largest parameter number. When the number of errors being detected is under the maximum number, the value of parameter that is larger than the number of errors being detected is set to 0.

Example:

- The number of error : 02<sub>hex</sub> = 2 errors
- Error 1 : 0D<sub>hex</sub> = 13 = Disturbance Xh
- Error 2 : 0F<sub>hex</sub> = 15 = Disturbance Xb
- Error 3 to 32 : 00<sub>hex</sub> = No error detected

Parameter	1	2	3	4	5	6	7	8	9	10
ASCII	0 2	0 D	0 F	0 0	0 0	0 0	0 0	0 0	0 0	0 0
HEX	30 32	30 44	30 46	30 30	30 30	30 30	30 30	30 30	30 30	30 30

Parameter	11	12	13	[Omitted]					
ASCII	0 0	0 0	0 0	28	29	30	31	32	33
HEX	30 30	30 30	30 30	0 0	0 0	0 0	0 0	0 0	0 0
				30 30	30 30	30 30	30 30	30 30	30 30

**SCU-1600 Control Unit for Turbomolecular Pump**

<b>Error message</b>	<b>Value</b>	<b>Error message</b>	<b>Value</b>
Ram error	0	DSP->PCB Com Fail	33
Eeprom Error	1	PCB->DSP Com Fail	34
TMS Higher Temp	2	TMS Sensor Lost	35
TMS Breaker Trip	3	Tuning Error 1	36
TMS Overheat	4	Tuning Error 2	37
Mains Failure	5	Tuning Error 3	38
Power Supply Failure	6	Tuning Error 4	39
Overspeed 1	7	Tuning Error 5	40
Driver Overvoltage	8	ATMP Failure	41
CAUTION: CNT heat 1	9 <sup>*1</sup>	RTMP Failure	42
CNT Overheat 1	10	Imbalance X_H	43 <sup>*1</sup>
Driver Overcurrent	11	Imbalance X_B	44 <sup>*1</sup>
Driver Overload	12	Imbalance Z	45 <sup>*1</sup>
Disturbance X_H	13	Tuning Error 6	46
Disturbance Y_H	14	Tuning Error 7	47
Disturbance X_B	15	Tuning Error 8	48
Disturbance Y_B	16	Tuning Error 9	49
Disturbance Z	17	Driver Failure	50
Motor Overheat	18	R-Unit Failure	51
CAUTION: CNT Heat 2	19 <sup>*1</sup>	Motor Resistor Lost	52
CNT Overheat 2	20	Driver PWM Trouble	53
T.Cable Disconnected	21	Driver FAN Failure	54
P.Cable Disconnected	22	Driver CPU Error	55
E.Valve Disconnect	23	R-Unit Com. Failure	56
Driver Com. Failure	24	Amp Overcurrent	57
First Damage Limit	25 <sup>*1</sup>	DSP Initialize Fail	58
Second Damage Limit	26	Accel Malfunction	59
START NOT ALLOWED	27	Pump Record Failure	60
Speed Pulse Lost	28	PCB Record Failure	61
Overspeed 2	29	Tuning Error 10	62
Overspeed 3	30	Tuning Error 11	63
M_Temp Sensor Lost	31	Tuning Error 12	64
TMS Lower temp	32	Tuning Error 13	65

Table 24 - Error message values

**SCU-1600 Control Unit for Turbomolecular Pump**

Error message	Value	Error message	Value
Tuning Error 14	66	Aberrant Brake	72
Tuning Error 15	67	Aberrant Accel	73
Tuning Error 16	68	TMS Voltage Mismatch	74
Tuning Error 17	69	Insufficient Supply	75
Tuning Error 18	70	Inordinate Current	76
Tuning Error 19	71		

Table 25 - Error message values (continued)

<sup>\*1</sup> CAUTION or WARNING message. It is not a state of failure. Refer to Section 7 for details. The STP pump will continue to operate after one of these messages is displayed. It is recommended that an application be designed with this in consideration.

**5.4.5 ReadModFonct**

Function: Reads the pump operation mode and the errors being detected. The data of errors being detected reads the same data as that of "ReadFailMess".

Transmission frame:

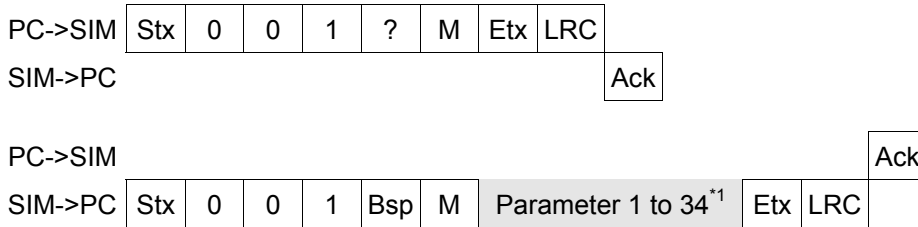

Parameter	Item	Data format	Remarks
1	Pump operation mode	8-bits hexadecimal coded ASCII	Refer to Table 26
2	The number of error	8-bits hexadecimal coded ASCII	Up to 32 errors <sup>*1</sup>
3 to 34 <sup>*1</sup>	Error 1	8-bits hexadecimal coded ASCII	<sup>*2</sup>
	...	...	
	Error 32 <sup>*1</sup>	8-bits hexadecimal coded ASCII	

<sup>\*1</sup> The maximum number of errors may differ depending upon the software version of SCU-1600. It is recommended that an application be designed as variable-length data.

<sup>\*2</sup> Value corresponding to the error message is transmitted (refer to Table 24 and Table 25). The most recent error has the largest parameter number. When the number of errors being detected is under the maximum number, the value of parameter that is larger than the number of errors being detected is set to 0.



**SCU-1600 Control Unit for Turbomolecular Pump**

Pump operation mode	Value
Levitation	1
No Levitation	2
Acceleration	3
Normal	4
Deceleration (Brake)	5
Autotest	6
Tuning	7
Tuning Complete	8
[System Reservation]	9, 10, 11

Table 26 - Pump operation mode

Example:

- Pump operation mode : 01<sub>hex</sub> = 1 = Levitation
- The number of error : 02<sub>hex</sub> = 2 errors
- Error 1 : 0D<sub>hex</sub> = 13 = Disturbance Xh
- Error 2 : 0F<sub>hex</sub> = 15 = Disturbance Xb
- Error 3 to 32 : 00<sub>hex</sub> = No error detected

Parameter	1		2		3		4		5		6		7		8		9		10		11	
ASCII	0	1	0	2	0	D	0	F	0	0	0	0	0	0	0	0	0	0	0	0	0	0
HEX	30	31	30	32	30	44	30	46	30	30	30	30	30	30	30	30	30	30	30	30	30	30

Parameter	12		13		[Omitted]	28		29		30		31		32		33		34	
ASCII	0	0	0	0		0	0	0	0	0	0	0	0	0	0	0	0	0	0
HEX	30	30	30	30		30	30	30	30	30	30	30	30	30	30	30	30	30	30

**SCU-1600 Control Unit for Turbomolecular Pump**

**5.4.6 ReadVersion**

Function: Read the software version of the SCU-1600.

Transmission frame:

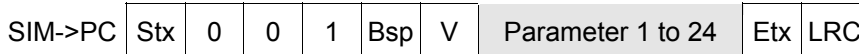
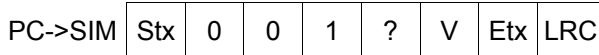

Parameter	Item	Data format	Remarks
1 to 16	Control unit software version	8-bits hexadecimal coded ASCII	
17 to 20	Motor driver software version	4-bits ASCII character	Ver.1.0 = 0100
21 to 24	AMB software version (Digital control loop)	4-bits ASCII character	Ver.41.1.0 = 4110 <sup>*1</sup>

\*1 SCU-1600 uses a digital control loop.

Example:

Control unit software version : 37365F4120312E3020202020202020<sub>hex</sub> = 76\_A 1.0

Motor driver software version : 0100<sub>hex</sub> = 1.0

AMB software version : 4110<sub>hex</sub> = 41.1.0

Parameter	1	2	3	4	5	6	7	8	9	10
	"7"	"6"	"_"	"A"	" "	"1"	."	"0"	" "	" "
ASCII	3 7	3 6	5 F	4 1	2 0	3 1	2 E	3 0	2 0	2 0
HEX	33 37	33 36	35 46	34 31	32 30	33 31	32 45	33 30	32 30	32 30

Parameter	11	12	13	14	15	16	17	18	19	20	21	22	23	24
	" "	" "	" "	" "	" "	" "	/	/	/	/	/	/	/	/
ASCII	2 0	2 0	2 0	2 0	2 0	2 0	0 1	0 0	0 0	4 1	1 1	1 0		
HEX	32 30	32 30	32 30	32 30	32 30	32 30	30 31	30 30	34 31	31 31	30 30			

**SCU-1600 Control Unit for Turbomolecular Pump**

**5.4.7 ReadCounters**

Function: Reads serial number, hour counter and start counter.

Transmission frame:

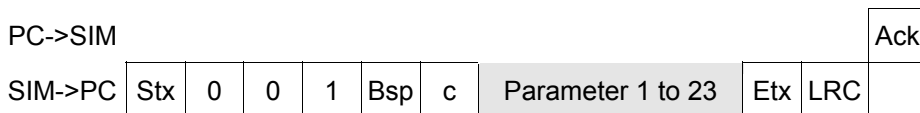
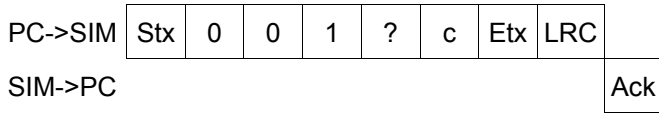

Parameter	Item	Data format	Remarks
1 to 10	Control unit serial number	4-bits ASCII character	
11 to 20	Pump serial number	4-bits ASCII character	
21	Pump hour counter (Unit: minute)	32-bits hexadecimal coded ASCII	
22	Control unit hour counter (Unit: minute)	32-bits hexadecimal coded ASCII	
23	Start counter	32-bits hexadecimal coded ASCII	

Example:

Control unit serial number : 12345  
Pump serial number : 6789A  
Pump hour counter : 0000003C<sub>hex</sub> = 60 minutes = 1 hour  
Control unit hour counter : 0000028C<sub>hex</sub> = 652 minutes =10 hours and 52 minutes  
Start counter : 00000064<sub>hex</sub> = 100 times

Parameter	1	2	3	4	5	6	7	8	9	10	11	12	13	14	15	16	17	18	19	20
ASCII	1	2	3	4	5						6	7	8	9	A					
HEX	31	32	33	34	35	20	20	20	20	20	36	37	38	39	41	20	20	20	20	20

Parameter	21								22								23									
ASCII	0	0	0	0	0	0	3	C	0	0	0	0	0	2	8	C	0	0	0	0	0	0	0	0	6	4
HEX	30	30	30	30	30	30	33	43	30	30	30	30	30	32	38	43	30	30	30	30	30	30	30	30	36	34



**SCU-1600 Control Unit for Turbomolecular Pump**

Parameter	Item	Data format	Remark
1	Motor temperature (Unit: °C)	16-bits hexadecimal coded ASCII	

Example:

Motor temperature : 0014<sub>hex</sub> = 20 °C (68 °F)

Parameter	1			
ASCII	0	0	1	4
HEX	30	30	31	34

**5.4.10 ReadStatus**

Function: Reads various settings (Remote mode, TMS function, INHIBIT, Emergency vent valve).

Transmission frame:

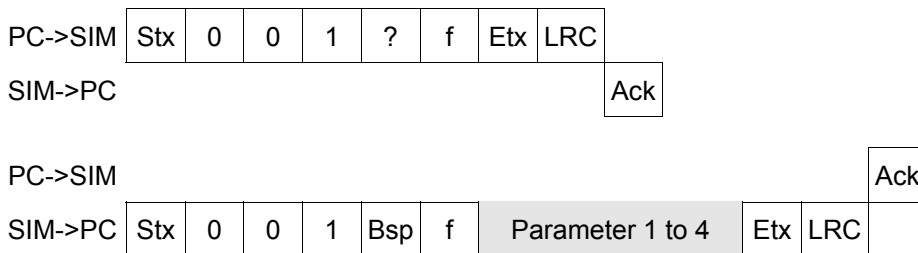

Parameter	Item	Data format	Remarks
1	Remote mode setting	8-bits hexadecimal coded ASCII	Refer to Table 27
2	TMS function setting	8-bits hexadecimal coded ASCII	00 <sub>hex</sub> : ENABLE Excluding 00 <sub>hex</sub> : DISABLE
3	INHIBIT setting	8-bits hexadecimal coded ASCII	00 <sub>hex</sub> : ENABLE Excluding 00 <sub>hex</sub> : DISABLE
4	Emergency vent valve setting	8-bits hexadecimal coded ASCII	00 <sub>hex</sub> : ENABLE Excluding 00 <sub>hex</sub> : DISABLE

Remote mode	Value
I/O Remote	1
COM1	2
COM2	5
STP-Link	6
[System reservation]	3, 4

Table 27 - Remote mode

Example:

- Remote mode setting : 01<sub>hex</sub> = I/O Remote
- TMS function setting : 00<sub>hex</sub> = ENABLE
- INHIBIT setting : FF<sub>hex</sub> = DISABLE
- Emergency vent valve setting : FF<sub>hex</sub> = DISABLE

Parameter	1		2		3		4	
ASCII	0	1	0	0	F	F	F	F
HEX	30	31	30	30	46	46	46	46

#### 5.4.11 ReadEvents

Function: Reads the "Error Record". It has the most recent 10 errors that have been detected.

Transmission frame:

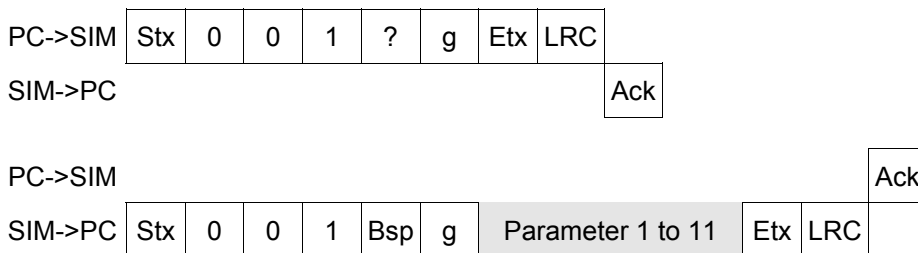

Parameter	Item	Data format	Remarks
1	The number of "Error Record"	8-bits hexadecimal coded ASCII	Up to 10 errors
2 to 11	Error Record 1 to Error Record 10	8-bits hexadecimal coded ASCII	*1

\*1 Value corresponding to the error message is transmitted (refer to Table 21 and 22). The most recent error has the smallest parameter number. When the number of errors being detected is under the maximum number, the value of parameter that is larger than the number of errors has been detected is set to 0.

Example:

When 3 errors have been detected in the past;

- The number of "Error Record" : 03<sub>hex</sub> = 3 errors
- Error Record 1 : 0F<sub>hex</sub> = 15 = Disturbance Xb
- Error Record 2 : 0D<sub>hex</sub> = 13 = Disturbance Xh
- Error Record 3 : 15<sub>hex</sub> = 21 = T.Cable Disconnected
- Error Record 4 to 10 : 00<sub>hex</sub> = No error recorded

Parameter	1	2	3	4	5	6	7	8	9	10	11
ASCII	0 3	0 F	0 D	1 5	0 0	0 0	0 0	0 0	0 0	0 0	0 0
HEX	30 33	30 46	30 44	31 35	30 30	30 30	30 30	30 30	30 30	30 30	30 30

### 5.4.12 SetSpeedSetPoint

Function: Changes the "Speed Set Point" value. This value can be changed in the range from half of the rated rotational speed to the rated rotational speed.

Transmission frame:

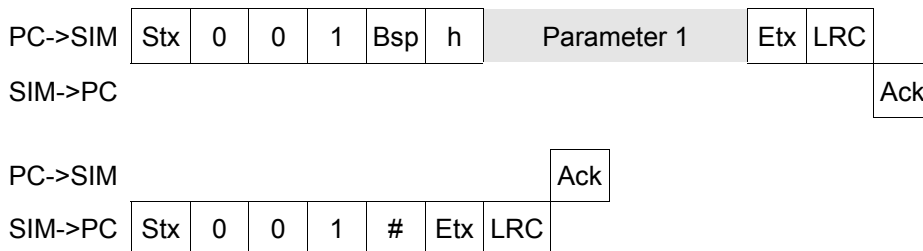

Parameter	Items	Data format	Remark
1	Speed Set Point (Unit: Hz)	16-bits hexadecimal coded ASCII	*1

\*1 When the parameter value is larger than the rated rotational speed, it is automatically set to the rated rotational speed. When the parameter value is smaller than half of rated rotational speed, it is automatically set to half of rated rotational speed. The value of "Speed Set Point" displayed in LCD of SCU-1600 is in increments of 500 rpm.

Example:

Speed Set Point : 01F4<sub>hex</sub> = 500 Hz = 30,000 rpm

Parameter	1			
ASCII	0	1	F	4
HEX	30	31	46	34

### 5.4.13 ReadSpeedSetPoint

Function: Reads the "Speed Set Point" value. This value is the same as "ReadSetPoint" parameter 1 (Speed Set Point).

Transmission frame:

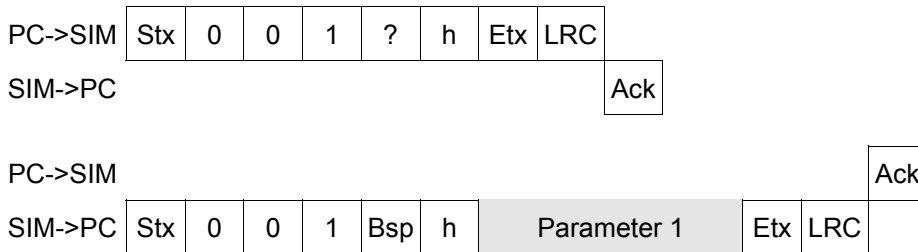

Parameter	Item	Data format	Remark
1	Speed Set Point (Unit: Hz)	16-bits hexadecimal coded ASCII	

Example:

Speed Set Point : 0320<sub>hex</sub> = 800 Hz = 48,000 rpm

Parameter	1			
ASCII	0	3	2	0
HEX	30	33	32	30



**SCU-1600 Control Unit for Turbomolecular Pump**

**5.4.14 ReadModFonctWithWarning**

Function: Reads the pump operation mode, errors and warnings being detected. The data of errors being detected data is the same data as that of "ReadFailMess".

Transmission Frame:

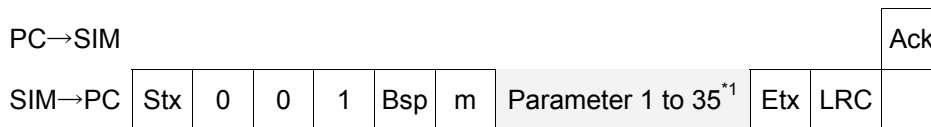
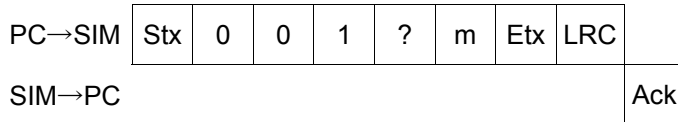

Parameter	Item	Data format	Remark
1	Pump operation mode	8-bits hexadecimal coded ASCII	See Table 26
2	WARNING being detected	16-bits hexadecimal coded ASCII	See Table 28
3	The number of errors detected	8-bits hexadecimal coded ASCII	Up to 32 errors <sup>*1</sup>
4 to 35 <sup>*1</sup>	Error 1	8-bits hexadecimal coded ASCII	<sup>*2</sup>
	...		
	Error 32 <sup>*1</sup>	8-bits hexadecimal coded ASCII	

<sup>\*1</sup> The maximum number of errors may differ depending upon the software version of the SCU-1600. It is recommended that an application be designed as variable-length data.

<sup>\*2</sup> Value corresponding to the error message is transmitted. (see Table 24 and Table 25)

The recent error has the largest parameter number. When the number of errors being detected is under the maximum number, the value of parameter that is larger than the number of errors being detected is set to 0.

**SCU-1600 Control Unit for Turbomolecular Pump**

Bit	Warning message	16-bits hex value
0	WARNING: Bad Pump Transmit	0001
1	WARNING: Second Damage Limit	0002
2	WARNING: First Damage Limit	0004
3	WARNING: Imbalance X_H	0008
4	WARNING: Imbalance X_B	0010
5	WARNING: Imbalance Z	0020
6	WARNING: Pump Run Time Over	0040
7	WARNING: Pump Overload	0080
8	WARNING: Pump record bungle	0100
9	WARNING: PCB record bungle	0200
10	WARNING: Low RTC Battery	0400
11	WARNING: Clock Data is Lost	0800
12	WARNING: Recover by AUX Data	1000
13	[System reservation]	2000
14	[System reservation]	4000
15	[System reservation]	8000

Table 28 - Warning value bit assign



**SCU-1600 Control Unit for Turbomolecular Pump**

Example:

- Pump operation mode : 01<sub>hex</sub> = 1 = Levitation
- WARNING being detected : 0098<sub>hex</sub> = 0008<sub>hex</sub> OR 0010<sub>hex</sub> OR 0080<sub>hex</sub> =  
3 warnings of "WARNING: Imbalance X\_H", "WARNING: Imbalance X\_B" and "WARNING: Pump Overload"
- The number of error : 02<sub>hex</sub> = 2 errors
- Error 1 : 0D<sub>hex</sub> = 13 = Disturbance Xh
- Error 2 : 0F<sub>hex</sub> = 15 = Disturbance Xb
- Error 3 to 32 : 00<sub>hex</sub> = No error detected

Parameter	1		2				3		4		5		6		7		8		9		10	
ASCII	0	1	0	0	9	8	0	2	0	D	0	F	0	0	0	0	0	0	0	0	0	0
HEX	30	31	30	30	39	38	30	32	30	44	30	46	30	30	30	30	30	30	30	30	30	30

Parameter	11		12		13		14		15		30		31		32		33		34	
ASCII	0	0	0	0	0	0	0	0	0	0	0	0	0	0	0	0	0	0	0	0
HEX	30	30	30	30	30	30	30	30	30	30	30	30	30	30	30	30	30	30	30	30

[Omitted]

Parameter	35	
ASCII	0	0
HEX	30	30

5.4.15 ReadMeasValue

Function: Reads the TMS temperature, motor temperature and measured rotational speed. The motor temperature value is the same temperature as "ReadMotorTemp". The measured rotational speed value is the same as "ReadMeas" parameter 2 (Measured rotational speed).

Transmission frame:

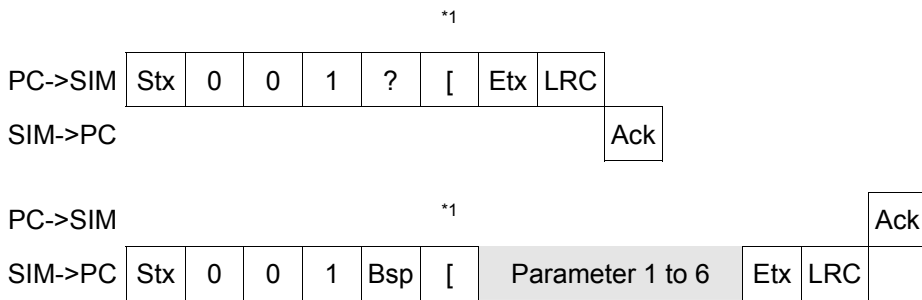

\*1 The HEX code of ASCII character '[' is "5B".

Parameter	Item	Data format	Remark
1	[System reservation]	120-bits hexadecimal coded ASCII	
2	TMS temperature (Unit °C)	16-bits hexadecimal coded ASCII	
3	Motor temperature (Unit °C)	16-bits hexadecimal coded ASCII	
4	[System reservation]	40-bits hexadecimal coded ASCII	
5	Measured rotational speed (Unit: Hz)	16-bits hexadecimal coded ASCII	
6	[System reservation]	64-bits hexadecimal coded ASCII	



**SCU-1600 Control Unit for Turbomolecular Pump**

Example:

TMS temperature:  $3C_{\text{hex}} = 60\text{ }^{\circ}\text{C}$  (140°F)  
 Motor temperature:  $14C_{\text{hex}} = 20\text{ }^{\circ}\text{C}$  (68°F)  
 Measured rotational speed:  $02DC_{\text{hex}} = 732\text{ Hz} = 43,920\text{ rpm}$

Parameter	1																
ASCII	*1	*1	*1	*1	*1	*1	*1	*1	*1	*1	*1	*1	*1	*1	*1	*1	*1
HEX																	

Parameter	1											2			
ASCII	*1	*1	*1	*1	*1	*1	*1	*1	*1	*1	*1	0	0	3	C
HEX												30	30	33	43

Parameter	3				4										5				
ASCII	0	0	1	4	*1	*1	*1	*1	*1	*1	*1	*1	*1	*1	*1	0	2	D	C
HEX	30	30	31	34												30	32	44	43

Parameter	6																
ASCII	*1	*1	*1	*1	*1	*1	*1	*1	*1	*1	*1	*1	*1	*1	*1	*1	*1
HEX																	

\*1 System reservation

**SCU-1600 Control Unit for Turbomolecular Pump**

**5.4.16 SetOptions**

Function: Reads the setting value of optional function. The parameter n depends on the optional function.

Transmission frame:

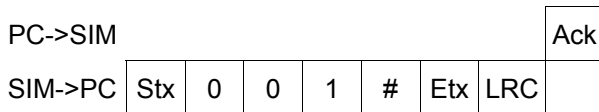
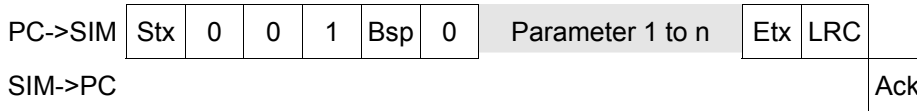

Parameter	Item	Data format	Remark
1	Optional function number	16-bits hexadecimal coded ASCII	see Table 29
2 to n	Function item		

Optional function number	Value	Total parameter n	Remark
Second speed option setting	0014	3	see 5.4.16.1
Second speed selection	0015	2	see 5.4.16.2

Table 29 - Option function number and parameter list

**5.4.16.1 Second speed option setting**

Settings for second speed can be changed.

Parameter	Item	Data format	Remark
1	Optional function number	16-bits hexadecimal coded ASCII	0014 hex
2	Second speed setting (Unit: Hz)	16-bits hexadecimal coded ASCII	*1
3	Second speed option setting	16-bits hexadecimal coded ASCII	0000 hex : DISABLE 00FF hex : ENABLE (parallel port operation) 01FE hex : ENABLE (serial port operation) Others are refused

**SCU-1600 Control Unit for Turbomolecular Pump**

\*1 This value can be changed in the range from half of the rated rotational speed to the rated rotational speed. When the parameter value is larger than the rated rotational speed, it is automatically set to the rated rotational speed. When the parameter value is smaller than half of rated rotational speed, it is automatically set to half of rated rotational speed. The value of "Speed Set Point" displayed in LCD of SCU-1600 is in increments of 500 rpm.

Example:

Second speed setting : 00E1hex = 225 Hz = 13500 rpm

Second speed option setting : 0000hex = DISABLE

Parameter	1				2				3			
ASCII	0	0	1	4	0	0	E	1	0	0	0	0
HEX	30	30	31	34	30	30	45	31	30	30	30	30

**5.4.16.2 Second speed selection**

The normal rating speed setting or second rating speed setting can be selected in the normal state.

When using this function, set the second speed option to the "ENABLE" (serial port operation). (see Section 3.11, "Parameter set mode")

Parameter	Item	Data format	Remark
1	Optional function number	16-bits hexadecimal coded ASCII	0015 hex
2	Second speed selection	16-bits hexadecimal coded ASCII	0000 hex: Normal rating speed setting 0001 hex: Second rating speed setting 0002 hex: [System reservation] 0003 hex: [System reservation] Others are refused

Example:

Second speed selection : 0000<sub>hex</sub> = Normal rating speed setting

Parameter	1				2			
ASCII	0	0	1	5	0	0	0	0
HEX	30	30	31	35	30	30	30	30

### 5.4.17 ReadOptions

Function: Reads the setting value of optional function. The parameter n depends on the optional function.

Transmission frame:

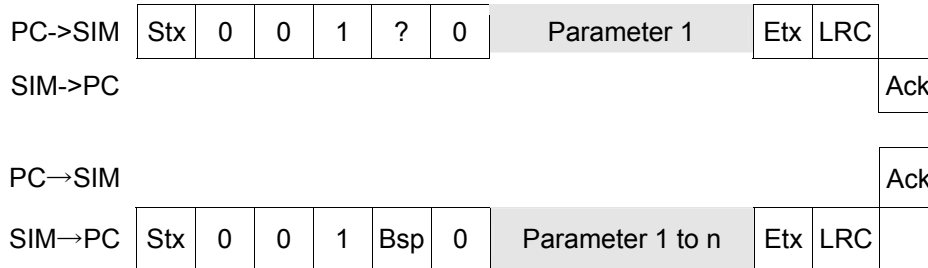

Parameter	Item	Data format	Remark
1	Optional function number (receive/return)	16-bits hexadecimal coded ASCII	see Table 30
2 to n	Function items (return)		

Optional function number	Value	Total response parameter n	Remark
Second speed option setting	0014	4	see 5.4.17.1
Second speed selection	0015	2	see 5.4.17.2

Table 30 - Option function number and parameter list

#### 5.4.17.1 Second speed function setting

Settings for second speed can be changed.

Parameter	Item	Data format	Remark
1	Optional function number	16-bits hexadecimal coded ASCII	0014 hex
2	Second speed setting (Unit: Hz)	16-bits hexadecimal coded ASCII	
3	Second speed option setting	16-bits hexadecimal coded ASCII	0000 hex : DISABLE 00FF hex : ENABLE (parallel port operation) 01FE hex : ENABLE (serial port operation)
4	Selected speed value (Unit: Hz)	16-bits hexadecimal coded ASCII	



**SCU-1600 Control Unit for Turbomolecular Pump**

Example:

Second speed setting : 00E1<sub>hex</sub> = 225 Hz = 13500 rpm  
 Second speed option setting : 0000<sub>hex</sub> = DISABLE  
 Selected speed value : 01C2<sub>hex</sub> = 450 Hz = 27000 rpm (Normal rating speed setting)

Parameter	1				2				3				4			
ASCII	0	0	1	4	0	0	E	1	0	0	0	0	0	1	C	2
HEX	30	30	31	34	30	30	45	31	30	30	30	30	30	31	43	32

**5.4.17.2 Second speed select**

The speed setting set as rotational speed in the normal state can be read.

Parameter	Item	Data format	Remark
1	Option function number	16-bits hexadecimal coded ASCII	0015 hex
2	Second speed selection	16-bits hexadecimal coded ASCII	0000 hex: Normal rating speed setting 0001 hex: Second rating speed setting

Example:

Second speed selection : 0000<sub>hex</sub> = Normal rating speed setting

Parameter	1				2			
ASCII	0	0	1	5	0	0	0	0
HEX	30	30	31	35	30	30	30	30



---

*SCU-1600 Control Unit for Turbomolecular Pump*

5

**SERIAL COMMUNICATION PROTOCOL**

This page intentionally blank.

## 6 STP-Link

The "STP-Link" is a Windows application for operating the STP pump, confirming the pump status or setting various settings. Table 31 shows the principal functions.

See the Instruction Manual of the "STP-Link" for the detailed specification and operating method.

Item	Functions
Confirmation function	Software version
	Pump serial number
	Control unit serial number
	STP pump model
Communication specification setting function	Remote operation mode setting
	Each serial port setting
Option setting function	Rotational speed setting
	TMS setting
	Rotation inhibit signal setting
	Emergency vent valve setting
	Warning function setting
History confirmation function	Confirmation of pump operation hours
	Confirmation of control unit operation hours
	Confirmation of damage integrated value
	Confirmation of error history
Record function	Record of setting

Table 31 - Functions of STP-Link



---

*SCU-1600 Control Unit for Turbomolecular Pump*

6

STP-LINK

This page intentionally blank.

## 7 MAINTENANCE

The SCU-1600 is provided with safety functions for various abnormalities/errors. If an abnormality/error is found when using the STP pump, check it and take measures in accordance with the following procedures. If you cannot trace it or if the STP pump does not function normally after the troubleshooting, fill in the necessary information in the "Return Declaration" and fax it to Service office.

### 7.1 Safety functions

#### 7.1.1 Power failure

When the power voltage drops below 80 V due to a power failure or another fault, the normal operation of the magnetic bearing is maintained at the high rotational speed using the regenerative energy of the rotating rotor (backup operation during a power failure).

The lowest rotational speed to which the magnetic bearing can operate at a power failure is called a backup rotational speed. The lowest backup rotational speeds vary according to the model of STP pump used, refer to Table 32.

1. When the rotational speed is at backup rotational speed or more at a power failure:  
 The SCU-1600 detects any power failure of 2 seconds or more and the STP pump decelerates. At this time, the "POWER" LED extinguishes and the "FAILURE" LED illuminates. The LCD displays "Mains Failure". An alarm signal is output from REMOTE X7 pins (14)-(33) and (15)-(33). When the rotational speed reaches the backup rotational speed, the rotor lands on the touch down bearing and stops. The "FAILURE" LED extinguishes and the LCD is turned off. The alarm signal output is reset.  
 The SCU-1600 does not detect a power failure of less than 2 seconds and the STP pump will continue to rotate.
2. When the rotational speed is less than backup rotational speed at a power failure:  
 The SCU-1600 does not detect the power failure. The rotor lands on the touch down bearing and stops.

Connected pump	Backup rotational speed
STP-A2203 series	Approximately 6,000 rpm
STP-A2503/A3003 series	Approximately 6,000 rpm
STP-A2803/A3503 series	Approximately 5,000 rpm
STP-F2203 series	Approximately 6,000 rpm
STP-XH2603/XH3203 series	Approximately 6,000 rpm
STP-XA2703/XA3203 series	Approximately 6,000 rpm
STP-XA4503 series	Approximately 6,000 rpm
STP-XW3503 series	Approximately 6,000 rpm

Table 32 - Backup rotational speed

**SCU-1600 Control Unit for Turbomolecular Pump**

Table 33 shows the status of LCD, LEDs, and REMOTE output signals at a power failure.

Rotational speed	Duration of power failure	LCD	LEDs		REMOTE output signal (REMOTE X7)		
		Error messages	POWER LED	FAILURE LED	POWER	ALARM	
						N.O.	N.C.
Backup rotational speed or more	Approx. 2 sec. or more	Mains Failure	Extinguish	Illuminate	Open	Close	Open
	Less than approx. 2 sec.	Continues as before					
Less than backup rotational speed	X	OFF	Extinguish	Extinguish	Open	Open	Close

Table 33 - States of LCD, LEDs and REMOTE output signals at a power failure

**7.1.2 Operation after a power recovery**

1. The STP pump continues decelerating, and power failure detection is reset automatically.

At this time, the "POWER" LED illuminates and the "FAILURE" LED extinguishes. Also, POWER OUT pins (9)–(28) is closed, and a failure signal is reset between ALARM OUT pins (14)–(33) and (15)–(33) of the "X7 REMOTE" connector.

2. When the START operation is performed after a power recovery, the STP pump reaccelerates even while it is in BRAKE state.

However, the SCU-1600 may detect excessive vibration when power is recovered after the rotor lands on the touch down bearing (see Section 7.1.4). In this case, the STP pump once stops and cannot reaccelerate until the RESET operation completed (see Section 4.5.7).

*Note: It is recommended to establish a procedure so that the power can be supplied to the SCU-1600 immediately after a power recovery.*

### 7.1.3 Abnormal state of magnetic bearing

CAUTION

When an abnormality/error occurs in the magnetic bearing, check the STP pump as well as the SCU-1600.  
If "FAILURE" cannot be released after reset operation, contact Service office.

When the magnetic bearing does not function normally due to a breakage of the STP connection cable, disconnection of connectors or any abnormality/error of the STP control circuit, the rotor lands on the touch down bearing and stops. The "FAILURE" LED illuminates and the LCD displays error message "Disturbance \*".

### 7.1.4 Excessive vibration

When serious vibration or mechanical shock causes the rotor to come in contact with the touch down bearing (due to external vibration/impact, intrusion of atmosphere or foreign matter into the STP pump or rotor imbalance), the STP pump decelerates and stops.

The "FAILURE" LED illuminates and the LCD displays error message "Disturbance \*".

### 7.1.5 Motor driver overload

When the STP pump does not attain the rated speed within approximately 30 minutes after starting or when the ACCELERATION state remains unchanged during operation for approximately 30 minutes, the STP pump decelerates and stops.

The "FAILURE" LED illuminates and the LCD displays error message "Driver Overload".

### 7.1.6 Overheating inside the STP pump

When the motor inside the STP pump overheats due to an abnormal high temperature or overload operation, the STP pump decelerates and stops.

The "FAILURE" LED illuminates and the LCD displays error message "Motor Overheat".

### 7.1.7 Overheating inside the SCU-1600

The temperature in the SCU-1600 increases when the ventilating duct is blocked or the ambient temperature is high. The LCD displays error message "CAUTION : CNT heat\*" when the inside of the SCU-1600 overheats. In this case, the pump does not stop.

When the SCU-1600 overheats continuously, the STP pump decelerates and stops.

The "FAILURE" LED illuminates and the LCD displays error message "CNT Overheat \*".

### 7.1.8 Overspeed

When the rotational speed of the STP pump exceeds the specified rotational value due to a failure in the motor driver, the MAIN POWER on the SCU-1600 switches "OFF". The STP pump has no power supplied, decelerates and stops.

The "FAILURE" LED illuminates and the LCD displays error message "Overspeed \*".

### 7.1.9 Abnormality/Error in the TMS unit (for use with the TMS unit)

If the temperature of the STP pump base unit is higher than the setting value by 10 °C (18 °F) or more due to the occurrence of an abnormality/error in the TMS heater or other fault, the "FAILURE" LED illuminates and the LCD displays error message "TMS Higher Temp". The heater is switched OFF and the cooling water unit is operated. The STP pump decelerates and stops. Continue to operate the cooling water unit while "TMS Higher Temp" is displayed after the pump stops.

If the temperature of the STP pump base unit is lower than the setting value by 10 °C (18 °F) or more due to the occurrence of an abnormality/error in the TMS heater or other fault, the "FAILURE" LED illuminates and the LCD displays the error message "TMS Lower Temp". The heater and the cooling water valve are switched OFF and the STP pump decelerates and stops.

*Note: "TMS Lower Temp" is not detected for a certain time when the STP pump starts.*

When an abnormality/error occurs in the TMS connection cable, the STP pump decelerates and stops. The heater and the cooling water unit are switched OFF.

The "FAILURE" LED illuminates and the LCD displays the error message "T.Cable Disconnect".



**SCU-1600 Control Unit for Turbomolecular Pump**

**7.2 "WARNING" message function**

**7.2.1 "WARNING" message display function**

The SCU-1600 is provided with a "WARNING" message to display when an overhaul is needed following a self test. When a "WARNING" appears in the upper left hand corner of the LCD, press the "ENTER" switch to display the warning message for seconds (The "ENTER" switch can also be used in REMOTE mode).

The warning signal is output from the remote output terminal of the remote connector X7 while the alert message is displayed. (see Table 9)

Example:

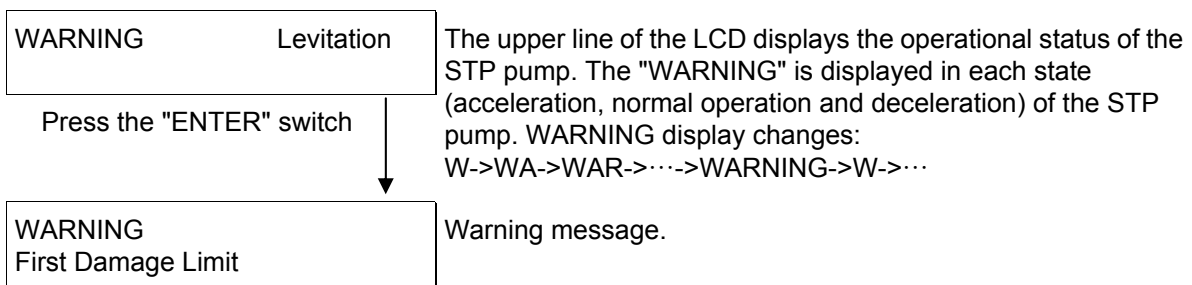

*Note: The "WARNING" message cannot be reset by the "RESET" switch. See Section 7.3, "WARNING message description" for the resetting the "WARNING" message. The STP pump can operate even when the "WARNING" message is displayed except when the "Second Damage Limit" is displayed.*

**SCU-1600 Control Unit for Turbomolecular Pump**

**7.3 "WARNING" message description**

**7.3.1 Damage point function**

Impact of the STP pump rotor onto the touch-down bearing, such as by an unexpected in-rush of air from outside or in the event of power failure, can damage the touch-down bearings. The SCU-1600 monitors these impacts and assigns damage points to the event of "Disturbance" or "Mains Failure". The damage point increases with the rotational speed up to 15 point for each "Disturbance", and 1 point for each touch-down at "Mains Failure".

Refer to Section 3.10, "Confirmation Mode" about confirmation method of damage point.

STP pump	Warning message	
	First Damage Limit	Second Damage Limit
STP-A2203 series STP-A2503/A3003 series STP-F2203 series	120 or more	150 or more
STP-A2803/A3503 series STP-XA2703/A3203 series STP-XA4503 series STP-XW3503 series	45 or more	60 or more
STP-XH2603/XH3203 series	72 or more	90 or more

Table 34 - Accumulated damage point and warning message

**7.3.2 First damage limit**

"First Damage Limit" is displayed when the accumulation point attains the setting value shown in Table 34. The rotating operation can be performed though "WARNING" message is displayed. It is recommended to have the STP pump overhauled as soon as possible.

**7.3.3 Second damage limit**

"Second Damage Limit" is displayed when continuing to operate the STP pump after "First Damage Limit" is displayed and the accumulation of the damage point attains the setting value by further "Disturbance" and "Mains Failure".

Overhaul the STP pump because the STP pump cannot perform the rotational operation when "Second Damage Limit" is displayed.

When operating the STP pump is needed after "Second Damage Limit" is displayed, disable the "Second Damage Limit". The rotating operation can be performed even though the "WARNING" message is displayed. Refer to Section 3.11 for the setting method.

### 7.3.4 Imbalance X\_H, X\_B, Z

Imbalance of the rotor of the STP pump is always monitored. Either "Imbalance X\_H", "Imbalance X\_B" or "Imbalance Z" is displayed when imbalance of the synchronized rotor with the rotational speed exceeds the setting value.

When the deposit accumulates in the STP pump, with the increase of the STP pump operation hours, the rotor balance is lost and the imbalance increases gradually. An increase in the amount of deposit may lead to a malfunction of the STP pump. Perform the overhaul ahead usual case.

The setting value of the imbalance is fixed, and the user cannot set it.

Set the "WARNING" function of the Enable/Disable to disable to release the "Imbalance X\_H", "Imbalance X\_B" or "Imbalance Z". (see Section 3.11, "Parameter Set Mode")

### 7.3.5 Pump run time over

The totalising counter adding up the rotation hours is installed in the SCU-1600.

The counter value can be confirmed on the LCD. (see Section 3.10, "Confirmation Mode")

"Pump Run Time Over" is displayed when the counter value attains the setting value. When deposit accumulates inside the STP pump, this function can be used to consider the time of the overhaul. The setting value is user-definable. Refer to Section 3.11, "Parameter Set Mode" for the setting method. "Pump Run Time Over" warning can be reset by setting the warning function to disable after it is occurred. (see Section 3.11, "Parameter Set Mode")

### 7.3.6 Pump overload

"Pump Overload" is displayed when the state that the motor current exceeding the setting value continues during the fixed time. The state that the STP pump rotational speed drops below the setting value continues during the fixed time. However, the motor current and the rotational speed are monitored only in the NORMAL state.

When the deposit accumulates in the STP pump, the load in NORMAL state may gradually grow with the operating time. Considering the time of the overhaul, this "WARNING" function can be used.

The current setting value and rotational speed setting value are user-definable. "Pump Overload" warning can be released by setting the warning function to disable after it is occurred. (see Section 3.11, "Parameter Set Mode")

**SCU-1600 Control Unit for Turbomolecular Pump**

**7.3.7 Low RTC battery**

The lithium battery for the display function of the date/time is installed in the SCU-1600. "Low RTC Battery" is displayed when the decrease in the voltage of the battery is detected.

The STP pump can operate though some failure occurs such as the time of the error history is not correct when the voltage of the battery is low.

"Low RTC Battery" message cannot be released without exchanging the battery.

Contact us when exchanging the battery. The decomposition of the SCU-1600 is necessary.

**SCU-1600 Control Unit for Turbomolecular Pump**

**7.4 "WARNING" function setting**

The following "WARNING" functions can be set to Enable or Disable. Refer to Section 3.11, "Parameter Set Mode" for the setting method. See Table 35 and Table 36 for the default setting.

Message	Default setting	User setting	User setting change (threshold)
WARNING First Damage Limit	Enable	Enable	Disable
WARNING Second Damage Limit	Enable	Enable	Disable
WARNING Imbalance X_H, Imbalance X_B, Imbalance Z	Enable	Enable	Disable
WARNING Pump Run Time Over	Disable	Enable	Enable
WARNING Pump Overload	Disable	Enable	Enable
WARNING Low RTC Battery	Enable	Disable	Disable

Table 35 - Default setting of "WARNING" function

Message	Default setting		User setting	User setting change (threshold)
WARNING Pump Run Time Over	0 hour		0 to 30 million hours	It can be set in units of 100 hours. 0 is not counted.
WARNING Pump Overload	Motor current	100%	0 to 100%	The ratio to the rated current value. Smaller value has high possibility to get "WARNING".
	Rotational speed	0%	0 to 100%	The rate to the rated current value. Larger value has high possibility to get "WARNING".

Table 36 - Factory setting and variable range

**SCU-1600 Control Unit for Turbomolecular Pump**

**7.5 Error at self test state**

When an abnormality/error occurs during the self test while operating the ON switch, the safety function operates, the "FAILURE" LED illuminates and an alarm signal is output from the REMOTE X7 connector (see Table 9). An error message showing "CAUTION" on the upper line and the contents of the error are displayed on the lower line of the LCD. If an abnormality/error is found, take measures in accordance with Table 37.

<b>LCD Messages</b>	<b>Probable causes</b>	<b>Countermeasures</b>	<b>Referred section</b>
CAUTION Coupling is Changed	The different STP pump is used after the tuning is performed.	Perform tuning.	Section 4.2.2 Section 3.9.1
CAUTION Different Pump ID	Failure of the SCU-1600 or STP pump.	Contact Service office.	
CAUTION PCB is Initialized	Failure of the SCU-1600.	Contact Service office.	
CAUTION Pump is Initialized	Failure of the SCU-1600 or STP pump.	Contact Service office.	
CAUTION Pump Type is Changed	The STP pump of a different model is used after the tuning is performed.	Perform tuning.	Section 4.2.2 Section 3.9.1
CAUTION Pump&PCB are Initialized	Failure of the SCU-1600 or STP pump.	Contact Service office.	
CAUTION PumpType is Mismatch	The inappropriate STP pump is used.	Confirm if the appropriate STP pump is connected.	Section 2.1
CAUTION Tuning Error 1 : : Tuning Error 9	Tuning failure	After turning OFF and ON, perform tuning. If the RESET operation does not reset error message, contact Service office.	Section 3.9.1
Motor Resistor Lost	Motor resistance measurement is impossible.	After turning OFF, connect the STP motor connection cable correctly. Perform tuning after power ON operation. If the RESET operation does not reset error message, contact Service office.	3.9.1 3.6.1 3.3
CAUTION Tuning Not Completed	Turning is not completed.	Perform tuning.	Section 3.9.1
Please contact a service centre	The control parameter is not in the memory of the STP pump.	Contact Service office.	

Table 37 - Error messages at self test state

**7.5.1 Error after self test**

If an abnormality/error occurs after the self test, the safety function operates, the "FAILURE" LED and an alarm signal is output from the REMOTE X7 connector (see Table 9). An error message showing the number of the error in the form "Error n° \*\*/\*\*" and the contents of the error are displayed alternately on the lower line of the LCD.

**7.5.2 Error messages**

The first number of "\*\*/\*\*" is the order of detected errors (the earliest error is number 1) and the second number shows the number of errors that have occurred. Thus, a "1/3" would denote the earliest error of 3 errors. Press the "UP" or "DOWN" switch to scroll through the LCD display menu to view the contents of the next or previous error message. (The "UP" or "DOWN" switch can also be used in REMOTE mode)

Example:

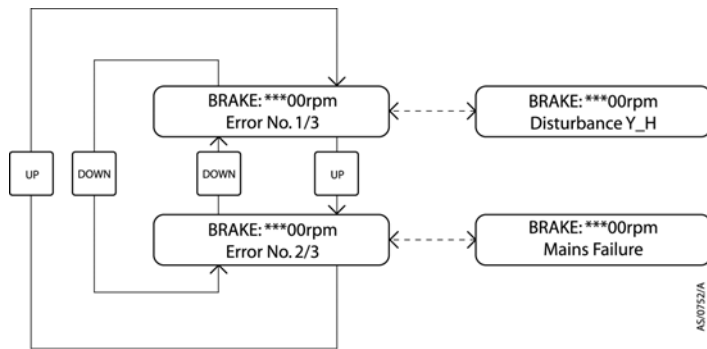

*Note: The upper message on the LCD shows the current STP pump operation state. The lower message on the LCD is alternately displayed.*

**7.5.3 Troubleshooting immediately after power failure occurs**

It is recommended to establish a procedure so that the power can be supplied to the SCU-1600 immediately after a power recovery.

7.5.4 Troubleshooting immediately after other abnormality/errors occur

	<b>WARNING</b>
<p>When disconnecting cables from the STP pump and/or the SCU-1600 to perform troubleshooting and take the necessary action, confirm that the STP pump has stopped, power off the primary power (turn the MAIN POWER "OFF") and isolate (Lockout/Tagout) the electrical energy source water and gas and other energy sources on the vacuum equipment. Failure to do so may result in the inadvertent rotation of the STP pump which may result in an accident, an electric shock or damage to equipment. Moreover, an accident caused by water leaks or gas leak may occur.</p>	

<b>CAUTION</b>
<p>If the RESET operation does not extinguish the "FAILURE" LED, confirm that the STP pump has stopped, turn OFF the primary power (Switch the MAIN POWER "OFF"), then turn ON the primary power again (turn the MAIN POWER "ON").</p>

Refer to Section 4.5.7.

- After confirming the "BRAKE" LED has extinguished and the STP pump stops, remove the probable cause of the abnormality. When the LCD displays an error message, take the necessary action according to Table 38 to Table 44.
- Perform the RESET operation, to turn off the "FAILURE" LED.
- Perform the START operation. Check if the STP pump operates correctly.



SCU-1600 Control Unit for Turbomolecular Pump

LCD Messages	Occurrence condition	Pump operation	Probable causes	Countermeasures	Referred section
Aberrant Accel	Rotational speed rises when deteriorating or stopping.	Decelerate and stop, then Touch down. The magnetic bearing output stops and the rotor is descended on the protection bearing.	Atmospheric air flows the STP pump.	Check the vacuum piping system for leakage. Check the exhaust sequence.	
Aberrant Brake	When the rated operation does not stop approx. 30 min. after start operation is executed.	Free run. <sup>*1</sup>	Failure of the SCU-1600.	Contact Service office.	
Accel Malfunction	Accelerate up to 500 rpm or less.	Stop	1. Malfunction by external noise. 2. Failure of the SCU-1600.	1. Turn on the power after resetting. 2. Contact Service office.	
Amp Overcurrent	Excessive magnetic bearing electric current.	Touch down. The magnetic bearing output stops and the rotor is descended on the protection bearing.	Short-circuit or ground fault in the connection cable or at the connector part.	Contact Service office.	
CAUTION: CNT heat1	Overheat inside the SCU-1600.	Continuance of rotation.	1. High ambient temperature. 2. Insufficient cooling of the SCU-1600.	1. Set the ambient temperature to 40 °C (104 °F) or less. 2. Remove obstacle from the ventilation port.	3.4.1 3.4.3
CNT Overheat 1	Overheat inside the SCU-1600.	Decelerate and stop.	3. High ambient temperature. 4. Insufficient cooling of the SCU-1600.	1. Set the ambient temperature to 40 °C (104 °F) or less. 2. Remove obstacle from the ventilation port.	3.4.1 3.4.3

<sup>\*1</sup> The driver output stops and the rotor continue rotating by inertia. It may take several hours to stop. To stop the STP pump quickly, close the vacuum valve at the outlet port flange and introduce gas from the purge port into the STP pump.

Table 38 - Error messages after self test



SCU-1600 Control Unit for Turbomolecular Pump

LCD Messages	Occurrence condition	Pump operation	Probable causes	Countermeasures	Referred section
Disturbance X_B Disturbance X_H Disturbance Y_B Disturbance Y_H Disturbance Z	Excessive imbalance.	Contact noise and vibration of the rotor are generated from the STP pump. Decelerate and stop.	Abnormal magnetic bearing: 1. Change of the cable length. 2. Disconnection of the STP connection cable or control circuit error.  Excessive vibration applied externally to the STP pump: 1. External vibration/impact. 2. Atmospheric air flows into the STP pump. 3. Foreign matter falls into the STP pump.	1. When changing the cable length, perform tuning. 2. Contact Service office.  1. Remove external vibration so as not to transmit it to the STP pump. 2. Check the vacuum piping. 3. Install the STP pump in a way that no foreign matter falls into the STP pump.	3.9  Instruction Manual(A)
Driver Com Failure	Failure of serial communication.	Decelerate and stop.	Failure of the SCU-1600.	Contact Service office.	
Driver CPU Error	Abnormal CPU operation.	Free run. <sup>*1</sup>	Failure of the SCU-1600.	Contact Service office.	
Driver Failure	Abnormal driver operation.	Decelerate and stop.	Failure of the SCU-1600.	Contact Service office.	
Driver FAN Failure	Cooling fan come to a stop.	Decelerate and stop.	1. Wear-out of the cooling water bearing. 2. Failure of the cooling fan drive circuit.	1. Contact Service office. 2. Contact Service office.	
Driver Overcurrent	Driver over current.	Free run. <sup>*1</sup>	1. Short of the STP connection cable. 2. STP pump failure.	1. Contact Service office. 2. Contact Service office.	

\*1 The driver output stops and the rotor continues rotating by inertia. It may take several hours to stop. To stop the STP pump quickly, close the vacuum valve at the outlet port flange and introduce gas from the purge port into the STP pump.

Table 39 - Error messages after self test (continued)

SCU-1600 Control Unit for Turbomolecular Pump

LCD Messages	Occurrence condition	Pump operation	Probable causes	Countermeasures	Referred section
Driver Overload	ACCELERATION state continues for approximately 30 minutes.	Decelerate and stop.	1. High pressure at the inlet port. 2. High pressure at the outlet port. 3. Leakage of the piping system. 4. Failure of the backing-pump.	1. Use the maximum working pressure or less. Use the allowable backing pressure or less. 3. Check the vacuum piping system for leakage. 4. Check the backing-pump for its capacity and START state. (use a backing-pump with the recommended capacity or more) Contact Service office.	Instruction Manual(B)
Driver Overvoltage	Driver overvoltage.	Free run. <sup>*1</sup>	Failure of the SCU-1600.	Contact Service office.	
Driver PWM Trouble	Failure of the driver circuit.	Free run. <sup>*1</sup>	Failure of the SCU-1600.	Contact Service office.	
DSP Initialize Fail	Abnormal CPU operation.	Touch down. The magnetic bearing output stops and the rotor is descended on the touch down bearing.	Failure of the SCU-1600.	Contact Service office.	
DSP->PCB Com Fail	Serial communication failure.	Decelerate and stop.	Failure of the SCU-1600.	Contact Service office.	
E.valve disconnect	Disconnection of the emergency valve cable.	Decelerate and stop.	1. Disconnection of the emergency vent valve cable. 2. Incorrect setting of the emergency vent valve.	1. Connect the cable correctly. If the cable is not locked, lock it securely. 2. Set "Leak Valve Option" to "DISABLE".	3.11

<sup>\*1</sup> The driver output stops and the rotor continues rotating by inertia. It may take several hours to stop. To stop the STP pump quickly, close the vacuum valve at the outlet port flange and introduce gas from the purge port into the STP pump.

Table 40 - Error messages after self test (continued)

LCD Messages	Occurrence condition	Pump operation	Probable causes	Countermeasures	Referred section
Inordinate Current	Excessive magnetic bearing electric current continues for 30 sec.	Touch down. The magnetic bearing output stops and the rotor is descended on the touch down bearing.	1. Failure of the STP pump. 2. Failure of the SCU-1600.	1. Contact Service office. 2. Contact Service office.	
Insufficient Supply	Connection of the STP pump not corresponding to the input power supply (100 V).	Touch down. The magnetic bearing output stops and the rotor is descended on the touch down bearing.	Incorrect connection of the input power supply.	Change the AC input voltage 200 V.	
M_Temp Sensor Lost	Disconnection of the temperature sensor of the STP pump.	Decelerate and stop.	Failure of the STP pump.	Contact Service office.	
Mains Failure	Insufficient power supply.	Decelerate and stop.	1. Power failure. 2. Incorrect connection of the power cable. 3. Failure of the power cable. 4. Insufficient power supply voltage.	1. Check whether or not a power failure has occurred. 2. Connect the power cable correctly. 3. Replace the power cable. 4. Set the voltage to the rated voltage±10%.	7.1.1 3.6.3 Section 3.6.3 Section 2.1
Motor Overheat	Overheating inside the STP pump.	Decelerate and stop.	1. Overheating during baking. 2. Insufficient cooling. 3. Leakage of the vacuum piping system. 4. Repetition start/stop operations.	1. Set the temperature of the baking heater to 120 °C (248 °F) or less. 2. At the time of baking or gas pumping, always cool the STP pump. 3. Check the piping system for leakage. 4. Repetitions start/stop operations may cause the STP pump to overheat.	Instruction manual(B) Instruction manual(B) 4.1.1 4.1.2

Table 41 - Error messages after self test (continued)

SCU-1600 Control Unit for Turbomolecular Pump

LCD Messages	Occurrence condition	Pump operation	Probable causes	Countermeasures	Referred section
Motor Resistor Lost	Motor resistance measurement is impossible.	Touch down. The magnetic bearing output stops and the rotor is descended on the touch down bearing. Rotation is inoperative.	<ol style="list-style-type: none"> <li>1. Incorrect connection of the STP motor connection cable.</li> <li>2. Failure of the STP motor connection cable.</li> <li>3. Failure of the STP pump.</li> <li>4. Failure of the SCU-1600.</li> </ol>	Turn OFF, and connect the STP motor connection cable correctly. Perform tuning after power ON operation. When the error is displayed after tuning, contact Service office.	3.6.1 3.9.1
Overspeed 1 Overspeed 2 Overspeed 3	Rotational speed exceeds rated speed.	Breaker OFF. Decelerate and stop.	Failure of the SCU-1600.	Contact Service office.	
P.Cable Disconnected	Disconnection of the STP connection cable.	Touch down. The magnetic bearing output stops and the rotor is descended on the touch down bearing.	<ol style="list-style-type: none"> <li>1. Incorrect connection of the STP connection cable.</li> <li>2. Failure of the STP connection cable.</li> </ol>	<ol style="list-style-type: none"> <li>1. Connect the cable correctly. If the cable is not locked, lock it securely.</li> <li>2. Contact Service office.</li> </ol>	3.6.1
PCB Record Failure	Failure of record in memory.	Decelerate and stop.	Failure of the SCU-1600.	Contact Service office.	
PCB->DSP Com Fail	Failure of serial communication.	Decelerate and stop.	Failure of the SCU-1600.	Contact Service office.	
Power Supply Failure	Abnormal power circuit.	Decelerate and stop.	Failure of the SCU-1600.	Contact Service office.	
Pump Record Failure	Failure of record in memory.	Decelerate and stop.	Failure of the STP pump.	Contact Service office.	
Ram Error	Abnormal memory.	Decelerate and stop.	Failure of the SCU-1600.	Contact Service office.	
R-Unit Com Failure	Failure of serial communication.	Decelerate and stop.	Failure of the SCU-1600.	Contact Service office.	

Table 42 - Error messages after self test (continued)

LCD Messages	Occurrence condition	Pump operation	Probable causes	Countermeasures	Referred section
R-Unit Failure	Abnormal board connection.	Decelerate and stop.	Failure of the SCU-1600.	Contact Service office.	
Second Damage Limit	When the extent of the damage on the touch down bearing exceeds the second damage limit.	Decelerate and stop.	Frequency of "Disturbance" or "Mains Failure" error.	Overhaul is needed. Contact Service office.	
Speed Pulse Lost	Abnormal rotational speed detection.	Free run <sup>*1</sup>	1. STP pump failure. 2. Failure of the SCU-1600.	1. Contact Service office. 2. Contact Service office.	
START NOT ALLOWED	"Second Damage Limit" occurs.	Rotation is inoperative.	Frequency of "Disturbance" or "Mains Failure" error.	Overhaul is needed. Contact Service office. Set "Warning Damage Point" to "DISABLE" to release the error and continue operation temporarily.	Section 7.3.3 and 3.12
T. Cable Disconnect	TMS connection cable is not connected when the state "TMS Function" is set to "ENABLE".	Decelerate and stop.	1. Disconnection of the TMS connection cable. 2. Failure of the TMS connection cable. 3. Incorrect setting of the TMS function.	1. Connect the cable correctly. If the cable connector is not locked, lock it securely. 2. Contact Service office. 3. When the TMS function is not in use, set the TMS function to "DISABLE".	Section 3.6.2 Section 3.11.3
TMS Higher Temp	TMS temperature control error (when the TMS unit detection temperature becomes higher than the setting value by 10°C (+18°F) or more.	Decelerate and stop.	1. Cooling failure of TMS unit. 2. Failure of TMS unit.	1. Connect the electromagnetic cooling water valve correctly. Check the volume of water and water temperature. 2. Contact Service office.	Instruction manual(B)

<sup>\*1</sup> The driver output stops and the rotor continues rotating by inertia. It may take several hours to stop. To stop the STP pump quickly, close the vacuum valve at the outlet port flange and introduce gas from the purge port into the STP pump.

Table 43 - Error messages after self test (continued)

SCU-1600 Control Unit for Turbomolecular Pump

LCD Messages	Occurrence condition	Pump operation	Probable causes	Countermeasures	Referred section
TMS Lower Temp	TMS temperature control error (when the TMS unit detection temperature becomes lower than the setting value by 10°C (-18°F) or more. Error is not detected for a certain time after the STP pump starts.	Decelerate and stop.	1. Failure of the TMS heater. 2. Failure of the TMS unit.	1. Contact Service office. 2. Contact Service office.	Instruction manual(B)
TMS Sensor Lost	TMS sensor is not connected when the state "TMS Function" is "ENABLE".	Decelerate and stop.	1. Disconnection of the TMS sensor. 2. Incorrect setting of the TMS function. 3. Disconnection of the TMS connection cable. 4. Failure of the TMS connection cable.	1. Contact Service office. 2. When the TMS function is not in use, set the TMS function to "DISABLE". 3. Connect the cable correctly. If the cable connector is not locked, lock it securely. 4. Contact Service office.	3.11.3 3.6.2
Tuning Error 1 : : Tuning Error 9	Tuning failure.	Touch down. The magnetic bearing output stops and the rotor is descended on the touch down bearing. Rotation is inoperative.	1. Failure of the STP pump. 2. Failure of the SCU-1600.	Perform tuning after power ON/OFF operation. When the error is displayed after tuning, contact Service office.	3.9.1

Table 44 - Error messages after self test (continued)

**SCU-1600 Control Unit for Turbomolecular Pump**

**7.6 When error message is not displayed on LCD**

When the "FAILURE" LED illuminates and the LCD displays an error message, refer to Table 38 to Table 44.

**7.6.1 Abnormalities when powering ON**

No.	Symptom	Probable cause	Countermeasures	Referred section
1	The "POWER" LED does not illuminate.	Incorrect connection of power cable.	Connect the power cable correctly.	Section 3.6.3
		Abnormal power voltage.	Set the voltage to rated voltage $\pm 10\%$ .	Section 2.1 Section 3.6.3
		Power failure.	Check if a power failure has occurred.	Section 7.1.1

Table 45 - Troubleshooting when powering ON

**7.6.2 Abnormalities when performing rotational operation**

No.	Symptom	Probable causes	Countermeasures	Referred section
1	The "ACCEL." LED does not illuminate.	The "MANUAL/ REMOTE" changeover switch is not in the correct position.	Slide the "MANUAL/ REMOTE" changeover switch to the correct position.	Section 3.2 Section 4.4 Section 4.5
		Rotation INHIBIT signal input pins (REMOTE X7 (1)-(5)) are open.	When not using this function, short the circuit between (1)-(5), or set "Inhibit Command" to "DISABLE". If these pins are open, the STP pump will not rotate after performing the start operation.	Section 4.5.1 Section 3.11

Table 46 - Troubleshooting when performing the STP pump start operation



7.6.3 Other abnormalities

No.	Symptom	Probable causes	Countermeasures	Referred section
1	The STP pump stops.	Rotation INHIBIT signal input pins (REMOTE X7 (1)-(5)) are open.	When not using this function, short the circuit between (1)-(5), or set "Inhibit Command" to "DISABLE". If these pins are open, the STP pump will not rotate after performing the start operation.	Section 4.5.1 Section 3.11
2	The TMS unit does not function.	Incorrect settings of TMS function.	When using the TMS unit, set "TMS Function" to "ENABLE".	Section 3.11
3	Rotation INHIBIT signal does not function correctly.	Incorrect settings of inhibit function.	When using the rotation INHIBIT signal, set "Inhibit Command" to "ENABLE".	Section 3.11

Table 47 - Troubleshooting while the STP pump is rotating

7.7 "Error Record" message display function

The SCU-1600 can display the contents of up to the last 10 errors on the LCD. However, when "\*" is displayed at the head of the message, it is not an error detected by the SCU-1600.

To view the error record, press the "SELECT" switch several times (refer to Section 3.10).

The error number of up to the last 10 errors is displayed on the upper line of the LCD in the form "Error Record n° \*/\*\*", and the error message is displayed on the lower line.

The first number of "\*\*/\*\*" shows the order of detected errors (the most recent error is number 1) and the second number shows the number of errors that have occurred up to 10. Thus, a "1/3" would denote the most recent error out of 3. Press the "UP" or "DOWN" switch to scroll through the list and display the contents of the next or previous error message in the error record. The date of the detected error is displayed with "ENTER" switch. (The "UP", "DOWN" and "ENTER" switch can also be used in Remote Mode, refer to Section 3.10.)

7.8 Maintenance and inspection

7

MAINTENANCE

	<p style="text-align: center;"><b>WARNING</b></p> <p>Before carrying out any maintenance or inspections on the STP pump and/or the SCU-1600, power off the primary power (turn the MAIN POWER "OFF"), confirm that the LED and LCD are extinguished, and then isolate (Lockout/Tagout) the electrical energy source, water and gas, and other energy sources on the vacuum equipment. Failure to do so may result in the inadvertent rotation of the STP pump which may result in an accident, an electric shock or damage to equipment. Moreover, an accident caused by water leaks or gas leak may occur.</p>
---	---

	<p style="text-align: center;"><b>WARNING</b></p> <p>DO NOT remove the connector while the pump is rotating. The voltage might be output to connector according to the rotational speed, and it causes the electric shock or the failure.</p>
---	---

<p><b>CAUTION</b></p> <p>DO NOT touch any place other those specified when performing maintenance or inspecting the pump and NEVER open any panel because it could cause shock, malfunction, or short circuit.</p>	
--	--

Power OFF the peripheral equipments such as a baking heater before performing maintenance and inspections.

Only Edwards will replace the maintenance parts and will execute repair and overhaul. Contact Service office.

**7.8.1 Cleaning**

The method of cleaning the SCU-1600 is shown below.

- Clean the outside of the SCU-1600 with a dry wipe as required.
- When dust has accumulated in the ventilation port, wipe off or vacuum it with the cleaner. In this case, dust must not enter in the SCU-1600.
- Clean off with a pure gas when dust has accumulated in the connector.
- When the label of the SCU-1600 has been damaged, contact Service office.

**7.8.2 Overhaul**

The air-cooling fan used in the SCU-1600 will deteriorate after long-term use. It is recommended to overhaul the SCU-1600 once every two or three years as a target. This overhaul includes inspection and cleaning. Overhaul costs will be at your own charge. The costs of parts that need to be replaced because of deterioration or abrasion will be at your own charge. When overhaul of the SCU-1600 is needed, contact Service office.

## 8 STORAGE, TRANSPORTATION AND DISPOSAL

### 8.1 Storage of the SCU-1600

When planning not to use the SCU-1600 over a long period (more than a few months), follow the precautions below:

1. Store the SCU-1600 in a horizontal position.
2. DO NOT store the SCU-1600 in the following areas:
  - Areas of high humidity, (if it must be stored in a place of high humidity, insulate it from the outside and use a dehumidifying agent.)
  - Areas prone to temperature extremes. High temperatures of no more than + 55 °C (131 °F), and low temperatures of less than –25 °C (13 °F).
  - Areas which will be subjected to direct sunlight.
  - Areas where corrosive gases may exist.
  - Areas subjected to water/dampness.
  - Areas subjected to excessive dust.
  - Areas with insufficient ventilation.
  - Areas subjected to strong magnetic and electric fields or radiation.
  - Areas subjected to electric noise and vibration.

### 8.2 Transporting for repair or overhaul

	<p style="text-align: center;"><b>WARNING</b></p> <p style="text-align: center;">Ensure you follow the "Return Procedure" to prevent an accident during the transportation, repair or overhaul.</p>
---	---

<p style="text-align: center;"><b>CAUTION</b></p> <p style="text-align: center;">Edwards will not be responsible for any damage or problems that may occur when returning the SCU-1600.</p>
---

Always contact Service office before returning the SCU-1600 for repairs, overhaul or other purposes.

When returning the SCU-1600 to Service office, use the original packing to prevent external damage. If you do not have the original packing, use similar or superior packaging material. "Return Procedure" and the "Malfunction Information" are in the end of the Instruction Manual. When additional sheet is needed, contact Service office.

*Note: When returning the SCU-1600 to Service office, fill in the necessary items in the "Return Declaration" and fax it to Service office.*

---

**SCU-1600 Control Unit for Turbomolecular Pump**

**8.3 Disposal**

Dispose of the SCU-1600 as industrial waste in accordance with all local and national safety and environmental standards.

*Note: Edwards will not be responsible for problems during or after disposal.*

## 9 SERVICE, SPARES AND ACCESSORIES

### 9.1 Introduction

Edwards products, spares and accessories are available from Edwards companies and from a network of distributors, which are listed on the last page of this document. A majority of these centres employ Service Engineers who have undergone comprehensive Edwards training courses. Order spare parts and accessories from your nearest Edwards company or distributor. When you order, state for each part required:

- Model and Item number of your equipment
- Serial number (if any)
- Item number and description of part

### 9.2 Service

Edwards products are supported by a world-wide network of Edwards Service office. Each Service office offers a wide range of options including: equipment decontamination; service exchange; repair; rebuild and testing to factory specifications. Equipment, which has been serviced, repaired or rebuilt, is returned with a full warranty.

Your local Service office can also provide Edwards engineers to support on-site maintenance, service or repair of your equipment.

For more information about service options, contact your nearest Service office or Edwards.

### 9.3 Spares

Air-cooling fan: When exchanging, contact Service Office. Air-cooling fan should be replaced in Service office.

The possession periods of maintenance parts is for at least 7 years after the products is discontinued.

Contact Service office, when replacement is required.

**SCU-1600 Control Unit for Turbomolecular Pump**

**9.4 Accessories**

The following is a list of accessories that can be purchased by contacting Edwards.

<b>Items</b>	<b>Application purpose</b>	<b>Remarks</b>
Instruction Manual (A) <sup>*1</sup>	Generic Instruction Manual	
Instruction Manual (B) <sup>*1</sup>	Pump Specific Information	
Instruction Manual (C) <sup>*1</sup>	Control unit Instruction Manual applicable to your STP pump	This manual
STP pump	STP pump	Refer to the STP pump Instruction Manual (B) for the applicable STP control unit.
Power cable	Primary input power	Standard cable length is 5 m. 10 m and 20 m versions are available. Contact Edwards for further information.
STP connection cable	Connection cable between the STP pump and the STP control unit	Standard cable length is 5m. 10 m and 20 m versions are available. Contact Edwards for further information.
TMS unit <sup>*2</sup>	Control the STP pump temperature	
Air-cooling unit <sup>*2</sup>	For cooling the STP pump	
Baking heater <sup>*2</sup>	For baking the STP pump	

<sup>\*1</sup> STP pump consists of the three-volumed Instruction Manuals.

<sup>\*2</sup> Optional accessory

For more information, contact the nearest Service Office.

---

**Manufacturer:**

**Edwards Japan Limited**

1078-1, Yoshihashi, Yachiyo-shi, Chiba 276-8523 JAPAN

Telephone:	Domestic	047-458-8822
	International	+81-47-458-8822
Facsimile:	Domestic	047-458-8833
	International	+81-47-458-8833